

-Studio-

8WOOFER/P LOW FREQUENCY

This 8" bass loudspeaker has its parameters optimised for a clean bass reproduction. It features a die cast aluminium basket, polypropylene cone with rubber surround and long excursion voice coil. This model may be fitted into bass-reflex or closed enclosures in high quality multi-way systems such as studio monitors and domestic cabinets.

Modelo de 8" con unas características excepcionales para alta fidelidad: membrana de polipropileno y suspensión de goma de gran elongación, chasis de aluminio fundido y estructura magnética de gran tamaño. El resultado son unos bajos de gran impacto y unos medios nitidos y naturales para recintos de tipo bass-reflex o herméticos.



PREDICTED LOW FREQUENCY RESPONSE • Bass-reflex cabinet, Vb=25.00 l, fb=30.0 Hz

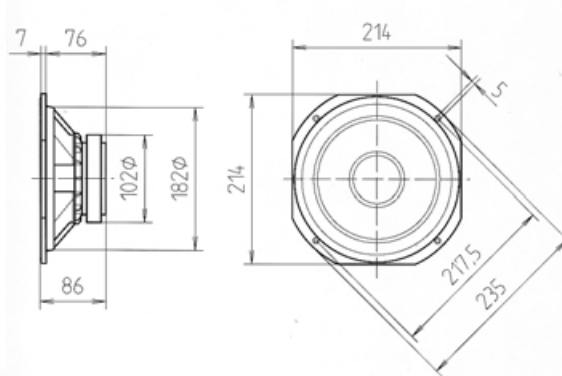
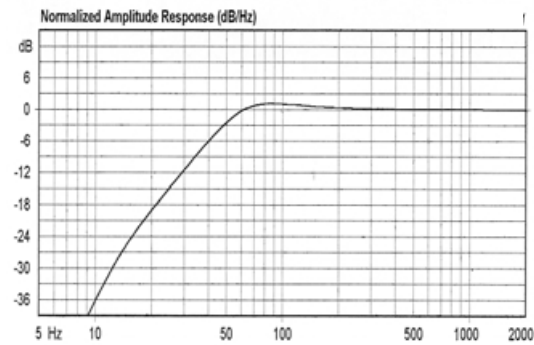

SPECIFICATIONS

Nominal diameter	200 mm. 8 in.
Rated impedance	8 ohms.
Power capacity*	50 w RMS
Program Power	100 Watts.
Sensitivity	92 dB, 2.83v @ 1m @ 2π
Frequency range	30-3500 Hz
Recom. enclosure vol.	20/50 l. 0.7/1.77 ft. ³
Voice coil diameter	25.8 mm. 1 in.
Magnetic assembly weight	1 kg. 2.2 lb.
BL factor	7.1 N/A
Moving mass	0.02 kg.
Voice coil length	15 mm.
Air gap height	6 mm.
X damage (peak to peak)	20 mm.

MOUNTING INFORMATION

Overall dimensions	214 x 214 mm.
Bolt circle diameter	217.5 mm. 8.56 in.
Baffle cutout diameter:	
-Front mount	182 mm. 7.16 in.
-Rear mount	185 mm. 7.28 in.
Depth	86 mm. 3.38 in.
Volume displaced by driver	1.5 l. 0.056 ft. ³
Net weight	1.5 kg. 3.3 lb.
Shipping weight	2.46 kg. 5.53 lb.

MATERIALS

Basket	Die Cast aluminium
Cone	Polypropylene
Surround	Rubber
Voice coil	Copper
Magnet	Ferrite

FREQUENCY RESPONSE & DISTORTION CURVES, MAGN. On axis, 1w @ 1m.

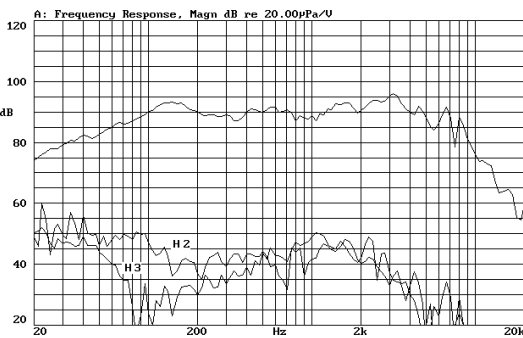

TIME RESPONSE, MAGN.

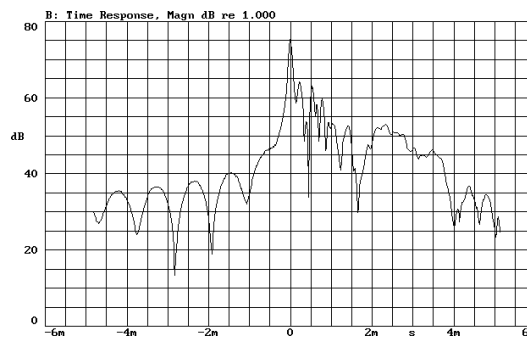

FREQUENCY RESPONSE, PHASE. On axis, 1w @ 1m.

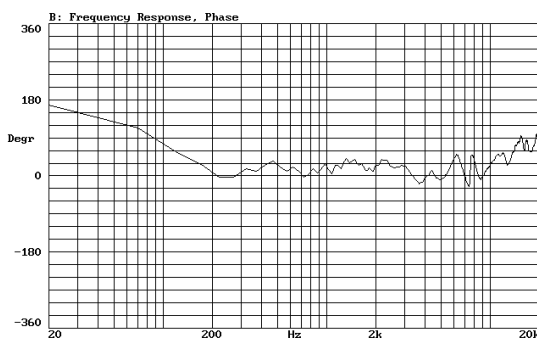

FREE AIR IMPEDANCE CURVE

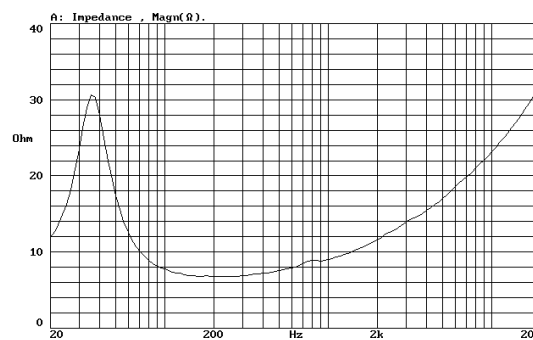

THIELE-SMALL PARAMETERS**

Resonant Frequency, fs	35 Hz
D.C. Voice Coil Resistance, Re	5.37 ohms.
Mechanical Quality Factor, Qms	2.33
Electrical Quality Factor, Qes	0.47
Total Quality Factor, Qts	0.38
Equivalent Air Volume to Cms, Vas	75 l
Mechanical Compliance, Cms	940.2 μm/N
Mechanical Resistance, Rms	1.97 kg/s
Efficiency, ηo (%)	0.6
Effective Surface Area, Sd(m ²)	0.022 m ²
Maximum Displacement, Xmax	4.5 mm.
Displacement Volume, Vd	100 cm. ³
Voice Coil Inductance, Le @ 1kHz	0.6 mH

VOICE COIL INDUCTANCE CURVE

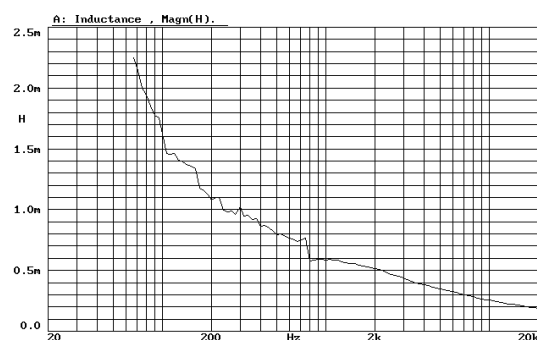

Re + Red(w) CURVE

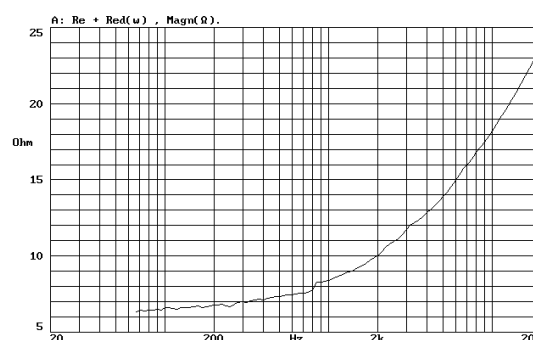

NOTES

*The power capacity corresponds to the RMS maximum value that can dissipate the loudspeaker when a sinus signal is applied for a period of at least two hours. Program power is defined as the transducer's ability to handle normal music program material.

** T-S parameters are measured after an exercise period using a preconditioning power test, using a velocity-current laser transducer, and will reflect the long term parameters, once the loudspeaker has been working for a short period of time.

NOTAS

*La potencia admisible corresponde a la máxima potencia RMS que puede disipar el altavoz durante al menos dos horas, cuando se le aplica una señal senoidal determinada. Por potencia programa se entiende la capacidad del altavoz en el manejo de señales transitorias, como sería el proporcionado por el contenido de un pasaje musical normal.

* Los parámetros T-S han sido medidos después de un periodo de fatiga y estabilización de las suspensiones, mediante transductor laser de velocidad-corriente, y son el reflejo de los parámetros a largo plazo del altavoz, una vez éste haya sido instalado y haya trabajado en un corto espacio de tiempo.