



MPC X / X SE

MPC LIVE

MPC LIVE II

MPC ONE / ONE+

MPC KEY 61 / KEY 37

MPC TOUCH

MPC STUDIO

## **User Guide**

English

Manual Version 2.15

# Table of Contents

|  |           |  |           |
|--|-----------|--|-----------|
| <b>Introduction .....</b>                              | <b>9</b>  | <b>MPC One / MPC One+ .....</b>        | <b>27</b> |
| <b>System Requirements &amp; Product Support .....</b> | <b>9</b>  | Top Panel .....                        | 27        |
| <b>About This User Guide .....</b>                     | <b>9</b>  | Navigation & Data Entry Controls ..... | 26        |
| <b>Important Notes .....</b>                           | <b>10</b> | Pad & Q-Link Controls .....            | 28        |
| <b>Setup .....</b>                                     | <b>10</b> | Mode & View Controls .....             | 28        |
| 1. Connection .....                                    | 10        | Transport & Recording Controls.....    | 29        |
| 2. Installation.....                                   | 11        | Front Panel .....                      | 30        |
| 3. Getting Started .....                               | 11        | Rear Panel .....                       | 30        |
| <b>Features .....</b>                                  | <b>12</b> | <b>MPC Key 61 .....</b>                | <b>31</b> |
| <b>Touchscreens.....</b>                               | <b>12</b> | Top Panel .....                        | 31        |
| <b>MPC X / MPC X Special Edition.....</b>              | <b>13</b> | Rear Panel .....                       | 35        |
| Top Panel.....   | 13        | <b>MPC Key 37 .....</b>                | <b>36</b> |
| Navigation & Data Entry Controls .....                 | 13        | Top Panel .....                        | 36        |
| Pad & Q-Link Controls .....                            | 14        | Rear Panel .....                       | 40        |
| Mode & View Controls .....                             | 15        | <b>MPC Studio mk2.....</b>             | <b>42</b> |
| Transport & Recording Controls.....                    | 16        | Top Panel .....                        | 42        |
| I/O & Level Controls.....                              | 17        | Navigation & Data Entry Controls ..... | 42        |
| Front Panel .....                                      | 18        | Pad & Touch Strip Controls .....       | 42        |
| Rear Panel .....                                       | 19        | Mode & View Controls .....             | 43        |
| <b>MPC Live.....</b>                                   | <b>20</b> | Transport & Recording Controls.....    | 44        |
| Top Panel.....   | 20        | Rear Panel .....                       | 45        |
| Rear Panel .....                                       | 22        | <b>MPC Touch.....</b>                  | <b>46</b> |
| <b>MPC Live II.....</b>                                | <b>23</b> | Top Panel .....                        | 46        |
| Top Panel.....   | 23        | Rear Panel .....                       | 48        |
| Rear Panel .....                                       | 26        | <b>Basic Concepts.....</b>             | <b>49</b> |

|   |           |
|---|-----------|
| <b>Tutorial .....</b>                     | <b>50</b> |
| <b>Starting Up.....</b>                   | <b>50</b> |
| <b>Creating a Drum Kit.....</b>           | <b>50</b> |
| <b>Creating a Drum Sequence.....</b>      | <b>52</b> |
| <b>Saving &amp; Renaming.....</b>         | <b>53</b> |
| <b>Editing Note Events .....</b>          | <b>55</b> |
| <b>Making Basic Sound Edits .....</b>     | <b>57</b> |
| <b>Creating a Bass Track.....</b>         | <b>59</b> |
| <b>Recording an Audio Track .....</b>     | <b>62</b> |
| <b>Creating a Song .....</b>              | <b>63</b> |
| <b>Exporting the Song.....</b>            | <b>64</b> |
| <b>Other Features Explained .....</b>     | <b>65</b> |
| Step Sequencer .....                      | 65        |
| Drum Loops & Chop Mode.....               | 66        |
| Pad Muting & Track Muting.....            | 68        |
| Sampling (Recording) .....                | 70        |
| Sample Editing.....                       | 72        |
| Recording Automation with the XY Pad..... | 74        |
| Using MPC as a Controller.....            | 75        |

|                               |           |
|-------------------------------|-----------|
| <b>Operation.....</b>         | <b>76</b> |
| <b>General Features .....</b> | <b>77</b> |
| Control Types.....            | 77        |
| Knobs .....                   | 77        |
| Parameter Values .....        | 77        |
| Drop-Down Menus / Lists.....  | 78        |
| Selectors .....               | 78        |
| Buttons .....                 | 79        |
| Checkboxes .....              | 79        |
| Tabs.....                     | 79        |
| Sliders .....                 | 79        |
| Envelopes.....                | 80        |
| Grid View Tools .....         | 81        |
| Audio Edit Tools .....        | 82        |
| Programs.....                 | 83        |
| About Programs .....          | 83        |
| Drum Programs.....            | 84        |
| Plugin Programs.....          | 86        |
| Keygroup Programs .....       | 87        |
| Clip Programs .....           | 88        |
| MIDI Programs .....           | 90        |
| CV Programs.....              | 91        |
| Menu.....                     | 92        |
| Save.....                     | 93        |
| Preferences .....             | 95        |
| Info .....                    | 95        |
| Activate Plugins .....        | 94        |
| Wi-Fi.....                    | 96        |
| Ethernet.....                 | 96        |
| Bluetooth .....               | 96        |
| Audio Device.....             | 96        |
| MIDI / Sync.....              | 97        |
| Hardware.....                 | 97        |
| Sequencer .....               | 98        |
| Project Defaults.....         | 99        |
| Project Load/Save .....       | 100       |
| Record/Export .....           | 100       |
| General .....                 | 100       |
| Splice .....                  | 102       |
| Sync.....                     | 103       |
| Undo History .....            | 103       |
| Tuner.....                    | 103       |
| MIDI Monitor.....             | 104       |
| Mode.....                     | 104       |
| System Resources .....        | 105       |

|                                     |            |                                      |            |
|-------------------------------------|------------|--------------------------------------|------------|
| Time Counter/Locate.....            | 106        | XYFX Mode .....                      | 186        |
| Timing Correct (TC) .....           | 108        | Sample Edit Mode.....                | 189        |
| Metronome (Click/Metro).....        | 110        | Settings.....                        | 191        |
| Automation .....                    | 111        | Trim Mode.....                       | 192        |
| Global.....                         | 111        | Assigning Samples.....               | 196        |
| Programs & Audio Tracks .....       | 111        | Processing Slices & Samples .....    | 198        |
| 16 Level .....                      | 112        | Chop Mode .....                      | 203        |
| Erase.....                          | 113        | Converting or Assigning Slices ..... | 206        |
| Effects.....                        | 114        | Processing Slices.....               | 209        |
| Overview .....                      | 114        | Program Mode .....                   | 213        |
| Insert Effects .....                | 116        | Assigning Samples.....               | 216        |
| Pads.....                           | 116        | Processing Slices.....               | 217        |
| Keygroups .....                     | 118        | <b>Program Edit Mode .....</b>       | <b>221</b> |
| Audio Tracks.....                   | 120        | Drum Programs.....                   | 221        |
| Programs.....                       | 121        | Global .....                         | 225        |
| Submixes.....                       | 123        | Samples .....                        | 227        |
| Main Outputs .....                  | 124        | Envelopes.....                       | 235        |
| Send/Return Effects .....           | 125        | LFO .....                            | 238        |
| Pads.....                           | 126        | Modulations .....                    | 239        |
| Keygroups .....                     | 127        | Effects .....                        | 240        |
| Audio Tracks.....                   | 128        | Keygroup Programs .....              | 242        |
| Programs.....                       | 128        | Global .....                         | 244        |
| Submixes.....                       | 129        | Samples .....                        | 247        |
| Audio Mixdown.....                  | 130        | Envelopes.....                       | 254        |
| Battery Usage .....                 | 131        | LFO .....                            | 257        |
| Standalone vs. Controller Mode..... | 132        | Porta / Mod .....                    | 258        |
| <b>Modes.....</b>                   | <b>134</b> | Effects .....                        | 259        |
| Main Mode.....                      | 135        | Clip Programs .....                  | 261        |
| Sequence Section .....              | 140        | Program .....                        | 263        |
| Track Section .....                 | 148        | Pad.....                             | 264        |
| Program Section .....               | 157        | Plugin Programs.....                 | 267        |
| Grid View .....                     | 163        | MIDI Programs .....                  | 268        |
| Audio Edit Mode .....               | 168        | CV Programs.....                     | 269        |
| Track View .....                    | 177        | Anatomy of an Envelope.....          | 270        |
| MIDI Tracks .....                   | 179        | <b>List Edit Mode .....</b>          | <b>271</b> |
| Audio Tracks .....                  | 181        | <b>Browser .....</b>                 | <b>275</b> |
| Step Sequencer.....                 | 182        | Browse.....                          | 275        |
|                                     |            | Sample Assign .....                  | 278        |
|                                     |            | <b>Sampler .....</b>                 | <b>279</b> |
|                                     |            | Sample.....                          | 282        |
|                                     |            | Slice .....                          | 284        |
|                                     |            | Pad Tap .....                        | 285        |
|                                     |            | Pad Hold.....                        | 286        |
|                                     |            | Auto Sampler .....                   | 287        |

Looper.....288

Pad Mixer.....293

    Levels..... 295

    Panning..... 295

    Mute..... 296

    Send Effects..... 296

    Insert Effects ..... 297

    Routing ..... 297

Channel Mixer.....298

    MIDI Tracks ..... 301

    Audio Tracks ..... 302

    Programs ..... 304

    Returns ..... 306

    Submixes ..... 307

    Main Outputs..... 308

Pad Mute Mode .....309

    Pad Mute ..... 310

    Pad Group ..... 311

Track Mute Mode .....312

    Track Mute..... 313

    Track Group..... 314

Next Sequence Mode.....315

Song Mode .....317

Q-Link Edit Mode.....320

    Project..... 322

    Program/Audio Track ..... 324

    Pad Scene ..... 327

    Pad Parameter ..... 328

    Screen..... 329

Pad Color Mode .....330

MIDI Control Mode .....332

    Pads ..... 333

    Buttons ..... 334

    Q-Link Knobs ..... 335

    XY Pad..... 336

    MIDI Learn..... 337

Keyboard Control .....339

Ableton Control Mode .....341

Pad Perform Mode .....341

**Appendix..... 344**

**Effects & Parameters ..... 344**

    Delay/Reverb..... 344

    Dynamics..... 347

    EQ/Filter..... 351

    Harmonic ..... 357

    Modulation ..... 363

    Vocal..... 368

**Glossary..... 375**

**SATA Drive Installation ..... 380**

**MIDI Machine Control (MMC) ..... 381**

**Technical Specifications..... 382**

    MPC X / MPC X Special Edition..... 382

    MPC Live ..... 385

    MPC Live II ..... 387

    MPC One / MPC One+..... 390

    MPC Key 61 ..... 392

    MPC Key 37 ..... 390

    MPC Studio mk2 ..... 397

    MPC Touch ..... 398

**Trademarks & Licenses ..... 399**

|   |            |   |            |
|---|------------|---|------------|
| <b>Addenda .....</b>                      | <b>400</b> | <b>Updates in MPC 2.5 .....</b>         | <b>446</b> |
| <b>Updates in MPC 2.1 .....</b>           | <b>400</b> | New Features .....                      | 446        |
| New Features.....                         | 400        | Splice Integration.....                 | 446        |
| Exporting Expansions .....                | 400        | Browser Audition Warp and Sync .....    | 447        |
| Snap: Absolute & Relative.....            | 401        |   |            |
| List Edit Settings: Auto-Advance.....     | 401        | <b>Updates in MPC 2.6.....</b>          | <b>448</b> |
| Pitch Quantization .....                  | 402        | New Features .....                      | 448        |
| Step Sequencer: Velocity Adjustment via   |            | Ableton Live Set Export .....           | 448        |
| Q-Links .....                             | 403        | Erase Parameters .....                  | 448        |
| Pad Perform Mode: User Progressions ..... | 403        | Grid Automation Lanes.....              | 449        |
| Faster Attack for Amp Envelopes .....     | 403        | Step Automation .....                   | 450        |
|   |            | Submixes .....                          | 451        |
|   |            | Workflow Enhancements .....             | 451        |
| <b>Updates in MPC 2.2 .....</b>           | <b>404</b> |   |            |
| New Features.....                         | 404        | <b>Updates in MPC 2.7 .....</b>         | <b>452</b> |
| MIDI Control Mode: MIDI Learn.....        | 404        | New Features .....                      | 452        |
| Humanize .....                            | 405        | Ableton Live Control .....              | 452        |
| Generate Random Events.....               | 407        | Akai Network Driver .....               | 452        |
| Project Template .....                    | 409        | Configuring Ableton Live .....          | 452        |
|   |            | Live Control Mode.....                  | 453        |
| <b>Updates in MPC 2.3 .....</b>           | <b>410</b> | Control Bar .....                       | 453        |
| New Features.....                         | 410        | Matrix View .....                       | 454        |
| Arpeggiator .....                         | 410        | Mixer View .....                        | 455        |
| Auto Sampler .....                        | 412        | Device Control View .....               | 455        |
| Crossfade Looping .....                   | 414        | Q-Links.....                            | 455        |
| Mode Selection Shortcut .....             | 415        | MPC X Control Map.....                  | 456        |
| Pad Perform Mode: Chromatic Type.....     | 415        | MPC Live Control Map.....               | 458        |
| Q-Link Navigation Enhancements .....      | 415        | Ethernet Adapter Support.....           | 460        |
| Split Events .....                        | 416        | Improved Preferences Organization ..... | 460        |
| AIR Instrument Plugins.....               | 417        |   |            |
| AIR Bassline.....                         | 417        | <b>Updates in MPC 2.7.2.....</b>        | <b>461</b> |
| AIR Electric .....                        | 420        | New Features .....                      | 461        |
| AIR TubeSynth.....                        | 424        | MPC One Support.....                    | 461        |
| Plugin Preset Support.....                | 431        |   |            |
|   |            | <b>Updates in MPC 2.7.3.....</b>        | <b>462</b> |
| <b>Updates in MPC 2.4 .....</b>           | <b>432</b> | New Features .....                      | 462        |
| New Features.....                         | 432        | MPC Live II Support.....                | 462        |
| AIR FX Bundle .....                       | 432        | MPC Live II Ableton Live Control.....   | 462        |
| AIR Instrument Layouts.....               | 443        | MPC Live II Control Map .....           | 462        |
| Clip Program Improvements .....           | 444        |   |            |
| FLAC and OGG Support.....                 | 444        |   |            |
| Mother Ducker .....                       | 444        |   |            |
| Next Sequence Mode.....                   | 445        |   |            |
| Additional Transport Controls .....       | 445        |   |            |

|   |            |   |            |
|---|------------|---|------------|
| <b>Updates in MPC 2.8 .....</b>           | <b>464</b> | <b>Updates in MPC 2.11 .....</b>            | <b>508</b> |
| New Features.....                         | 464        | New Features .....                          | 508        |
| MIDI Improvements .....                   | 464        | MPC Key 61 Support .....                    | 508        |
| Copy Pads .....                           | 465        | Sounds and Favorites .....                  | 511        |
| Custom Progressions .....                 | 466        | New Plugin Instruments .....                | 513        |
| Edit Pad MIDI Note Map .....              | 466        | Insert Effect Updates .....                 | 515        |
| Global Automation Button.....             | 467        | Menu Editing and Shortcuts Panel .....      | 517        |
| Global Timing Correct On/Off.....         | 467        | Built-In Tuner .....                        | 518        |
| Main Button Track Select.....             | 467        | Note Probability and Note Ratchet.....      | 518        |
| Expanded Pad Perform .....                | 467        | Pad Perform and 16 Levels Enhancements..... | 519        |
| Retrospective Record .....                | 468        | Track MIDI Perform Settings .....           | 520        |
| Single or Multi Record Arm .....          | 468        | MIDI Control Mode Updates .....             | 520        |
| Q-Link Overlay.....                       | 468        | Workflow Improvements and Enhancements ...  | 520        |
| <br>                                      |            | <br>  |            |
| <b>Updates in MPC 2.9 .....</b>           | <b>469</b> | <b>Updates in MPC 2.11.6.....</b>           | <b>522</b> |
| New Features.....                         | 469        | New Features .....                          | 522        |
| AIR DrumSynth.....                        | 469        | AIR Flavor Pro and Mini D.....              | 522        |
| <br>                                      |            | Workflow Improvements .....                 | 522        |
| <b>Updates in MPC 2.10 .....</b>          | <b>473</b> | <br>  |            |
| New Features.....                         | 473        | <b>Updates in MPC 2.11.7.....</b>           | <b>523</b> |
| Four New Instrument Plugins.....          | 473        | New Features .....                          | 523        |
| AIR Hype .....                            | 469        | VST Preset Loading.....                     | 523        |
| AIR Mellotron .....                       | 474        | <br>  |            |
| AIR Solina.....                           | 477        | <b>Updates in MPC 2.11.9.....</b>           | <b>524</b> |
| WayOutWare Odyssey .....                  | 482        | New Features .....                          | 524        |
| AIR FX Bundle .....                       | 491        | MPC X Special Edition Support.....          | 524        |
| Standalone Audio Interface Support .....  | 495        | <br>  |            |
| FX Racks.....                             | 495        | <b>Updates in MPC 2.12.....</b>             | <b>525</b> |
| Drum and Keygroup Program Improvements... | 495        | New Features .....                          | 525        |
| File Browser Enhancements.....            | 497        | MPC One+ Support.....                       | 525        |
| Key Detection.....                        | 497        | <br>  |            |
| Expanded CV Program Operation.....        | 497        | <b>Updates in MPC 2.12.2.....</b>           | <b>526</b> |
| MIDI Program Renaming.....                | 498        | New Features .....                          | 526        |
| MIDI Monitor.....                         | 498        | New Plugin Effects and Improvements.....    | 526        |
| Undo History .....                        | 498        | <br>  |            |
| <br>                                      |            | <b>Updates in MPC 2.13.....</b>             | <b>528</b> |
| <b>Updates in MPC 2.10.1 .....</b>        | <b>499</b> | New Features .....                          | 528        |
| New Features.....                         | 499        | MPC Key 37 Support .....                    | 528        |
| MPC Studio mk2 Support.....               | 499        | Feature Improvements.....                   | 528        |
| Touch Strip and Touch FX .....            | 499        |   |            |

**Updates in MPC 2.15 .....529**

New Features.....529

    Stem Separation..... 529

    Edit All Layers..... 531



## Introduction

Thank you for purchasing your MPC. At Akai Professional, we know how serious music is to you. That's why we design our equipment with only one thing in mind—to make your performance the best it can be.

This user guide explains how to create music using **MPC X**, **MPC X Special Edition**, **MPC Live**, **MPC Live II**, **MPC One**, **MPC One+**, **MPC Key 61**, **MPC Key 37**, **MPC Studio mk2** and **MPC Touch**. There is similar documentation available for MPC products that use an LCD and for the MPC software application. To view these user guides, click the **Help** menu in the MPC software, select **MPC Help**, and select an option.

**Note:** The MPC Studio mk2 hardware acts primarily as a controller for the MPC software. Descriptions in this guide will assist MPC Studio mk2 users in using their hardware to access different features of the MPC software. To learn more about how to use these software features, consult the MPC software User Guide.

Welcome to the MPC family.

**Akai Professional**

## System Requirements & Product Support

For the latest information about this product (system requirements, compatibility information, etc.) and product registration, visit [akaipro.com](http://akaipro.com).

For additional support, visit [akaipro.com/support](http://akaipro.com/support).

## About This User Guide

This manual should help you get familiar with using your **MPC X**, **MPC X Special Edition**, **MPC Live**, **MPC Live II**, **MPC One**, **MPC One+**, **MPC Key 61**, **MPC Key 37**, **MPC Studio mk2** or **MPC Touch** (from here on, "MPC hardware" unless otherwise noted). For consistency, the terminology throughout is based on the MPC nomenclature. We also used specific formatting to indicate particular topics of significance:

**Important/Note/Tip:** Important or helpful information on a given topic.

Names of buttons, controls, parameters, settings, and other options are written in **bold** characters throughout the manual.

**Examples:** Press the **Play Start** button.

Turn **Q-Link Knob 4**.

Tap the **Mute** button.

The **Velocity** ranges from **0** to **127**.

Set the **Sample Play** selector to **One Shot**.

Tap **BPM**, and then use the numeric keypad to enter **120** as the tempo.

Some parts of this manual refer to other relevant chapters or sections, which are cited in **bold, italic blue** characters. Click the text to skip immediately to that section.

**Examples:** Read the **Important Notes** section before proceeding.

For more information about installing the necessary drivers and software, see **Setup > 2. Installation**.

To learn more about using send effects, see **General Features > Effects > Send/Return Effects**.

## Important Notes

Read the included safety & warranty manual before using your MPC hardware.

Before getting started and connecting devices to your MPC hardware or turning the hardware on/off, make sure all devices are switched off.

**To use your MPC hardware in Controller Mode** (to control the MPC software):

Before installing the MPC software, make sure your computer meets the system requirements described at [akaipro.com](http://akaipro.com). This applies whether you'll use MPC software as your host software or as a plugin in another digital audio workstation (DAW).

Before connecting your MPC hardware to your computer, install the drivers and software. Visit [akaipro.com](http://akaipro.com) to download the latest versions. Refer to the [2. Installation](#) section for more information.

## Setup

### 1. Connection

Here is just an example of how to use MPC X in your setup. Items not listed under *Introduction > Box Contents* of your included Quickstart Guide are sold separately.

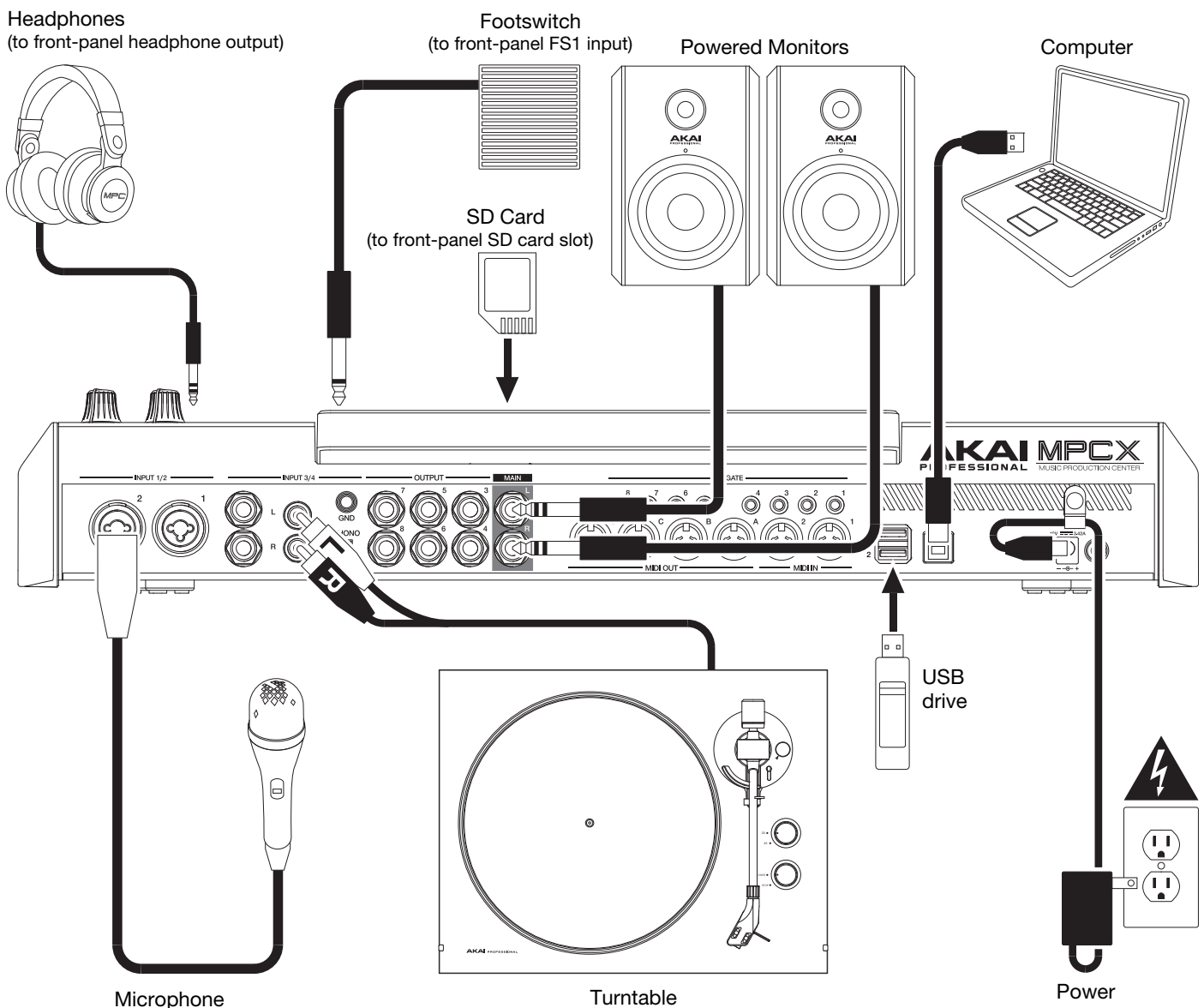

Remember to remove the protective film from your MPC hardware touchscreen!

**To use your MPC hardware in Standalone Mode**, just connect it to a power outlet using the included power adapter, and power it on!

**Note:** We highly recommend checking [akaipro.com](http://akaipro.com) for any available updates to the MPC software/firmware and/or drivers.

**To use your MPC hardware in Controller Mode**, continue to Step [2. Installation](#).

## 2. Installation

**To use your MPC hardware in Controller Mode** (to control the MPC software), **follow these steps to download and install the required drivers & software:**

1. Go to [akaipro.com](http://akaipro.com) and register your product. If you don't have an Akai Professional account yet, you will be prompted to create one.
2. In your Akai Professional account, download the MPC software package.
3. Open the file and double-click the installer application.
4. Follow the on-screen instructions to complete the installation.

**Note:** By default, the MPC software will be installed in [your hard drive]\Program Files\Akai Pro\MPC (Windows®) or Applications (macOS®). You can also create a shortcut on your Desktop.

## 3. Getting Started

1. Power on your MPC hardware.
2. On your computer, open the **MPC** software.
3. Follow the on-screen instructions to authorize your version of MPC.
4. You will need an iLok account to complete this. You can create an account at [ilok.com](http://ilok.com).

Make a note of the PACE code in your account, and enter it when asked for it during the authorization/unlock process.

5. On your MPC hardware, check the upper-right corner of the touchscreen:
  - If there is a **monitor/cable icon**, then your MPC hardware is already in Controller Mode. Continue to **Step 6**.
  - If there is a **chip icon**, then your MPC hardware is in Standalone Mode. Follow these steps:
    - i. Press **Menu** to enter the Menu.
    - ii. Tap the **MPC chip icon** in the upper-right corner.
    - iii. In the **Enter Controller Mode** window that appears, tap **Controller Mode**. **Looking for computer** may appear briefly on the screen before your MPC hardware recognizes the USB connection as a controller.



6. In the MPC software, click the **Edit** menu, and select **Preferences**. Click the **Audio** tab and select the sound card you want to use. Click **OK** when you are done.

### Important:

We highly recommend using your MPC hardware's sound card (**Akai Pro MPC X/Live/Live II/One/Key 61/Touch ASIO**). If you need to use the internal sound card on a Windows computer, we recommend downloading the latest ASIO4ALL driver at [asio4all.com](http://asio4all.com).

To view the MPC software User Guide, click the **Help** menu in the MPC software, select **MPC Help**, and select **MPC User Manual**.

# Features

This chapter explains the features and functions of each MPC model with a touchscreen: *MPC X*, *MPC Live*, *MPC Live II*, *MPC One*, *MPC Key 61*, *MPC Key 37*, and *MPC Touch*.

**Note:** If you are using the *MPC Studio mk2*, the display does not function as a touchscreen but can be used in conjunction with the software to select tracks, programs, and files, as well as edit samples or change project parameters. To learn more about how to use the MPC software, consult the MPC software User Guide. This can be accessed by clicking the **Help** menu in the MPC software, selecting **MPC Help**, and selecting **MPC User Manual**.

# Touchscreens

Here is some general information about how to use the touchscreen on your MPC:

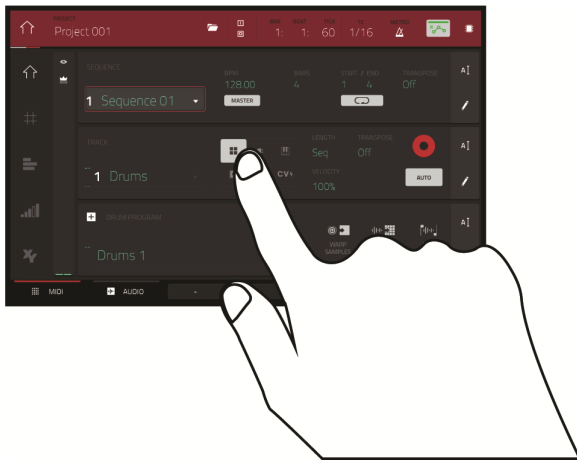

Tap a button or option to select it. Use the **data dial** or **-/+** buttons to change its setting or value.

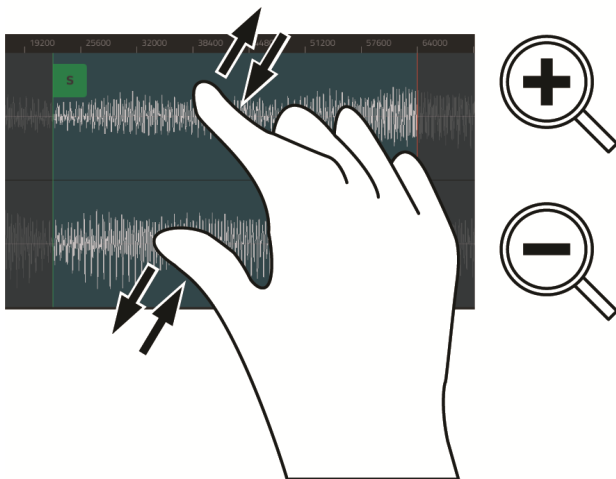

Spread two fingers to zoom in (into a section of a waveform, for example). Pinch two fingers to zoom out.

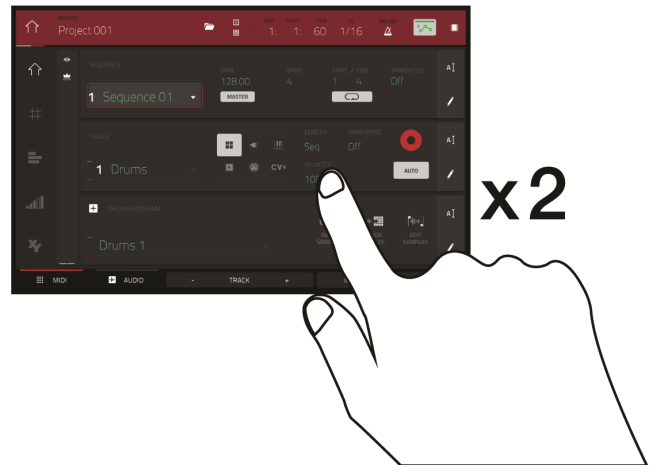

Double-tap a button to access advanced editing options. In some cases, this will show a numeric keypad that you can use to enter a value (an alternative to the **data dial** or **-/+** buttons). Tap the upper-left part of the screen to return to the previous view.

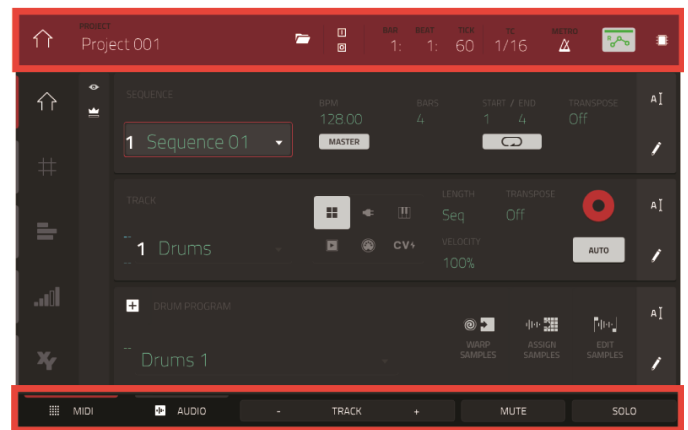

The top of the screen shows the toolbar, which contains information about the current view (often the name of the current track, sequence, playhead position, etc.). Tap an item to select it.

The bottom of the screen shows various buttons that you can use in the current view. Tap a button to press it.

**To return to a previous view**, either tap outside of the window currently on the screen or tap the left arrow (←) in the upper-left part of the screen.

MPC X / MPC X Special Edition

**Note:** Mentions of the features and functions of MPC X hardware throughout this guide also apply to the MPC X Special Edition unless otherwise noted.

Top Panel

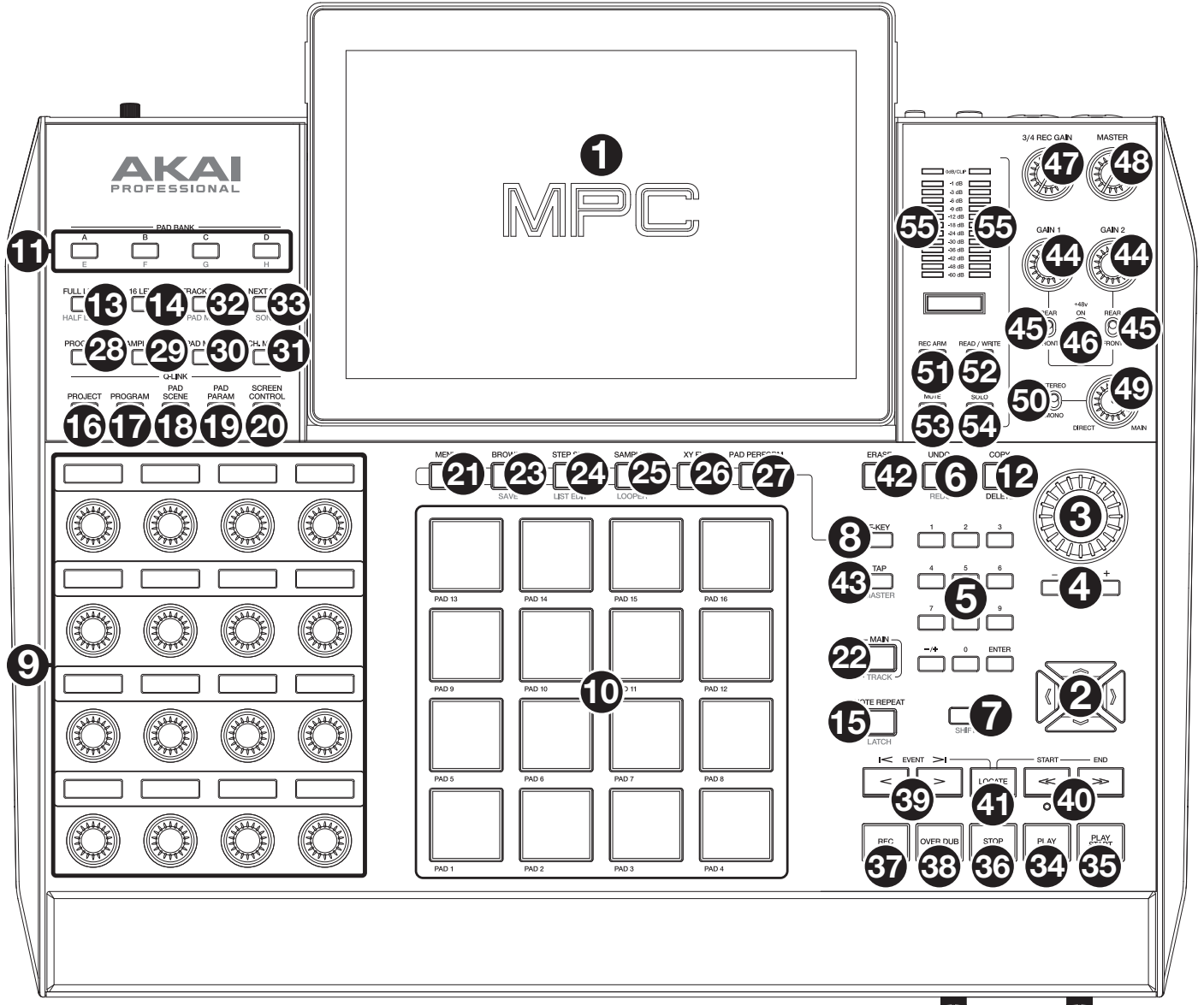

Navigation & Data Entry Controls

1. **Touchscreen:** This full-color multi-touch display shows information relevant to MPC X's current operation. Touch the touchscreen (and use the hardware controls) to control the MPC interface. See the previous [Touchscreens](#) section to learn how to use some basic functions.  
**Tip:** If you adjust the angle of the touchscreen, use the stand on its back panel to secure it in place.
2. **Cursors:** Press these buttons to navigate through the fields of menus and options shown on the screen. Press and hold **Shift** and press these buttons to zoom in or out of the Grid View or Audio Edit Mode. Press and hold **Shift** and press the **up** and **down cursors** simultaneously or the **left** and **right cursors** simultaneously to return to the default zoom setting.

3. **Data Dial:** Use this dial to scroll through the available menu options or adjust the parameter values of the selected field on the screen.
4. **-/+:** Press these buttons to increase or decrease the value of the selected field on the screen.
5. **Numeric Keypad:** If the selected field on the screen is a number, press these numbered buttons as you would on a standard numeric keypad to enter a value. Press the keypad's **Enter** to enter it. (A numeric keypad with additional operations will appear on the screen, as well.)
6. **Undo/Redo:** Press this button to undo your last action.  
Press and hold **Shift** and press this button to redo the last action you undid.
7. **Shift:** Press and hold this button to access some buttons' secondary functions (indicated by **red** writing).  
Double-press this button to see which buttons have secondary functions—the buttons will flash for a few seconds.
8. **F-Key:** Press this button to activate or deactivate the F-Key feature. When active, the six buttons under the touchscreen correspond to the options shown at the bottom edge of the screen. The F-Key button and those six buttons will be lit **red** when active. When inactive, the six buttons under the touchscreen will access their normal modes instead (**Menu, Browser, Step Seq, Sampler, XYFX, and Looper**).

## Pad & Q-Link Controls

9. **Q-Link Knobs:** Turn these touch-sensitive knobs to adjust various parameters and settings. The display strip above each knob indicates the parameter it is controlling. If the display strip shows a meter to indicate its value, you can touch or turn its Q-Link knob to temporarily show its precise numerical value.
10. **Pads:** Press these pads to trigger drum hits or other samples in your software. The pads are velocity-sensitive and pressure-sensitive, which makes them very responsive and intuitive to play. The pads will light up different colors, depending on how hard you play them (ranging from yellow at a low velocity to red at the highest velocity). You can also customize their colors.
11. **Pad Bank:** Press these buttons to access Pad Banks A–D.  
Press and hold **Shift** while pressing these buttons to access Pad Banks E–H. Alternatively, double-press one of these buttons.
12. **Copy/Delete:** Press this button to copy one pad to another. When the **From Pad** field is selected, press the “source” pad (the pad you want to copy). When the **To Pad** graphic (of all pads) is selected, press the “destination” pad. You can select multiple destination pads, and you can select pads in different pad banks. Tap **Do It** to continue or **Close** to return to the previous screen.

**Tip: To quickly copy a pad,** press and hold **Copy**, press the source pad, press the destination pad, and then release **Copy**.

Press and hold **Shift** and press this button to delete a pad's sample assignment. When the **Delete Pad** window is shown, press any pad/pads whose sample assignments you want to clear. Tap **Delete** to continue or **Cancel** to return to the previous screen.

13. **Full Level/Half Level:** Press this button to activate or deactivate the Full Level feature. When activated, the pads will always trigger their samples at the maximum velocity (**127**), regardless of how much force you use.  
Press and hold **Shift** and then press this button to activate or deactivate the Half Level feature. When activated, the pads will always trigger their samples at half-velocity (**64**).
14. **16 Level / Pad Perform:** Press this button to activate/deactivate 16 Level. When activated, the last pad that was hit will be temporarily copied to all 16 pads. The pads will now output the same note number as the initial pad, but a selectable parameter will be fixed at values that increase as the pad numbers increase (e.g., Pad 1 is the minimum, Pad 16 is the maximum), regardless of how hard you press them. In the screen that appears, use the **Type** selector to choose the parameter: **Velocity, Tune, Filter, Layer, Attack** or **Decay**. See [Operation > General Features > 16 Level](#) to learn more.

Press and hold **Shift** and press this button to enter Pad Perform mode for the pads. When activated, you can play musical scales/modes, chords or progressions using the pads while in any mode. See [Operation > Modes > Pad Perform Mode](#) to learn more.

15. **Note Repeat/Latch:** Press and hold this button, and then press a pad to trigger that pad's sample repeatedly. The rate is based on the current tempo and Time Correct settings.  
  
Press and hold **Shift** and then press this button to "latch" the Note Repeat feature. When latched, you do not have to hold the Note Repeat button for it to be activated. Press **Note Repeat** once more to unlatch it.
16. **Project:** Press this button to use the Q-Link knobs to adjust parameters related to the current project. Press and hold **Shift** and then press this button to enter the Project Q-Link Edit Mode directly. See [Operation > Modes > Q-Link Edit Mode > Project](#) to learn about this.
17. **Program:** Press this button to use the Q-Link knobs to adjust parameters of the currently selected program or audio track. Press and hold **Shift** and then press this button to enter the Program Q-Link Edit Mode directly. See [Operation > Modes > Q-Link Edit Mode > Program](#) to learn about this.
18. **Pad Scene:** Press this button to use the Q-Link knobs to adjust parameters that you have assigned for the currently selected pad. Press and hold **Shift** and then press this button to enter the Pad Scene Q-Link Edit Mode directly. See [Operation > Modes > Q-Link Edit Mode > Pad Scene](#) to learn about this.
19. **Pad Param:** Press this button to use the Q-Link knobs to adjust one parameter across all 16 pads. Each Q-Link knob corresponds to the pad with the same number and position in the 4-by-4 layout. Press and hold **Shift** and then press this button to enter the Pad Param Q-Link Edit Mode directly. See [Operation > Modes > Q-Link Edit Mode > Pad Parameter](#) to learn about this.
20. **Screen Control/Edit:** Press this button to use the Q-Link knobs to adjust parameters in the currently selected mode as shown on the screen. See [Operation > Modes > Q-Link Edit Mode > Screen](#) to learn about this.  
  
Press and hold **Shift** and then press this button to enter Q-Link Edit Mode where you can assign other parameters to the Q-Link knobs.

## Mode & View Controls

**Note:** See [Operation > Modes](#) to learn about the different modes you can access with these controls.

21. **Menu:** Press this button to open the Menu. You can tap an option in the Menu to enter that mode, view, etc.
22. **Main/Track:** Press this button to enter Main Mode.  
  
Press and hold **Shift** and then press this button to enter the Track View.
23. **Browse/Save:** Press this button to view the Browser. The Browser lets you navigate your computer's internal and external hard disks to load samples, sequences, songs, etc. Using filter buttons and user-definable folders, you can easily adapt it to your workflow. You can also preview samples before loading them.  
  
Press and hold **Shift** and press this button to save the current project (including its samples, programs, sequences, and songs).
24. **Step Seq/List Edit:** Press this button to view the Step Sequencer where you can create or edit sequences by using the pads as "step buttons," simulating the experience of a traditional step-sequencer-style drum machine.  
  
Press and hold **Shift** and press this button to view your sequences using the List Edit View instead of the Grid View.
25. **Sampler/Looper:** Press this button to view the Sampler where you can record audio samples to use in your projects.  
  
Press and hold **Shift** and press this button to view the Looper where you can record and overdub audio in real time—a great tool for live performance as well as spontaneous moments in the studio. You can export the loop as a sample to use in your project.
26. **XYFX:** Press this button to view XYFX Mode, which turns the touchscreen into an XY pad where each axis represents the range of an effect parameter. As you move touch or move your finger on the screen, the current position will determine the current value of the two parameters. You can use this mode to create interesting effect automation on your tracks.
27. **Pad Perform:** Press this button to view Pad Perform Mode where you can assign musical scales/modes, chords, or progressions to the pads for creative performance options.
28. **Prog Edit:** Press this button to view Program Edit Mode, which contains all parameters for editing your programs.
29. **Sample Edit:** Press this button to view Sample Edit Mode where you can edit your samples using various functions and processes.

30. **Pad Mixer:** Press this button to view the Pad Mixer where you can set a program's levels, stereo panning, routing, and effects.
31. **Ch. Mixer:** Press this button to view the Channel Mixer where you can set levels, stereo panning, and other settings for your tracks, programs, returns, submixes and main outputs.
32. **Track Mute/Pad Mute:** Press this button to view Track Mute Mode where you can easily mute tracks within a sequence or set mute groups for each track.  
  
Press and hold **Shift** and press this button to view Pad Mute Mode where you can easily mute pads within a program or set mute groups for each pad within a program.
33. **Next Seq/Song:** Press this button to view Next Sequence Mode where you can trigger different sequences simply by playing the pads. This is useful for live performances, letting you change a song's structure in real time.  
  
Press and hold **Shift** and press this button to view Song Mode where you can arrange sequences in a specific order and/or repetition to create songs. You can edit the structure of a song during playback for easy, on-the-fly composing.

## Transport & Recording Controls

34. **Play:** Press this button to play the sequence from the playhead's current position.
35. **Play Start:** Press this button to play the sequence from its start point.
36. **Stop:** Press this button to stop playback. You can double-press this button to silence audio that is still sounding once a note stops playing. Quickly pressing this button three times will act as a "MIDI panic" and shut off all voices and stop all audio processing.
37. **Rec:** Press this button to record-arm the sequence. Press **Play** or **Play Start** to start recording. Recording in this way (as opposed to using **Overdub**) erases the events of the current sequence. After the sequence plays through once while recording, Overdub will be enabled.
38. **Overdub:** Press this button to enable Overdub. When enabled, you can record events in a sequence without overwriting any previously recorded events. You can enable Overdub before or during recording.
39. **</> (Event |</>):** Use these buttons to move the playhead left or right, one step at a time.  
  
Press and hold **Locate** and press one of these buttons to move the playhead to the previous/next event in the sequence grid.
40. **<</>> (Start/End):** Use these buttons to move the playhead left or right, one bar at a time.  
  
Press and hold **Locate** and press one of these buttons to move the playhead to the start or end of the sequence grid.
41. **Locate:** Press and hold this button to activate the secondary functions of the </> and <</>> buttons (i.e., **Event |</>** and **Start/End**, respectively).
42. **Erase:** As a sequence is playing, press and hold this button and then press a pad to delete the note event for that pad at the current playback position. This is a quick way to delete note events from your sequence without having to stop playback. See [Operation > General Features > Erase](#) to learn more.
43. **Tap/Master (Global):** Press this button in time with the desired tempo to enter a new tempo (in BPM). You can set how many taps are required in the Preferences (see [Operation > General Features > Menu > Preferences](#) to learn how to do this).  
  
Press and hold **Shift** and press this button to set whether the currently selected sequence follows its own tempo (the button will be lit **red**) or a global tempo (the button will be lit **amber**).



## I/O & Level Controls

44. **Gain 1/2:** Use these knobs to adjust the gain of the incoming signal from **Input 1/2** on the rear panel or **Inst 1/2** on the front panel. Use the **Rear/Front** switches below the knobs to determine the input. Use the **level meter** to check the recording level. Be careful when setting this knob at higher levels, which can cause the signal to distort.
45. **Rear/Front:** Use each switch to set whether the **Gain 1/2** knob above it will control the gain of the input signal on the rear panel (**Input 1/2**) or on the front panel (**Inst 1/2**).
46. **Phantom Power (+48V):** This switch activates and deactivates phantom power for **Input 1/2**. When activated, +48V of phantom power will be supplied to both inputs. Note that most dynamic microphones do **not** require phantom power, while most condenser microphones **do**. Refer to your microphone's documentation to check if it needs phantom power.
47. **3/4 Rec Gain:** Use this knob to adjust the gain of the incoming signal from **Input 3/4** on the rear panel. Use the **level meter** to check the recording level. Be careful when setting this knob at higher levels, which can cause the signal to distort.
48. **Master (Main):** Turn this knob to adjust the volume level of the **Main L/R outputs**.
49. **Direct/Main:** Turn this knob to adjust the balance between the input and output signals in the headphones.
  - Direct** corresponds to the input signal—all devices connected to the inputs on the front and rear panels. While recording, you can turn this knob all the way to **Direct** for zero-latency direct monitoring.
  - Main** corresponds to the output signal—the signal sent from the Main L/R outputs on the rear panel. When you are **not** recording, we recommend turning this knob all the way to the **Main** position to hear the full-volume playback signal.
50. **Stereo/Mono:** Use this switch to set whether the signal in the headphones is binaural (**Stereo**) or monaural (**Mono**). When set to **Stereo**, the headphone signal will be split so that the input signal (**Direct**) is heard in the left ear while the output signal (**Main**) is heard in the right ear. When set to **Mono**, the input and output signals are blended into a single, summed mix, which is heard in both ears.
51. **Rec Arm:** Press this button to arm or disarm recording for the currently selected audio track, shown in the display strip below the **level meters** (see [Operation > General Features > Menu > Preferences](#) to learn how to set what is shown in the level meters).
52. **Read/Write:** Press this button to toggle the automation state for the program on the current track or for the current audio track between **Read** (green R) and **Write** (red W). The display strip below the **level meters** must show a program or audio track (see [Operation > General Features > Menu > Preferences](#) to learn how to set what is shown in the level meters).

Press and hold **Shift** and press this button to turn off global automation.
53. **Mute:** Press this button to mute the program, audio track, or main output shown in the display strip below the **level meters** (see [Operation > General Features > Menu > Preferences](#) to learn how to set what is shown in the level meters).
54. **Solo:** Press this button to solo the currently selected program or audio track shown in the display strip below the **level meters** (see [Operation > General Features > Menu > Preferences](#) to learn how to set what is shown in the level meters).
55. **Level Meters:** These meters indicate the level of the audio signal shown in the display strip below them. See [Operation > General Features > Menu > Preferences](#) to learn how to set what is shown in the level meters.

## Front Panel

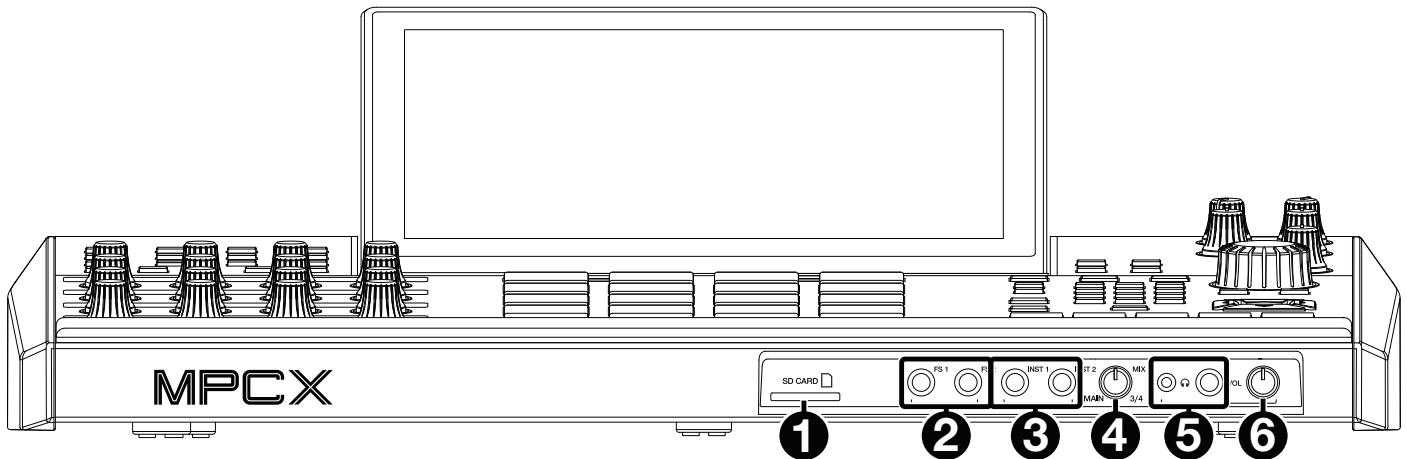

1. **SD Card Slot:** Insert a standard SD/SDHC card into this slot to access its files directly using MPC X.
2. **Footswitch Inputs (FS 1/2)** (1/4" / 6.35 mm): Connect optional 1/4" (6.35 mm) TS footswitches to these inputs.
3. **Instrument Inputs (Inst 1/2)** (1/4" / 6.35 mm): Use standard 1/4" (6.35 mm) TS cables to connect these inputs to audio sources (guitars, bass, etc.). To use each of these inputs, set the corresponding **Rear/Front** switch (below the **Gain 1/2** knob on the top panel) to **Front**.
4. **Mix Knob:** Turn this knob to adjust the balance between the **Main** and **3/4** signals in your headphones. **Main** is the signal sent from the **Main L/R outputs**. **3/4** is the signal sent from the **Outputs 3/4**.
5. **Headphone Outputs** (1/8" or 1/4" / 3.5 mm or 6.35 mm): Connect your headphones (not included) to either or both of these standard stereo outputs. Use the **Mix Knob** to determine what signal is heard in the headphones. Turn the **Headphone Volume** knob to set the volume level.
6. **Headphone Volume:** Turn this knob to adjust the volume of the headphone outputs.

## Rear Panel

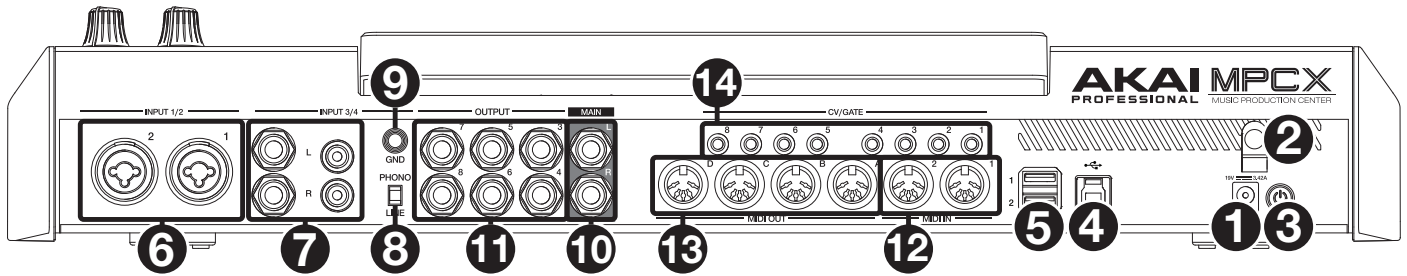

1. **Power Input:** Use the included power adapter to connect MPC X to a power outlet. This must be connected to a power outlet in order for MPC X to power on.
2. **Power Adapter Restraint:** Secure the power adapter cable to this restraint to prevent it from accidentally unplugging.
3. **Power Switch:** Press this button to turn MPC X's power on or off. While powered on, press and hold this button for 5 seconds to force MPC X to power off (similar to a computer).
4. **USB-B Port:** Use the included USB cable to connect this USB 3.0 port to an available USB 3.0 port on your computer. This connection allows MPC X to send/receive MIDI and audio data to/from the MPC software on your computer. It also allows any connected USB drives, SD cards, and drives connected to the internal SATA port to mount on your computer if MPC X is in Controller Mode (i.e., your computer can access these storage devices that are connected to your MPC X).
5. **USB-A Ports:** Connect USB flash drives to these USB ports to access their files directly using MPC X. MPC X supports read and write capability for exFAT, FAT32, NTFS, and EXT4 file systems as well as read-only capability for HFS+ file systems. (We recommend using an exFAT file system as it is the most robust one supported by both Windows and macOS.) These USB ports supply power to connected USB devices and can also be used to receive MIDI messages from external USB MIDI devices.
6. **Inputs 1/2 (XLR or 1/4" / 6.35 mm):** Use standard XLR or 1/4" (6.35 mm) TRS cables to connect these inputs to audio sources (microphone, mixer, synthesizer, etc.). To use each of these inputs, set the corresponding **Rear/Front** switch (below the **Gain 1/2** knob on the top panel) to **Rear**. Turn the **Gain 1/2** knobs to set the input level of each one.
 

**Note:** When using the XLR connection, the mic pre-amp is automatically engaged. When using a 1/4" (6.35 mm) TRS cable, the mic pre-amp is bypassed.
7. **Inputs 3/4 (1/4" / 6.35 mm or RCA):** Use standard 1/4" (6.35 mm) TRS cables or stereo RCA cables to connect these inputs to audio sources (mixer, turntable, synthesizer, etc.). To use the 1/4" (6.35 mm) inputs, set the **Phono/Line** switch to **Line**. To use the RCA inputs, set the **Phono/Line** switch to **Phono**. Turn the **3/4 Rec Gain** knob to set their input levels.
8. **Phono/Line Switch:** Set this switch to the appropriate position, depending on which **Input 3/4** connectors you want to use. If you are using the 1/4" (6.35 mm) inputs, set this switch to **Line**. If you are using the RCA inputs, set this switch to **Phono** to provide the additional amplification needed for phono-level signals.
9. **Grounding Terminal:** If you are sending a phono-level turntable signal to the **Input 3/4** RCA connectors and are hearing a low hum or buzz, it could mean that the turntable is not grounded. If the turntable has a grounding wire, connect it to this terminal.
 

**Note:** Some turntables have a grounding wire built into the RCA connection and, therefore, nothing needs to be connected to the grounding terminal.
10. **Main L/R Outputs (1/4" / 6.35 mm):** Use standard 1/4" (6.35 mm) TRS cables to connect these outputs to your speaker system. The signal sent out of these outputs is the main mix. Turn the **Master** knob to set their volume.
 

**Tip:** To route a program to these outputs, set its routing to **Out 1,2** in the **Channel Mixer** when the **Mixer** field is set to **Programs**. See [Operation > Modes > Channel Mixer](#) to learn more about this.
11. **Outputs 3/4, 5/6, 7/8 (1/4" / 6.35 mm):** Use standard 1/4" (6.35 mm) TRS cables to connect these outputs to an external mixer. The signal sent from these outputs is full-volume (**0 dB**).
 

**Tip:** To route a program to these outputs, set its routing to **Out 1,2**, **Out 5,6**, or **Out 7,8** (respectively) in the **Channel Mixer** when the **Mixer** field is set to **Programs**. See [Operation > Modes > Channel Mixer](#) to learn more about this.
12. **MIDI In:** Use standard 5-pin MIDI cables to connect these inputs to the MIDI outputs of optional external MIDI devices.
13. **MIDI Out:** Use standard 5-pin MIDI cables to connect these outputs to the MIDI inputs of optional external MIDI devices.
14. **CV/Gate Out:** Use standard 1/8" (3.5 mm) TS cables to connect these outputs to optional external sequencers. MPC X will send control voltage (CV) and/or Gate data over this connection.

## MPC Live

## Top Panel

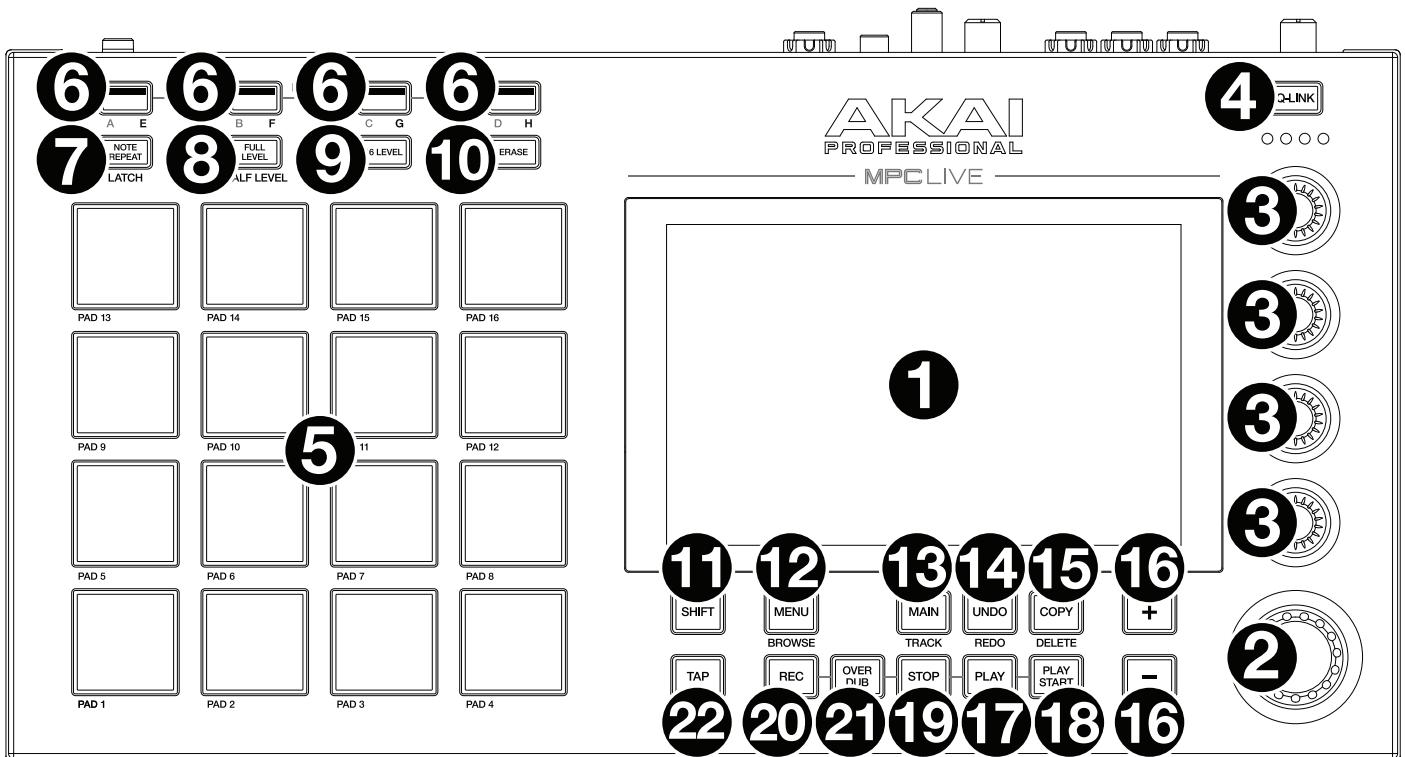

- 1. Touchscreen:** This full-color multi-touch display shows information relevant to MPC Live's current operation. Touch the touchscreen (and use the hardware controls) to control the MPC interface. See the previous [Touchscreens](#) section to learn how to use some basic functions.
- 2. Data Dial:** Use this dial to scroll through the available menu options or adjust the parameter values of the selected field on the screen. Pressing the dial also functions as an **Enter** button.
- 3. Q-Link Knobs:** Use these touch-sensitive knobs to adjust various parameters and settings. The knobs can control one group of parameters at a time. The lights below the Q-Link button indicate the currently selected column of Q-Link knobs. Press the **Q-Link** button to change which parameter or group of parameters they currently control.
- 4. Q-Link Button:** Press this button to change which parameter or group of parameters the **Q-Link knobs** currently control (indicated by the lights above the Q-Link knobs). Each press will select the next column of Q-Link knobs.

Press and hold **Shift** and then press this button to select the previous column of Q-Link knobs instead.

Press and hold this button to show the **Q-Link** window over the touchscreen's current contents. These are the same parameters and settings as what is shown in Q-Link Edit Mode. You can tap **Q-Link Edit** at the bottom of the window to enter Q-Link Edit Mode immediately (see [Operation > Modes > Q-Link Edit Mode](#) to learn about this).

- 5. Pads:** Press these pads to trigger drum hits or other samples in your software. The pads are velocity-sensitive and pressure-sensitive, which makes them very responsive and intuitive to play. The pads will light up different colors, depending on how hard you play them (ranging from yellow at a low velocity to red at the highest velocity). You can also customize their colors.
- 6. Pad Bank:** Press any of these buttons to access Pad Banks A–D.  
Press and hold **Shift** while pressing any of these buttons to access Pad Banks E–H. Alternatively, double-press one of these buttons.
- 7. Note Repeat/Latch:** Press and hold this button, and then press a pad to trigger that pad's sample repeatedly. The rate is based on the current tempo and Time Correct settings.

Press and hold **Shift** and then press this button to "latch" the Note Repeat feature. When latched, you do not have to hold the Note Repeat button for it to be activated. Press **Note Repeat** once more to unlatch it.

8. **Full Level/Half Level:** Press this button to activate or deactivate the Full Level feature. When activated, the pads will always trigger their samples at the maximum velocity (**127**), regardless of how much force you use.  
  
Press and hold **Shift** and then press this button to activate or deactivate the Half Level feature. When activated, the pads will always trigger their samples at half-velocity (**64**).
9. **16 Level / Pad Perform:** Press this button to activate/deactivate 16 Level. When activated, the last pad that was hit will be temporarily copied to all 16 pads. The pads will now output the same note number as the initial pad, but a selectable parameter will be fixed at values that increase as the pad numbers increase (e.g., Pad 1 is the minimum, Pad 16 is the maximum), regardless of how hard you press them. In the screen that appears, use the **Type** selector to choose the parameter: **Velocity**, **Tune**, **Filter**, **Layer**, **Attack** or **Decay**. See [Operation > General Features > 16 Level](#) to learn more.  
  
Press and hold **Shift** and press this button to enter Pad Perform mode for the pads. When activated, you can play musical scales/modes, chords or progressions using the pads while in any mode. See [Operation > Modes > Pad Perform Mode](#) to learn more.
10. **Erase:** As a sequence is playing, press and hold this button and then press a pad to delete the note event for that pad at the current playback position. This is a quick way to delete note events from your sequence without having to stop playback. See [Operation > General Features > Erase](#) to learn more.
11. **Shift:** Press and hold this button to access some buttons' secondary functions (indicated by **gray** writing).  
  
Double-press this button to see which buttons have secondary functions—the buttons will flash for a few seconds.
12. **Menu/Browse:** Press this button to open the Menu. You can tap an option in the Menu to enter that mode, view, etc.  
  
Press and hold **Shift** and then press this button to view the Browser. You can use the Browser to locate and select programs, samples, sequences, etc.
13. **Main/Track:** Press this button to enter Main Mode.  
  
Press and hold **Shift** and then press this button to enter the Track View.
14. **Undo/Redo:** Press this button to undo your last action.  
  
Press and hold **Shift** and press this button to redo the last action you undid.
15. **Copy/Delete:** Press this button to copy one pad to another. When the **From Pad** field is selected, press the “source” pad (the pad you want to copy). When the **To Pad** graphic (of all pads) is selected, press the “destination” pad. You can select multiple destination pads, and you can select pads in different pad banks. Tap **Do It** to continue or **Close** to return to the previous screen.  
  
**Tip: To quickly copy a pad**, press and hold **Copy**, press the source pad, press the destination pad, and then release **Copy**.  
  
Press and hold **Shift** and press this button to delete a pad's sample assignment. When the **Delete Pad** window is shown, press any pad/pads whose sample assignments you want to clear. Tap **Delete** to continue or **Cancel** to return to the previous screen.
16. **-/+:** Press these buttons to increase or decrease the value of the selected field on the screen.
17. **Play:** Press this button to play the sequence from the playhead's current position.
18. **Play Start:** Press this button to play the sequence from its start point.
19. **Stop:** Press this button to stop playback. You can double-press this button to silence audio that is still sounding once a note stops playing. Quickly pressing this button three times will act as a “MIDI panic” and shut off all voices and stop all audio processing.
20. **Rec:** Press this button to record-arm the sequence. Press **Play** or **Play Start** to start recording. Recording in this way (as opposed to using **Overdub**) erases the events of the current sequence. After the sequence plays through once while recording, Overdub will be enabled.
21. **Overdub:** Press this button to enable Overdub. When enabled, you can record events in a sequence without overwriting any previously recorded events. You can enable Overdub before or during recording.
22. **Tap/Master:** Press this button in time with the desired tempo to enter a new tempo (in BPM). You can set how many taps are required in the Preferences (see [Operation > General Features > Menu > Preferences](#) to learn how to do this).  
  
Press and hold **Shift** and press this button to set whether the currently selected sequence follows its own tempo (the button will be lit **red**) or a global tempo (the button will be lit **amber**).

## Rear Panel

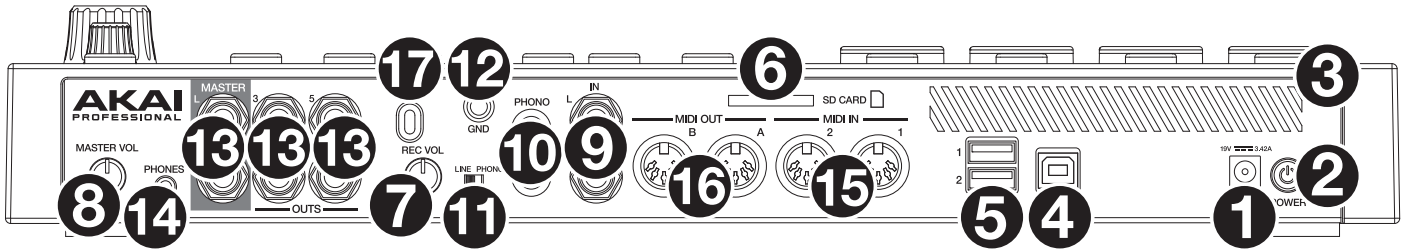

1. **Power Input:** Use the included power adapter to connect MPC Live to a power outlet.
2. **Power Switch:** Turns MPC Live's power on/off.
3. **Charging Indicator:** This light (behind the vent) will turn on when MPC Live's internal battery is charging (when the power input is connected to a power outlet). When the battery is fully charged or when it is disconnected from a power outlet, then this light will turn off.
4. **USB-B Port:** Use the included USB cable to connect this USB 3.0 port to an available USB 3.0 port on your computer. This connection allows MPC Live to send/receive MIDI and audio data to/from the MPC software on your computer. It also allows any connected USB drives, SD cards, and drives connected to the internal SATA port to mount on your computer if MPC Live is in Controller Mode (i.e., your computer can access these storage devices that are connected to your MPC Live).
5. **USB-A Ports:** Connect USB flash drives to these USB ports to access their files directly using MPC Live. MPC Live supports read and write capability for exFAT, FAT32, NTFS, and EXT4 file systems as well as read-only capability for HFS+ file systems. (We recommend using an exFAT file system as it is the most robust one supported by both Windows and macOS.) These USB ports supply power to connected USB devices and can also be used to receive MIDI messages from external USB MIDI devices.
6. **SD Card Slot:** Insert a standard SD/SDHC card into this slot to access its files directly using MPC Live.
7. **Rec Vol:** Turn this knob to adjust the gain of the incoming signal from the 1/4" (6.35 mm) and RCA inputs. Be careful when setting this knob at higher levels, which can cause the signal to distort.
8. **Master Vol:** Turn this knob to adjust the volume of **Output 1/2** and the **phones output**.
9. **Inputs (1/4" / 6.35 mm):** Use standard 1/4" (6.35 mm) TRS cables to connect these inputs to audio sources (microphone, mixer, synthesizer, etc.). To use these inputs, set the **Line/Phono switch** to **Line**. Turn the **Rec Vol** knob to set their input levels.
10. **Inputs (RCA):** Use a standard RCA stereo cable to connect these inputs to a phono-level audio source like a turntable. To use these inputs, set the **Line/Phono switch** to **Phono**. Turn the **Rec Vol** knob to set their input levels.
11. **Line/Phono Switch:** Set this switch to the appropriate position, depending on which inputs you want to use. If you are using the RCA inputs, set this switch to **Phono** to provide the additional amplification needed for phono-level signals. If you are using the 1/4" (6.35 mm) inputs, such as a keyboard or a sampler, set this switch to **Line**.
12. **Grounding Terminal:** If using phono-level turntables with a grounding wire, connect the grounding wire to these terminals. If you experience a low "hum" or "buzz", this could mean that your turntables are not grounded.
 

**Note:** Some turntables have a grounding wire built into the RCA connection and, therefore, nothing needs to be connected to the grounding terminal.
13. **Outputs (1/4" / 6.35 mm):** Use standard 1/4" (6.35 mm) TRS cables to connect these outputs to your speaker system, external mixer, etc. The signal sent out of the **Master L/R** outputs is the main mix. Turn the **Master Vol** knob to set their volume. The signals sent from Outputs 3–6 are full-volume (**0 dB**).
 

**Tip:** To route a program to these outputs, set its routing to **Out 1,2**, **Out 3,4**, or **Out 5,6** (respectively) in the **Channel Mixer** when the **Mixer** field is set to **Programs**. See [Operation > Modes > Channel Mixer](#) to learn more about this.
14. **Phones (1/8" / 3.5 mm):** Connect standard 1/8" (3.5 mm) stereo headphones to this output. Turn the **Master Vol** knob to set the volume level.
15. **MIDI In:** Use standard 5-pin MIDI cables to connect these inputs to the MIDI outputs of optional external MIDI devices.
16. **MIDI Out:** Use standard 5-pin MIDI cables to connect these outputs to the MIDI inputs of optional external MIDI devices.
17. **Kensington® Lock Slot:** You can use this slot to secure your MPC Live to a table or other surface.

## MPC Live II

## Top Panel

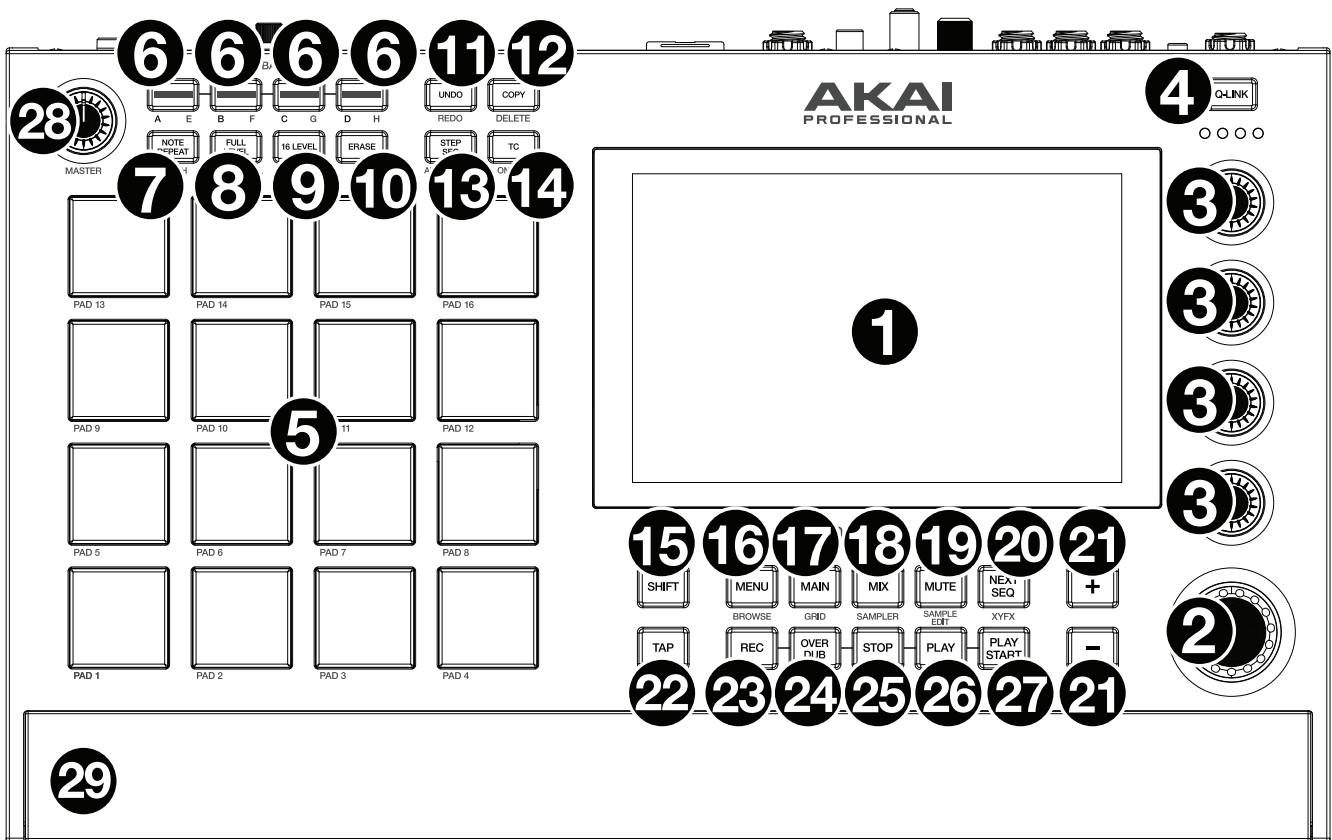

- 1. Touchscreen:** This full-color multi-touch display shows information relevant to MPC Live II's current operation. Touch the display (and use the hardware controls) to control the MPC interface. See the previous [Touchscreens](#) section to learn how to use some basic functions.
- 2. Data Dial:** Use this dial to scroll through the available menu options or adjust the parameter values of the selected field in the **display**. Pressing the dial also functions as an **Enter** button.
- 3. Q-Link Knobs:** Use these touch-sensitive knobs to adjust various parameters and settings. The knobs can control one column of parameters at a time. The lights above the Q-Link Knobs indicate the currently selected column. Press the **Q-Link** button above them to change which column of parameters they currently control.
- 4. Q-Link Button:** Press this button to change which column of parameters the **Q-Link Knobs** currently control (indicated by the lights above the Q-Link Knobs). Each press will select the next column.

Press and hold **Shift** and then press this button to select the previous column instead.

Press and hold this button to show the **Q-Link** window over the touchscreen's current contents. These are the same parameters and settings as what is shown in Q-Link Edit Mode. You can tap **Q-Link Edit** at the bottom of the window to enter Q-Link Edit Mode immediately (see [Operation > Modes > Q-Link Edit Mode](#) to learn about this).

- 5. Pads:** Use these pads to trigger drum hits or other samples. The pads are velocity-sensitive and pressure-sensitive, which makes them very responsive and intuitive to play. The pads will light up different colors, depending on how hard you play them (ranging from yellow at a low velocity to red at the highest velocity). You can also customize their colors.
- 6. Pad Bank Buttons:** Press any of these buttons to access Pad Banks A–D. Press and hold **Shift** while pressing any of these buttons to access Pad Banks E–H. Alternatively, double-press one of these buttons.
- 7. Note Repeat / Latch:** Press and hold this button, and then press a pad to trigger that pad's sample repeatedly. The rate is based on the current tempo and Time Correct settings.

Press and hold **Shift** and then press this button to "latch" the Note Repeat feature. When latched, you do not have to hold the Note Repeat button for it to be activated. Press **Note Repeat** once more to unlatch it.

8. **Full Level / Half Level:** Press this button to activate/deactivate Full Level. When activated, the pads will always trigger their samples at the maximum velocity (**127**), regardless of the amount of force you use.  
Press and hold **Shift** and then press this button to activate/deactivate Half Level. When activated, the pads will always trigger their samples at half-velocity (**64**).
9. **16 Level / Pad Perform:** Press this button to activate/deactivate 16 Level. When activated, the last pad that was hit will be temporarily copied to all 16 pads. The pads will now output the same note number as the initial pad, but a selectable parameter will be fixed at values that increase as the pad numbers increase (e.g., Pad 1 is the minimum, Pad 16 is the maximum), regardless of how hard you press them. In the screen that appears, use the **Type** selector to choose the parameter: **Velocity, Tune, Filter, Layer, Attack** or **Decay**. See [Operation > General Features > 16 Level](#) to learn more.  
Press and hold **Shift** and press this button to activate/deactivate Pad Perform mode for the pads. When activated, you can play musical scales/modes, chords or progressions using the pads while in any mode. Use the [Pad Perform](#) window to configure the settings for the pads.
10. **Erase:** As a Sequence is playing, press and hold this button and then press a pad to delete the note event for that pad at the current playback position. This is a quick way to delete note events from your sequence without having to stop playback. When playback is stopped, press this button to open the Erase window where notes, automation and other sequence data can be erased from the sequence. See [Operation > General Features > Erase](#) to learn more.
11. **Undo / Redo:** Press this button to undo your last action. Hold down **Shift** and press this button to redo the last action you undid.
12. **Copy / Delete:** Press this button to copy one pad to another. When the **From Pad** field is selected, press the “source” pad (the pad you want to copy). When the **To Pad** graphic (of all pads) is selected, press the “destination” pad. You can select multiple destination pads, and you can select pads in different pad banks. Tap **Do It** to continue or **Cancel** to return to the previous screen.  
Press and hold **Shift** and press this button to delete.
13. **Step Seq/Automation:** Press this button to view Step Sequencer Mode where you can create or edit sequences by using the pads as “step buttons,” simulating the experience of a traditional step-sequencer-style drum machine.  
Press and hold **Shift** and press this button to toggle the Global Automation state between **Read** and **Write**.
14. **TC / On/Off:** Press this button to open the Timing Correct window, which contains various settings to help quantize the events in your sequence.  
Press and hold **Shift** and press this button to turn Timing Correct on and off.
15. **Shift:** Press and hold this button to access some buttons’ secondary functions (indicated by gray writing).  
Double-press this button to see which buttons have secondary functions—the buttons will flash for a few seconds.
16. **Menu / Browse:** Press this button to open the Mode Menu. You can tap an option on the Menu screen to enter that mode, view, etc.  
Press and hold **Shift** and then press this button to view the Browser. You can use the Browser to locate and select programs, samples, sequences, etc.
17. **Main / Grid:** Press this button to enter Main Mode.  
Press and hold **Shift** and then press this button to enter Grid View Mode.
18. **Mix / Sampler:** Press this button to view the last used Mixer Mode, either Track Mixer (default) or Pad Mixer. In Track Mixer Mode, you can set levels, stereo panning, and other settings for your tracks, programs, returns, submixes, and main outputs. In Pad Mixer Mode, you can set a program’s levels, stereo panning, routing, and effects. Pressing the button multiple times will toggle between the two Mixer Modes.  
Press and hold **Shift** and then press this button to view the Sampler, where you can record audio samples to use in your projects.
19. **Mute / Sample Edit:** Press this button to view the last used Mute Mode, either Track Mute (default) or Pad Mute. In Track Mute Mode, you can mute tracks within a sequence or set mute groups for each track. In Pad Mute Mode, you can mute pads within a program or set mute groups for each pad within a program. Pressing the button multiple times will toggle between the two Mute Modes.  
Press and hold **Shift** and then press this button to enter Sample Edit Mode where you can edit your samples using various functions and processes.



20. **Next Seq / XYFX:** Press this button to view Next Sequence Mode where you can trigger different sequences simply by playing the pads. This is useful for live performances, letting you change a song's structure in real time.  
  
Press and hold **Shift** and press this button to view XYFX Mode, which turns the touchscreen into an XY pad where each axis represents the range of an effect parameter. As you move touch or move your finger on the touchscreen, the current position will determine the current value of the two parameters. You can use this mode to create interesting effect automation on your tracks.
21. **-/+:** Press these buttons to decrease/increase the value of the selected field in the display.
22. **Tap Tempo / Master:** Press this button in time with the desired tempo to enter a new tempo (in BPM). You can set how many taps are required in the Preferences (see [Operation > General Features > Menu > Preferences](#) to learn how to do this).  
  
Press and hold **Shift** and press this button to set whether the currently selected sequence follows its own tempo (the button will be lit **amber**) or a global tempo (the button will be lit **red**).
23. **Rec:** Press this button to record-arm the sequence. Press **Play** or **Play Start** to start recording. Recording in this way (as opposed to using **Overdub**) erases the events of the current sequence. After the sequence plays through once while recording, Overdub will be enabled.
24. **Overdub:** Press this button to enable Overdub. When enabled, you can record events in a Sequence without overwriting any previously recorded events. You can enable Overdub before or during recording.
25. **Stop:** Press this button to stop playback. You can double-press this button to silence audio that is still sounding once a note stops playing. Press and hold **Shift** and press this button to stop playback and return the playhead to 1:1:0.
26. **Play:** Press this button to play the sequence from the playhead's current position.
27. **Play Start:** Press this button to play the sequence from its start point.
28. **Master Vol:** Turn this knob to adjust the volume of the **Master L/R outputs, phones output and speakers**.
29. **Speakers:** When the **Speaker** switch on the rear panel is set to **On**, these speakers will play the current audio. Use the **Master Volume** knob to control the volume of the speakers.

## Rear Panel

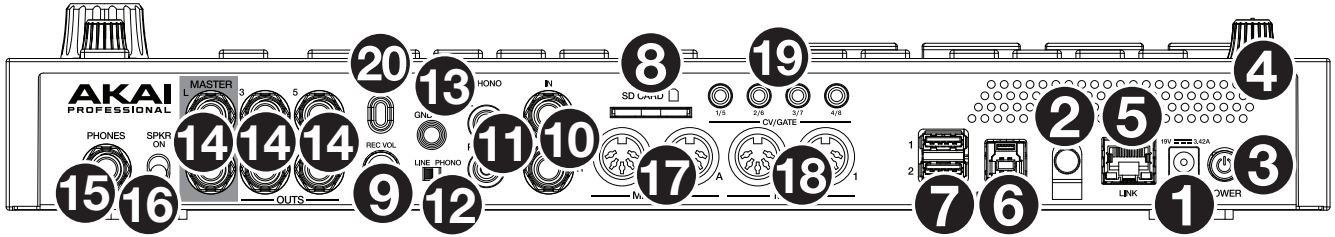

1. **Power Input:** Use the included power adapter to connect MPC Live II to a power outlet.
2. **Power Adapter Restraint:** Secure the power adapter cable to this restraint to prevent it from accidentally unplugging.
3. **Power Switch:** Turns MPC Live II's power on/off.
4. **Charging Indicator:** This light (behind the vent) will turn on when MPC Live II's internal battery is charging (when the power input is connected to a power outlet). When the battery is fully charged or when it is disconnected from a power outlet, then this light will turn off.
5. **Link:** Connect a standard Ethernet cable to this port to use Ableton Link and other compatible devices with MPC Live II. See [Operation > General Features > Menu > Sync](#) for more information.  
**Note:** You can also use Ableton Link wirelessly over a Wi-Fi connection.
6. **USB-B Port:** Use the included USB cable to connect this high-retention-force USB port to an available USB port on your computer. This connection allows MPC Live II to send/receive MIDI and audio data to/from the MPC software on your computer.
7. **USB-A Ports:** Connect USB flash drives to these USB ports to access their files directly using MPC Live II. When connected to a computer in Controller Mode, you can access drives connected to this port from your computer. You can also connect standard MIDI controllers to these ports.
8. **SD Card Slot:** Insert a standard SD, SDHC or SDXC card into this slot to access its files directly using MPC Live II.
9. **Rec Vol:** Turn this knob to adjust the volume of the **inputs**.
10. **Inputs (1/4" / 6.35 mm):** Use standard 1/4" (6.35 mm) TRS cables to connect these inputs to an audio source (mixer, synthesizer, drum machine, etc.). In Sample Record Mode, you can select whether you want to record either channel or both channels in stereo or in mono. To use these inputs, set the **Line/Phono switch** to **Line**.
11. **Inputs (RCA):** Use a standard RCA stereo cable to connect these inputs to a phono-level audio source like a turntable. In Sample Record Mode, you can select whether you want to record either channel or both channels in stereo or in mono. To use these inputs, set the **Line/Phono switch** to **Phono**.
12. **Line/Phono Switch:** Set this switch to the appropriate position, depending on which inputs you want to use. If you are using the RCA inputs, set this switch to **Phono** to provide the additional amplification needed for phono-level signals. If you are using the 1/4" (6.35 mm) inputs, such as a CD player or sampler, set this switch to **Line**.
13. **Grounding Terminal:** If using phono-level turntables with a grounding wire, connect the grounding wire to these terminals. If you experience a low "hum" or "buzz", this could mean that your turntables are not grounded.  
**Note:** Some turntables have a grounding wire built into the RCA connection and, therefore, nothing needs to be connected to the grounding terminal.
14. **Outputs (1/4" / 6.35 mm):** Use standard 1/4" (6.35 mm) TRS cables to connect these outputs to your monitors, mixer, etc.). The **Master L/R** outputs are the same as **Outputs 1,2**.
15. **Phones (1/4" / 6.35 mm):** Connect standard 1/4" (6.35 mm) stereo headphones to this output.
16. **Speaker On/Off:** Use this switch to turn the MPC Live II internal speakers on or off.
17. **MIDI In:** Use a standard 5-pin MIDI cable to connect these inputs to the MIDI output of an external MIDI device (synthesizer, drum machine, etc.).
18. **MIDI Out:** Use a standard 5-pin MIDI cable to connect these outputs to the MIDI input of an external MIDI device (synthesizer, drum machine, etc.).
19. **CV/Gate Out:** MPC Live II will send control voltage (CV) and/or Gate signals over these outputs to optional external sequencers. Use standard 1/8" (3.5 mm) TS cables to send a single CV/Gate signal per output, or use a stereo TRS-to-dual mono TSF breakout cable (such as a Hosa YMM-261) to send two CV/Gate signals per output.
20. **Kensington® Lock Slot:** You can use this slot to secure your MPC Live II to a table or other surface.

MPC One / MPC One+

**Note:** Mentions of the features and functions of MPC One hardware throughout this guide also apply to the MPC One+ unless otherwise noted.

Top Panel

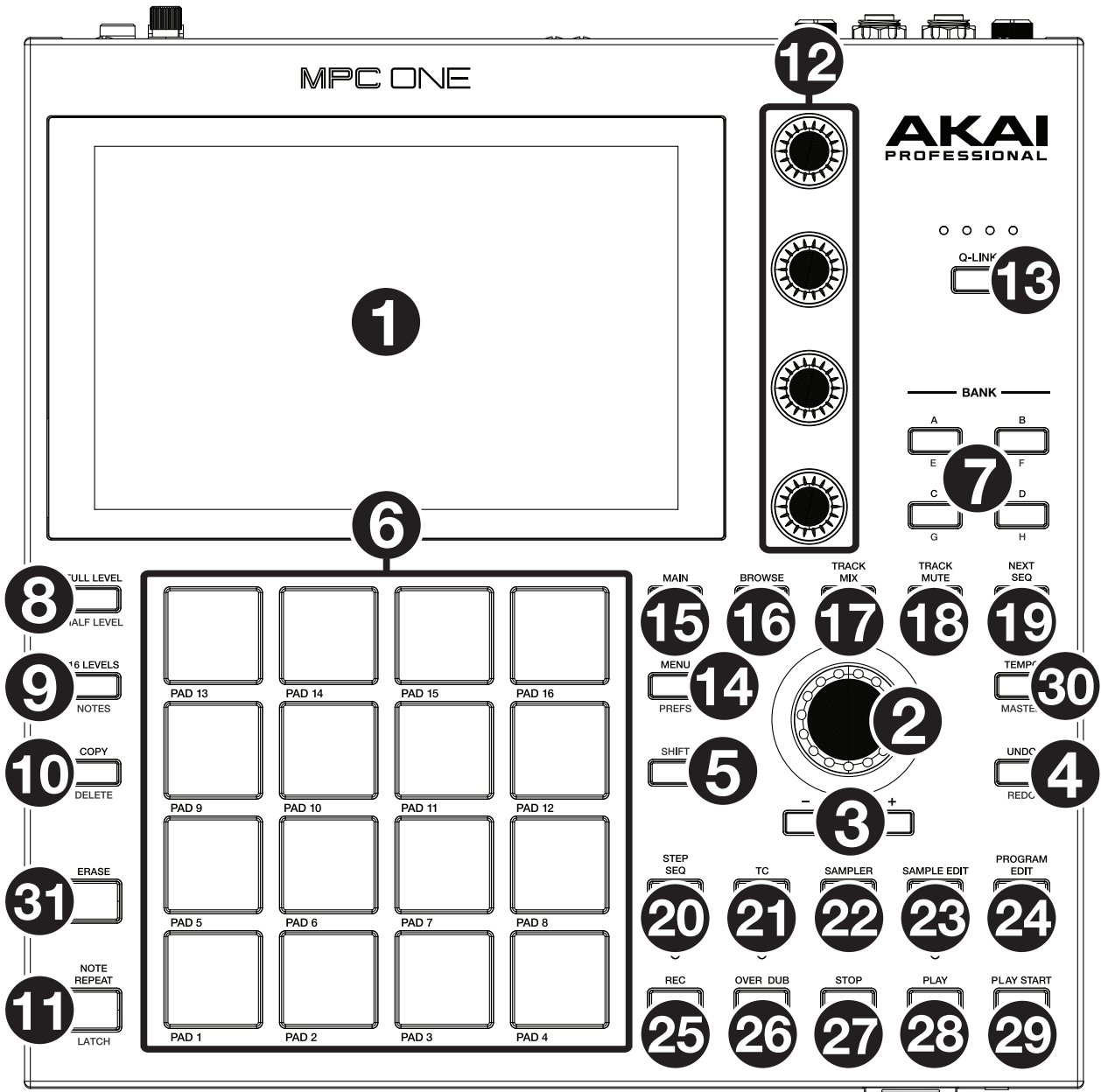

Navigation & Data Entry Controls

1. **Touchscreen:** This full-color multi-touch display shows information relevant to MPC One’s current operation. Touch the display (and use the hardware controls) to control the MPC interface. See the previous [Touchscreens](#) section to learn how to use some basic functions.
2. **Data Dial:** Use this dial to scroll through the available menu options or adjust the parameter values of the selected field in the **display**. Pressing the dial also functions as an **Enter** button.
3. **-/+:** Press these buttons to increase or decrease the value of the selected field in the display.
4. **Undo / Redo:** Press this button to undo your last action.  
Press and hold **Shift** and press this button to redo the last action you undid.
5. **Shift:** Press and hold this button to access some buttons’ secondary functions (indicated by **red** writing).

## Pad & Q-Link Controls

6. **Pads:** Use these pads to trigger drum hits or other samples. The pads are velocity-sensitive and pressure-sensitive, which makes them very responsive and intuitive to play. The pads will light up different colors, depending on how hard you play them (ranging from yellow at a low velocity to red at the highest velocity). You can also customize their colors.
7. **Pad Bank Buttons:** Press any of these buttons to access Pad Banks A–D. Press and hold **Shift** while pressing any of these buttons to access Pad Banks E–H. Alternatively, double-press one of these buttons.
8. **Full Level / Half Level:** Press this button to activate/deactivate Full Level. When activated, the pads will always trigger their samples at the maximum velocity (**127**), regardless of the amount of force you use.  
Press and hold **Shift** and then press this button to activate/deactivate Half Level. When activated, the pads will always trigger their samples at half-velocity (**64**).
9. **16 Level / Pad Perform (Notes):** Press this button to activate/deactivate 16 Level. When activated, the last pad that was hit will be temporarily copied to all 16 pads. The pads will now output the same note number as the initial pad, but a selectable parameter will be fixed at values that increase as the pad numbers increase (e.g., Pad 1 is the minimum, Pad 16 is the maximum), regardless of how hard you press them. In the screen that appears, use the **Type** selector to choose the parameter: **Velocity, Tune, Filter, Layer, Attack** or **Decay**. See [Operation > General Features > 16 Level](#) to learn more.  
Press and hold **Shift** and press this button to enter Pad Perform (Notes) mode for the pads. When activated, you can play musical scales/modes, chords or progressions using the pads while in any mode. See [Operation > Modes > Pad Perform Mode](#) to learn more.
10. **Copy / Delete:** Press this button to copy one pad to another. When the **From Pad** field is selected, press the “source” pad (the pad you want to copy). When the **To Pad** graphic (of all pads) is selected, press the “destination” pad. You can select multiple destination pads, and you can select pads in different pad banks. Tap **Do It** to continue or **Cancel** to return to the previous screen.  
Press and hold **Shift** and press this button to delete.
11. **Note Repeat / Latch:** Press and hold this button, and then press a pad to trigger that pad’s sample repeatedly. The rate is based on the current tempo and Time Correct settings.  
Press and hold **Shift** and then press this button to “latch” the Note Repeat feature. When latched, you do not have to hold the Note Repeat button for it to be activated. Press **Note Repeat** once more to unlatch it.
12. **Q-Link Knobs:** Use these touch-sensitive knobs to adjust various parameters and settings. The knobs can control one column of parameters at a time. The lights above the Q-Link Knobs indicate the currently selected column. Press the **Q-Link** button to change which column of parameters they currently control.
13. **Q-Link Button:** Press this button to change which column of parameters the **Q-Link Knobs** currently control (indicated by the lights above the Q-Link Knobs). Each press will select the next column.  
Press and hold **Shift** and then press this button to select the previous column instead.

## Mode & View Controls

14. **Menu / Prefs:** Press this button to open the Mode Menu. You can tap an option on the Menu screen to enter that mode, view, etc.  
Press and hold **Shift** and then press this button to open the Preferences page in the Menu.
15. **Main / Grid:** Press this button to enter Main Mode.  
Press and hold **Shift** and then press this button to enter Grid View Mode.
16. **Browse / Save:** Press this button to view the Browser. You can use the Browser to locate and select programs, samples, sequences, etc.  
Press and hold **Shift** and then press this button to save the current project (including its samples, programs, sequences, and songs).
17. **Track Mix / Pad Mix:** Press this button to view the Track Mixer where you can set levels, stereo panning, and other settings for your tracks, programs, returns, submixes, and main outputs.  
Press and hold **Shift** and then press this button to view the Pad Mixer where you can set a program’s levels, stereo panning, routing, and effects.

18. **Track Mute / Pad Mute:** Press this button to view Track Mute Mode where you can easily mute tracks within a sequence or set mute groups for each track.  
  
Press and hold **Shift** and press this button to view Pad Mute Mode where you can easily mute pads within a program or set mute groups for each pad within a program.
19. **Next Seq / XYFX:** Press this button to view Next Sequence Mode where you can trigger different sequences simply by playing the pads. This is useful for live performances, letting you change a song's structure in real time.  
  
Press and hold **Shift** and press this button to view XYFX Mode, which turns the touchscreen into an XY pad where each axis represents the range of an effect parameter. As you move touch or move your finger on the touchscreen, the current position will determine the current value of the two parameters. You can use this mode to create interesting effect automation on your tracks.
20. **Step Seq / Automation:** Press this button to view Step Sequencer Mode where you can create or edit sequences by using the pads as "step buttons," simulating the experience of a traditional step-sequencer-style drum machine.  
  
Press and hold **Shift** and press this button to toggle Global Automation between **Read** and **Write**.
21. **TC / On/Off:** Press this button to open the Timing Correct window, which contains various settings to help quantize the events in your sequence.  
  
Press and hold **Shift** and press this button to turn Timing Correct on and off.
22. **Sampler / Looper:** Press this button to view the Sampler where you can record audio samples to use in your projects.  
  
Press and hold **Shift** and press this button to view the Looper where you can record and overdub audio in real time—a great tool for live performance as well as spontaneous moments in the studio. You can export the loop as a sample to use in your project.
23. **Sample Edit / Q-Link Edit:** Press this button to view Sample Edit Mode where you can edit your samples using various functions and processes.  
  
Press and hold **Shift** and press this button to view Q-Link Edit Mode where you can assign other parameters to the Q-Link knobs.
24. **Program Edit / MIDI Control:** Press this button to view Program Edit Mode, which contains all parameters for editing your programs.  
  
Press and hold **Shift** and press this button to view MIDI Control Mode where you can customize what MIDI messages are sent from certain controls on your hardware.

## Transport & Recording Controls

25. **Rec:** Press this button to record-arm the sequence. Press **Play** or **Play Start** to start recording. Recording in this way (as opposed to using **Overdub**) erases the events of the current sequence. After the sequence plays through once while recording, Overdub will be enabled.
26. **Overdub:** Press this button to enable Overdub. When enabled, you can record events in a Sequence without overwriting any previously recorded events. You can enable Overdub before or during recording.
27. **Stop:** Press this button to stop playback. You can double-press this button to silence audio that is still sounding once a note stops playing. Press and hold **Shift** and press this button to return the playhead to 1:1:0.
28. **Play:** Press this button to play the sequence from the playhead's current position.
29. **Play Start:** Press this button to play the sequence from its start point.
30. **Tap Tempo / Master (Global):** Press this button in time with the desired tempo to enter a new tempo (in BPM).  
  
Press and hold **Shift** and press this button to set whether the currently selected sequence follows its own tempo (the button will be lit **amber**) or a global tempo (the button will be lit **red**).
31. **Erase:** As a Sequence is playing, press and hold this button and then press a pad to delete the note event for that pad at the current playback position. This is a quick way to delete note events from your sequence without having to stop playback. When playback is stopped, press this button to open the Erase window where notes, automation and other sequence data can be erased from the sequence.

## Front Panel

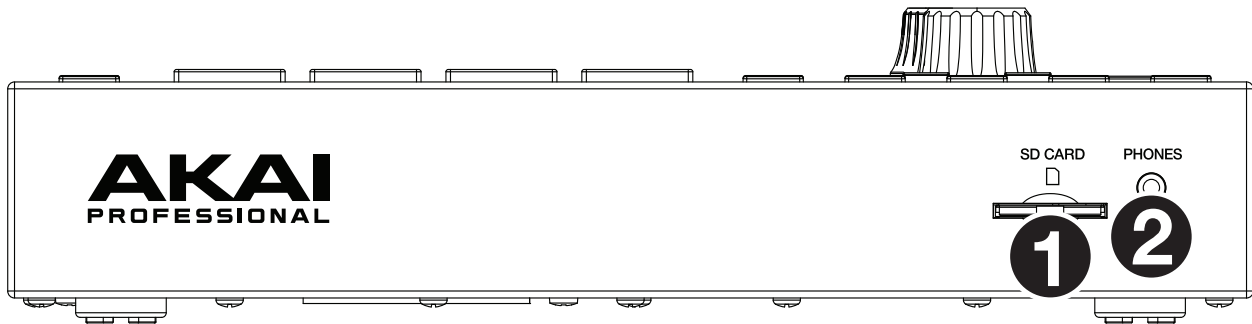

1. **SD Card Slot:** Insert a standard SD, SDHC or SDXC card into this slot to access its files directly using MPC One.
2. **Phones (1/8" / 3.5 mm):** Connect standard 1/8" (3.5 mm) stereo headphones to this output.

## Rear Panel

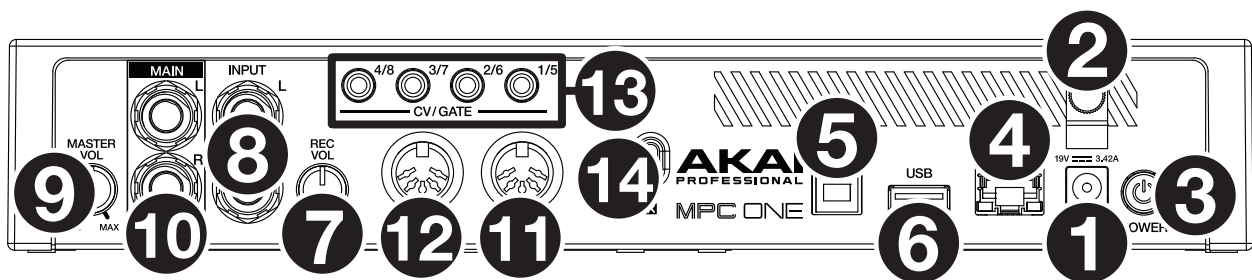

1. **Power Input:** Use the included power adapter to connect MPC One to a power outlet.
2. **Power Adapter Restraint:** Secure the power adapter cable to this restraint to prevent it from accidentally unplugging.
3. **Power Switch:** Turns MPC One's power on/off.
4. **Link:** Connect a standard Ethernet cable to this port to use Ableton Link and other compatible devices with MPC One. See [Operation > General Features > Menu > Sync](#) for more information.

**Note:** You can also use Ableton Link wirelessly over a Wi-Fi connection.

**Note:** The Link port is not included on MPC One+.

5. **USB-B Port:** Use the included USB cable to connect this high-retention-MPC One USB port to an available USB port on your computer. This connection allows MPC One to send/receive MIDI and audio data to/from the MPC software on your computer.
6. **USB-A Port:** Connect a USB flash drive to this USB port to access files directly using MPC One. You can also connect a standard MIDI controller to this port.
7. **Rec Vol:** Turn this knob to adjust the volume of the **inputs**.
8. **Inputs (1/4" / 6.35 mm):** Use standard 1/4" (6.35 mm) TRS cables to connect these inputs to an audio source (mixer, synthesizer, drum machine, etc.). In Sample Record Mode, you can select whether you want to record either channel or both channels in stereo or in mono.
9. **Master Vol:** Turn this knob to adjust the volume of the **outputs** and **phones output**.
10. **Outputs (1/4" / 6.35 mm):** Use standard 1/4" (6.35 mm) TRS cables to connect these outputs to your monitors, mixer, etc.
11. **MIDI In:** Use a standard 5-pin MIDI cable to connect this input to the MIDI output of an external MIDI device (synthesizer, drum machine, etc.).
12. **MIDI Out:** Use a standard 5-pin MIDI cable to connect this output to the MIDI input of an external MIDI device (synthesizer, drum machine, etc.).
13. **CV/Gate Outs:** MPC One will send control voltage (CV) and/or Gate signals over these outputs to optional external sequencers. Use standard 1/8" (3.5 mm) TS cables to send a single CV/Gate signal per output, or use a stereo TRS-to-dual mono TSF breakout cable (such as a Hosa YMM-261) to send two CV/Gate signals per output.
14. **Kensington® Lock Slot:** You can use this slot to secure your MPC One to a table or other surface.

## MPC Key 61

## Top Panel

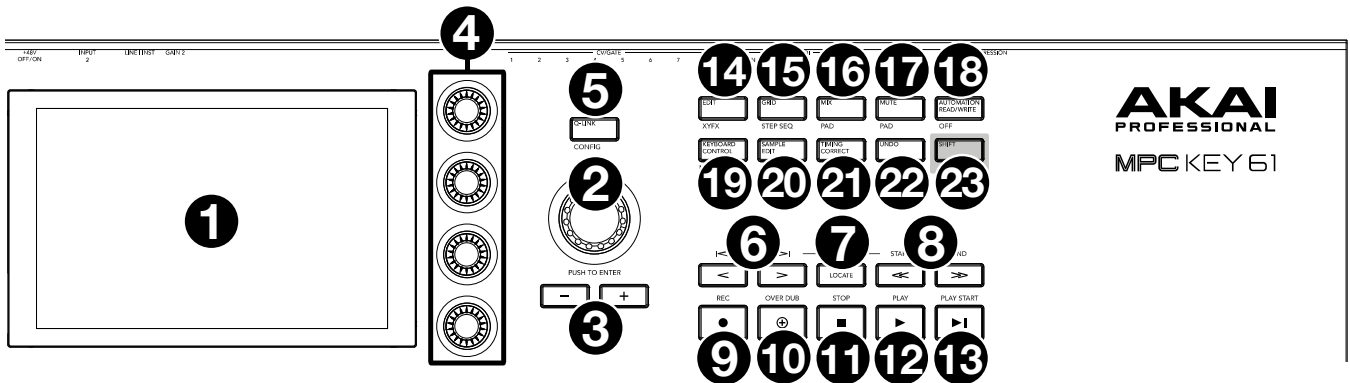

1. **Display:** This full-color multi-touch display shows information relevant to MPC Key 61's current operation. Touch the display (and use the hardware controls) to control the MPC interface. See the previous [Touchscreens](#) section to learn how to use some basic functions.
2. **Data Dial:** Use this dial to scroll through the available menu options or adjust the parameter values of the selected field on the **display**. Pressing the dial also functions as an **Enter** button.
3. **-/+:** Press these buttons to increase or decrease the value of the selected field on the display.
4. **Q-Link Knobs:** Use these touch-sensitive knobs to adjust various parameters and settings. The knobs can control one column of parameters at a time. The lights above the **Q-Link button** indicate the currently selected column. Press the **Q-Link** button to change which column of parameters they currently control.
5. **Q-Link Button:** Press this button to change which column of parameters the **Q-Link Knobs** currently control (indicated by the lights above the button). Each press will select the next column.  
Press and hold **Shift** and then press this button to view the Q-Link Configuration window. Press and hold **Shift** and then press this button again to return to the Main page.
6. **</> (Event |</>):** Use these buttons to move the playhead left/right, one step at a time.  
Press and hold **Locate** and press one of these buttons to move the playhead to the previous/next event in the sequence grid.
7. **Locate:** Press this button to open the Locate window, which allows you to quickly jump to specific points in your project.  
Press and hold this button to activate the secondary functions of the </> and <</>> buttons (i.e., **Event |</>** and **Start/End**, respectively).
8. **<</>> (Start/End):** Use these buttons to move the playhead left/right, one bar at a time.  
Press and hold **Locate** and press one of these buttons to move the playhead to the start or end of the sequence grid.
9. **Rec / Recall:** Press this button to record-arm the sequence. Press **Play** or **Play Start** to start recording. Recording in this way (rather than using **Overdub**) erases the events of the current sequence. After the sequence plays through once while recording, Overdub will be enabled.  
Press and hold **Shift** and press this button to recall recently played MIDI note events when recording was disabled and insert them into the current sequence.
10. **Overdub:** Press this button to enable Overdub, which allows you to record note events in a sequence without overwriting any previously recorded note events. You can enable Overdub either before or during recording.
11. **Stop / Return:** Press this button to stop playback. Double-press this button to immediately stop all sound.  
Press and hold **Shift** and press this button to stop playback and return the playhead to the Loop Start value.
12. **Play:** Press this button to play the sequence from the playhead's current position.
13. **Play Start:** Press this button to play the sequence from its start point.
14. **Edit / XYFX:** Press this button to view Program Edit Mode, which contains all parameters for editing your programs.  
Press and hold **Shift** and press this button to view XYFX Mode, which turns the touchscreen into an XY pad where each axis represents the range of an effect parameter. As you touch or move your finger on the touchscreen, the current position will determine the current value of the two parameters. You can use this mode to create interesting effect automation on your tracks.

15. **Grid / Step Seq:** Press this button to enter Grid View Mode, where you can view and edit the note events of each track of a sequence in a project and their velocities.  
  
Press and hold **Shift** and press this button to view Step Sequencer Mode where you can create or edit sequences by using the pads as "step buttons," simulating the experience of a traditional step-sequencer-style drum machine.
16. **Mix / Pad:** Press this button to view the Track Mixer where you can set levels, stereo panning, and other settings for your tracks, programs, returns, submixes, and main outputs.  
  
Press and hold **Shift** and then press this button to view the Pad Mixer where you can set a program's levels, stereo panning, routing, and effects.
17. **Mute / Pad:** Press this button to view Track Mute Mode where you can easily mute tracks within a sequence or set mute groups for each track.  
  
Press and hold **Shift** and press this button to view Pad Mute Mode where you can easily mute pads within a program or set mute groups for each pad within a program.
18. **Automation Read/Write / Off:** Press this button to toggle the Global Automation state between **Read** and **Write**.  
  
Press and hold **Shift** and press this button to disable or enable Global Automation.
19. **Keyboard Control / MIDI CTRL:** Press this button to view the Keyboard Control menu, where you can customize the functions of the keyboard and wheels, including velocity response, routing, MIDI assignments, ranges and more.  
  
Press and hold **Shift** and press this button to view MIDI Control Mode, where you can use the device as a MIDI controller and customize what MIDI messages are sent from the hardware controls.
20. **Sample Edit / Sampler:** Press this button to view Sample Edit Mode where you can edit your samples using various functions and processes.  
  
Press and hold **Shift** and press this button to view the Sampler where you can record audio samples to use in your projects.
21. **Timing Correct / On/Off:** Press this button to open the Timing Correct window, which contains various settings to help quantize the events in your sequence.  
  
Press and hold **Shift** and press this button to turn Timing Correct on and off.
22. **Undo / Redo:** Press this button to undo your last action.  
  
Press and hold **Shift** and press this button to redo the last action you undid.
23. **Shift:** Press and hold this button to access some buttons' secondary functions (indicated by white writing).



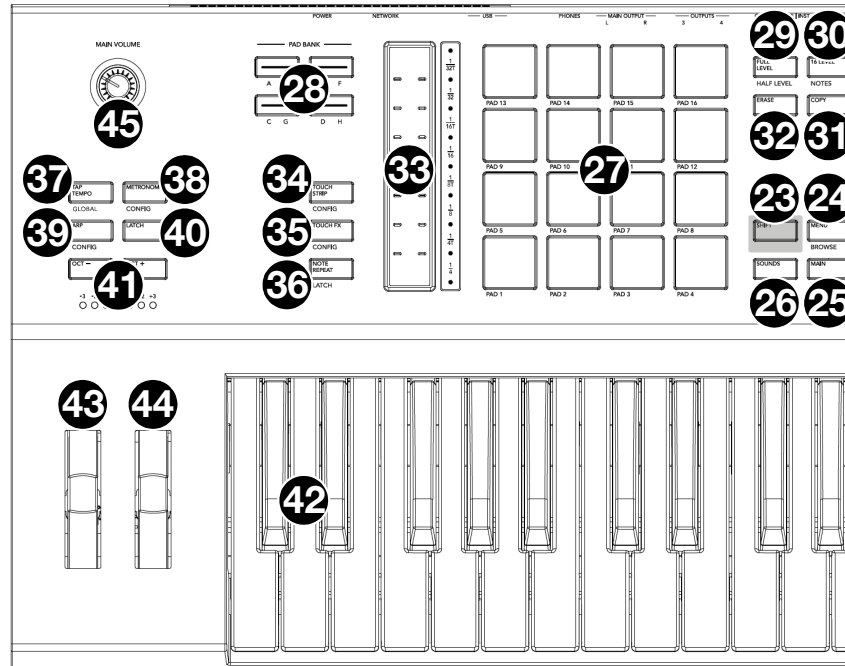

24. **Menu / Browse:** Press this button to open the Mode Menu. You can tap an option on the Menu screen to enter that mode, view, etc.

Press and hold **Shift** and then press this button to view the Browser. You can use the Browser to locate and select programs, samples, sequences, etc.

25. **Main / Track:** Press this button to view Main Mode.

Press and hold **Shift** and press this button to view Track View Mode, an overview of the tracks of each sequence. You can also set key ranges in this mode.

26. **Sounds / Favorites:** Press this button to view Sounds Mode, where you can browse MPC Key 61's built-in instruments and presets.

Press and hold **Shift** and press this button to view Favorites, where you can quickly select instruments and presets that you have defined as your favorites.

27. **Pads:** Use these pads to trigger drum hits or other samples. The pads are velocity-sensitive and pressure-sensitive, which makes them very responsive and intuitive to play. The pads will light up different colors, depending on the current function. You can also customize their colors.

28. **Pad Bank Buttons:** Press any of these buttons to access Pad Banks A–D. Press and hold **Shift** while pressing any of these buttons to access Pad Banks E–H. Alternatively, double-press one of these buttons.

29. **Full Level / Half Level:** Press this button to activate/deactivate Full Level. When activated, the pads will always trigger their samples at the maximum velocity (**127**), regardless of the amount of force you use.

Press and hold **Shift** and press this button to activate/deactivate Half Level. When activated, the pads will always trigger their samples at half-velocity (**64**).

30. **16 Level / Notes:** Press this button to activate/deactivate 16 Level. When activated, the last pad that was hit will be temporarily copied to all 16 pads. The pads will play the same sample as the original pad, but a selectable parameter will increase in value with each pad number, regardless of the amount of force you use. In the screen that appears, use the **Type** selector to choose another parameter: **Velocity**, **Tune**, **Filter**, **Layer**, **Attack** or **Decay**. See [Operation > General Features > 16 Level](#) to learn more.

Press and hold **Shift** and press this button to activate/deactivate Notes mode for the pads. When activated, you can play musical scales/modes, chords or progressions using the pads while in any mode. Use the Pad Perform window to configure the settings for the pads. See [Operation > Modes > Pad Perform Mode](#) to learn more.

31. **Erase:** As a Sequence is playing, press and hold this button and then press a pad or key to delete the note event for that pad or key at the current playback position. This is a quick way to delete note events from your sequence without having to stop playback. When playback is stopped, press this button to open the Erase window where notes, automation and other sequence data can be erased from the sequence.

32. **Copy / Delete:** Press this button to copy one pad to another in Clip and Drum programs. When the **From Pad** field is selected, press the “source” pad (the pad you want to copy). When the **To Pad** graphic (of all pads) is selected, press the “destination” pad. You can select multiple destination pads, and you can select pads in different pad banks. Tap **Do It** to continue or **Cancel** to return to the previous screen.
- Press and hold **Shift** and press this button to delete.
33. **Touch Strip:** The touch strip can be used as an expressive control for playing and can be configured to control Note Repeat, Pitch Bend, Modulation and more.
34. **Touch Strip / Config:** Press this button to cycle between control modes for the Touch Strip. Press and hold the button to quickly select one of the control modes.
- Press and hold **Shift** and press this button to view the Touch Strip Configuration window.
35. **Touch FX / Config:** Press this button to enable Touch FX control for the Touch Strip. This allows you to control parameters from the Touch FX plugin using the Touch Strip. Press and hold this button to quickly select a Touch FX preset.
- Press and hold **Shift** and press this button to view the Touch FX Configuration window.
36. **Note Repeat / Latch:** Press and hold this button, and then press a pad to trigger that pad’s sample repeatedly. The rate is based on the current tempo and Timing Correct settings.
- Press and hold **Shift** and press this button to “latch” the Note Repeat feature. When latched, you do not have to hold the Note Repeat button for it to be activated. Press **Note Repeat** once more to unlatch it.
37. **Tap Tempo / Global:** Press this button in time with the desired tempo to enter a new tempo (in BPM). Press and hold this button to adjust the tempo manually using the **data dial**.
- Press and hold **Shift** and press this button to set whether the currently selected sequence follows its own tempo (the button will be lit **white**) or a global tempo (the button will be lit **red**).
38. **Metronome / Config:** Press this button to enable or disable the metronome.
- Press and hold **Shift** and press this button, or press and hold this button, to open the Metronome Configuration window.
39. **Arp / Config:** Press this button to enable or disable the internal Arpeggiator, whose rate is based on the current Tempo and Time Division settings.
- Press and hold **Shift** and press this button, or press and hold this button, to configure the Arpeggiator’s settings.
40. **Latch:** Press this button to enable or disable latch for the Arpeggiator. When latched, you do not have to hold the keys for the arpeggiation to continue.
- Play a chord on the keyboard and then press and hold **Shift** and press this button to enable Chord Mode. Playing any note will now play the full chord transposed to the new note with a single key press.
41. **Oct - / Oct +:** Press these buttons to transpose the keyboard down or up one octave at a time. The lights below this button will indicate the current octave setting.
- Press and hold **Shift** and press these buttons to transpose the keyboard down or up one semitone at a time.
- Press and hold both buttons and press a key on the keyboard to set the transposition to that value.
- Press and hold both buttons and release to reset the transposition.
42. **Keybed:** Use this 61-key semi-weighted, velocity-sensitive keybed to input notes and aftertouch.
43. **Pitch Wheel:** The pitch bend wheel is primarily used to bend the notes played on the keyboard up or down. This allows you to play phrases not normally associated with keyboard playing, such as guitar-style riffs.
44. **Modulation Wheel:** The modulation wheel is typically used to add variation for the sound you are playing. This type of real-time controller was originally introduced on electronic keyboard instruments to give the performer options such as adding vibrato, just like the players of acoustic instruments do.
45. **Main Volume:** Turn this knob to adjust the volume of the **outputs** and **phones output**.

## Rear Panel

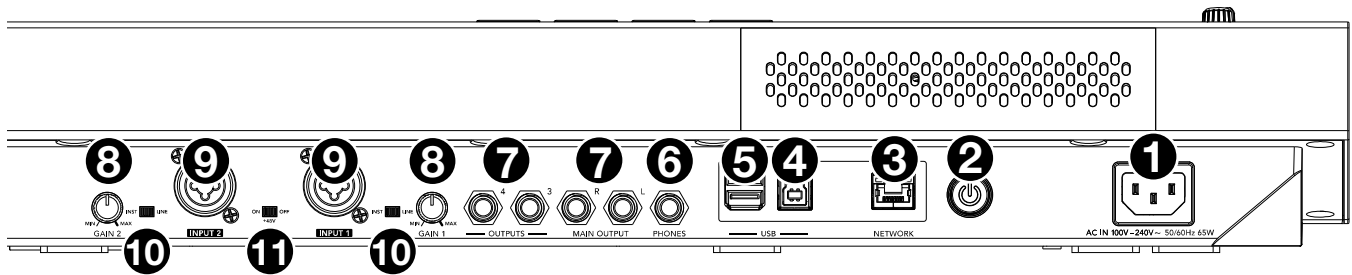

1. **Power Input:** Use the included power adapter to connect MPC Key 61 to a power outlet.
2. **Power Switch:** Turns MPC Key 61's power on/off.
3. **Network:** Connect a standard Ethernet cable to this port to use Ableton Link and other compatible devices with MPC Key 61. See [Operation > General Features > Menu > Sync](#) for more information.

**Note:** You can also use Ableton Link wirelessly over a Wi-Fi connection.

4. **USB-B Port:** Use the included USB cable to connect this high-retention-force USB port to an available USB port on your computer. This connection allows MPC Key 61 to send/receive MIDI and audio data to/from the MPC software on your computer.
5. **USB-A Ports:** Connect a USB flash drive to these USB ports to access its files directly using MPC Key 61. You can also connect any class-compliant MIDI device to these ports.
6. **Phones (1/4" / 6.35 mm):** Connect standard stereo headphones to this output.
7. **Outputs (1/4" / 6.35 mm):** Use standard TRS cables to connect these outputs to your monitors, mixer, etc.). The **Main L/R** outputs are the same as **Outputs 1,2**.
8. **Gain:** Use these knobs to adjust the gain of the incoming signal from **Input 1/2** on the rear panel. Be careful when setting this knob at higher levels, as this can cause the signal to distort.
9. **Inputs 1/2 (XLR or 1/4" / 6.35 mm):** Use standard XLR or TRS cables to connect these inputs to audio sources (microphone, mixer, synthesizer, etc.). When using a 1/4" cable, the Mic preamp is removed from the circuit, and the **Line/Inst** switch can be used to set the impedance.

Turn the **Gain** knobs to set the input level of each one.

10. **Line/Inst:** Use these switches to set **Inputs 1/2** to accept either a Line-level or Instrument-level sound source when using a 1/4" connection.
11. **Phantom Power (+48V):** This switch activates and deactivates phantom power for **Inputs 1/2** when using an XLR connection. When activated, +48V of phantom power will be supplied to both inputs. Note that most dynamic microphones do **not** require phantom power, while most condenser microphones **do**. Refer to your microphone's documentation to check if it needs phantom power.

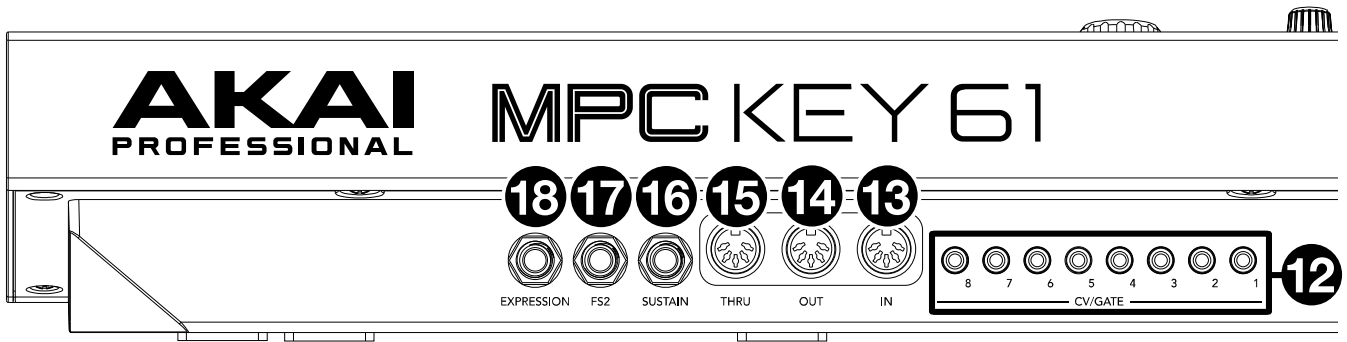

12. **CV/Gate Out** (1/8" / 3.5 mm, TS): MPC Key 61 will send control voltage (CV) and/or Gate signals over these outputs to optional external synths or sequencers. Use standard 1/8" (3.5 mm) TS cables to send a single CV/Gate signal per output.
13. **MIDI In**: Use a standard 5-pin MIDI cable to connect these inputs to the MIDI output of an external MIDI device (additional MIDI keyboard, pad controller, etc.).
14. **MIDI Out**: Use a standard 5-pin MIDI cable to connect these outputs to the MIDI input of an external MIDI device (synthesizer, drum machine, etc.).
15. **MIDI Thru**: Use a standard 5-pin MIDI cable to connect this thru-port to the MIDI input of an external MIDI device (synthesizer, drum machine, etc.). MIDI from the **MIDI In** will be sent through this output.
16. **Sustain** (1/4" / 6.35 mm, TRS): This input accepts an optional momentary-contact foot pedal. When pressed, the pedal will sustain the sound you are playing without having to keep your fingers pressed down on the keys.
17. **FS2** (1/4" / 6.35 mm, TRS): Connect an optional 1/4" (6.35 mm) TRS footswitch or other foot pedal to this input.
18. **Expression** (1/4" / 6.35 mm, TRS): Connect an optional expression pedal to this input for adding expressive changes during performances.

## MPC Key 37

## Top Panel

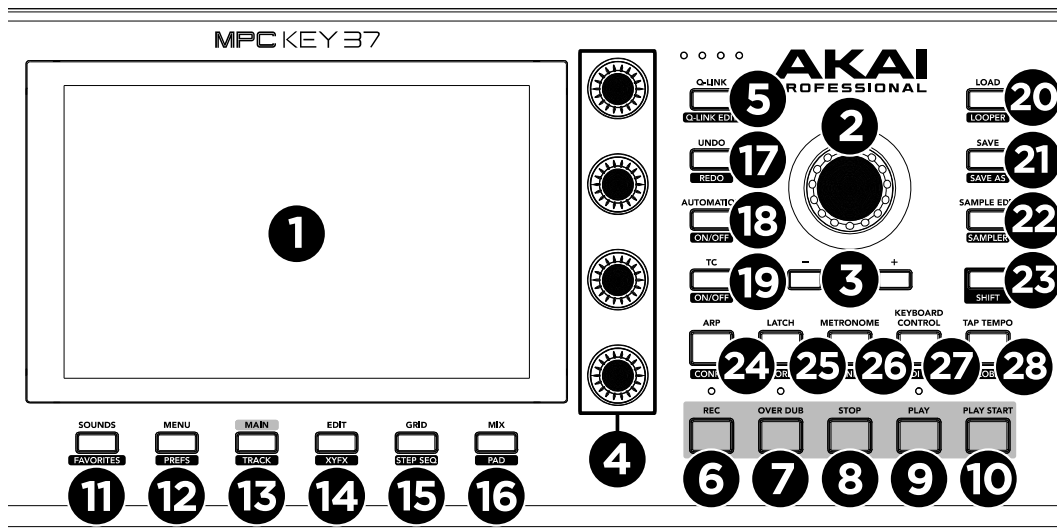

1. **Display:** This full-color multi-touch display shows information relevant to MPC Key 37's current operation. Touch the display (and use the hardware controls) to control the MPC interface. See the previous [Touchscreens](#) section to learn how to use some basic functions.
2. **Data Dial:** Use this dial to scroll through the available menu options or adjust the parameter values of the selected field on the **display**. Pressing the dial also functions as an **Enter** button.
3. **-/+:** Press these buttons to increase or decrease the value of the selected field on the display.
4. **Q-Link Knobs:** Use these touch-sensitive knobs to adjust various parameters and settings. The knobs can control one column of parameters at a time. The lights above the **Q-Link** button indicate the currently selected column. Press the **Q-Link** button to change which column of parameters they currently control.
5. **Q-Link Button:** Press this button to change which column of parameters the **Q-Link Knobs** currently control (indicated by the lights above the button). Each press will select the next column.  
Press and hold **Shift** and then press this button to view the Q-Link Configuration window. Press and hold **Shift** and then press this button again to return to the Main page.
6. **Rec:** Press this button to record-arm the sequence. Press **Play** or **Play Start** to start recording. Recording in this way (rather than using **Overdub**) erases the events of the current sequence. After the sequence plays through once while recording, Overdub will be enabled.  
Press and hold **Shift** and press this button to recall recently played MIDI note events when recording was disabled and insert them into the current sequence.
7. **Overdub:** Press this button to enable Overdub, which allows you to record note events in a sequence without overwriting any previously recorded note events. You can enable Overdub either before or during recording.
8. **Stop:** Press this button to stop playback. Double-press this button to immediately stop all sound.  
Press and hold **Shift** and press this button to stop playback and return the playhead to the Loop Start value.
9. **Play:** Press this button to play the sequence from the playhead's current position.
10. **Play Start:** Press this button to play the sequence from its start point.
11. **Sounds / Favorites:** Press this button to view Sounds Mode, where you can browse MPC Key 37's built-in instruments and presets.  
Press and hold **Shift** and press this button to view Favorites, where you can quickly select instruments and presets that you have defined as your favorites.
12. **Menu / Prefs:** Press this button to open the Mode Menu. You can tap an option on the Menu screen to enter that mode, view, etc.  
Press and hold **Shift** and then press this button to open the Preferences page in the Menu.
13. **Main / Track:** Press this button to view Main Mode.  
Press and hold **Shift** and press this button to view Track View Mode, an overview of the tracks of each sequence. You can also set key ranges in this mode.

14. **Edit / XYFX:** Press this button to view Program Edit Mode, which contains all parameters for editing your programs.  
Press and hold **Shift** and press this button to view XYFX Mode, which turns the touchscreen into an XY pad where each axis represents the range of an effect parameter. As you touch or move your finger on the touchscreen, the current position will determine the current value of the two parameters. You can use this mode to create interesting effect automation on your tracks.
15. **Grid / Step Seq:** Press this button to enter Grid View Mode, where you can view and edit the note events of each track of a sequence in a project and their velocities.  
Press and hold **Shift** and press this button to view Step Sequencer Mode where you can create or edit sequences by using the pads as "step buttons," simulating the experience of a traditional step-sequencer-style drum machine.
16. **Mix / Pad:** Press this button to view the Track Mixer where you can set levels, stereo panning, and other settings for your tracks, programs, returns, submixes, and main outputs.  
Press and hold **Shift** and then press this button to view the Pad Mixer where you can set a program's levels, stereo panning, routing, and effects.
17. **Undo / Redo:** Press this button to undo your last action.  
Press and hold **Shift** and press this button to redo the last action you undid.
18. **Automation / On/Off:** Press this button to toggle the Global Automation state between **Read** and **Write**.  
Press and hold **Shift** and press this button to disable or enable Global Automation.
19. **TC / On/Off:** Press this button to open the Timing Correct window, which contains various settings to help quantize the events in your sequence.  
Press and hold **Shift** and press this button to turn Timing Correct on and off.
20. **Load / Looper:** Press this button to view the Browser. You can use the Browser to locate and select programs, samples, sequences, etc.  
Press and hold **Shift** and press this button to view the Looper where you can record and overdub audio in real time—a great tool for live performance as well as spontaneous moments in the studio. You can export the loop as a sample to use in your project.
21. **Save / Save As:** Press this button to save the current project.  
Press and hold **Shift** and press this button to open the Save window.
22. **Sample Edit / Sampler:** Press this button to view Sample Edit Mode where you can edit your samples using various functions and processes.  
Press and hold **Shift** and press this button to view the Sampler where you can record audio samples to use in your projects.
23. **Shift:** Press and hold this button to access some buttons' secondary functions (indicated by white writing).
24. **Arp / Config:** Press this button to enable or disable the internal Arpeggiator, whose rate is based on the current Tempo and Time Division settings.  
Press and hold **Shift** and press this button, or press and hold this button, to configure the Arpeggiator's settings.
25. **Latch / Chord:** Press this button to enable or disable latch for the Arpeggiator. When latched, you do not have to hold the keys for the arpeggiation to continue.  
Play a chord on the keyboard and then press and hold **Shift** and press this button to enable Chord Mode. Playing any note will now play the full chord transposed to the new note with a single key press.
26. **Metronome / Config:** Press this button to enable or disable the metronome.  
Press and hold **Shift** and press this button, or press and hold this button, to open the Metronome Configuration window.
27. **Keyboard Control / MIDI CTRL:** Press this button to view the Keyboard Control menu, where you can customize the functions of the keyboard and wheels, including velocity response, routing, MIDI assignments, ranges and more.  
Press and hold **Shift** and press this button to view MIDI Control Mode, where you can use the device as a MIDI controller and customize what MIDI messages are sent from the hardware controls.
28. **Tap Tempo / Global:** Press this button in time with the desired tempo to enter a new tempo (in BPM). Press and hold this button to adjust the tempo manually using the **data dial**.  
Press and hold **Shift** and press this button to set whether the currently selected sequence follows its own tempo (the button will be lit **white**) or a global tempo (the button will be lit **red**).

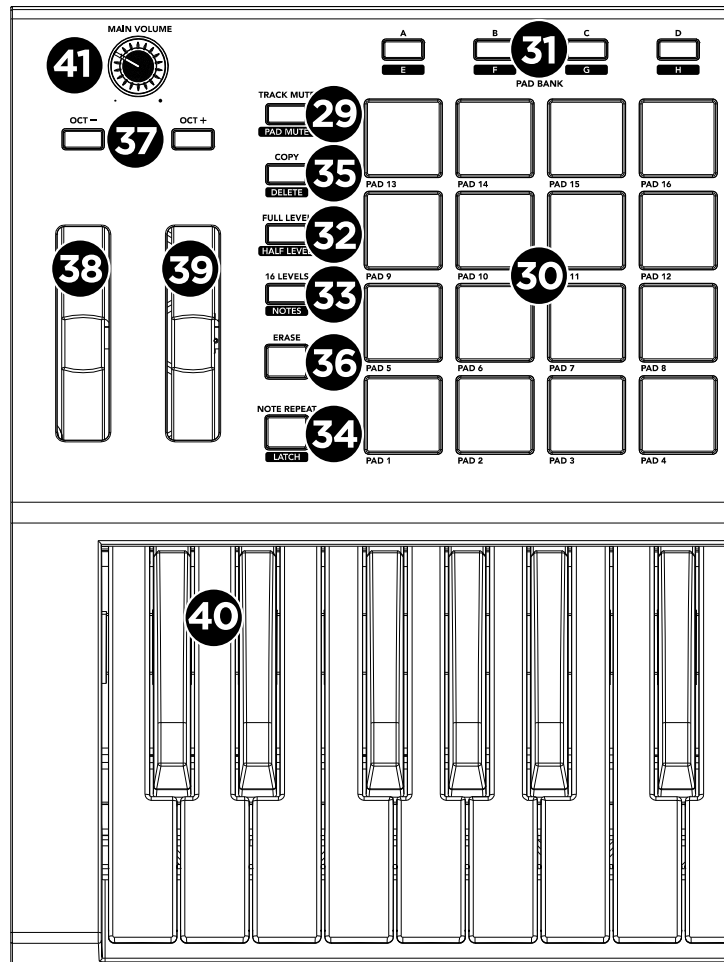

29. **Mute / Pad:** Press this button to view Track Mute Mode where you can easily mute tracks within a sequence or set mute groups for each track.

Press and hold **Shift** and press this button to view Pad Mute Mode where you can easily mute pads within a program or set mute groups for each pad within a program.

30. **Pads:** Use these pads to trigger drum hits or other samples. The pads are velocity-sensitive and pressure-sensitive, which makes them very responsive and intuitive to play. The pads will light up different colors, depending on the current function. You can also customize their colors.

31. **Pad Bank Buttons:** Press any of these buttons to access Pad Banks A–D. Press and hold **Shift** while pressing any of these buttons to access Pad Banks E–H. Alternatively, double-press one of these buttons.

32. **Full Level / Half Level:** Press this button to activate/deactivate Full Level. When activated, the pads will always trigger their samples at the maximum velocity (**127**), regardless of the amount of force you use.

Press and hold **Shift** and press this button to activate/deactivate Half Level. When activated, the pads will always trigger their samples at half-velocity (**64**).

33. **16 Level / Notes:** Press this button to activate/deactivate 16 Level. When activated, the last pad that was hit will be temporarily copied to all 16 pads. The pads will play the same sample as the original pad, but a selectable parameter will increase in value with each pad number, regardless of the amount of force you use. In the screen that appears, use the **Type** selector to choose another parameter: **Velocity**, **Tune**, **Filter**, **Layer**, **Attack** or **Decay**. See [Operation > General Features > 16 Level](#) to learn more.

Press and hold **Shift** and press this button to activate/deactivate Notes mode for the pads. When activated, you can play musical scales/modes, chords or progressions using the pads while in any mode. Use the Pad Perform window to configure the settings for the pads. See [Operation > Modes > Pad Perform Mode](#) to learn more.

34. **Note Repeat / Latch:** Press and hold this button, and then press a pad to trigger that pad's sample repeatedly. The rate is based on the current tempo and Timing Correct settings.

Press and hold **Shift** and press this button to “latch” the Note Repeat feature. When latched, you do not have to hold the Note Repeat button for it to be activated. Press **Note Repeat** once more to unlatch it.

35. **Copy / Delete:** Press this button to copy one pad to another in Clip and Drum programs. When the **From Pad** field is selected, press the “source” pad (the pad you want to copy). When the **To Pad** graphic (of all pads) is selected, press the “destination” pad. You can select multiple destination pads, and you can select pads in different pad banks. Tap **Do It** to continue or **Cancel** to return to the previous screen.
- Press and hold **Shift** and press this button to delete.
36. **Erase:** As a Sequence is playing, press and hold this button and then press a pad or key to delete the note event for that pad or key at the current playback position. This is a quick way to delete note events from your sequence without having to stop playback. When playback is stopped, press this button to open the Erase window where notes, automation and other sequence data can be erased from the sequence.
37. **Oct - / Oct +:** Press these buttons to transpose the keyboard down or up one octave at a time.
- Press and hold **Shift** and press these buttons to transpose the keyboard down or up one semitone at a time.
- Press and hold both buttons and press a key on the keybed to set the transposition to that value.
- Press and hold both buttons and release to reset the transposition.
38. **Pitch Wheel:** The pitch bend wheel is primarily used to bend the notes played on the keyboard up or down. This allows you to play phrases not normally associated with keyboard playing, such as guitar-style riffs.
39. **Modulation Wheel:** The modulation wheel is typically used to add variation for the sound you are playing. This type of real-time controller was originally introduced on electronic keyboard instruments to give the performer options such as adding vibrato, just like the players of acoustic instruments do.
40. **Keybed:** Use this 37-key semi-weighted, velocity-sensitive keybed to input notes and aftertouch.
41. **Main Volume:** Turn this knob to adjust the volume of the **outputs** and **phones output**.



## Rear Panel

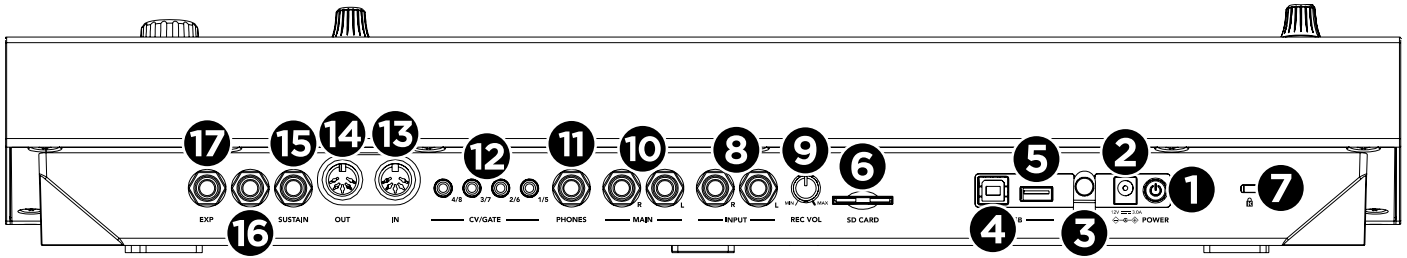

1. **Power Switch:** Turns MPC Key 37's power on/off.
2. **Power Input:** Use the included power adapter to connect MPC Key 37 to a power outlet.
3. **Power Adapter Restraint:** Secure the power adapter cable to this restraint to prevent it from accidentally unplugging.
4. **USB-B Port:** Use the included USB cable to connect this high-retention-force USB port to an available USB port on your computer. This connection allows MPC Key 37 to send/receive MIDI and audio data to/from the MPC software on your computer.
5. **USB-A Port:** Connect a USB flash drive to this USB port to access files directly using MPC Key 37. You can also connect a standard MIDI controller to this port.
6. **SD Card Slot:** Insert a standard SD, SDHC or SDXC card into this slot to access its files directly using MPC Key 37.
7. **Kensington® Lock Slot:** You can use this slot to secure your MPC Key 37 to a table or other surface.
8. **Inputs (1/4" / 6.35 mm):** Use standard 1/4" (6.35 mm) TRS cables to connect these inputs to an audio source (mixer, synthesizer, drum machine, etc.). In Sample Record Mode, you can select whether you want to record either channel or both channels in stereo or in mono.
9. **Rec Vol:** Turn this knob to adjust the volume of the **inputs**.
10. **Main Outputs (1/4" / 6.35 mm):** Use standard 1/4" (6.35 mm) TRS cables to connect these outputs to your monitors, mixer, etc.
11. **Phones (1/4" / 6.35 mm):** Connect standard stereo headphones to this output.
12. **CV/Gate Outs (1/8" / 3.5 mm, TRS):** MPC Key 37 will send control voltage (CV) and/or Gate signals over these outputs to optional external sequencers. Use standard 1/8" (3.5 mm) TS cables to send a single CV/Gate signal per output, or use a stereo TRS-to-dual mono TSF breakout cable (such as a Hosa YMM-261) to send two CV/Gate signals per output.
13. **MIDI In:** Use a standard 5-pin MIDI cable to connect this input to the MIDI output of an external MIDI device (additional MIDI keyboard, pad controller, etc.).
14. **MIDI Out:** Use a standard 5-pin MIDI cable to connect this output to the MIDI input of an external MIDI device (synthesizer, drum machine, etc.).
15. **Sustain (1/4" / 6.35 mm, TRS):** This input accepts an optional momentary-contact foot pedal. When pressed, the pedal will sustain the sound you are playing without having to keep your fingers pressed down on the keys.
16. **FS2 (1/4" / 6.35 mm, TRS):** Connect an optional 1/4" (6.35 mm) TRS footswitch or other foot pedal to this input.
17. **Expression (1/4" / 6.35 mm, TRS):** Connect an optional expression pedal to this input for adding expressive changes during performances.

## MPC Studio mk2

**Note:** This hardware differs from other MPC hardware in this manual in that it acts primarily as a controller for the MPC software. To learn more about how to use the MPC software, consult the MPC software User Guide. This can be accessed by opening the MPC software, and then navigating in the menu to **Help > MPC Help > MPC Software Manual**.

## Top Panel

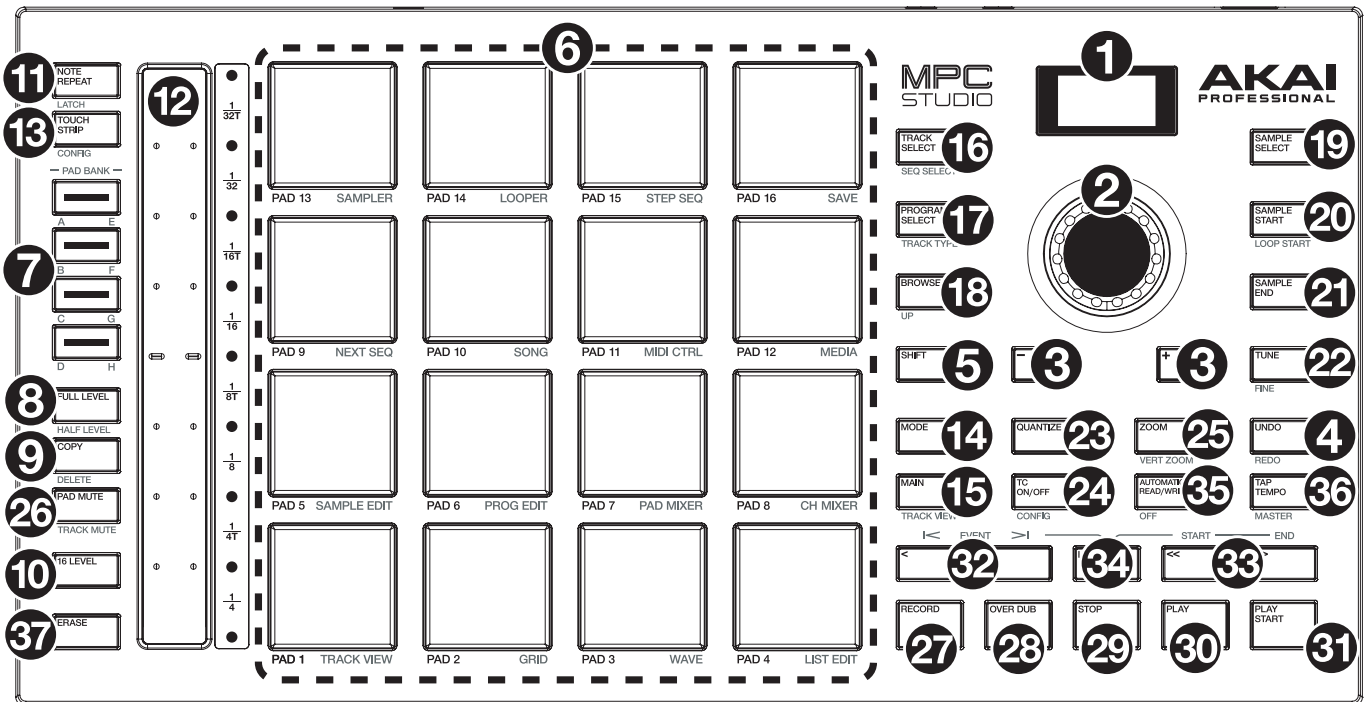

## Navigation &amp; Data Entry Controls

- Display:** This RGB LCD display shows information relevant to MPC Studio's current operation. Much of this information is also shown in the software. Use the Mode and Select buttons to change what is shown on the display, and use the **data dial** or **-/+** buttons to adjust the currently selected setting/parameter.
- Data Dial:** Use this dial to scroll through the available menu options or adjust the parameter values of the selected field in the **display**. Pressing the dial also functions as an **Enter** button.
- /+:** Press these buttons to increase or decrease the value of the selected field in the display.
- Undo / Redo:** Press this button to undo your last action.  
Press and hold **Shift** and press this button to redo the last action you undid.
- Shift:** Press and hold this button to access some buttons' secondary functions (indicated by **white** writing).

## Pad &amp; Touch Strip Controls

- Pads:** Use these pads to trigger drum hits or other samples. The pads are velocity-sensitive and pressure-sensitive, which makes them very responsive and intuitive to play. The pads will light up different colors, depending on how hard you play them (ranging from yellow at a low velocity to red at the highest velocity). You can also customize their colors.  
Press and hold the **Mode** button and press each pad to quickly jump to the mode printed below the pad in orange.
- Pad Bank Buttons:** Press any of these buttons to access Pad Banks A–D. Press and hold **Shift** while pressing any of these buttons to access Pad Banks E–H. Alternatively, double-press one of these buttons.
- Full Level / Half Level:** Press this button to activate/deactivate Full Level. When activated, the pads will always trigger their samples at the maximum velocity (**127**), regardless of the amount of force you use.  
Press and hold **Shift** and then press this button to activate/deactivate Half Level. When activated, the pads will always trigger their samples at half-velocity (**64**).

9. **Copy / Delete:** Press this button to copy one pad to another. Use the **Copy from pad** field to select the “source” pad (the pad you want to copy) and use the **Copy to pad** field to select the “destination” pad. You can select multiple destination pads, and you can select pads in different pad banks. Tap **Do It** to continue or **Cancel** to return to the previous screen.

Press and hold **Shift** and press this button to view the **Delete Pad** window, where you can delete the contents of a selected pad.

10. **16 Level:** Press this button to activate/deactivate 16 Level. When activated, the last pad that was hit will be temporarily copied to all 16 pads. The pads will play the same sample as the original pad, but a selectable parameter will increase in value with each pad number, regardless of the amount of force you use. Use the **data dial** or **-/+ buttons** to select the 16 Level parameter.

Press and hold **Shift** and press this button to cycle through editing the Pad Perform Notes Type, Root Note, and starting Octave. Use the **data dial** or **-/+ buttons** to adjust the parameter shown on the **display**.

11. **Note Repeat / Latch:** Press and hold this button, and then press a pad to trigger that pad’s sample repeatedly. The rate is based on the current tempo and Time Correct settings.

Press and hold **Shift** and then press this button to “latch” the Note Repeat feature. When latched, you do not have to hold the Note Repeat button for it to be activated. Press **Note Repeat** once more to unlatch it.

You can also change the note repeat rate using the **Touch Strip**.

12. **Touch Strip:** The touch strip can be used as an expressive control for playing and can be configured to control Note Repeat, Pitch Bend, Modulation, Touch FX and more. See [Appendix > Updates in MPC 2.10.1 > New Features > Touch Strip and Touch FX](#) for more information.

13. **Touch Strip / Config:** Press this button to enable Touch Strip mode selection. Press the button repeatedly or use the **data dial** or **-/+ buttons** to cycle between the available modes. Press and hold this button to enter Q-Link mode for the Touch Strip.

Press and hold **Shift** and press this button to view the Touch Strip Configuration window.

## Mode & View Controls

14. **Mode:** Press and hold this button and then press a pad to quickly jump to the mode printed below the pad in orange:

|                                   |                                    |                                     |                                      |
|-----------------------------------|------------------------------------|-------------------------------------|--------------------------------------|
| <b>Pad 13:</b><br>Sampler         | <b>Pad 14:</b><br>Looper           | <b>Pad 15:</b><br>Step Sequencer    | <b>Pad 16:</b><br>Save               |
| <b>Pad 9:</b><br>Next Sequence    | <b>Pad 10:</b><br>Song Mode        | <b>Pad 11:</b><br>MIDI Control Mode | <b>Pad 12:</b><br>Media/Browser Mode |
| <b>Pad 5:</b><br>Sample Edit Mode | <b>Pad 6:</b><br>Program Edit Mode | <b>Pad 7:</b><br>Pad Mixer          | <b>Pad 8:</b><br>Channel Mixer       |
| <b>Pad 1:</b><br>Track View       | <b>Pad 2:</b><br>Grid Editor       | <b>Pad 3:</b><br>Wave Editor        | <b>Pad 4:</b><br>List Editor         |

15. **Main / Track View:** Press this button to enter Main Mode.

Press and hold **Shift** and then press this button to enter Track View Mode.

16. **Track Select / Seq Select:** Press this button to toggle between viewing **MIDI Tracks** and **Audio Tracks**, and then use the **data dial** or **-/+ buttons** to change the selected track.

Press and hold **Shift**, press this button and use the **data dial** or **-/+ buttons** to change the selected Sequence.

17. **Program Select / Track Type:** Press this button and use the **data dial** or **-/+ buttons** to change the Program for the selected track.  
Press and hold **Shift**, press this button and use the **data dial** or **-/+ buttons** to change the track type for the selected track: Drum, Keygroup, Plugin, MIDI, Clip or CV.
18. **Browse / Up:** Press this button once to open the File Browser, and press it again to open the Media Browser. You can use the Browsers to locate and select programs, samples, sequences, etc.  
Press and hold **Shift** and then press this button to move up to the previous folder while using the Browser.
19. **Sample Select:** Press this button and use the **data dial** or **-/+ buttons** to change the selected sample for the current pad. Press the button again to cycle between Layers 1–4 of the pad.
20. **Sample Start / Loop Start:** Press this button and use the **data dial** or **-/+ buttons** to change the sample start point for the sample on the selected pad. Press the button again to cycle through Layers 1–4 of the pad.  
Press and hold **Shift**, press this button, and use the **data dial** or **-/+ buttons** to change the Loop Start point for the sample on the selected pad. Press and hold **Shift** and press the button again to cycle through Layers 1–4 of the pad.
21. **Sample End:** Press this button and use the **data dial** or **-/+ buttons** to change the sample end point for the sample on the selected pad. Press the button again to cycle through Layers 1–4 of the pad.
22. **Tune / Fine:** Press this button and use the **data dial** or **-/+ buttons** to change the Tuning for the sample on the selected pad. Press the button again to cycle through Layers 1–4 of the pad.  
Press and hold **Shift**, press this button, and use the **data dial** or **-/+ buttons** to change the Fine Tuning for the sample on the selected pad. Press and hold **Shift** and press the button again to cycle through Layers 1–4 of the pad.
23. **Quantize:** Press this button to quantize all note events so they fall on exact, even time intervals as determined by the Timing Correct settings.  
Press and hold **Shift** and press this button to quantize only the currently selected note events.
24. **TC On/Off / Config:** Press this button to turn Timing Correct on and off.  
Press and hold **Shift** and press this button to toggle between viewing the Time Division and Swing settings for Timing Correct in the display. Use the **data dial** or **-/+ buttons** to change the selected value.
25. **Zoom / Vert Zoom:** Press this button and use the **data dial** or **-/+ buttons** to change the horizontal zoom level.  
Press and hold **Shift**, press this button and use the **data dial** or **-/+ buttons** to change the vertical zoom level.
26. **Pad Mute / Track Mute:** Press this button to view Pad Mute Mode where you can easily mute pads within a program or set mute groups for each pad within a program.  
Press and hold **Shift** and press this button to view Track Mute Mode where you can easily mute tracks within a sequence or set mute groups for each track.

## Transport & Recording Controls

27. **Record:** Press this button to record-arm the sequence. Press **Play** or **Play Start** to start recording. Recording in this way (as opposed to using **Overdub**) erases the events of the current sequence. After the sequence plays through once while recording, Overdub will be enabled.
28. **Overdub:** Press this button to enable Overdub. When enabled, you can record events in a Sequence without overwriting any previously recorded events. You can enable Overdub before or during recording.
29. **Stop:** Press this button to stop playback. You can double-press this button to silence audio that is still sounding once a note stops playing. Press and hold **Shift** and press this button to return the playhead to 1:1:0.
30. **Play:** Press this button to play the sequence from the playhead's current position.
31. **Play Start:** Press this button to play the sequence from its start point.
32. **Step </> (Event |</>):** Use these buttons to move the playhead left or right, one step at a time.  
Press and hold **Locate** and press one of these buttons to move the playhead to the previous/next event in the sequence grid.
33. **Bar <</>> (Start/End):** Use these buttons to move the playhead left or right, one bar at a time.  
Press and hold **Locate** and press one of these buttons to move the playhead to the start or end of the sequence grid.

34. **Locate:** Press this button and then use the pads to add and select locator markers in the timeline. When on, tap Pads 9-14 to set up to six locators on the timeline, and tap Pads 1-6 to jump to each locator.

Additionally, the current playhead position will be shown on the **display** in **Bars : Beats : Ticks** when this button is activated. Use the **data dial** or **-/+** buttons to move the playhead left or right one beat at a time or press and hold **Shift** and use the **data dial** or **-/+** buttons to move the playhead left or right one tick at a time.

To deactivate Locate, enter another display mode (such as Track Select, Program Select, etc.).

35. **Automation Read/Write:** Press this button to toggle the Global Automation state between **Read** and **Write**.

Press and hold **Shift** and press this button to disable or enable Global Automation.

36. **Tap Tempo / Master:** Press this button in time with the desired tempo to enter a new tempo (in BPM). Alternatively, press and hold this button and then use the **data dial** or **-/+** buttons to coarsely adjust the tempo. Press and hold both **Shift** and this button and then use the **data dial** or **-/+** buttons to finely adjust the tempo.

Press and hold **Shift** and press this button to set whether the currently selected sequence follows its own tempo (the button will be lit **white**) or a global tempo (the button will be lit **red**).

37. **Erase:** As a Sequence is playing, press and hold this button and then press a pad to delete the note event for that pad at the current playback position. This is a quick way to delete note events from your sequence without having to stop playback. When playback is stopped, press this button to open the Erase window where notes, automation and other sequence data can be erased from the sequence.

## Rear Panel

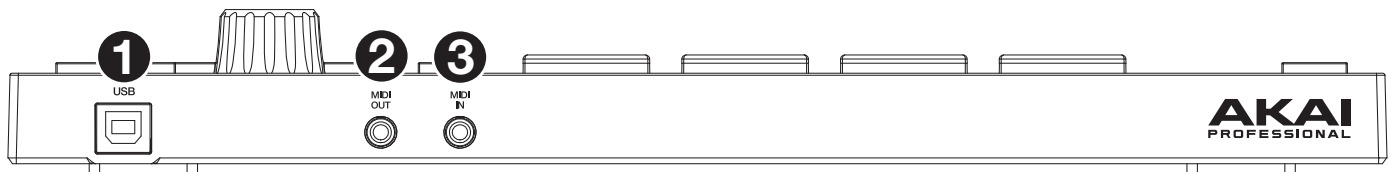

1. **USB-B Port:** Use the included USB cable to connect this high-retention-force USB port to an available USB port on your computer. This connection allows MPC Studio to send/receive MIDI data to/from the MPC software on your computer.
2. **MIDI Out:** Use the included 1/8"-to-MIDI adapter and a standard 5-pin MIDI cable (not included) to connect this output to the MIDI input of an external MIDI device (synthesizer, drum machine, etc.).
3. **MIDI In:** Use the included 1/8"-to-MIDI adapter and a standard 5-pin MIDI cable (not included) to connect this input to the MIDI output of an external MIDI device (synthesizer, drum machine, etc.).

## MPC Touch

## Top Panel

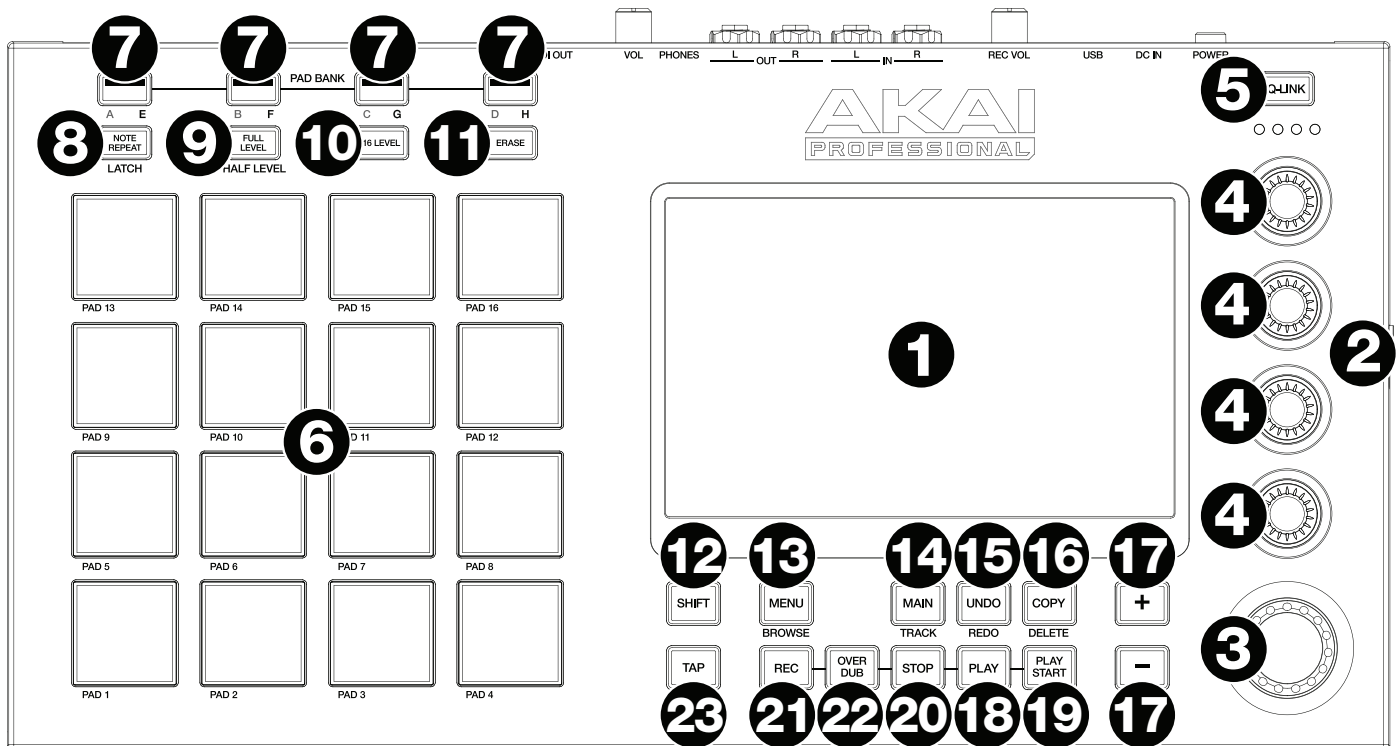

- 1. Touchscreen:** This full-color multi-touch display shows information relevant to MPC Touch's current operation. Touch the touchscreen (and use the hardware controls) to control the MPC interface. See the previous [Touchscreens](#) section to learn how to use some basic functions.
- 2. Display Brightness +/-:** Use these buttons to increase/decrease the brightness of the touchscreen.
- 3. Data Dial:** Use this dial to scroll through the available menu options or adjust the parameter values of the selected field in the screen.
- 4. Q-Link Knobs:** Use these touch-sensitive knobs to adjust various parameters and settings. The knobs can control one group of parameters at a time. The lights below the Q-Link button indicate the currently selected column of Q-Link knobs. Press the **Q-Link** button to change which parameter or group of parameters they currently control.
- 5. Q-Link Button:** Press this button to change which parameter or group of parameters the **Q-Link knobs** currently control (indicated by the lights above the Q-Link knobs). Each press will select the next column of Q-Link knobs.

Press and hold **Shift** and then press this button to select the previous column of Q-Link knobs instead.

Press and hold this button to show the **Q-Link** window over the touchscreen's current contents. These are the same parameters and settings as what is shown in Q-Link Edit Mode. You can tap **Q-Link Edit** at the bottom of the window to enter Q-Link Edit Mode immediately (see [Operation > Modes > Q-Link Edit Mode](#) to learn about this).

- 6. Pads:** Press these pads to trigger drum hits or other samples in your software. The pads are velocity-sensitive and pressure-sensitive, which makes them very responsive and intuitive to play. The pads will light up different colors, depending on how hard you play them (ranging from yellow at a low velocity to red at the highest velocity). You can also customize their colors.
- 7. Pad Bank:** Press any of these buttons to access Pad Banks A–D.  
Press and hold **Shift** while pressing any of these buttons to access Pad Banks E–H. Alternatively, double-press one of these buttons.
- 8. Note Repeat/Latch:** Press and hold this button, and then press a pad to trigger that pad's sample repeatedly. The rate is based on the current tempo and Time Correct settings.

Press and hold **Shift** and then press this button to "latch" the Note Repeat feature. When latched, you do not have to hold the Note Repeat button for it to be activated. Press **Note Repeat** once more to unlatch it.

9. **Full Level/Half Level:** Press this button to activate or deactivate the Full Level feature. When activated, the pads will always trigger their samples at the maximum velocity (**127**), regardless of how much force you use.  
  
Press and hold **Shift** and then press this button to activate or deactivate the Half Level feature. When activated, the pads will always trigger their samples at half-velocity (**64**).
10. **16 Level / Pad Perform:** Press this button to activate/deactivate 16 Level. When activated, the last pad that was hit will be temporarily copied to all 16 pads. The pads will now output the same note number as the initial pad, but a selectable parameter will be fixed at values that increase as the pad numbers increase (e.g., Pad 1 is the minimum, Pad 16 is the maximum), regardless of how hard you press them. In the screen that appears, use the **Type** selector to choose the parameter: **Velocity**, **Tune**, **Filter**, **Layer**, **Attack** or **Decay**. See [Operation > General Features > 16 Level](#) to learn more.  
  
Press and hold **Shift** and press this button to enter Pad Perform mode for the pads. When activated, you can play musical scales/modes, chords or progressions using the pads while in any mode. See [Operation > Modes > Pad Perform Mode](#) to learn more.
11. **Erase:** As a sequence is playing, press and hold this button and then press a pad to delete the note event for that pad at the current playback position. This is a quick way to delete note events from your sequence without having to stop playback. See [Operation > General Features > Erase](#) to learn more.
12. **Shift:** Press and hold this button to access some buttons' secondary functions (indicated by **gray** writing).  
  
Double-press this button to see which buttons have secondary functions—the buttons will flash for a few seconds.
13. **Menu/Browse:** Press this button to open the Menu. You can tap an option in the Menu to enter that mode, view, etc.  
  
Press and hold **Shift** and then press this button to view the Browser. You can use the Browser to locate and select programs, samples, sequences, etc.
14. **Main/Track:** Press this button to enter Main Mode.  
  
Press and hold **Shift** and then press this button to enter the Track View.
15. **Undo/Redo:** Press this button to undo your last action.  
  
Press and hold **Shift** and press this button to redo the last action you undid.
16. **Copy/Delete:** Press this button to copy one pad to another. When the **From Pad** field is selected, press the “source” pad (the pad you want to copy). When the **To Pad** graphic (of all pads) is selected, press the “destination” pad. You can select multiple destination pads, and you can select pads in different pad banks. Tap **Do It** to continue or **Close** to return to the previous screen.  
  
**Tip: To quickly copy a pad**, press and hold **Copy**, press the source pad, press the destination pad, and then release **Copy**.  
  
Press and hold **Shift** and press this button to delete a pad's sample assignment. When the **Delete Pad** window is shown, press any pad/pads whose sample assignments you want to clear. Tap **Delete** to continue or **Cancel** to return to the previous screen.
17. **-/+:** Press these buttons to increase or decrease the value of the selected field in the screen.
18. **Play:** Press this button to play the sequence from the playhead's current position.
19. **Play Start:** Press this button to play the sequence from its start point.
20. **Stop:** Press this button to stop playback. You can double-press this button to silence audio that is still sounding once a note stops playing. Quickly pressing this button three times will act as a “MIDI panic” and shut off all voices and stop all audio processing.
21. **Rec:** Press this button to record-arm the sequence. Press **Play** or **Play Start** to start recording. Recording in this way (as opposed to using **Overdub**) erases the events of the current sequence. After the sequence plays through once while recording, **Overdub** will be enabled.
22. **Overdub:** Press this button to enable **Overdub**. When enabled, you can record events in a sequence without overwriting any previously recorded events. You can enable **Overdub** before or during recording.
23. **Tap/Master:** Press this button in time with the desired tempo to enter a new tempo (in BPM). You can set how many taps are required in the Preferences (see [Operation > General Features > Menu > Preferences](#) to learn how to do this).  
  
Press and hold **Shift** and press this button to set whether the currently selected sequence follows its own tempo (the button will be lit **red**) or a global tempo (the button will be lit **amber**).

## Rear Panel

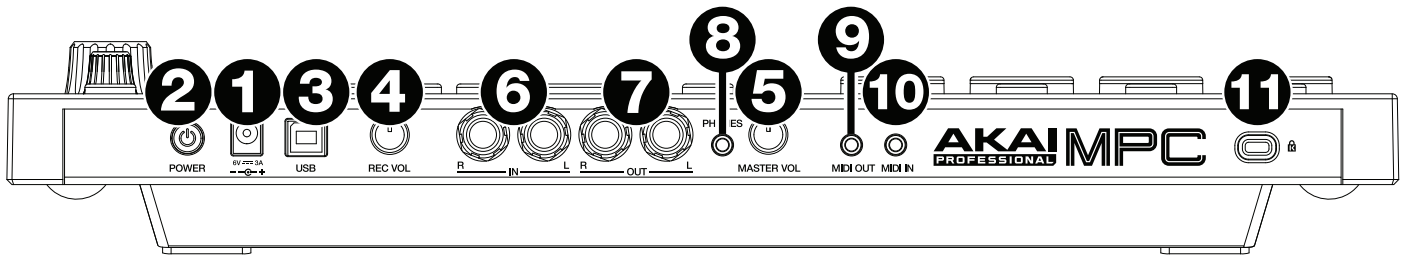

1. **Power Input:** Use the included power adapter to connect MPC Touch to a power outlet.
2. **Power Switch:** Turns MPC Touch's power on/off.
3. **USB Port:** Use the included USB cable to connect this high-retention-force USB port to an available USB port on your computer. This connection allows MPC Touch to send/receive MIDI and audio data to/from the MPC software. You can power MPC Touch via the USB port only, but the touchscreen will be disabled.
4. **Rec Vol:** Turn this knob to adjust the gain of the incoming signal from the **inputs**. Be careful when setting this knob at higher levels, which can cause the signal to distort.
5. **Master Vol:** Turn this knob to adjust the volume of the **outputs** and **phones output**.
6. **Inputs** (1/4" / 6.35 mm): Use standard 1/4" (6.35 mm) TRS cables to connect these inputs to audio sources (microphone, mixer, synthesizer, etc.). Turn the **Rec Vol** knob to set their input levels.
7. **Outputs** (1/4" / 6.35 mm): Use standard 1/4" (6.35 mm) TRS cables to connect these outputs to your speaker system, external mixer, etc. The signal sent out of these outputs is the main mix. Turn the **Master Vol** knob to set the volume level.
 

**Tip:** To route a program to these outputs, set its routing to **Out 1,2** in the **Channel Mixer** when the **Mixer** field is set to **Programs**. See [Operation > Modes > Channel Mixer](#) to learn more about this.
8. **Phones** (1/8" / 3.5 mm): Connect standard 1/8" (3.5 mm) stereo headphones to this output. Turn the **Master Vol** knob to set the volume level.
9. **MIDI Out** (1/8" / 3.5 mm): Use the included 1/8"-to-5-pin adapter and a five-pin MIDI cable to connect this output to the MIDI input of an optional external MIDI device.
 

**Important:** Do **not** connect audio devices (e.g., headphones, monitors, etc.) to the **MIDI Out**. Use the included 1/8"-to-5-pin adapters to connect MIDI devices only.
10. **MIDI In** (1/8" / 3.5 mm): Use the included 1/8"-to-5-pin adapter and a five-pin MIDI cable to connect this input to the MIDI output of an optional external MIDI device.
 

**Important:** Do **not** connect audio devices (e.g., headphones, monitors, etc.) to the **MIDI In**. Use the included 1/8"-to-5-pin adapters to connect MIDI devices only.
11. **Kensington® Lock Slot:** You can use this slot to secure your MPC Touch to a table or other surface.



## Basic Concepts

This chapter should help explain some fundamental aspects of the MPC universe.

The MPC workflow is quite different from traditional digital audio workstations (DAWs). In most typical DAWs, each track uses an instance of each instrument, and all tracks are always playing even if they don't contain any audio or MIDI information. Furthermore, your entire project needs to be arranged just as the resulting song would be. This isn't the case with MPC, which offers much more flexibility within your project. It's important to understand some basic terms, though:

A **sequence** is a "building block" of a song. It contains multiple tracks that play at the same time like a normal DAW. In a project, you might create one sequence for your verse and another sequence for your chorus, alternating and/or repeating each one in a specific order to create the song. (A project can contain **128 sequences**.)

A **track** is a layer in a sequence. There are two types of tracks:

**MIDI tracks** consist of MIDI data only, no audio data. These tracks produce sound by using **programs**, described below. Unlike a normal DAW, each MIDI track exists only in its sequence. The advantage of this is not having to manage empty or unwanted tracks across all of your sequences—each sequence contains only the tracks you want to use in it. If you want to use the same track across multiple sequences, you can copy the track from one sequence into another. (A sequence can contain **128 MIDI tracks**.)

**Audio tracks** consist of a recorded audio signal, like a traditional DAW. These tracks do **not** use programs because the audio is already contained in the track. Also, unlike MIDI tracks, audio tracks are present in every sequence in the project, even if the tracks themselves are empty. (A sequence on your MPC hardware can contain **8 audio tracks**. A sequence in the MPC software can contain **128 audio tracks**.)

A **program** is a preset through which MIDI tracks are routed. Programs may contain audio samples that are triggered when tracks play through them, producing the sound you want on that track. Programs are independent of tracks and sequences, so you can set multiple tracks to use the same program (unlike normal DAWs where each track requires its own set of samples). Furthermore, you can use the same program/programs across multiple sequences. (A project can contain **128 programs**.)

Each program can be played using the **16 pads** (across eight pad banks, which gives you access to **128 pads in each program**). Each pad plays a MIDI note when you press it, but that MIDI note will trigger something different for each program. For instance, in drum programs, the pads are assigned to samples—one pad could trigger a kick drum sound and another could trigger a snare drum sound—whereas in keygroup programs, each pad triggers a MIDI note that plays the corresponding pitch of the sample assigned to its keygroup.

Here's a diagram to illustrate an example of how these pieces could work together:

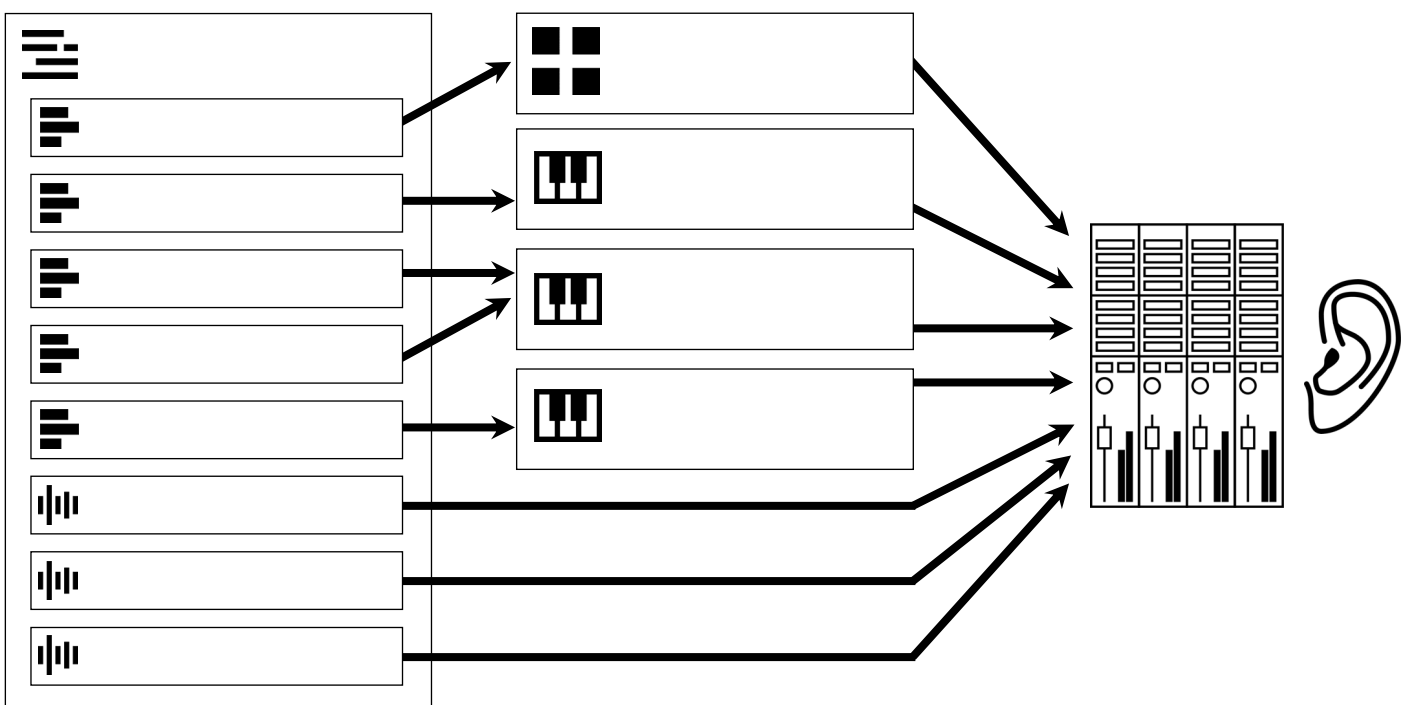

Please take a look at the following [Tutorial](#) chapter, as well. It will walk you through the creation of a short song to show you some of your MPC hardware's most important features.

## Tutorial

This chapter should familiarize you with some basic MPC features. We'll create a short song to illustrate some of the most important features. To get the most out of this chapter, we recommend reproducing each of the described steps.

**Note:** Mentions of the features and functions of MPC X and MPC One hardware throughout this guide also apply to the MPC X Special Edition and MPC One+, respectively, unless otherwise noted.

## Starting Up

Make sure you have completed all of the steps described in [Introduction > Setup](#). This includes:

- Installing the most current drivers and software.
- Connecting your MPC hardware to a power source using the included power adapter (if required) and powering it on.
- Opening and authorizing your MPC software (if you are using your MPC hardware as a controller).

## Creating a Drum Kit

Let's start by making a simple drum kit.

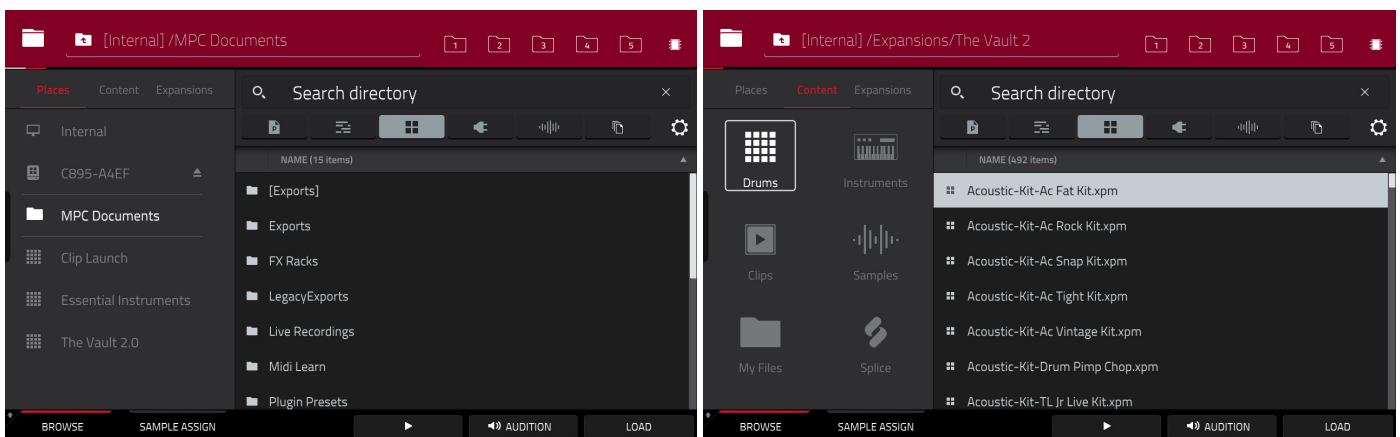

Press **Browse** (MPC X, MPC One, MPC Live II) or **Shift+Menu/Browse** (MPC Live, MPC Live II, MPC Touch) to show the Browser. Then, use the touchscreen to navigate to where your drum sounds are located:

**To browse your files by location**, tap **Places** on the left side of the screen.

**Internal** is the internal drive of MPC X/Live/Live II/One/Key 61/Key 37.

**MPC Documents** is a shortcut to the **MPC Documents** folder on the internal drive of MPC X/Live/Live II/One/Key 61/Key 37.

If you have storage devices connected to USB ports or SD card slot of your MPC hardware, or your computer (with MPC Live II and MPC Touch), they will appear in this column, as well.

**Important:** MPC hardware supports read and write capability for **exFAT**, **FAT32**, **NTFS**, and **EXT4** file systems as well as read-only capability for **HFS+** file systems. (We recommend using an exFAT file system as it is the most robust one supported by both Windows and macOS.)

**To browse your files by type**, tap **Content** and then tap the type of file: **Drums**, **Instruments**, **Clips**, **Samples**, **Demos**, or **My Files**.

**To browse your MPC Expansions** (MPC X/Live/Live II/One/Key 61/Key 37 only), tap **Expansions** (see [Addenda > Updates in MPC 2.1 > New Features > Exporting Expansions](#) to learn how to export MPC Expansions from your computer to your supported MPC hardware.

**To move up one folder level**, tap the **folder/↑ icon** in the upper-left corner.

**To move through a list**, swipe up or down, turn the **data dial** or use the **-/+ buttons**.

**To select a file or folder**, tap it once.

**To enter a folder**, double-tap it or tap **Open** in the lower-right corner. Alternatively, press the **data dial**, or press the **center cursor** or **Enter** (MPC X), to enter a selected folder.

**To load a selected file**, double-tap it, tap **Load**, press the **data dial**, or press the **center cursor** or **Enter** (MPC X). If the file is a sample, it will be loaded to the project's sample pool. If the file is a project, it will be loaded in its entirety (you will be asked if you want to close your current project).

**To load all files in a folder**, select the folder (so it is highlighted in the list), press and hold **Shift**, and then tap **Load All** in the lower-right corner.

**Important:** Although you can load multiple files at once, any samples you load into a project will be automatically converted to full-quality uncompressed audio files, so they may use more storage space than they do on your external storage device. If you are unable to load multiple files at once due to this, select fewer files and try again.

**To delete a selected file or folder**, press and hold **Shift** and then tap **Delete File** at the bottom of the screen.

**To preview a selected sound**, tap and hold **Play** (▶) at the bottom of the screen.

**To enable or disable the audition function and set its volume level**, tap **Audition** at the bottom of the screen. In the screen that appears, tap **Auto** to enable or disable it, and tap and drag the **level slider** up or down to set the volume level. Tap **Audition** once more to hide the window.

**To show the information for the current drive** (MPC X, MPC Live, MPC Live II, MPC One, MPC Key 61, MPC Key 37), press and hold **Shift** and then tap **Drive Info** at the bottom of the screen. The drive's information will appear in a new window. Tap **OK** to return to the previous screen.

After loading samples for a drum kit into the sample pool, use the **Sample Assign** tab to assign a kick drum sound to a pad:

1. Tap **Sample Assign** at the bottom of the screen. This lets you view the pads and project's sample pool.
2. Press **Pad 1** or tap **Pad 1** on the screen to select it. The pad will be lit green.
3. Swipe the **Sample Pool** list up or down or use the **data dial** or **-/+** buttons to move through it.
4. **To load a sample to the selected pad (Pad 1**, in this case) tap it in the **Sample Pool** list, press the **data dial**, or press the **center cursor** or **Enter** (MPC X). Now, you can press **Pad 1** to play the kick drum sample.

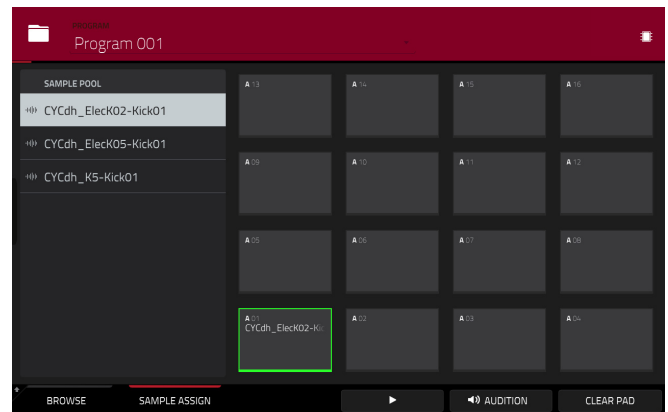

**To create a simple drum kit**, repeat the above steps for other pads. We recommend loading a snare drum, a closed hi-hat, and an open hi-hat.

## Creating a Drum Sequence

Now that your drum kit is set up, let's record a drum sequence.

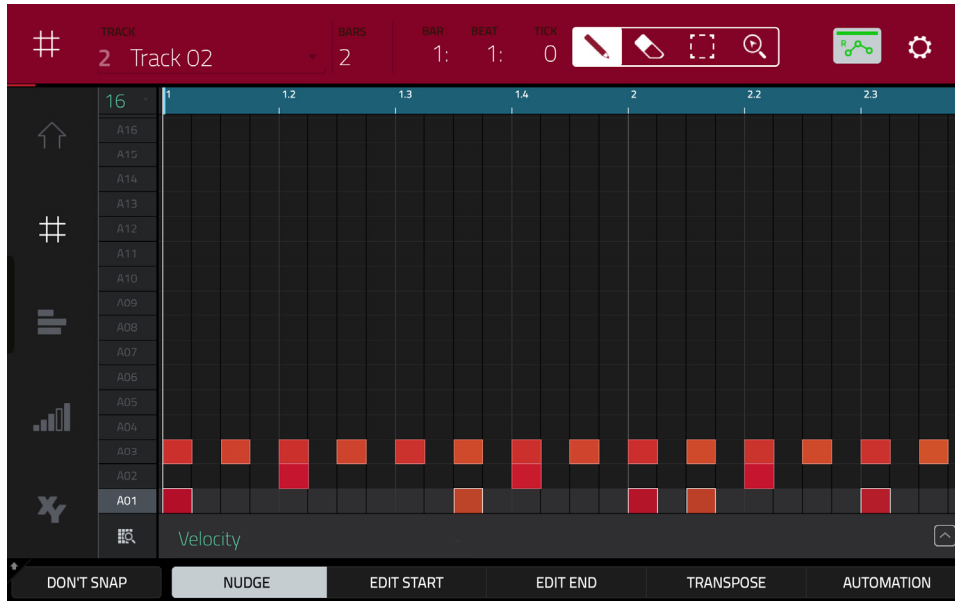

1. Press **Menu** to enter the Menu, and then tap **Grid View**.
2. Press **Tap** repeatedly at the speed you want to record your sequence. Your MPC hardware will detect the rate and adjust itself automatically.
3. Press the **Rec** button to record-arm the sequence.
4. Press the **Play** button to start the actual recording. You will hear the count-in for one measure before the recording starts. We recommend recording only one sound (pad) at a time, especially if you're not familiar with playing drums on the pads.
5. Play a simple kick drum pattern. The note events you just recorded will automatically be placed in the grid (in this case, on 16th notes). The initial measure length is two bars. After the two bars, the recording will automatically activate Overdub; the sequence will play again from the beginning and keeps looping, allowing you to record further notes. Don't stop the recording!
6. Play the snare drum part, then a hi-hat part.
7. When you're done recording, press the **Stop** button.

If you start recording again on this sequence, keep in mind that the pads you play in your new recording will replace existing notes played with the same pads. To prevent this, press the **Overdub** button before recording instead of the Rec button. Overdub lets you record additional note events over the existing sequence.

The **Undo** button functions differently while recording. Normally, pressing **Undo** will undo just the last event. When there is an event to undo, the **Undo** button will be lit solid. While recording, the **Undo** button will flash. In this case, pressing **Undo** will erase **all** events from that recording (i.e., since **Play** or **Play Start** was pressed).

## Saving & Renaming

We recommend doing some renaming of your programs and samples before going further.

The collection of drum samples you loaded earlier (and their respective pad assignments) are arranged into a program. When you load this program in the future, you will be able to use all of the samples that belong to it.

Let's rename the existing program as we'll want to create more programs later on.

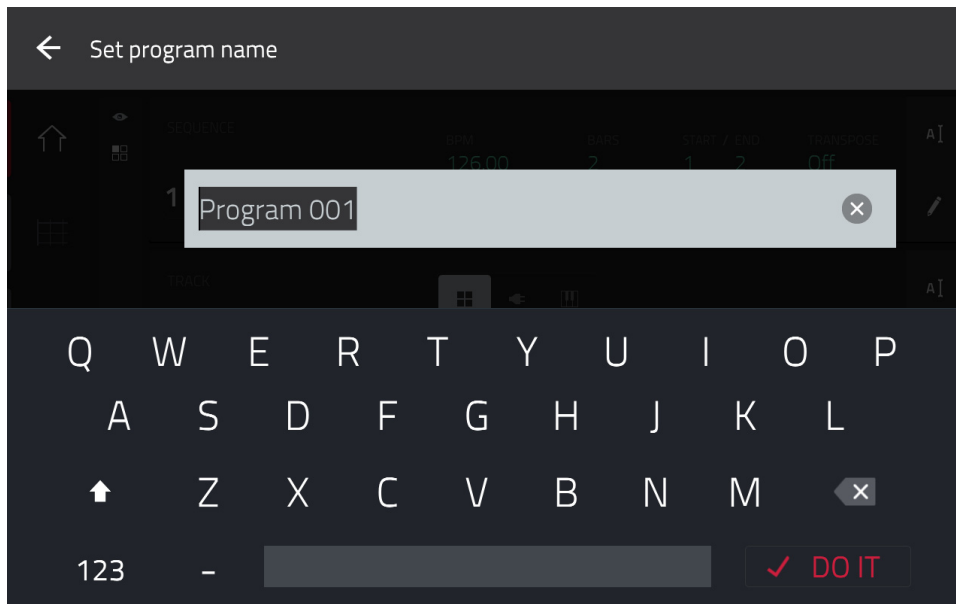

### To rename a program:

1. Press **Main** to enter Main Mode.
2. In the **Program** section in the lower part of the screen, tap the **cursor icon** on the right edge.
3. Use the virtual keyboard that appears to enter a new name (e.g., **Drums**), and then tap **Do It**.

### To rename your samples:

1. Press **Menu** to enter the Menu, and then tap **Sample Edit** to enter Sample Edit Mode.
2. The **Sample** field at the top of the screen will show the name of a sample. Select a sample in one of the following ways:
  - When the **Sample** field is selected, use the **data dial** or **-/+** buttons to change it.
  - Double-tap the **Sample** field and tap one in the list that appears.
3. Tap the **keyboard icon** next to it to rename the current sample.
4. Use the virtual keyboard that appears to enter a new name (e.g., **Kick**, **Snare**, etc.), and then tap **Do It**.  
Repeat Steps 2–4 to rename other samples.

Now would be a good time to save your project.

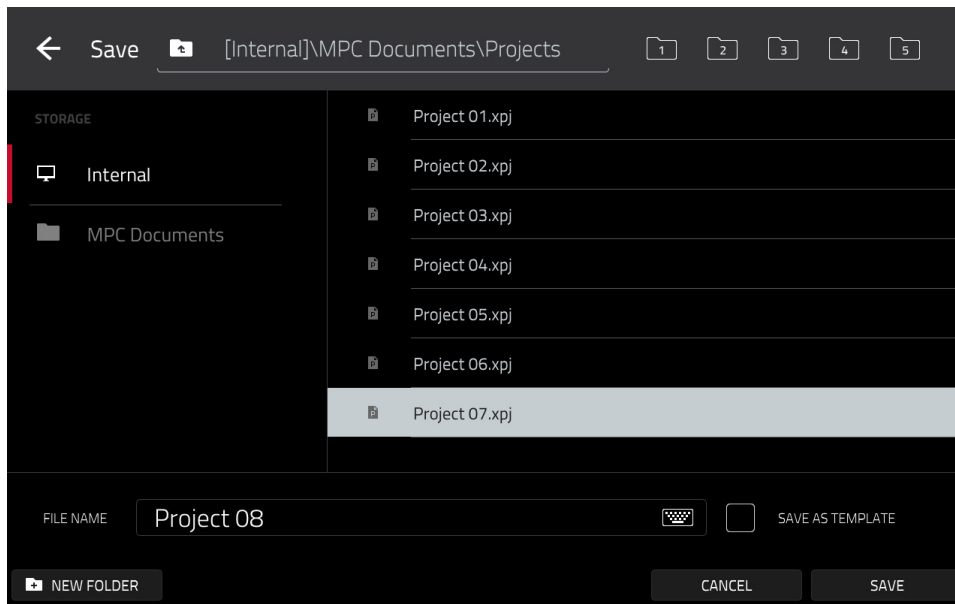

**To save your project**, press **Menu** to show the Menu, and tap the **Save** at the bottom of the screen to open the **Save** window. Alternatively, press **Shift+Browse/Save** (MPC X, MPC One). In the Save window, do any of the following:

**To select the storage device you want to view**, tap it in the **Storage** column on the left.

**Internal** is the internal drive of MPC X/Live/Live II/One/Key 61/Key 37.

**MPC Documents** is a shortcut to the **MPC Documents** folder on the internal drive of your MPC hardware.

If you have storage devices connected to USB ports or SD card slot of your MPC hardware, or your computer (with MPC Studio or MPC Touch), they will appear in this column, as well.

**To enter a folder**, double-tap it. Alternatively, turn the **data dial** or use the **-/+** buttons to move through the list, and press the **data dial**, or the **center cursor** or **Enter** (MPC X), to enter a folder. You can also tap one of the five **folder buttons** in the upper-right to jump immediately to those pre-assigned file paths (see [Operation > Modes > Browser](#) to learn how to do this).

**To create a new folder**, tap **New Folder**, use the virtual keyboard that appears to enter a name, and then tap **Do It**. You will immediately enter the new folder.

**To move up one folder level**, tap the **folder/↑ icon** in the upper-left corner.

**To name the file**, tap the **File Name** field at the bottom of the screen, and use the virtual keyboard that appears.

**To save the file**, tap **Save**.

**To cancel and return to the Menu**, tap **Cancel**. Alternatively, tap the **← icon** in the upper-left corner.

## Editing Note Events

In the grid, you can see your recorded notes (or note events) as a sequence.

To enter the Grid View, press **Menu**, and then tap **Grid View**.

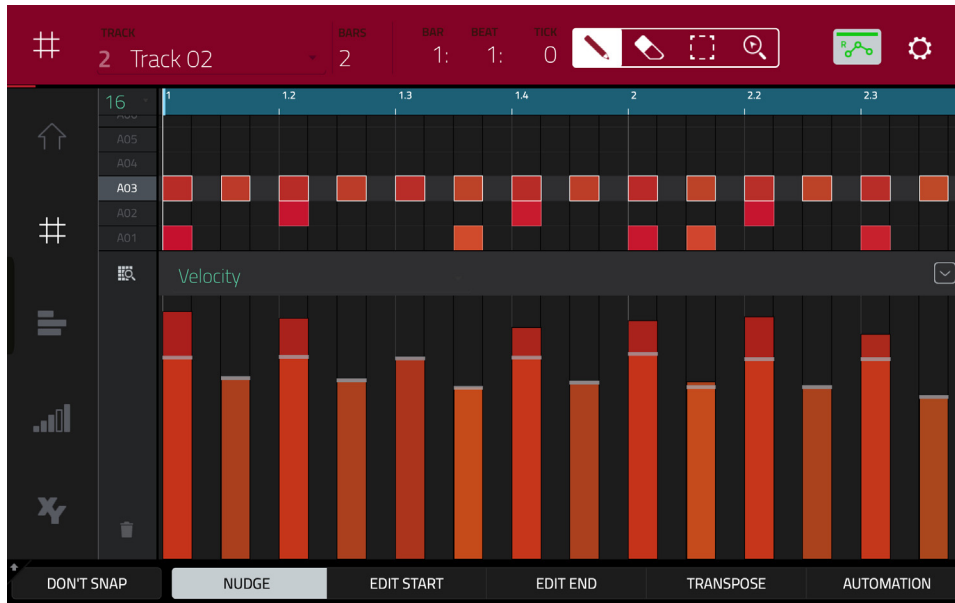

In the Grid View, you can do any of the following:

**To zoom in or out**, tap the **magnifying-glass icon** in the upper-right corner. Then, in the grid, spread two fingers apart or pinch two fingers together. You can do this for each axis, horizontal or vertical.

**To automatically set the grid to view one pad bank and two bars**, tap the **grid-and-magnifying-glass icon** in the lower-left corner.

**To undo your last action**, press **Undo**.

**To redo the last action you undid**, press **Shift+Undo/Redo**.

**To enter a note**, tap the **pencil icon** in the upper-right corner. Then, in the grid, tap a square.

**To delete a note**, tap the **eraser icon** in the upper-right corner. Then, in the grid, tap a note.

**To select a single note**, tap the **select box** in the upper-right corner. Then, in the grid, tap the note.

**To select all notes for a pad**, press the desired **pad**.

**To move the selected notes**, tap **Nudge** at the bottom of the screen, and then use the **data dial** or **-/+** buttons to shift the notes left or right. By default, you can position notes only by quantization values defined by the **Time Correct** value (learn about this feature in [Operation > General Features > Timing Correct \(TC\)](#)).

**To move the selected notes without restricting** (“snapping”) **them to the quantization grid**, tap and hold **Don't Snap** in the lower-left corner of the screen, and then use the **data dial** or **-/+** buttons to shift the notes. In this case, each nudge is equivalent to four ticks.

**To adjust the start point or end point of the selected notes** (without changing their position), tap **Edit Start** or **Edit End** at the bottom of the screen, and then use the **data dial** or **-/+** buttons.

**To transpose the selected notes up or down**, tap **Transpose** at the bottom of the screen, and then use the **data dial** or **-/+** buttons.

**To switch to the previous or next track**, tap the **Track** field in the upper-left corner, and then use the **data dial** or **-/+** buttons.

**To mute or solo the track**, press and hold **Shift**, and then tap **Mute** or **Solo** (respectively) at the bottom of the screen.

**To open the Timing Correct window**, press and hold **Shift**, and then tap **TC** at the bottom of the screen. See [Operation > General Features > Timing Correct \(TC\)](#) to learn about this.

**To adjust the velocity of the selected notes**, tap **Velocity** at the bottom of the screen, and then use the **data dial** or **-/+** buttons. The numeric value will appear on the screen.

**To show or hide the velocity lane**, tap the **up arrow** (∧) button in the lower-right corner of the screen to show the velocity lane below the grid. Each note's velocity is represented by a vertical bar. The higher and redder the bar is, the higher the velocity is.

Tap the **up arrow** (∧) button once more to show a taller version of the velocity lane after which it will turn into a **down arrow** (∨) button, which you can then tap to hide the velocity lane.



## Making Basic Sound Edits

Let's make sure the samples are properly tuned and have good levels.

Press **Menu**, and then tap **Program Edit** to enter Program Edit Mode. Alternatively, press **Prog Edit** (MPC X, MPC One), or **Edit** (MPC Key 61, MPC Key 37).

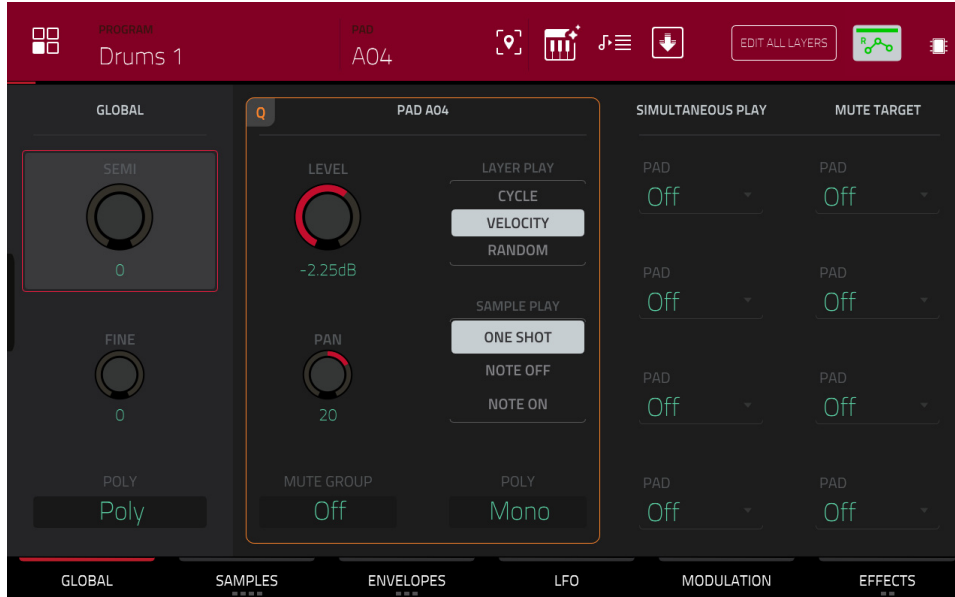

Press a pad to show its parameters on the screen.

**To adjust its volume**, tap and drag the **Level** knob up or down. Alternatively, use the **data dial** or **-/+** buttons. **To make finer adjustments**, double-tap the knob and adjust the larger version that appears. Tap anywhere else to return to the previous screen.

**To adjust its stereo panning**, tap and drag the **Pan** knob up or down. Alternatively, use the **data dial** or **-/+** buttons. **To make finer adjustments**, double-tap the knob and adjust the larger version that appears. Tap anywhere else to return to the previous screen.

Adjust the level of each pad to suit your taste. We recommend spreading the panning of the bright sounds (e.g., cymbals, snare drum) a little. Additionally, you can tune the kick drum sound—tap the **Samples** tab so the second square under it is lit, and then adjust the **Semi** and **Fine** knobs next to the sample name.

The snare drum may need some reverb to give it a more spatial sound.

Tap **Effects** at bottom of the screen so the first square under it is lit to view the **Insert Effects** tab. Press the **pad** with your snare drum sound to select it.

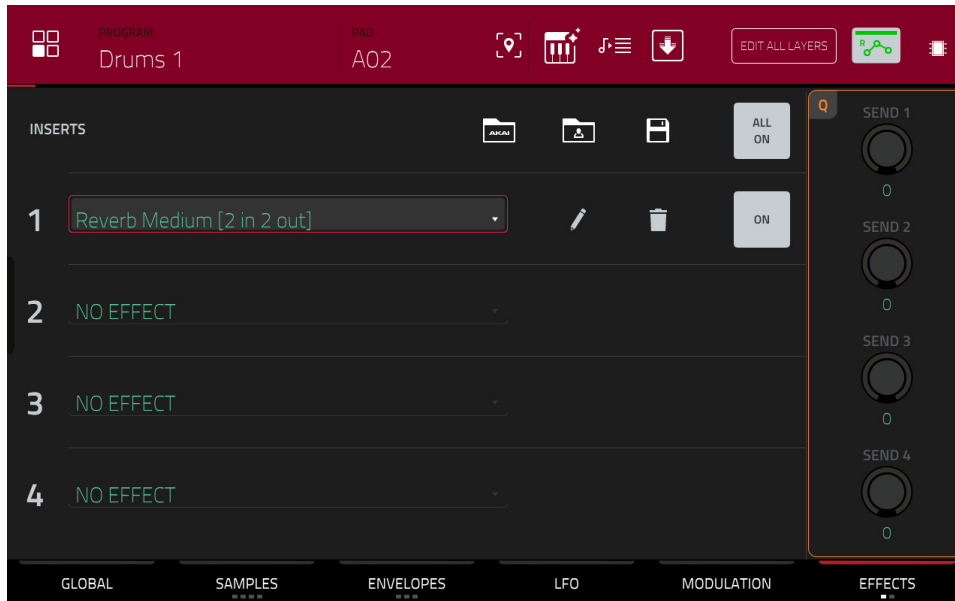

#### To add an effect:

1. Double-tap the desired slot. A list of effects will appear.
2. Swipe up or down to move through the list.
3. **To load an effect**, double-tap it. Alternatively, tap it once and then tap **Select** or push the **data dial**. Let's try **Reverb Medium**.
4. **To close the list**, tap **Close**.

**To adjust the effect's parameters**, tap the **pencil icon**.

**To empty the effect slot**, tap the **trash can icon**. Switch the effect on or off by tapping the **On/Off** button for the slot.

## Creating a Bass Track

Let's try recording a bass line. Unlike a drum kit, it's important to be able to play and record a bass sound chromatically, so this will be slightly different than setting up the drum kit.

Adding a bass line over the drum part means we need to work on a new track. A **track** is simply a layer of a sequence. Each track uses a program within your project. You can work with multiple tracks in a single sequence (e.g., a drum track, a bass track, a piano track, etc.). When you play the sequence, all of them will play simultaneously.

First, let's make an empty track.

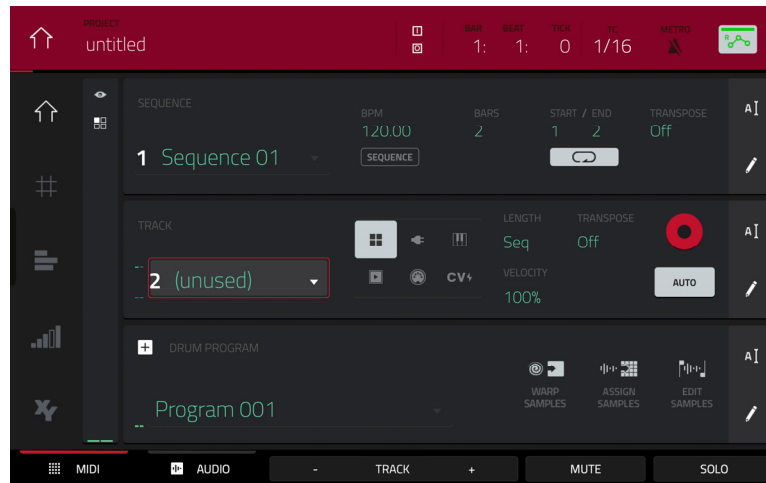

### To select a new track:

1. Press **Main** to go back to Main Mode.
2. Double-tap the **Track** field in the center-left part of the screen, and then tap **Track 2 (unused)** in the list of tracks that appears.

Alternatively, tap the **Track +** button at the bottom of the screen until **(unused)** appears in the **Track** field.

Let's create a new program for this track to use.

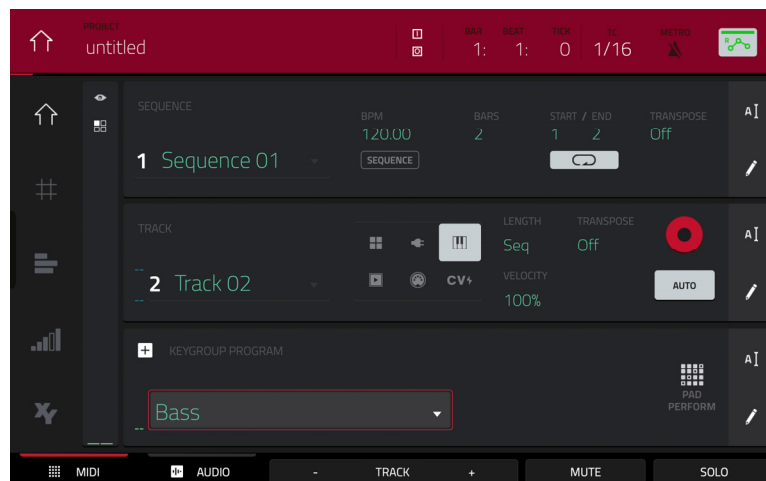

### To create a new program:

1. In the **Track** section in the middle of the screen, tap the **piano-keys icon**. This icon indicates a keygroup program, which is necessary to play the bass sound chromatically with the pads.  
A name for the new keygroup program will appear in the **Program** field in the lower part of the screen.
2. In the **Program** section in the lower part of the screen, tap the **cursor icon** on the right edge.
3. Use the virtual keyboard that appears to enter a new name, and then tap **Do It**.

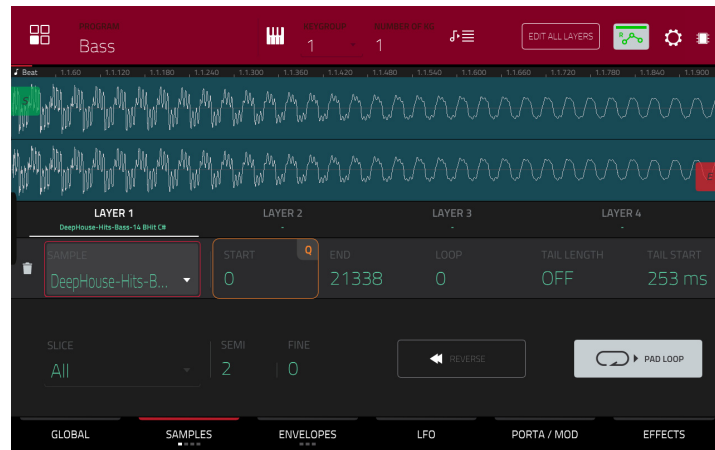

### To load and edit a bass sound:

1. Press **Browse** (MPC X, MPC One, MPC Studio), **Shift+Menu/Browse** (MPC Live, MPC Live II, MPC Key 61, MPC Touch), or **Load** (MPC Key 37) to show the Browser. Then, use the touchscreen to navigate to where your bass sounds are located, and load one to the project's sample pool. (You can look at [this earlier section](#) if you forgot how to do this!)
2. After loading a bass sample to the sample pool, **don't** use the Sample Assign tab like you did when creating a drum program; keygroup programs are different. Instead, press **Menu**, and then tap **Program Edit** to enter Program Edit Mode. Alternatively, press **Prog Edit** (MPC X, MPC One), or **Edit** (MPC Key 61, MPC Key 37).
3. In Program Edit Mode, tap the **Samples** tab at the bottom of the screen to show the four layers of samples in the program.
4. Double-tap the first **Layer** field and then tap your bass sample in the list on the left. Because you're working with a keygroup program instead of a drum program, this sample is now playable across **all** pads.

**Tip:** On your MPC hardware, disable Pad Perform and then press the **Pad Bank D** button to switch to Pad Bank D and press **Pad 13**. You should hear the bass sample played back with its original pitch. You can use the other pads to play your sample chromatically. Alternatively, you can play middle-C on an external MIDI device to hear the sample at the original pitch.

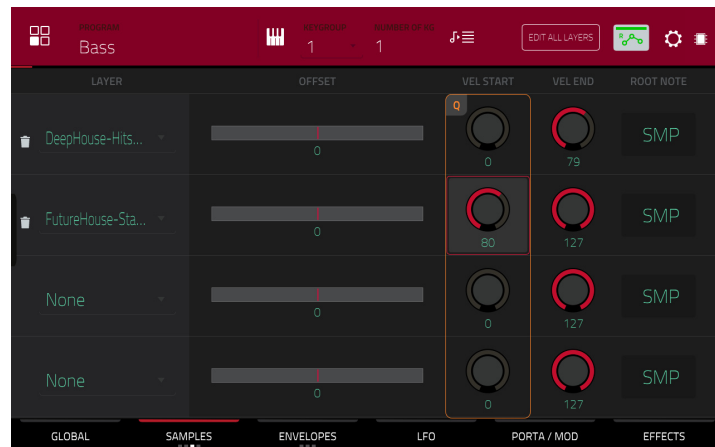

Let's add a second layer and set the layers' velocity ranges so the bass will sound different when played at a higher velocity (as a real bass would):

1. Press **Browse** (MPC X, MPC One, MPC Studio), **Shift+Menu/Browse** (MPC Live, MPC Live II, MPC Key 61, MPC Touch), or **Load** (MPC Key 37) to show the Browser, select a different bass sample that sounds similar but a little bit brighter, and load it to the project's sample pool.
2. Return to Program Edit Mode, and in the **Layer** tab, double-tap the second **Layer** field, and select the new bass sample. Press a **pad** to hear both samples will sound at once. Maybe this new sound is interesting as it is, but let's make some quick edits to get as close as we can to a real-life bass sound.
3. Tap the **Pan Velocity** tab to show its parameters.
4. Tap **Layer 1's Vel End** knob and turn the **data dial** to set it to **80**. Do the same to set **Layer 2's Vel Start** slider to **81**. Now when you press a pad, the lower velocities (0–80) will trigger the Layer 1 sample only, while higher velocities (81–127) will trigger the Layer 2 sample only.

Let's record that bass line now. Prepare your recording as described earlier, and record some bass notes. You can edit your recording just like we've done earlier.

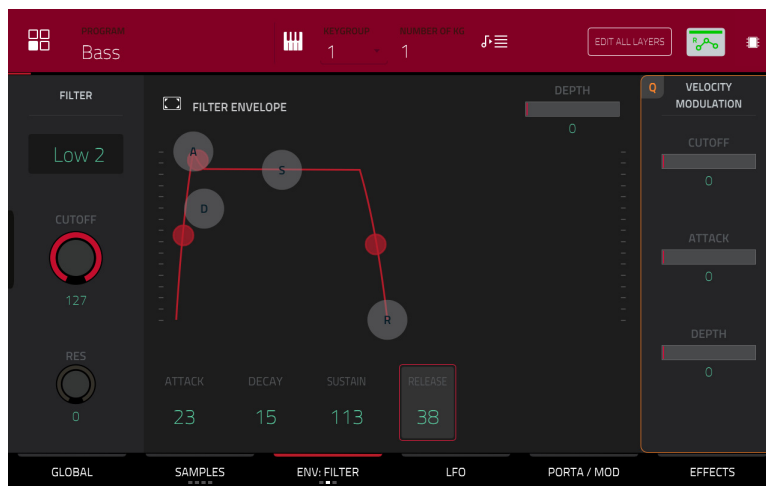
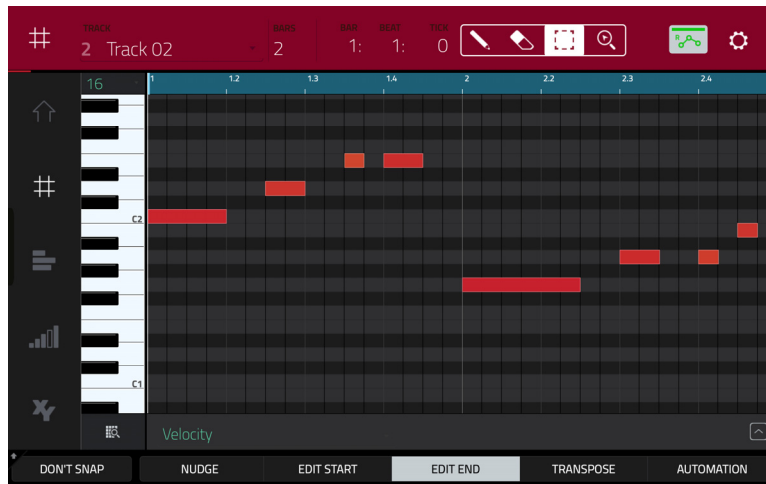

Once you've recorded it, let's tweak the sound a bit in the **Filter** section:

1. In Program Edit Mode, tap the **Filter/Env** tab to show its parameters.
2. Double-tap the **Type** drop-down menu, and select a filter. Let's try working with **Lowpass 2 Pole**.
3. Tap the **Cutoff** or **Reso** (resonance) knob, and turn the **data dial** to adjust their settings until your bass sample sounds good to you.
4. In the **Amp Envelope** section, tap the **Attack** or **Release** knob, and turn the **data dial** to adjust their settings. These control the overall level characteristics of the sound.

Do you want to add an effect? Do this in the **Effects** tab:

1. Tap the **Effects** tab to show the insert effects.
2. Double-tap one of the **Inserts** slots to show a list of available effects.
3. Double-tap the effect you want to add to your bass line, or click **Close** to cancel.

**To adjust the settings of the effect**, click the **pencil icon** next to its slot to open a window that shows its parameters.

**To activate or deactivate all insert effects for that program**, click the **All On/All Off** button in the upper-right corner.

So far, we've created a simple drum sequence and a bass line to go with it. Repeat this process to create a second sequence.

## Recording an Audio Track

We've already created some MIDI tracks, so let's record some actual audio for our next track:

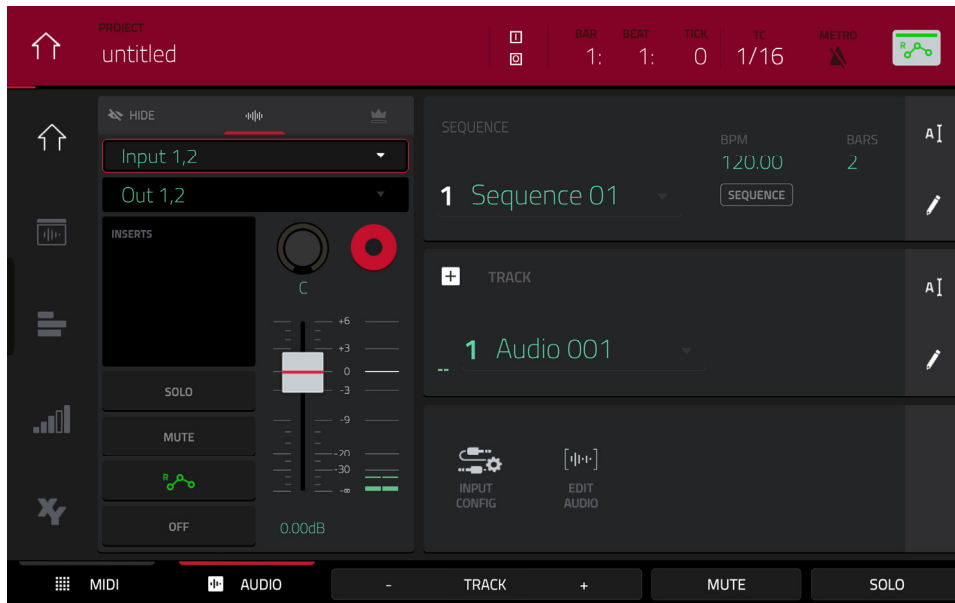

1. Press **Main** to go back to Main Mode.
2. Tap the **Audio** tab at the bottom of the screen. **Audio 001** will appear in the **Track** field.
3. If the channel strip is not already shown on the left side of the screen, tap **Input Config** (in the lower part of the screen) or the small **eye icon** (in the upper-left part of the screen) to show it.
4. Connect a synthesizer or other line-level audio source to the 1/4" (6.35 mm) **input/inputs** on your MPC hardware's rear panel, and set the **Line/Phono** selector to **Line** (MPC X, MPC Live, MPC Live II), or set the **Inst/Line** selector to **Line** (MPC Key 61).
5. Double-tap the first field (**Input \_\_**) and select **Input 1** or **Input 1,2** (depending on your audio source) as the input source.
6. If the second field is not set to **Out 1,2**, double-tap it and select that option as the output.
7. Tap the **Monitor** button to cycle through its three states until it reads **Auto** (you will hear incoming audio while the track is record-enabled only).
8. Turn the **3/4 Rec Gain** (MPC X), **Rec Vol** (MPC Live, MPC Live II, MPC One, MPC Key 37, MPC Touch), or **Gain** (MPC Key 61) knob to set the input level while playing your audio source. You should now see the level in the meter. Make sure it does not exceed the maximum level (the meter should not be "peaking" constantly).
9. If **Solo** and **Mute** are on, tap or press them so they are **off**. Also, tap the **automation button** so it is **off/gray** (not **green/Read [R]** or **red/Write [W]**). Alternatively, press **Read/Write** (MPC X), **Shift+Automation Read/Write** (MPC Key 61), or **Shift+Automation** (MPC Key 37).
10. Tap the **Record Arm** button to record-enable the track. Alternatively, press **Rec Arm** (MPC X).
11. Press **Rec** to record-arm the sequence.
12. **To start recording**, press **Play** or **Play Start**—then play your audio source! You should hear your existing sequence playing in the background.  
**To stop recording**, press **Stop**.

Record another audio track for your other sequence: Select the other sequence in Main Mode, and create another audio track (**Audio 002**) to go with that sequence.

## Creating a Song

This section explains how to make a song out of your sequences. Before starting, make sure that you have recorded some sequences (which we described [earlier](#)).

**To enter Song Mode**, make sure playback is stopped, and then press **Menu**, and then tap **Song** to enter Song Mode. Alternatively, press **Song** (MPC X).

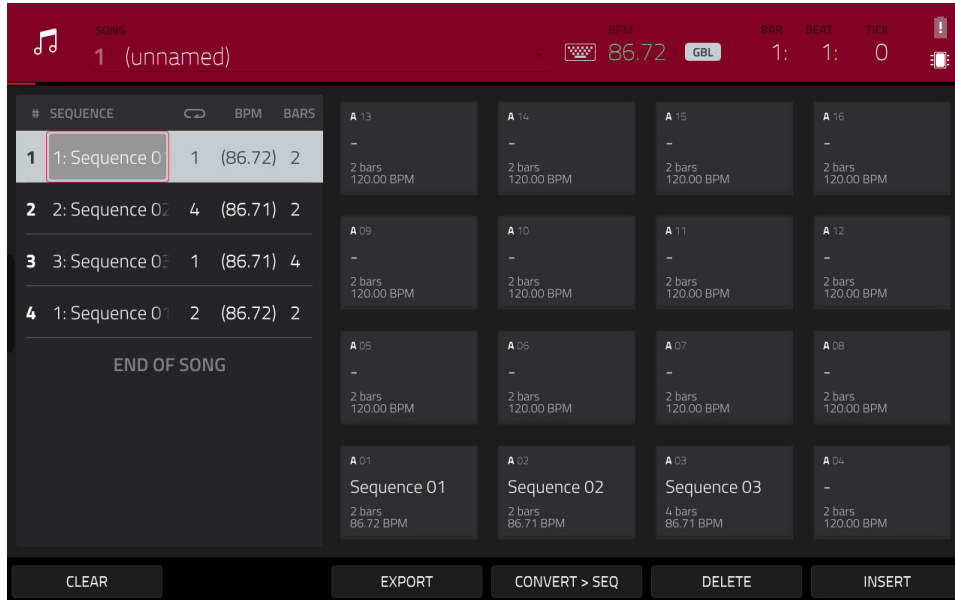

In Song Mode, each of the sequences you've created in this project assigned to a pad. The sequence playlist is to the left of the pads, showing the song's structure.

As a song plays, it moves through each step of the sequence playlist. Each step contains a sequence you assigned. Each step can be repeated, determined by the value in the **Repeat** column (the **repeat icon**; a value of **1** means the sequence will play through only once). The **Bars** column on the right indicates the length of that sequence.

Each step can be set to play its sequence at an independent tempo, determined by the value in the **BPM** column.

**Important:** Each sequence has its own tempo, while the project itself may use a different global tempo. The BPM value for each sequence may be different from the global tempo. As long as playback is set to follow the global tempo, each sequence's individual tempo will be ignored. By default, each project is set to use the sequence tempo, which you set back in the [Creating a Drum Sequence](#) chapter. We recommend tapping the **SEQ/GBL** button at the top of the screen (so the button displays **GBL**) and entering a global tempo to ensure all sequences use the same tempo.

**To insert a step at the current position**, tap **Insert**.

**To delete the currently selected step**, tap **Delete**.

**To set which sequence plays for a step**, tap the step's **Sequence** field, and then turn the **data dial** to select a sequence.

**To set how many times a sequence repeats**, tap the step's **Repeat** field (next to the sequence name), and then turn the **data dial** to select a number.

## Exporting the Song

Want to share your new song? Just export it first.

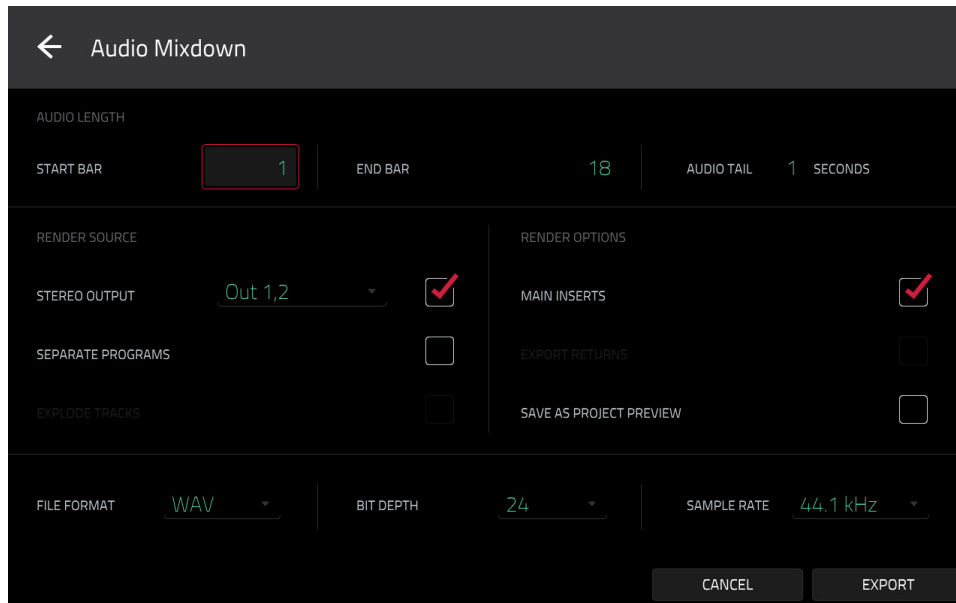

### To export a song:

1. While in Song Mode, tap **Export** at the bottom of the screen.
2. In the **Audio Mixdown** screen that appears, do the following:
  - Make sure the **Start** field is set to **1**, and set the **End** field to the last bar of your song.
  - Tap the **Audio Tail** field and turn the **data dial** to set it to **2** seconds.
  - As you'll likely share the song online, tap the **mp3** file format option in the lower-left corner.
3. Tap **Export**. Choose where you want to save the song.

**To name the song**, tap the **File Name** field, and use the virtual keyboard that appears to enter a new name, and then tap **Save** to start exporting.



## Other Features Explained

This chapter describes various advanced features. For a fuller explanation of these features, please refer to their corresponding sections in the [Operation](#) chapter.

### Step Sequencer

You've already learned how to record note events on a track, but you can quickly enter note events in the Step Sequencer by using the pads as "step buttons," simulating the experience of a traditional step-sequencer-style drum machine.

**To enter the Step Sequencer**, press **Menu**, and then tap **Step Sequencer**. Alternatively, in some modes, you can tap the **steps icon** on the left edge of the screen. You can also press **Step Seq** (MPC X, MPC Live II, MPC One), or **Shift+Grid/Step Seq** (MPC Key 61, MPC Key 37).

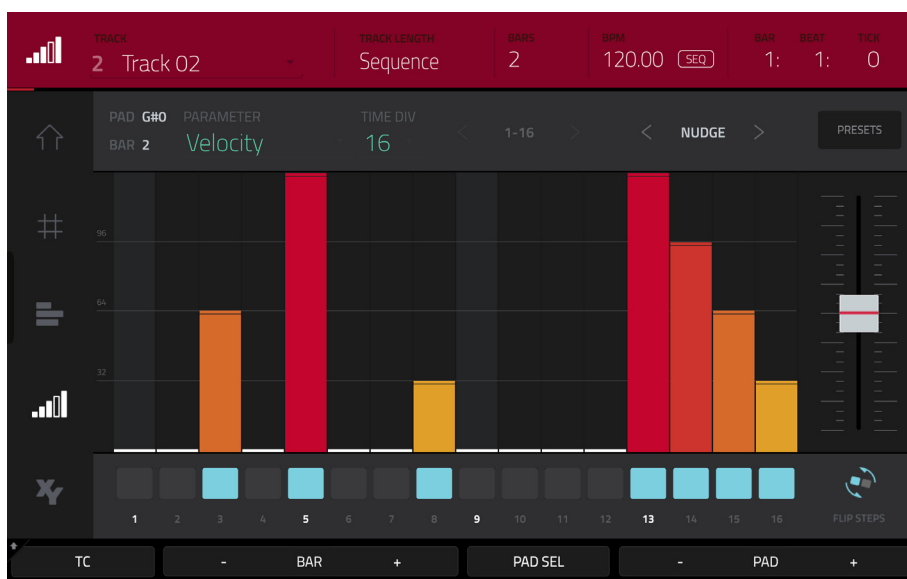

1. Let's create a sequence on a new track. Tap the **Track** field in the upper-left corner, and then use the **data dial** or **-/+** buttons to select an (**unused**) track. Alternatively, double-tap the **Track** field, and then tap a track to select it.
2. Tap the **Track Length** field at the top of the screen to set a length for the track, and then use the **data dial** or the **-/+** buttons to select a length. If you select the minimum value, **Sequence**, the track will be however long your sequence is.

**Tip:** This lets you maintain tracks of different lengths. For instance, you could play a 1-bar drum sequence repeatedly under a 4-bar bass line.

3. Tap the **Bar** **-/+** buttons at the bottom of the screen to select the bar whose steps you want to create or edit. The bar number will appear in the **Bar** field in the upper-left corner.
4. Tap the **Pad** **-/+** buttons at the bottom of the screen to select the pad whose steps you want to create or edit. The pad number will appear in the **Pad** field in the upper-left corner.
5. Press **Play** to start your sequence.
6. Each pad represents a step in the bar. If the pad already has note events on the selected track, the corresponding pads (steps) will be lit with colors corresponding to their velocities.

**To enter a note at a step**, press an **unlit pad**. The pad will light up with a color corresponding to its velocity.

**To delete the note from a step**, press a **lit pad**. The pad will become unlit.

**To delete all notes from the entire bar**, press and hold **Shift**, and then tap **Clear Bar** in the lower-right corner.

See [Operation > Modes > Step Sequencer](#) to learn more about this feature.

## Drum Loops & Chop Mode

Modern music producers often use drum loops to add grit and nuance to programmed beats. This section explains how to use Sample Edit Mode to work with drum loops.

Use the Browser to locate a drum loop, and then double-tap it to add it to the current program. The loop does not have to match the tempo of anything in the project.

**To enter Sample Edit Mode**, press **Menu**, and then tap **Sample Edit** to enter Sample Edit Mode. Alternatively, press **Sample Edit** (MPC X, MPC One, MPC Key 61, MPC Key 37), or **Shift+Mute/Sample Edit** (MPC Live II).

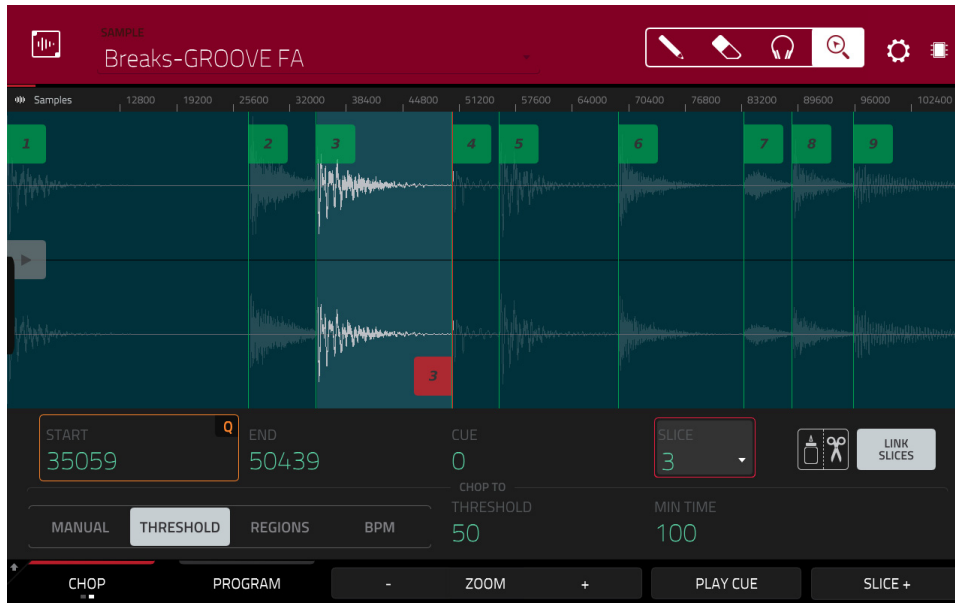

1. Tap the **Sample** field at the top of the screen, and then use the **data dial** or **-/+** buttons to select the loaded drum loop. You can scroll through all loaded samples in the project. Alternatively, double-tap the **Sample** field, and then tap a sample to select it.
2. Tap the **Trim/Chop** tab in the lower-left corner to switch between Trim Mode and Chop Mode. Select Chop Mode, which will let us cut the drum loop into slices.
3. Tap **Threshold**, and then tap the **Threshold** field to the right of it. Use the **data dial**, **-/+** buttons, or **numeric keypad** (MPC X) to select a value. Alternatively, double-tap the **Threshold** field and use the numeric keypad on the screen. The lower the threshold, the more slices will be created. Be sure to select a value so that every transient peak of the drum loop has a corresponding slice marker.

**Tip:** Each slice will be automatically assigned to a pad: **Pad A01** plays Slice 1, **Pad A02** plays Slice 2, etc. Press each pad to play the slice with the same number.

Let's use this chopped sample to create a new program in which each of these slices is an individual sample. We can also automatically create corresponding note events to play back these slices sequentially.

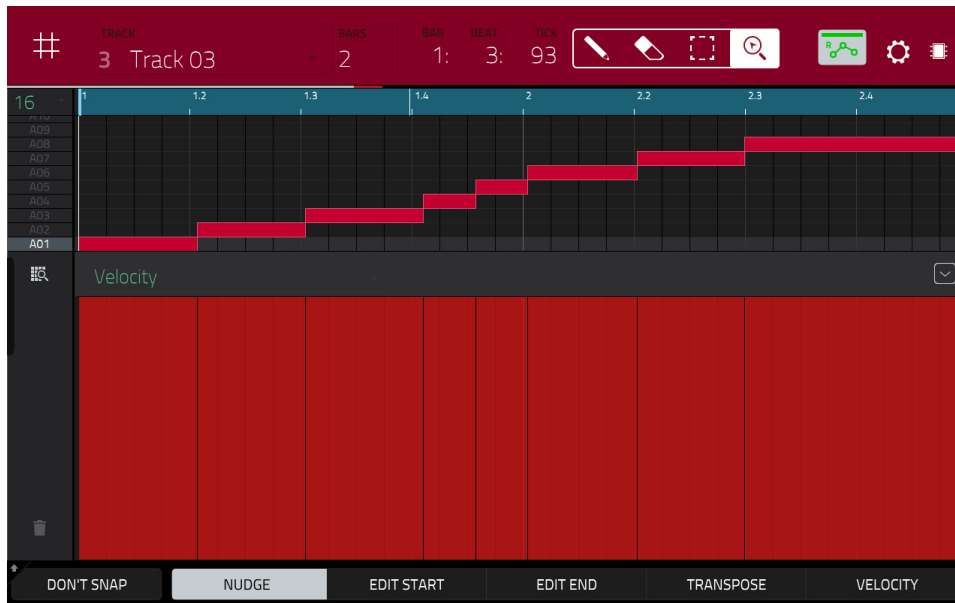

1. Press and hold **Shift** and then tap **Convert** at the bottom of the screen to enter the **Convert or Assign Slices** window.
2. Tap the **Convert To** field, and then use the **data dial** or **-/+** buttons to select **New Program with New Samples**.
3. Make sure **Crop Samples** is checked. If it is not, tap it.
4. Make sure **Create New Program** is checked. If it is not, tap it.
5. Make sure **Create Events** is checked. If it is not, tap it.
6. Tap the **Bars** field, and then use the **data dial** or **-/+** buttons to select how many bars the entire sample should use in your program.
7. Tap **Do It** to proceed. Each slice will be assigned to a pad, and each pad will have a recorded note event in the track. When you play that track, it will play each pad (each slice) in the original order. Press **Menu** and then tap **Grid View** to see how the sample appears in your sequence.
8. Press **Play** and listen to how the drum loop matches your song tempo now.

You can also edit the note events of the drum loop slices—enter Main Mode to do this. A new track with the note events playing their corresponding slices has been automatically created. Tap the **TC/clock icon** at the top of the screen to use the **Timing Correct** window to quantize the note events so they fall on exact, even time intervals.

You can also rearrange the note events, thus creating a new playback order for the slices. You can also edit each slice or sample in Program Edit Mode. You can add effects for slices or use the filter function to change the frequency range of a selected slice. There are almost no limits to what you can do.

See [Operation > Modes > Sample Edit Mode > Chop Mode](#) to learn more about this feature.

## Pad Muting & Track Muting

Pad Mute Mode and Track Mute Mode let you silence different pads and tracks to see what the sequence sounds like without those samples or parts.

To enter **Pad Mute Mode**, press **Menu**, and then tap **Pad Mute** to enter Pad Mute Mode. Alternatively, press **Shift+Track Mute/Pad Mute** (MPC X, MPC One, MPC Key 37), or **Shift+Mute/Pad** (MPC Key 61).

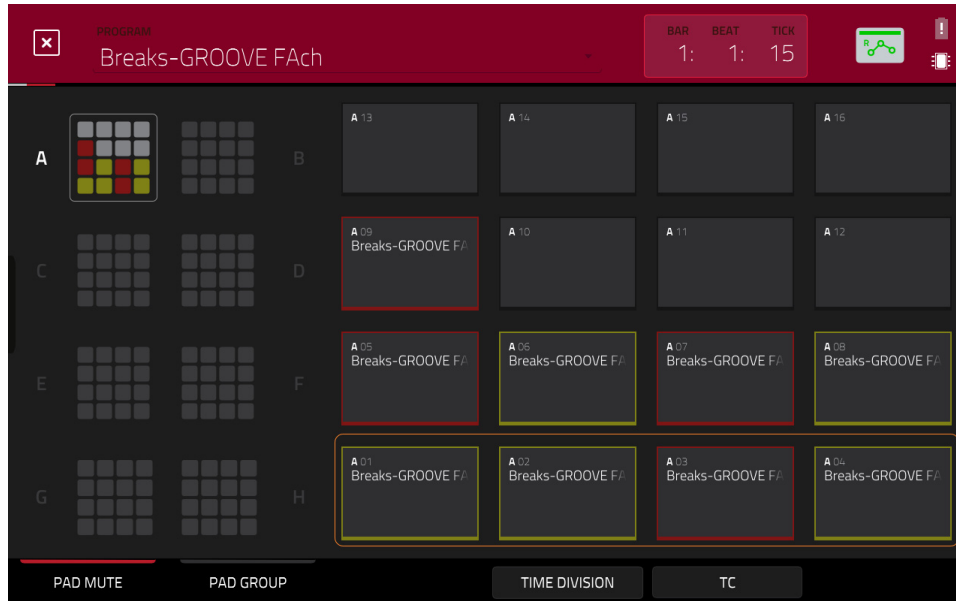

1. Press **Play** to play the sequence.
2. Tap the **Program** field at the top of the screen, and then use the **data dial** or **-/+** buttons to select your drum program. Alternatively, double-tap the **Program** field, and then tap a program to select it.
3. Mute a pad by pressing it once or tapping it on the screen. The muted pad will be lit **red**. You can mute multiple pads at the same time.

See [Operation > Modes > Pad Mute Mode](#) to learn more about track mutes.

You can also mute entire tracks by using the similar Track Mute function.

**To enter Track Mute Mode**, press **Menu**, and then tap **Track Mute** to enter Track Mute Mode. Alternatively, press **Track Mute** (MPC X, MPC One, MPC Key 37), or **Mute** (MPC Key 61).

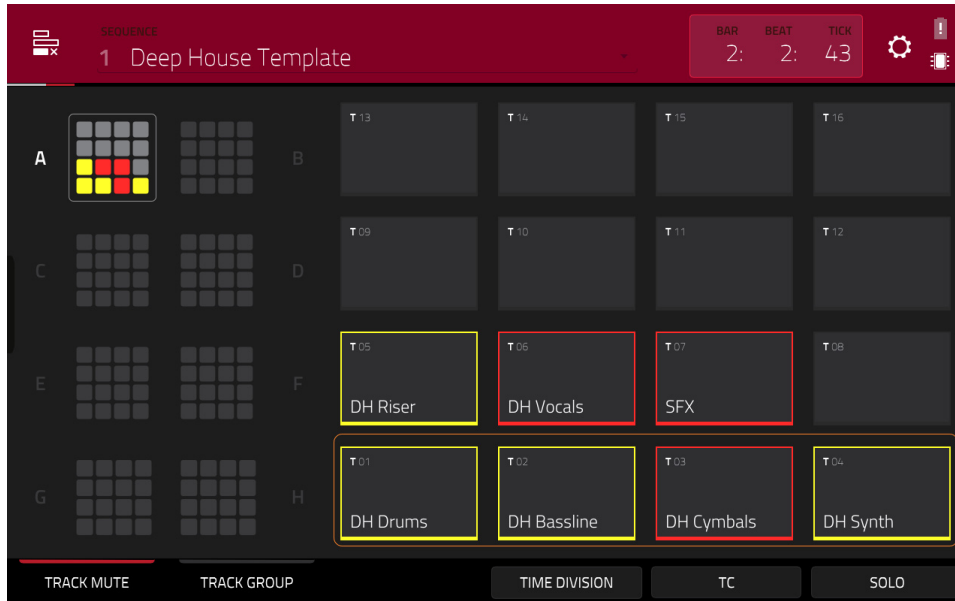

1. Press **Play** to play the sequence.
2. Tap the **Sequence** field at the top of the screen, and then use the **data dial** or **-/+** buttons to select the desired sequence. Alternatively, double-tap the **Sequence** field, and then tap a sequence to select it.
3. Each pad is assigned to a track. Mute a track by pressing the corresponding pad or tapping it on the screen. The pad will be lit **red**. You can mute multiple tracks at the same time.

**Tip: To mute a track only at precise note intervals** (“quantizing” your mutes, essentially), tap **Time Division** to set a musical timing value. Tap the desired musical value (e.g., **1 Bar**). Alternatively, use the **data dial** or **-/+** buttons. Tap **Close** to close the page. Now, when you press a pad in Track Mute Mode, the mute will occur precisely at the beginning of the following time division (in this example, one bar). This lets you test musical combinations of patterns—the preliminary stage to building a song structure.

See [Operation > Modes > Track Mute Mode](#) to learn more about track mutes.

## Sampling (Recording)

This section describes recording new samples of your own, which you can use in your projects.

**Important:** To record any audio, you need to connect an audio source to your MPC hardware or to your computer's audio interface.

**To open the Sampler**, press **Menu**, and then tap **Sampler** to enter Sampler Mode. Alternatively, press **Sampler** (MPC X, MPC One), press **Shift+Mix/Sampler** (MPC Live II), or press **Shift+Sample Edit/Sampler** (MPC Key 61, MPC Key 37).

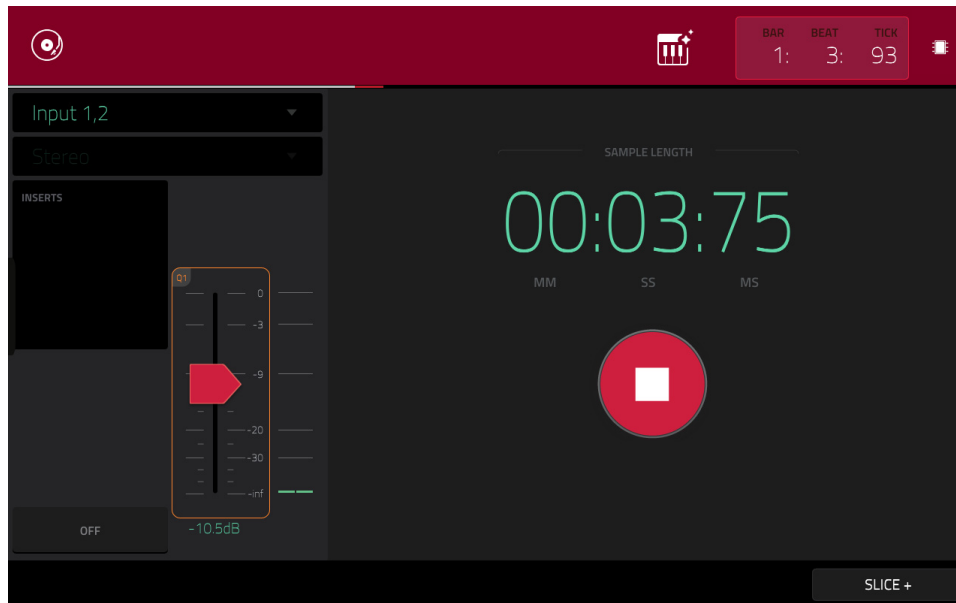

1. Connect an audio source to the input/inputs of your MPC hardware.
2. The **Input** \_\_\_ menu in the upper-left corner should be set to **Input 1,2** (the inputs of your MPC hardware). If it is not, then select **Input 1,2**.
3. Turn the **3/4 Rec Gain** (MPC X), **Rec Vol** (MPC Live, MPC Live II, MPC One, MPC Key 37, MPC Touch), or **Gain** (MPC Key 61) knob to set the input level while playing your audio source. You should now see the level in the meter. Make sure it does not exceed the maximum level (the meter should not be “peaking” constantly).
4. Tap and drag **threshold slider** to set the threshold. Alternatively, use the **data dial** or **-/+** buttons. Set it to a fairly low level (e.g., **-50 dB**).
5. Tap **Arm** to record-arm the Sampler.
6. Play your audio source. The Sampler will start recording immediately when the input level reaches the threshold value. Alternatively, tap the round **Record** button to manually start recording.
7. **To stop recording**, tap the round **Stop** button. The **Keep or Discard Sample** window will appear.

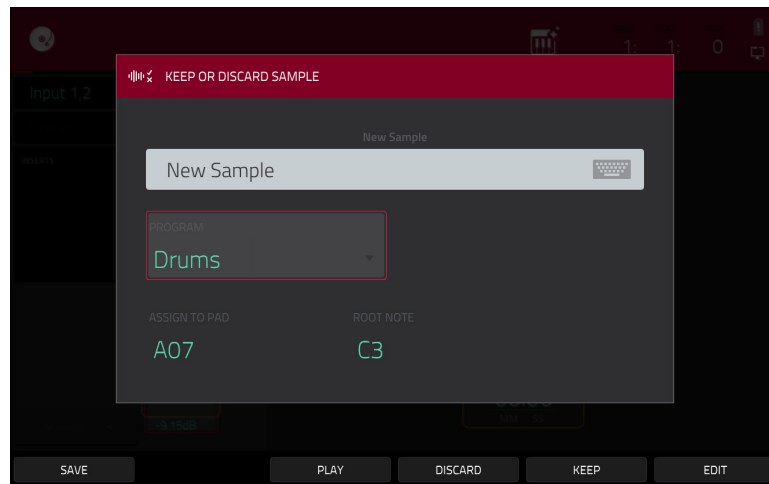

In the **Keep or Discard Sample** window:

**To name the new sample**, tap the **Edit Name** field and use the virtual keyboard to enter a name.

**To assign the new sample to a program**, tap the **Program** field, and then use the **data dial** or **-/+** buttons to select the desired program. Alternatively, double-tap the **Program** field, and then tap a program to select it.

**To assign the sample to a pad in the program**, tap the **Assign to Pad** field, and then press the desired **pad**. Alternatively, use the **data dial** or **-/+** buttons to select the desired pad number, or double-tap the **Pad** field, and then tap a pad number.

**To set the Root Note for the sample**, tap the **Root Note** field, and then use the **data dial** or **-/+** buttons to select the desired note.

**To save the sample**, tap the **Save** button at the bottom of the screen.

**To play the recording**, tap the **Play** button at the bottom of the screen.

**To discard the recording and return to the previous screen**, tap the **Discard** button at the bottom of the screen.

**To confirm your selections**, tap **Keep** at the bottom of the screen.

**To edit the sample in Sample Edit Mode**, tap the **Edit** button at the bottom of the screen.

See [Operation > Modes > Sampler](#) to learn more about this feature.

## Sample Editing

You may need to edit your newly recorded samples using Sample Edit Mode.

**To enter Sample Edit Mode**, press **Menu**, and then tap **Sample Edit** to enter Sample Edit Mode. Alternatively, press **Sample Edit** (MPC X, MPC One, MPC Key 61, MPC Key 37), or press **Shift+Mute/Sample Edit** (MPC Live II).



In Sample Edit Mode:

**To switch between Trim Mode and Chop Mode**, tap the **Trim/Chop** tab at the bottom of the screen. In this example, use **Trim Mode**.

**To set the sample's start point**, use the **first** column of **Q-Link knobs** (when in the **Screen Q-Link Edit Mode**) to adjust the start point with varying degrees of resolution. Alternatively, tap and drag the **S** marker in the waveform. You can also double-tap the **Start** field and use the numeric keypad on the screen to enter a value (or tap the **Start** field and use the **numeric keypad**).

**To set the sample's end point**, use the **second** column of **Q-Link knobs** (when in the **Screen Q-Link Edit Mode**) to adjust the end point with varying degrees of resolution. Alternatively, tap and drag the **E** marker in the waveform. You can also double-tap the **Start** field and use the numeric keypad on the screen to enter a value (or tap the **Start** field and use the **numeric keypad**).

**To hear your edits**, press **Pad 10** to play the sample from the start point to the end point.



Let's apply some processing to the sample.

To open the **Process Sample** window, tap **Process** at the bottom of the screen.

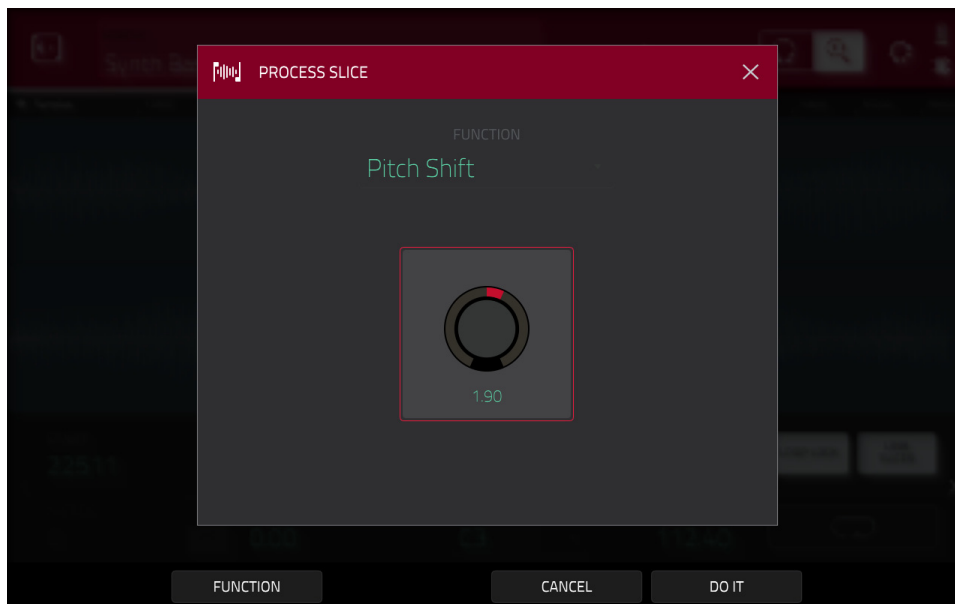

1. Use the **data dial** or **-/+** buttons to select the desired process in the **Function** field. Alternatively, tap **Function** or double-tap the **Function** field, and then tap the desired process. Let's select **Pitch Shift** to change the overall pitch of your sample. This will transpose the sample without affecting its length.
2. **To set the pitch shift amount**, tap and drag the **knob** in the center of the window up or down. Alternatively, use the **data dial** or **-/+** buttons.  
**To make finer adjustments**, double-tap the **knob** and adjust the larger version that appears. Tap anywhere else to return to the previous screen.
3. **To confirm your selections**, tap **Do It**.  
**To cancel the process**, tap **Cancel**.

See [Operation > Modes > Sample Edit Mode](#) to learn more.

## Recording Automation with the XY Pad

Automating various parameters is a good way to add some motion and dynamism to your sequences.

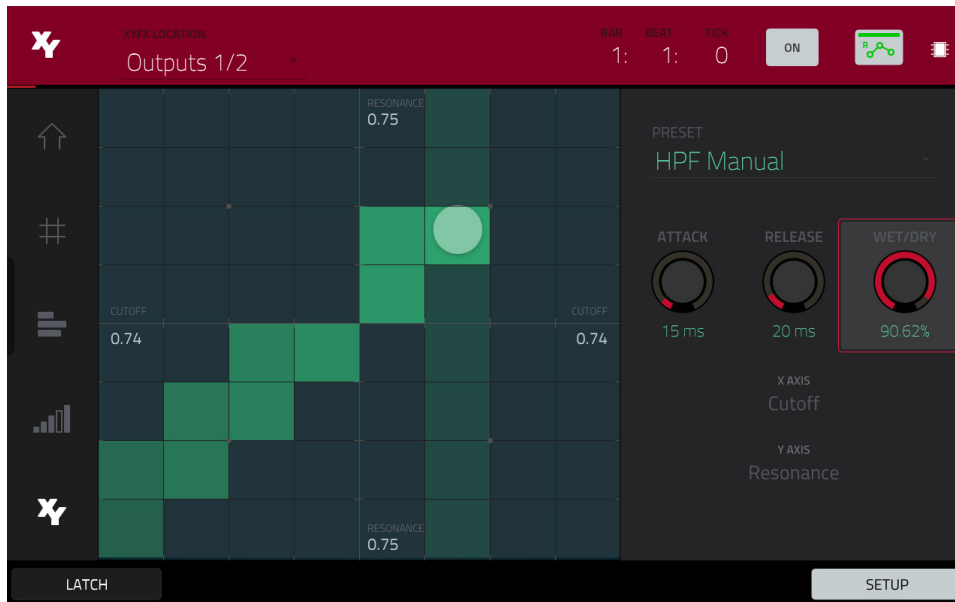

1. Press **Menu**, and then tap **XYFX** to enter XYFX Mode. Alternatively, press **XYFX** (MPC X), press **Shift+Next Seq/XYFX** (MPC Live II, MPC One), or press **Shift+Edit/XYFX** (MPC Key 61, MPC Key 37).
2. Double-tap the **XYFX Location** field, and select **Program**.
3. When you first enter this mode in a project, you will be prompted to “load” XYFX to the program. Tap **Insert XYFX** to do this.
4. Tap **Setup** to show the Setup panel, which controls how the XY pad behaves.
5. Double-tap the **Preset** field, and tap an effect to select it. (These are just the effects available in XYFX Mode, not all MPC effects.) Swipe up or down to view the entire list.
6. Tap and drag any of the knobs (**Attack**, **Release**, or **Wet/Dry**) up or down to set their values as desired. Below them, you can see what parameter the X axis and Y axis control.

**Note:** XYFX uses an envelope to control how quickly the effect crossfades between the dry signal and wet signal. The **Attack** knob determines how long it takes the completely dry signal to reach the wet signal (determined by the **Wet/Dry** knob) after you touch the XY pad. The **Release** knob determines how long it takes the wet signal (determined by the **Wet/Dry** knob) to return to the completely dry signal after you touch the XY pad.

7. Tap the **automation button** to cycle through the available automation modes; alternatively, press **Read/Write** (MPC X, MPC Key 61) or **Automation** (MPC Key 37). Make sure the button is **red** (the **Write (W)** option).
8. Press **Play Start** to start recording.
9. As you record, move your finger over the **XY pad** on the screen. The changes in the sound are being recorded as automation of both the X axis and Y axis parameters.

**Tip:** While touching the **XY pad**, tap **Latch** in the lower-left corner to keep the marker on the XY pad even after you release it. The marker will remain there until you touch another part of the XY pad or until you tap **Latch** again.

10. When you are done recording, press **Stop**.
11. Tap the **automation button** to select the **green Read (R)** option; alternatively, press **Read/Write** (MPC X, MPC Key 61) or **Automation** (MPC Key 37). This ensures your track uses the automation you just recorded when you play it back.

See [Operation > Modes > XYFX Mode](#) to learn more about using this feature.

## Using MPC as a Controller

If you are using the MPC software on your computer, you can switch MPC X/Live/Live II/One/Key 61/Key 37 into **Controller Mode**, allowing you to use it to control the software. MPC Studio and MPC Touch already operate as a controller only.

The MPC software offers the same features and functionality as the MPC hardware in Standalone Mode but with some notable differences, which are discussed in [Operation > General Features > Standalone vs. Controller Mode](#).

## Operation

This chapter explains the complete features and functions of your MPC hardware.

### Important:

- When accessing the secondary functions of buttons on your MPC hardware, you can do this one of two ways: (1) pressing and holding **Shift** and then pressing the desired button or (2) double-pressing the desired button. This manual describes these operations using only the first option, but both are acceptable.
- When the left-most button at the bottom of the screen shows an upward arrow (↑), it means there are additional buttons you can use when you press and hold **Shift**. Press and hold **Shift** to show the secondary buttons, and any of them, if desired. Release **Shift** to return to the previous buttons.
- Almost every mode shown on the screen has 1–6 buttons at the bottom. Each of these buttons select a different tab in that mode or perform a specific function in that mode.



**MPC X:** You can press the **F-Key** button to activate or deactivate the F-Key feature. When active, the six buttons under the touchscreen correspond to the options shown at its bottom edge. The F-Key button and those six buttons will be lit **red** when active. When inactive, the six buttons under the touchscreen will access their normal modes instead (**Menu, Browser, Step Seq, Sampler, XYFX, and Looper**).

- **MPC X:** As an alternative to tapping a control on the screen to select it, you can use the **cursor**s to navigate through the controls on the screen. The **center cursor** acts as an **Enter** key.

**MPC Live, MPC Live II, MPC One, MPC Key 61, MPC Key 37, MPC Touch:** As an alternative to double-tapping an item on the screen to “enter” it, you can press the **data dial**.

- When a parameter is highlighted and has a red outline, this means that it is selected. You can then change it by turning the hardware’s **data dial** or using the **-/+** buttons. If the parameter is a number, double-tap it to show a numeric keypad on the screen to enter a specific value, or use the **numeric keypad** (MPC X).
- **MPC Live, MPC Live II, MPC One, MPC Key 61, MPC Key 37, MPC Touch:** When the touchscreen shows a parameter or group of parameters with a **gold outline** (and sometimes a **Q** in the corner), this means that the current bank of **Q-Link knobs** will control those parameters or settings. Turn a **Q-Link knob** to adjust its corresponding parameter value or setting in that group. When the value has decimal places, you can sometimes press and hold **Shift** and then turn the **Q-Link knob** to adjust the value by smaller increments. You can also press the **Q-Link** button to select another group of four parameters.
- Press and hold the any of the **Q-Link** buttons (**Project, Program, Pad Scene, Pad Param, or Screen Control/Edit**: MPC X) or the **Q-Link** button (MPC Live, MPC Live II, MPC One, MPC Key 61, MPC Key 37, MPC Touch) to see an overview of all 16 **Q-Link knobs** and their parameters in the **QLinks** window that appears. You can then tap a column or row of knobs to select those four Q-Link knobs, and then release the **Q-Link** button. See [Modes > Q-Link Edit Mode](#) to learn more about using the Q-Link knobs throughout your project.
- **MPC Studio mk2:** This hardware functions as a controller for the MPC software. The controls are designed to give you quick access to important software functions such as: track/program/sequence select, track type, file browsing, sample editing, project parameters (Quantize, Timing Correct, Automation Read/Write) and more. As such, descriptions in this manual for touchscreen operation do not apply to MPC Studio. For more information on using the MPC software, consult the MPC software User Guide by going to **Help > MPC Help > MPC Software Manual**.
- **MPC X Special Edition:** Mentions of the features and functions of MPC X hardware throughout this guide also apply to the MPC X Special Edition unless otherwise noted.
- **MPC One+:** Mentions of the features and functions of MPC One hardware throughout this guide also apply to the MPC One+ unless otherwise noted.



## General Features

### Control Types

The MPC touchscreen uses the following types of control elements:

#### Knobs

To set the value for a knob, do any of the following:

- Tap and drag the knob up or down.
- Tap the knob to select it, and then use the **data dial** or **-/+** buttons to adjust the value.
- Double-tap the knob to show it in a larger screen. Alternatively, press the **data dial**, or the **center cursor** or **Enter** (MPC X), when the knob is selected.

Tap and drag the larger version that appears, or use the **data dial** or **-/+** buttons to adjust the value.

If the knob is bipolar (has positive and negative values with the center as the default position), double-tap the larger version to reset it to the center/0 position.

Tap anywhere else to return to the previous screen.

- Press and hold **Shift** while turning the **data dial** to adjust a value by smaller increments.

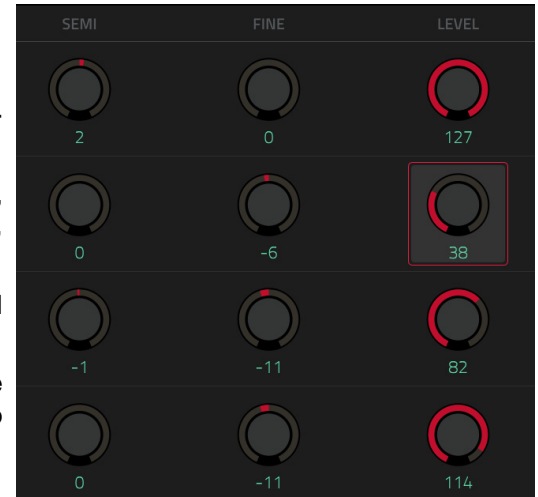

#### Parameter Values

To set the value for a parameter, do either of the following:

- Tap the field to select it, and then use the **data dial** or **-/+** buttons to adjust the value.  
When the value has decimal places, you can sometimes press and hold **Shift** and then use the **data dial** or **-/+** buttons to adjust the value by smaller increments.
- Double-tap the field or hold your finger on it for a second. In the screen that appears, use the **numeric keypad**, the **data dial**, or the **-/+** buttons to adjust the value. Alternatively, tap and drag the value up or down.

You can also tap **/2** to halve the value or **x2** to double it.

To confirm the value and remain on this screen, tap **Apply**.

To confirm the value and return to the previous screen, tap **Do It**.

To return to the previous screen without changing anything, tap the gray area in the upper-left corner of the screen.

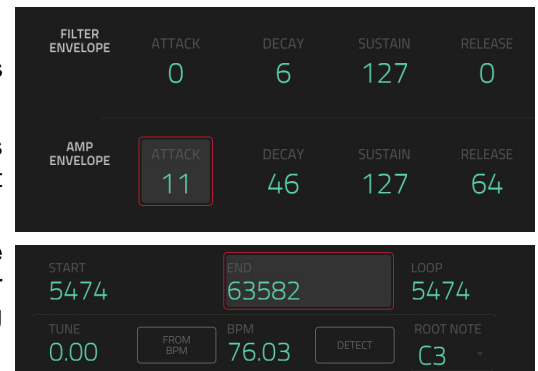

## Drop-Down Menus / Lists

To select an option for a drop-down menu, do any of the following:

- Tap the field to select it, and then use the **data dial** or **-/+** buttons to select an option.
- Double-tap the field. In the list that appears (examples below), tap the desired option. Alternatively, use the **data dial** or the **-/+** buttons to select an option.

In some windows, tap the relevant button at the bottom of the screen to confirm your selection or to cancel without changing anything.

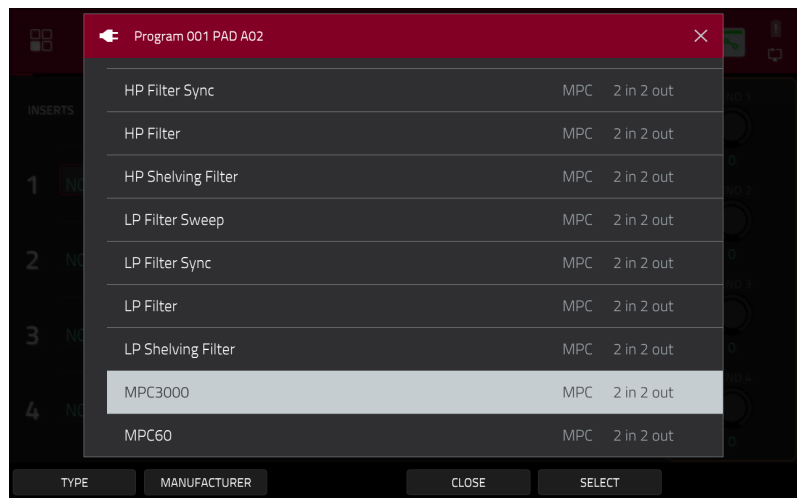
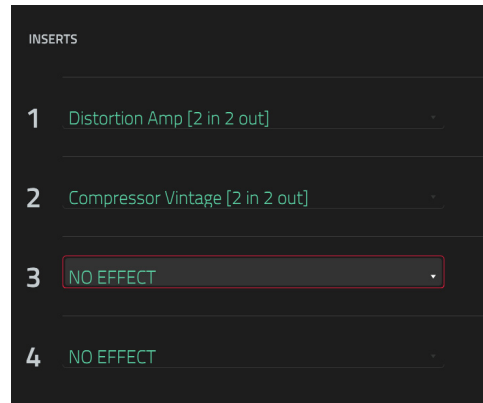
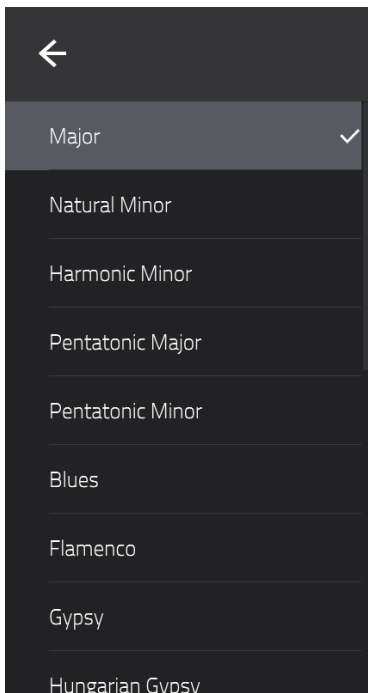
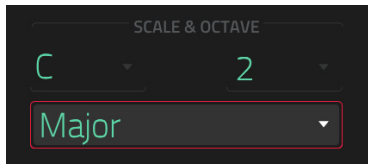

## Selectors

Selectors show all available options. One of them is always selected. The selected option is highlighted while the others are dark.

To select an option, tap it.

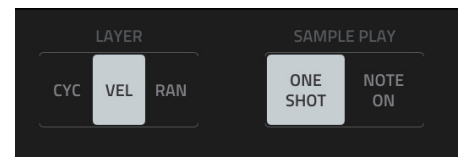

## Buttons

Buttons usually have two states: selected and deselected (active or inactive, respectively). Some may have more than two states.

To switch between or cycle through a button's states, do either of the following:

- Tap it.
- If it is outlined in red (and is not a mute button), use the **data dial** or **-/+** buttons.



## Checkboxes

Checkboxes have two states: checked and unchecked (enabled or disabled, respectively).

To check or uncheck a checkbox, tap it.

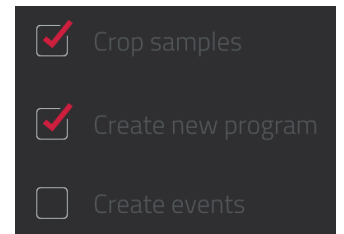

## Tabs

Some modes have buttons at the bottom of the screen that let you cycle through several similar tabs. For instance, you could view the send level that is routed to each of four returns—each level is shown on a separate tab. With each tap, you will move to the next tab, indicated by the squares below it.

To select a tab, tap it. Each time you tap it, it will select the next tab.

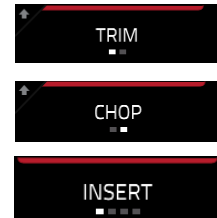

## Sliders

To adjust the position of a slider, do any of the following:

- Tap and drag the slider to the desired position.
- Tap the desired position (this works only on some sliders).
- Tap the slider to select it, and then use the **data dial** or **-/+** buttons to adjust the position (this works only on some sliders).
- Double-tap the slider, and then tap and drag the larger version that appears, or use the **data dial** or **-/+** buttons to adjust the value. If the slider controls a volume level, double-tap the larger version to reset it to **0 dB**. Tap anywhere else to return to the previous screen.

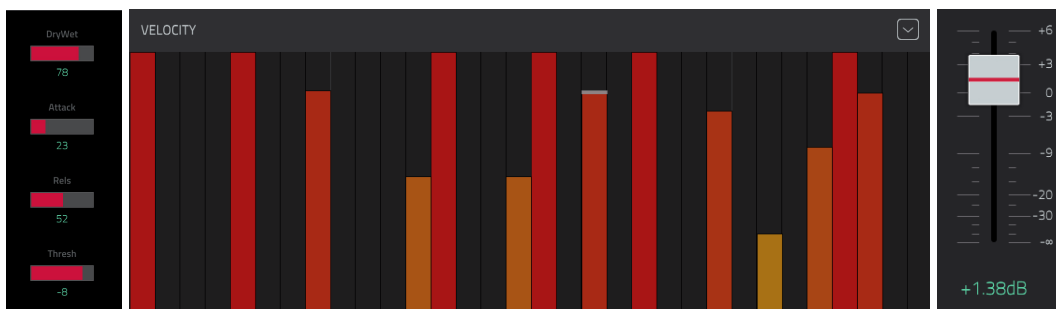

## Envelopes

To set the stages of an envelope, do either of the following:

**Tip:** Tap the **expand-rectangle icon** above the envelope to show a close-up view.



- Tap and drag a “handle” of an envelope stage in the desired direction.
- Set the numeric value of an envelope stage by adjusting or entering it as a parameter value (described [earlier](#)).

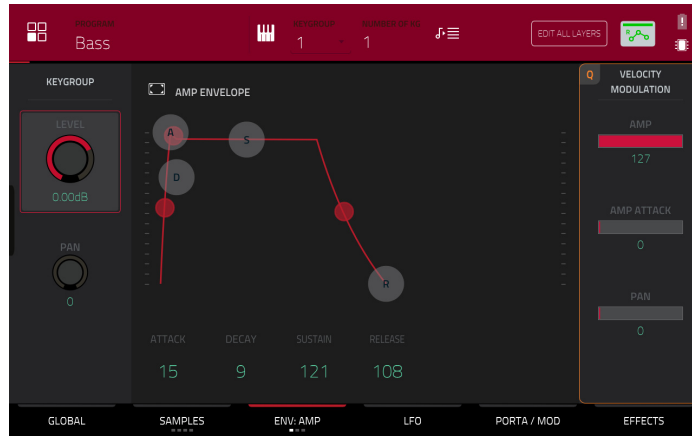

The Envelope tab in Program Edit Mode.

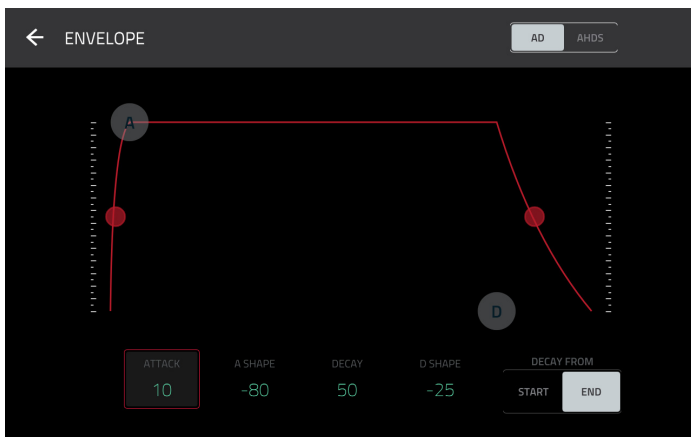

Close-up of an AD-type filter envelope.

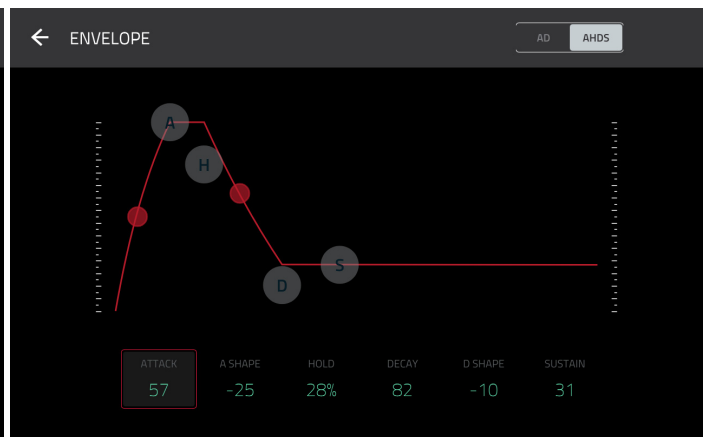

Close-up of an AHDS-type amp envelope.



## Grid View Tools

In the Grid View, these four icons enable you to use different functions in the grid.



Tap one to select its mode:



**Pencil:** Draw Mode:

**To enter a note in an empty grid square**, tap the grid square.

**To select a note**, tap it.

**To move a note**, tap and drag it to another grid square.

**To erase a note**, double-tap it.



**Eraser:** Erase Mode:

**To erase a note**, tap it.



**Select Box:** Select Mode:

**Note:** Notes will remain selected if you switch to another mode. The selection will change, however, if you press a pad while **Hitting Pad Selects All Events** is set to **On**.

**To select a note**, tap it.

**To select multiple notes**, tap and drag across the grid to create a box around them.

**To move a note**, tap and drag it to another grid square.

**To move multiple notes**, select them as described above, and tap and drag them.

**To erase multiple notes**, select them as described above, and then select the **eraser tool** and tap any of the selected notes.



**Magnifying Glass:** Navigation Mode:

**To move to another part of the grid**, tap and drag it.

**To zoom in or out**, spread or pinch your fingers (respectively) on the grid. You can do this vertically, horizontally, or both at the same time.

## Audio Edit Tools

In Audio Edit Mode, these six tool icons enable you to use different functions in the waveform.



Tap one to select its mode:



**Marquee:** Marquee Mode:

**To select a track region**, tap the upper third of it.

**To move a track region** (or multiple selected track regions), tap and drag the upper third of it left or right.

**To split the track at two specific points** (creating a track region on either side and between them), tap and drag across the middle third of it to create a translucent white box, and then tap the upper third of that box.

**To shorten or lengthen a track region** (or multiple selected track regions), tap and drag the lower third of it left or right.



**Arrow:** Selection Mode:

**To select a track region**, tap it.

**To select multiple track regions**, tap and drag across the grid to create a box that highlights them. Double-tap the selected track regions to deselect them.

**To move a track region** (or multiple selected track regions), tap and drag the upper third of it left or right.

**To shorten or lengthen a track region** (or multiple selected track regions), tap its edge and drag it.



**Eraser:** Erase Mode:

**To select multiple track regions**, tap and drag across the grid to create a box that highlights them.

**To erase a track region** (or multiple selected track regions), tap it.



**Scissors:** Split Mode:

**To split the track at a specific point** (creating a track region on either side), tap that point in the track.

**To select a track region**, tap its left-most edge.

**To select multiple track regions**, tap and drag across the grid to create a box that highlights them. Double-tap the selected track regions to deselect them.



**Mute:** Mute Mode:

**To select multiple track regions**, tap and drag across the grid to create a box that highlights them. Double-tap the selected track regions to deselect them.

**To mute or unmute a track region** (or multiple selected track regions), tap it.



**Magnifying Glass:** Navigation Mode:

**To move to another part of the track**, tap and drag it.

**To zoom in or out**, spread or pinch your fingers (respectively) on the grid. You can do this vertically, horizontally, or both at the same time.

## Programs

### About Programs

Each track you create within a sequence is routed through a **program**. There are six types of programs, each of which determines how the track sounds or what it is used for. A single project can hold up to 128 programs.

This chapter covers how to create each program type.

To learn about editing your programs to your preference, see the [Modes > Program Edit Mode](#) chapter.

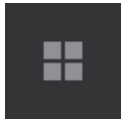
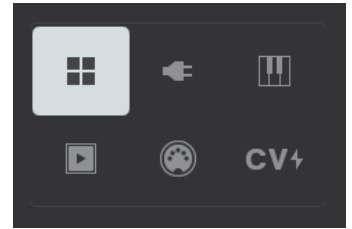

A **drum program** uses one or more samples as its sound source. It contains (1) a list of samples and (2) the settings for each sample (i.e., pad assignments, loop points, pitch tuning, effects, etc.). Drum programs are used mostly for creating drum parts and quickly and easily assigning samples to pads. See [Drum Programs](#) for more information.

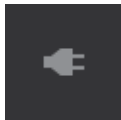

A **plugin program** contains an instance of a plugin through which you can send your track's MIDI data. See [Plugin Programs](#) for more information.

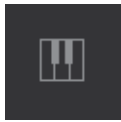

A **keygroup program** uses one or more samples as its sound source. It contains (1) a list of samples and (2) the settings for each sample (i.e., pitch tuning, effects, etc.). Keygroup programs are used to play samples chromatically with a MIDI keyboard or the MPC pads. See [Keygroup Programs](#) for more information.

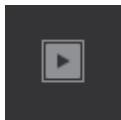

A **clip program** uses several samples that can be looped (clips). Each clip can be assigned to a pad, which you can press to trigger the clip according to a quantization setting. This lets you create intriguing, layered performances by launching different combinations of clips together. See [Clip Programs](#) for more information.

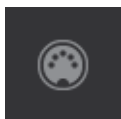

A **MIDI program** lets you send your track's MIDI data to an external MIDI device like a synth or drum machine. See [MIDI Programs](#) for more information.



A **CV program** lets you send your track's MIDI data to an external MIDI device that uses control voltage (CV), like a synth. See [CV Programs](#) for more information.

## Drum Programs

A drum program uses one or more samples as its sound source. It contains (1) a list of samples and (2) the settings for each sample (i.e., pad assignments, loop points, pitch tuning, effects, etc.). Drum programs are used mostly for creating drum parts and quickly and easily assigning samples to pads.

### To create a drum program:

1. Press **Main** to enter Main Mode.
2. Next to the **Track** field, tap the **four-squares icon**, which indicates a drum program.
3. If the project does not contain a drum program yet, a new drum program (named **Program**, appended with a number) will be added automatically to the project and appear in the **Program** field below.

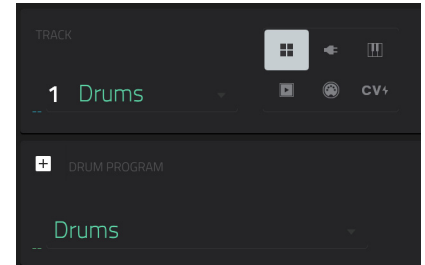

If the project already contains a drum program, the first one will be selected automatically and appear in the **Program** field below.

**To create another drum program**, tap the **+ icon** above the **Program** field. A new drum program will be created and appended with a number (e.g., **Program 002**).

**To rename the program**, tap the **cursor icon** on the right edge of the **Program** section. Use the virtual keyboard that appears to enter a new name, and then tap **Do It** to confirm or the **gray bar** at the top of the screen to cancel.

### To load a sample into a drum program:

1. Press **Browse** (MPC X, MPC One, MPC Studio), **Shift+Menu/Browse** (MPC Live, MPC Live II, MPC Key 61, MPC Touch), or **Load** (MPC Key 37) to show the Browser. Find and select a sample, and then tap **Load** to load it to the program. Repeat this for any other samples you want to load into the project. (See [Modes > Browser](#) to learn more about using the Browser specifically.)
2. Tap **Sample Assign** to view the pads and project's sample pool.
3. Press or tap a pad to select it. The pad will be lit green.
4. In the **Sample Pool** list, tap a sample to assign it to the pad. Alternatively, use the **data dial** or **-/+** buttons to assign a sample and/or change the assigned sample.

**To clear the assigned sample from a selected pad**, tap **Clear Pad**.

**To assign samples to additional pads**, repeat Steps 3–4.

**Tip:** Remember that a drum program has 128 pads total—16 pads across eight banks.

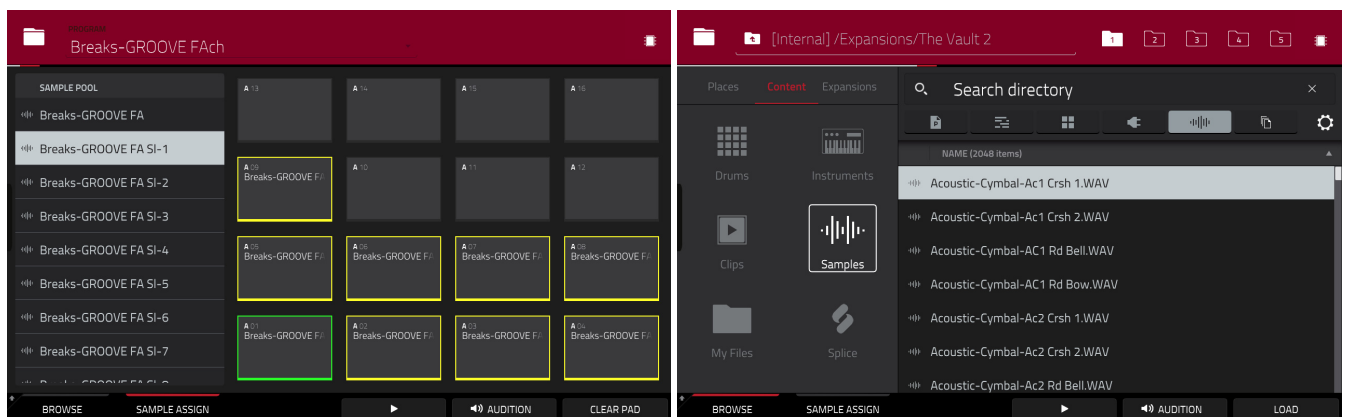

Alternatively, assign samples in a drum program in Program Edit Mode in one of these two ways:

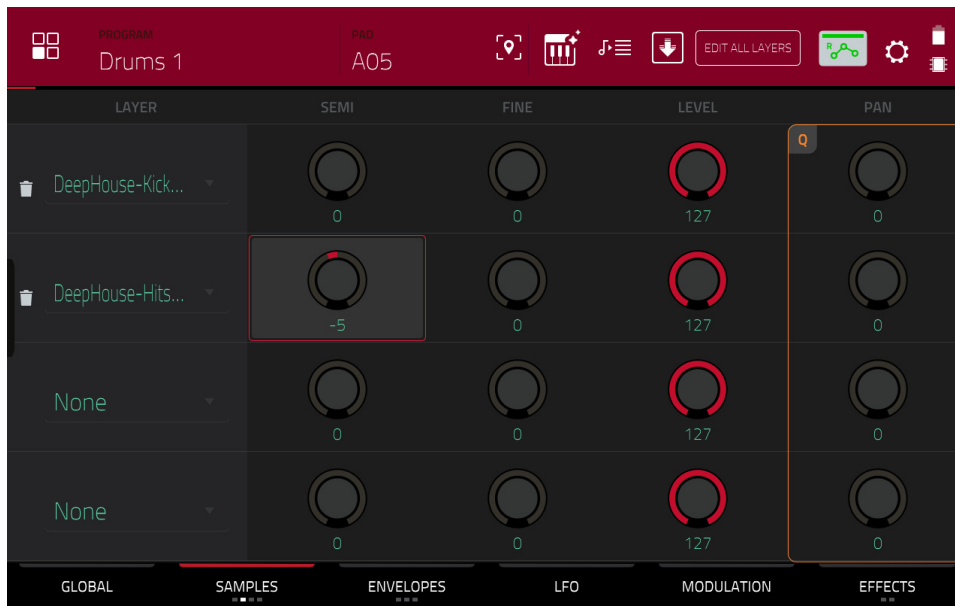

1. Press **Menu**, and then tap **Program Edit** to enter Program Edit Mode. Alternatively, press **Prog Edit** (MPC X, MPC One), or press **Edit** (MPC Key 61, MPC Key 37).
2. Tap the **Samples** to view any of the last three pages. These lets you view the samples assigned to all four layers of the current pad as well as other parameters such as tuning, level, panning, or offset for each layer.
3. Tap a pad to select it (and play its assigned samples, if any). The pad will be lit green.
4. Tap one of the **Layer** fields under the sample waveform to select a layer. Tap the **Sample** field, and then use the **data dial** or **-/+** buttons to select a sample. Alternatively, double-tap the field for a layer, and then tap a sample to select it.

## Plugin Programs

A plugin program contains an instance of a plugin through which you can send your track's MIDI data. This lets you use the same instance of a plugin with multiple tracks (rather than load an instance of a plugin on every track, which can be cumbersome and CPU-intensive).

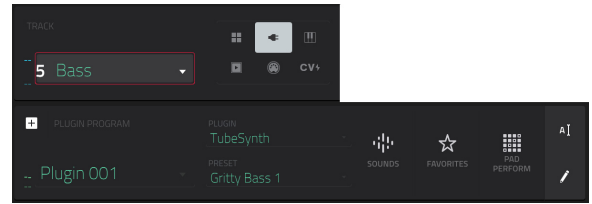

### To create a plugin program:

1. Press **Main** to enter Main Mode.
2. Next to the **Track** field, tap the **plug icon**, which indicates a plugin program.
3. If the project does not contain a plugin program yet, a new plugin program (named **Plugin**, appended with a number) will be added automatically to the project and appear in the **Program** field below.

If the project already contains a plugin program, the first one will be selected automatically and appear in the **Program** field below.

**To create another plugin program**, tap the **+ icon** above the **Program** field. A new plugin program will be created and appended with a number (e.g., **Plugin 002**).

4. Double-tap the **Plugin** field. In the list that appears, tap the desired plugin. Alternatively, use the **data dial** or the **-/+** buttons to select a plugin.

**To sort your plugins by type or maker**, tap **Type** or **Manufacturer**.

5. Tap **Select** to select the plugin, or tap **Close** to cancel.

**To select a preset in your plugin** (if any), double-tap the **Preset** field. In the list that appears, tap the desired preset. Alternatively, use the **data dial** or the **-/+** buttons to select a preset.

**To rename the program**, tap the **cursor icon** on the right edge of the **Program** section. Use the virtual keyboard that appears to enter a new name, and then tap **Do It** to confirm or the gray bar at the top of the screen to cancel.

You can also use the **Sounds** menu to browse plugins and presets or the **Favorites** menu to add and select your most-used sounds. See [Addenda > Updates in MPC 2.11 > New Features > Sounds and Favorites](#) for more information.

### To adjust the volume and panning of a track using the plugin program:

1. Press **Menu**, and then tap **Channel Mixer** to enter the Channel Mixer. Alternatively, press **Ch. Mixer** (MPC X), **Track Mix** (MPC One), or **Mix** (MPC Key 61, MPC Key 37).
2. Double-tap the **Mixer** field in the upper-left corner, and then tap **Midi Tracks**.
3. Tap the square that represents the track with the plugin program to select it.
4. Tap and drag the **volume slider** or **pan knob** up or down to adjust it. After you do this once, you can adjust the volume and panning of the plugin program normally.

### Important:

If you copy a sequence, the volume and pan values will be copied with that sequence. This is also true if you move to a new sequence and put the same plugin program on a new track.

By default, some plugins do not support MIDI volume and pan. In this case, adjust volume levels and panning on the plugin program.

## Keygroup Programs

A keygroup program uses one or more samples as its sound source. It contains (1) a list of samples and (2) the settings for each sample (i.e., pitch tuning, effects, etc.). Keygroup programs are used to play samples chromatically with a MIDI keyboard or the MPC pads.

### To create a keygroup program:

1. Press **Main** to enter Main Mode.
2. Next to the **Track** field, tap the **piano-keys icon**, which indicates a keygroup program.
3. If the project does not contain a keygroup program yet, a new keygroup program (named **Program**, appended with a number) will be added automatically to the project and appear in the **Program** field below.

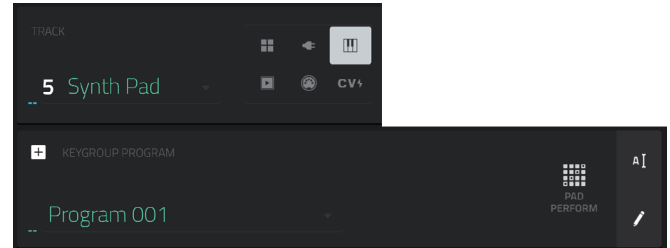

If the project already contains a keygroup program, the first one will be selected automatically and appear in the **Program** field below.

**To create another keygroup program**, tap the **+ icon** above the **Program** field. A new keygroup program will be created and appended with a number (e.g., **Program 002**).

**To rename the program**, tap the **cursor icon** on the right edge of the **Program** section. Use the virtual keyboard that appears to enter a new name, and then tap **Do It** to confirm or the gray bar at the top of the screen to cancel.

### To assign samples in a keygroup program:

1. Press **Menu**, and then tap **Program Edit** to enter Program Edit Mode. Alternatively, press **Prog Edit** (MPC X, MPC One), or press **Edit** (MPC Key 61, MPC Key 37).
2. Tap **Samples** to view any of the last three pages. These lets you view the samples assigned to all four layers of the current keygroup as well as other parameters such as tuning, level, panning, or offset for each layer.
3. Tap the **Number of KG** field, and then use the **data dial** or **-/+** buttons to set the number of keygroups in the program (**1–128**). Alternatively, tap the **Number of KG** field, and then use the numeric keypad to enter a value (or double-tap the **Number of KG** field, and then use the numeric keypad on the screen).
4. Tap the **Keygroup** field, and then use the **data dial** or **-/+** buttons to select a keygroup. Alternatively, double-tap the **Keygroup** field, and then tap a keygroup to select it.
5. Tap a pad to play the sample in the keygroup. The pad will be lit green.

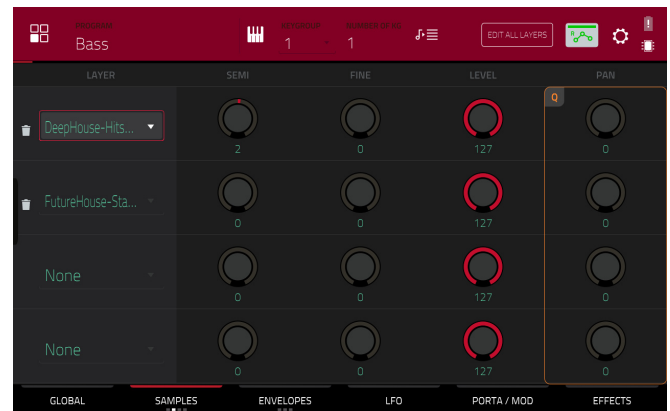

**Tip:** On your MPC hardware, disable Pad Perform and then press the **Pad Bank D** button to switch to Pad Bank D and press **Pad 13**. You should hear the bass sample played back with its original pitch. You can use the other pads to play your sample chromatically. Alternatively, you can play middle-C on an external MIDI device to hear the sample at the original pitch.

6. Tap the field for a layer, and then use the **data dial** or **-/+** buttons to select a sample. Alternatively, double-tap the field for a layer, and then tap a sample to select it.

To create complex keygroup programs, you can add more keygroups (up to 128). This is useful when working with multi-samples (e.g., when programming a real piano).

**Tip:** Remember that a keygroup program offers up to 128 keygroups, and each keygroup can hold up to four samples (Layers 1–4). This is a total of 512 samples.

## Clip Programs

A **clip program** uses several samples that can be looped (clips). Each clip can be assigned to a pad, which you can press to trigger the clip according to a quantization setting. This lets you create intriguing, layered performances by launching different combinations of clips together.

By default, the 16 pads are divided into four columns of four pads. Each column represents a mute group; when a pad is playing a clip, all other pads in that same mute group are turned off. This enables you to launch a clip without having to manually stop other clips that are similar. For instance, pressing Pad 2 may launch a bass clip. You could then press Pad 6, which launches another bass clip and stops the clip on Pad 2. This way, you'll never be playing two bass clips simultaneously.

The four-columns pad configuration described above is just a default to make things easy (e.g., you could use the first column for drum clips, the second for bass clips, the third for keyboard clips, and the fourth for vocal clips). You can use Program Edit Mode to assign pads to any combination of mute groups you want.

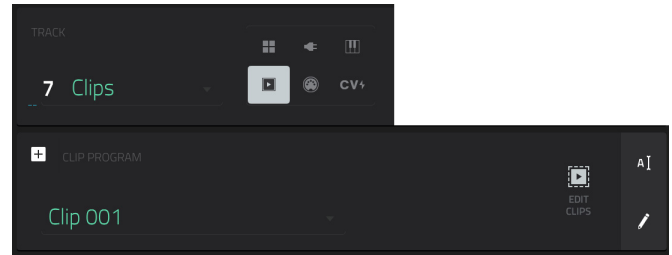

### To create a clip program:

1. Press **Main** to enter Main Mode.
2. Next to the **Track** field, tap the **play-button icon**, which indicates a clip program.
3. If the project does not contain a clip program yet, a new clip program (named **Clip**, appended with a number) will be added automatically to the project and appear in the **Program** field below.

If the project already contains a clip program, it will be selected automatically and appear in the **Program** field below.

**To create another clip program**, tap the **+ icon** above the **Program** field. A new clip program will be created and appended with a number (e.g., **Clip 002**).

**To rename the program**, tap the **cursor icon** on the right edge of the **Program** section. Use the virtual keyboard that appears to enter a new name, and then tap **Do It** to confirm or the gray bar at the top of the screen to cancel.



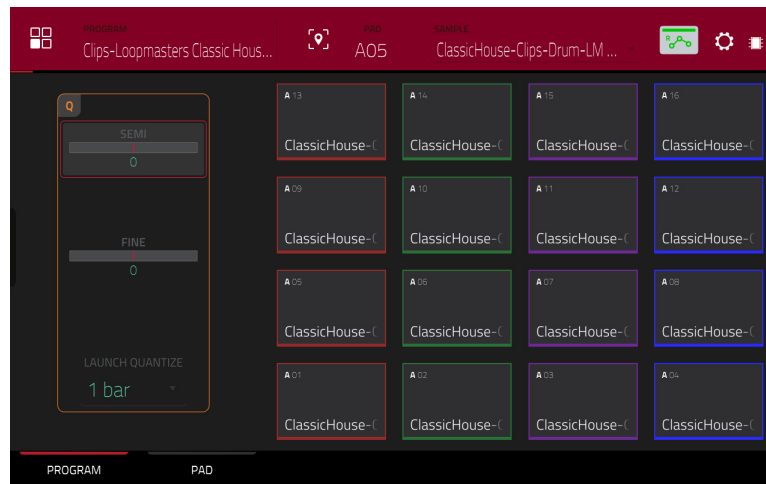

### To load a clip into a clip program:

1. Press **Main** to enter Main Mode.
2. Tap **Edit Clips** to view the pads and clip settings.
3. Press or tap a pad to select it (and play its assigned samples, if any). The pad on the screen will be lit red, and its number will appear in the **Pad** field.
4. Tap the **Sample** field, and then use the **data dial** or **-/+** buttons to select a clip. Alternatively, double-tap the **Sample** field, and then tap a clip to select it.

To clear the assigned clip from a selected pad, repeat Step 4, but select **None**.

To assign clips to additional pads, repeat Steps 3–4.

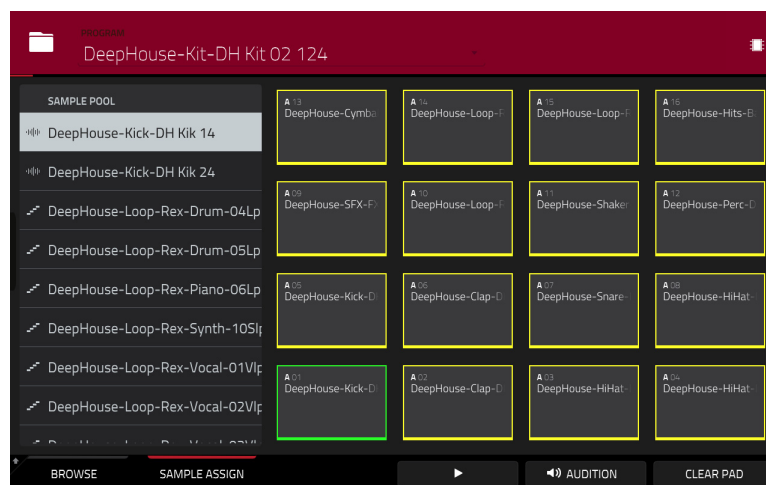

### Alternatively, assign clips in a clip program this way:

1. Press **Browse** (MPC X, MPC One, MPC Studio), **Shift+Menu/Browse** (MPC Live, MPC Live II, MPC Key 61, MPC Touch), or **Load** (MPC Key 37) to show the Browser. Find and select a clip, and then tap **Load** to load it to the program. Repeat this for any other clips you want to load into the project. (See [Modes > Browser](#) to learn more about using the Browser specifically.)
2. Tap **Sample Assign** to view the pads and project's sample pool.
3. Tap **Assign Mode** so it is selected (tapping an item in the sample pool will now assign it automatically to the current pad).
4. In the **Sample Pool** list, tap a clip to assign it to the pad. Alternatively, use the **data dial** or **-/+** buttons to assign a clip and/or change the assigned clip.

To clear the assigned clip from a selected pad, tap **Clear Pad**.

To assign clips to additional pads, repeat Steps 4–5.

## MIDI Programs

A MIDI program lets you send your track's MIDI data to an external MIDI device like a synth or drum machine.

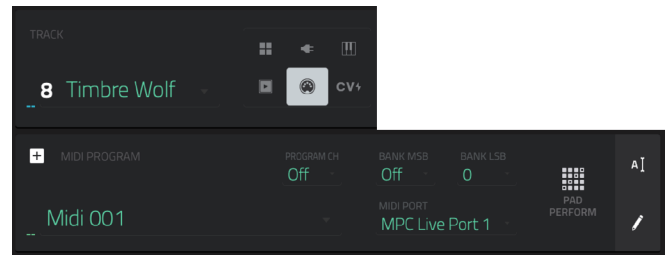

### To create a MIDI program:

1. Press **Main** to enter Main Mode.
2. Next to the **Track** field, tap the **MIDI-jack icon**, which indicates a MIDI program.
3. If the project does not contain a MIDI program yet, a new MIDI program (named **Midi**, appended with a number) will be added automatically to the project and appear in the **Program** field below.

If the project already contains a MIDI program, it will be selected automatically and appear in the **Program** field below.

**To create another MIDI program**, tap the **+** icon above the **Program** field. A new MIDI program will be created and appended with a number (e.g., **Midi 002**).

4. There are five additional settings to configure for a MIDI program: the **MIDI Port**, program change message (**Program Ch**), MIDI channel (**MIDI Ch**), Most Significant Byte (**Bank MSB**), and Least Significant Byte (**Bank LSB**). See [this section](#) to learn more.

**To configure each setting**, double-tap its field. In the list that appears, tap the desired option. Alternatively, use the **data dial** or the **-/+** buttons to select an option.

**Note:** You also have to configure the MIDI ports in the software's **Preferences** (in the **Edit Menu**). See the user guide in the MPC software to learn more: click the **Help** menu, select **MPC Help**, and select **MPC User Manual**.

**To rename the program**, tap the **cursor icon** on the right edge of the **Program** section. Use the virtual keyboard that appears to enter a new name, and then tap **Do It** to confirm or the gray bar at the top of the screen to cancel.

### To adjust the volume and panning of a track using the MIDI program:

1. Press **Menu**, and then tap **Channel Mixer** to enter the Channel Mixer. Alternatively, press **Ch. Mixer** (MPC X), **Track Mix** (MPC One), or **Mix** (MPC Key 61, MPC Key 37).
2. Double-tap the **Mixer** field in the upper-left corner, and then tap **Midi Tracks**.
3. Tap the square that represents the track with the MIDI program to select it.
4. Tap and drag the **volume slider** or **pan knob** up or down to adjust it. After you do this once, you can adjust the volume and panning of the MIDI program normally.

**Important:** If you copy a sequence, the volume and pan values will be copied with that sequence. This is also true if you move to a new sequence and put the same MIDI program on a new track.

## CV Programs

A CV program lets you send your control voltage (CV) signals to an external MIDI device like a synth or drum machine that uses CV.

### To create a CV program:

1. Press **Main** to enter Main Mode.
2. Next to the **Track** field, tap the **CV icon**, which indicates a CV program.
3. If the project does not contain a CV program yet, a new CV program (named **CV**, appended with a number) will be added automatically to the project and appear in the **Program** field below.

If the project already contains a CV program, it will be selected automatically and appear in the **Program** field below.

**To create another CV program**, tap the **+ icon** above the **Program** field. A new CV program will be created and appended with a number (e.g., **CV 002**).

4. Tap the **keys icon** to select a **Melodic** operation. This is the same as the traditional CV program operation. There are five additional settings to configure for a Melodic CV program: the note tracking (**Note**), the **CV Port**, the **Gate Port**, the modulation wheel (**Mod Wheel**), and **Velocity Port**.

Tap the **pads icon** to select a **Drum** operation. In this mode, tap the **four squares with note icon** to assign each pad to a specific CV port and set its data type.

**To rename the program**, tap the **cursor icon** on the right edge of the **Program** section. Use the virtual keyboard that appears to enter a new name, and then tap **Do It** to confirm or the gray bar at the top of the screen to cancel.

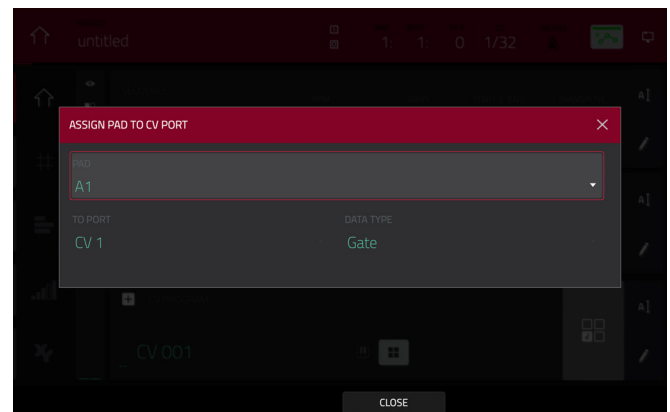
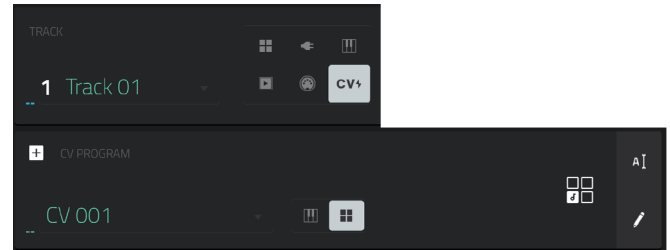
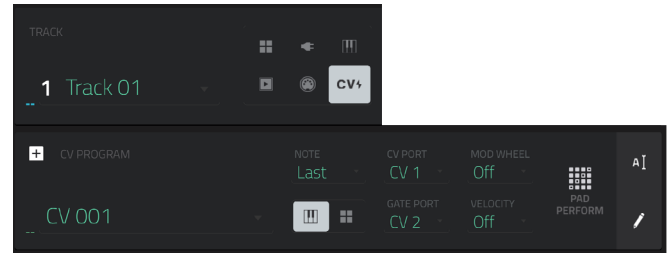

## Menu

The Menu lets you select any of the 21 modes, save or start a new project, set your preferences, switch between Standalone Mode and Controller Mode (except MPC Studio and MPC Touch), or view your system resources.

**To open the Menu**, press **Menu**, or tap the icon in the upper-left corner of the screen while on the normal page of your current mode.

When viewing the Menu, do any of the following:

**To enter a mode**, tap it.

**Important:** If a sequence is currently playing, you will not be able to enter Song Mode. Stop playback before entering Song Mode.

**To return to the previous mode**, tap the gray area in the upper-left corner, or press **Menu** again.

**To start a new project**, tap **New Project** at the bottom of the screen.

You can also press and hold the **Menu** button and press a pad to select a menu mode. The pads follow the 4x4 layout of the main body of the Mode Menu.

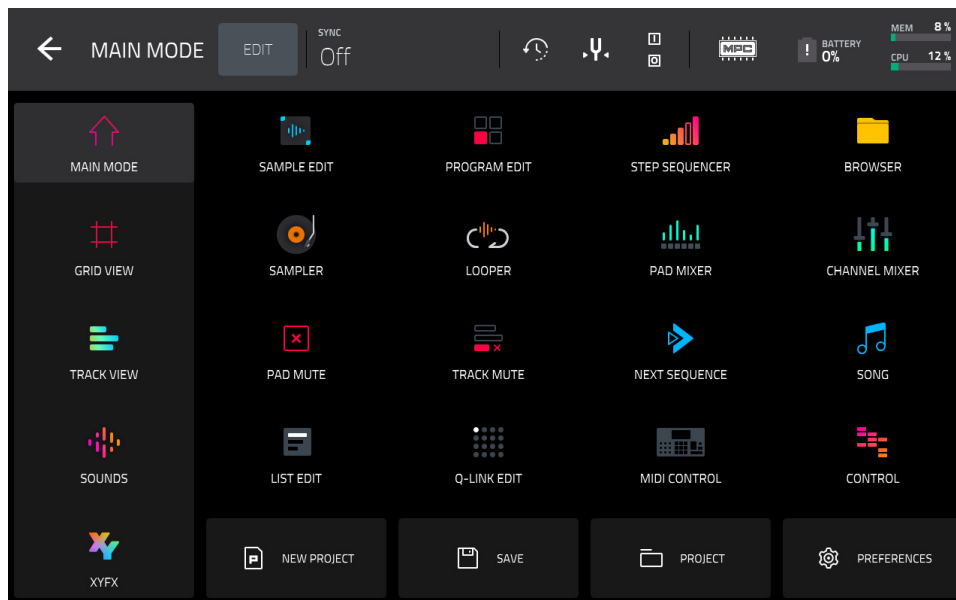

AUDIO EDIT

**Note:** The Menu above is available when the currently selected track is a MIDI track. When an audio track is selected, it will show an icon for **Audio Edit Mode** instead of Grid View.

Click a part of the screen above to skip directly to that part of this user guide.

You can also edit the Menu layout by tapping the **Edit** button. Once enabled, tap and drag the menu icons to your preferred location, and then tap **Edit** again to save your changes. This is useful for putting your most-used modes in the left-most column so that they are easily accessed in any mode by swiping to the right from the left edge of the touchscreen. See [Addenda > Updates in MPC 2.11 > New Features > Menu Editing and Shortcuts Panel](#) for more information.

## Save

To open the save selector window, tap the **Save** button at the bottom of the screen.

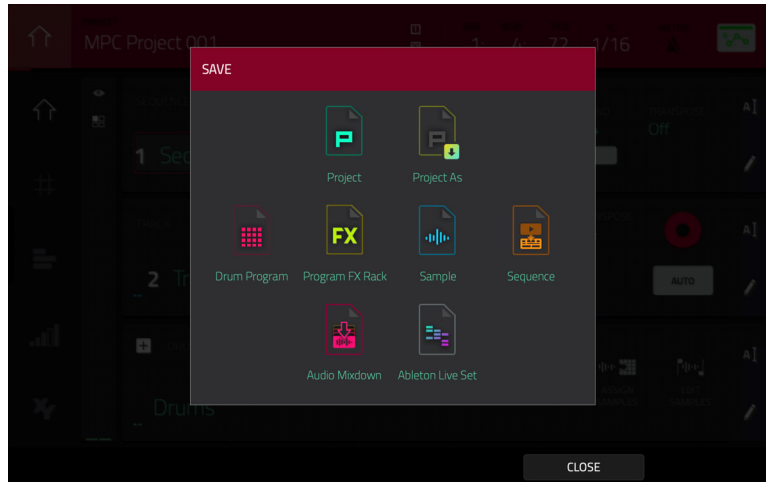

To save a project, tap **Project** or **Project As**. If a project has not been saved before, both options will open the save path window, described below. If a project has been saved before, tapping **Project** will automatically overwrite the most recently saved version.

To save the current drum program, tap **Drum Program** when a Drum program is selected.

To save the current plugin program, tap **Plugin Program** when a Plugin program is selected.

To save the current keygroup, tap **Keygroup** when a Keygroup program is selected.

To save the current MIDI program, tap **MIDI Program** when a MIDI program is selected.

To save the current clip program, tap **Clip Program** when a clip program is selected.

To save the current CV program, tap **CV Program** when a CV program is selected.

To save the current program inserts, tap **Program FX Rack**.

To save the currently selected sample, tap **Sample** when the sample's pad is selected. If a pad has multiple layers, the sample currently selected for the pad in Sample Edit mode will be saved.

To save the current sequence, tap **Sequence**.

To save the project as an audio mixdown, tap **Audio Mixdown**.

Use the **Start Bar** and **End Bar** fields under Audio Length to set the time range that you want to mix down. You can add a number of seconds to the end of the mixdown to capture any ringing notes or effects (such as a reverb tail) by adjusting the **Audio Tail** field.

Use the fields under **Render Source** and **Render Options** to set the parameters for the audio mixdown. Check the **Separate Tracks** box to render each track of the arrangement as stems.

Use the fields at the bottom of the screen to configure the audio mixdown settings. You can set the **File Format**, **Bit Depth**, and **Sample Rate**.

To save the project as an Ableton Live set, tap **Ableton Live Set**.

Use the **Export MIDI As** settings to choose how MIDI tracks and clips are exported, either as **Audio** files or **MIDI** files. When using Plugin, Drum or Keygroup programs, you can render clips as **Audio** to preserve the sound of the instruments, or render clips as **MIDI** data.

Check the **Include Program Volume/Pan Settings** box to include these settings in the export. When disabled, the volume and pan settings will be set to **0 dB** and center (**C**), respectively.

Check the **Bypass Program Effects Plugins** box to deactivate any third-party effect plugins used with the program for the export. When disabled, those effects will be activated.

Use the **Audio Tail** field to set the amount, in **seconds**, of extra time added to the end of the resulting audio files.

Use the **Bit Depth** field to set the bit depth to **8**, **16** or **24**.

Use the **Sample Rate** field to set the sample rate to **44.1**, **48**, **88.2** or **96 kHz**.

To close the window and return to the menu, tap **Close** or anywhere outside the window.

After selecting the save type, use the following to select a save location:

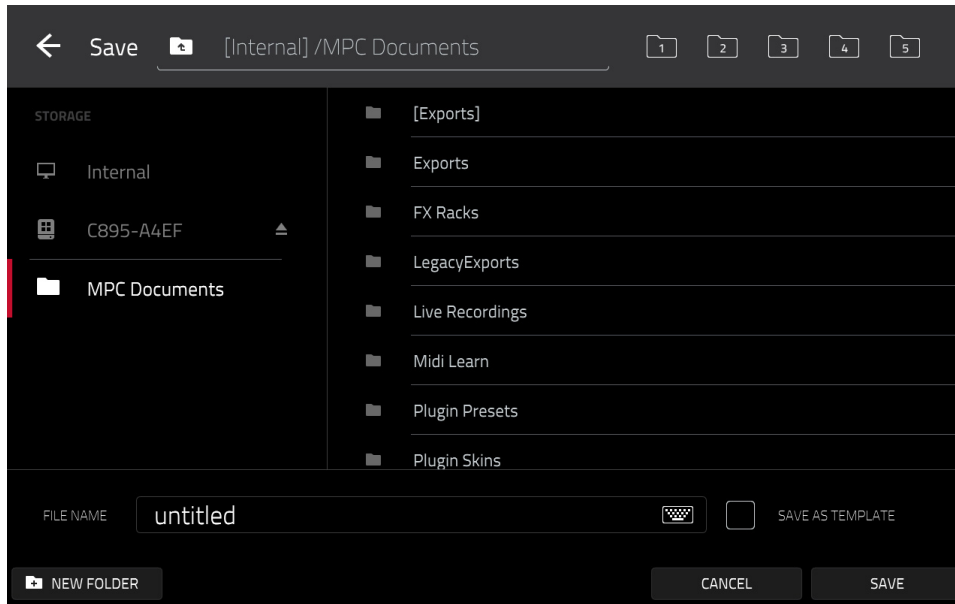

**To select the storage device you want to view**, tap it in the **Storage** column on the left.

**Internal** is the internal drive of MPC X/Live/Live II/One/Key 61/Key 37.

**MPC Documents** is a shortcut to the **MPC Documents** folder on the internal drive of MPC X/Live/Live II/One/Key 61/Key 37.

If you have storage devices connected to a USB port or SD card slot of MPC X/Live/Live II/One/Key 61/Key 37, or your computer (with MPC Studio or MPC Touch), they will also appear in this column.

**To enter a folder**, double-tap it. Alternatively, turn the **data dial** or use the **-/+** buttons to move through the list, and press the **data dial**, or the **center cursor** or **Enter** (MPC X), to enter a folder. You can also tap one of the five **folder buttons** in the upper-right to jump immediately to those pre-assigned file paths (see [Modes > Browser](#) to learn how to do this).

**To create a new folder**, tap **New Folder**, use the virtual keyboard that appears to enter a name, and then tap **Do It**. You will immediately enter the new folder.

**To move up one folder level**, tap the **folder/L icon** in the upper-left corner.

**To name the file**, tap the **File Name** field at the bottom of the screen, and use the virtual keyboard that appears.

**To save the file**, tap **Save**.

**To save the file as a project template file**, tap the **Save as Template** checkbox to check it before tapping **Save**. (This file will be shown in the **Template File** field in the Preferences' **Project Load/Save** tab.)

**To cancel and return to the Menu**, tap **Cancel**. Alternatively, tap the **← icon** in the upper-left corner.

## Preferences

**To open the Preferences**, tap the **Preferences button** at the bottom of the screen.

**To return to the Menu**, tap the ← icon in the upper-left corner. Changes to the **Preferences** are saved automatically except for **Vintage Mode** (in the **General** tab) and **Start Time** (in the **Sync** tab).

**To restore your MPC hardware's default settings**, tap **Reset Preferences**. In the screen that appears, tap **OK** to continue or **Cancel** to return to the Preferences. In the next window, tap **Save** to save your current project before restoring the default settings; tap **Cancel** to return to the Preferences; or tap **Don't Save** to restore the default settings without saving your current project.

**Important:** For MPC X, MPC Live, MPC Live II, MPC One, MPC Key 61, and MPC Key 37, the Preferences will appear differently in Controller Mode than in Standalone Mode. Some of the options described in this section may be available in only one of these modes or in a different order. For MPC Studio, consult the MPC Software User Guide by going to **Help > MPC Help > MPC Software Manual** for more information on the software preferences.

## Info

This screen shows current information about your MPC hardware: its current firmware version, which includes its standalone operating system (**MPC Firmware**); its hardware **Serial Number**; and its current firmware for the **Control Surface**.

**To enter Update Mode**, tap **Update**. In the screen that appears, tap **Save** to save your current project before entering Update Mode; tap **Cancel** to return to the Preferences; or tap **Don't Save** to enter Update Mode without saving your current project.

**To view legal information relevant to MPC**, press and hold **Shift** and tap **Legal Info**. For complete legal information, visit [akaipro.com/product-legal](http://akaipro.com/product-legal).

**To view detailed version information**, press and hold **Shift** and tap **Version Info**.

## Activate Plugins

The settings on this screen allow you to sign in to your inMusic Profile to activate purchased plugin licenses.

1. First, make sure you are connected to a Wi-Fi network.
2. In the Activate Plugins menu, tap the **Log In** button to log into your inMusic Profile. You can scan the QR code with a mobile device or open the URL shown on the page in a browser of your choice. Enter the code shown on your device and log into your account. If you do not already have an account, you will be prompted to create one.
3. Once you have been logged in, you can try out plugin instruments through a free trial, or activate your purchases.

**To start a trial**, tap the **Get Trial** button next to the desired plugin.

**To register a purchase**, use the **Enter Serial** field to enter your serial number and then tap **Register**.

**To refresh the page with your latest purchases or activations**, tap **Refresh**.

**To activate a plugin on your device**, tap the **Activate** button next to its name. Tap **Deactivate** to remove the plugin activation from your device.

**To download a purchase to your device**, first tap the **Change** button at the bottom of the touchscreen to select a Content Download Drive. This can be the internal storage drive or a connected SATA drive, USB drive, or SD card. Then, tap the **download icon** to begin downloading the plugin to your drive. The download icon will change to show the installation progress. Once the process is complete, you can use your plugin with standalone MPC.

**To log out of your account**, tap **Log Out**.

## Wi-Fi

The settings on this screen will determine how your MPC hardware's wireless connection works, so you can use Ableton Link, a new technology that synchronizes beat, phase and tempo of Ableton Live and Ableton Link-enabled applications over a wireless or wired network. These settings are available only for MPC X, MPC Live, MPC Live II, MPC One+, MPC Key 61, and MPC Key 37 when used in Standalone Mode.

**To activate or deactivate wireless connectivity on your MPC hardware**, tap the **On/Off** selector. The available wireless networks will appear in the panel below it.

**To select a wireless network**, tap it.

**To connect to a selected wireless network**, tap **Connect**. If the Wi-Fi network is password-protected, use the virtual keyboard that appears to enter the correct password to connect to it.

**To view the information of a selected wireless network**, press and hold **Shift** and tap **Info**. The **Network Information** window that appears will show the network name, IPv4/IPv6 address (including the subnet mask and gateway), type of security, and signal strength (as a percentage).

**To disconnect from a connected wireless network**, tap **Disconnect**.

**To clear the connection information** (e.g., the password) **from a selected wireless network**, tap **Forget**.

## Ethernet

The settings on this screen will determine how your MPC hardware connects to a wired network using a USB-to-Ethernet adapter or Ethernet cable (MPC One, MPC Live II, MPC Key 61 only). This allows you to maintain a tighter network connection when using Ableton Link or the Akai Network Driver. These settings are available only for MPC X, MPC X SE, MPC Live, MPC Live II, MPC One, MPC One+, MPC Key 61, and MPC Key 37 when used in Standalone Mode.

**To activate or deactivate Ethernet connectivity on your MPC hardware**, tap the **Enabled** box.

**To determine how your MPC hardware connects to the network**, use the **Address Method** dropdown. Select **Automatic** to have your MPC hardware set the Ethernet connection, or **Manual** to set it yourself.

When setting the Ethernet connection manually, tap the **IP Address**, **Subnet Mask**, **Gateway**, and **DNS** fields to input the values.

## Bluetooth

The settings on this screen will determine how your MPC hardware's Bluetooth connection works, so you can use Bluetooth MIDI controllers (e.g., LPD8 Wireless or LPK25 Wireless) or a Bluetooth computer keyboard with it. These settings are available only for MPC X, MPC X SE, MPC Live, MPC Live II, MPC One+, MPC Key 61, and MPC Key 37 when used in Standalone Mode.

**To activate or deactivate Bluetooth connectivity on your MPC hardware**, tap the **On/Off** selector. The available Bluetooth devices will appear in the panel below it under **Available Devices**. The Bluetooth devices that have already paired to your MPC hardware will appear under **Paired Devices**.

**To select a Bluetooth device**, tap it.

**To pair a selected Bluetooth device** (in the Available Devices section), tap **Pair**.

**To connect to a selected Bluetooth device** (in the Paired Devices section), tap **Connect**.

**To disconnect from a connected Bluetooth device** (in the Paired Devices section), tap **Disconnect**.

**To return an available Bluetooth device to its original state**, tap **Remove**.

## Audio Device

The settings on this screen allow you to set up an external USB and Linux class-compliant audio interface for use with your MPC hardware. See [Addenda > Updates in MPC 2.10 > New Features > Standalone Audio Interface Support](#) to learn more.

**Note:** If you are unsure of your audio interface's compatibility, check with the original equipment manufacturer for more information.



## MIDI / Sync

The settings on this screen determine how your MPC hardware uses and synchronizes with connected USB and MIDI devices.

**Input Ports:** This displays all available MIDI input ports in a list. Double-tap the **keyboard icon** to rename a port to a custom name. When **Global** is enabled, MIDI data from this port will always go to the current track. When **Control** is enabled, MIDI data from this port will be sent to MIDI Learn. When **Track** is enabled, this MIDI port will appear in the list of available MIDI Inputs. Click the **reset arrow** to reset the MIDI Port settings.

**Output Ports:** This displays all available MIDI output ports in a list. Double-tap the **keyboard icon** to rename a port to a custom name. When **Sync** is enabled, the MIDI output port will send MIDI sync messages according to the type set under Sync **Send**, below. When **Track** is enabled, this MIDI port will appear in the list of available track MIDI outputs. Click the **reset arrow** to reset the MIDI Port settings.

**Enable MIDI Ports When Discovered:** When enabled, any time a MIDI device is plugged in the Track option is automatically enabled so the ports can be selected as an available MIDI input or output.

**MIDI Control Mode Output:** This determines which MIDI port the MPC hardware is using to send MIDI messages to external MIDI devices.

**Receive:** This determines whether your MPC hardware receives MIDI Clock information (**MIDI Clock**), MIDI Time Code information (**MIDI Time Code (MTC)**), communication from Ableton Link (**Ableton Link**), or none of these (**Off**).

**Important:** Audio recording is disabled when receiving MIDI Clock sync. Use MIDI Time Code to record audio while receiving MIDI sync.

**Receive MMC:** When enabled, your MPC hardware will be able to receive MIDI Machine Control (MMC) information. When disabled, your MPC hardware will not receive this information. See [Appendix > MIDI Machine Control \(MMC\)](#) to learn about this.

**Send:** This determines whether your MPC hardware sends MIDI Clock information (**MIDI Clock**), MIDI Time Code information (**MIDI Time Code (MTC)**), or neither (**Off**).

**Send MMC:** When enabled, your MPC hardware will be able to send MIDI Machine Control (MMC) information. When disabled, your MPC hardware will not send this information. See [Appendix > MIDI Machine Control \(MMC\)](#) to learn about this.

**MTC Frame Rate:** This determines the frame rate used by MIDI Time Code (MTC), which is important for correct timing, especially when working on film scoring projects. In most cases, you should select **25**.

**Start Time:** This is the starting time that will be sent when **Send MIDI** is set to anything other than **Off**. The time is formatted in **hours:minutes:seconds:frames**.

**Filter 'All Notes Off' CC:** When enabled, "All Notes Off" ("MIDI panic") messages will be ignored. This is useful if you are using an external MIDI device that can send these types of messages but you want to filter them out. When disabled, "All Notes Off" messages will be received normally.

**Program Change:** This determines what an incoming MIDI program change message will change: a **Program**, **Sequence**, or **Track**.

## Hardware

The settings on this screen determine the behavior of your MPC hardware's pads and touchscreen.

**Pad Threshold:** This determines how much force is required to strike the pads for them to trigger.

**Pad Sensitivity:** This determines how the pads respond to touch. At lower values, you need to use more force to generate a high-velocity note. At higher values, it is easier to generate high-velocity notes, even if you do not use much force while pressing a pad.

**Pad Curve:** This determines how striking the pads translates into velocity values. The **A** curve is essentially linear, while the **B**, **C**, and **D** curves are exponential (see graphic here).

**Velocity & Aftertouch:** View these meters when striking and pressing the pads to help gauge the force and pressure you are applying to them. These meters are useful when adjusting the Pad Threshold and Pad Sensitivity parameters (above).

**Footswitch 1 & Footswitch 2 (MPC X only):** These determine how connected footswitches will work.

**Screen Dimming:** This determines how much time must pass before your MPC hardware automatically dims its touchscreen (if it uses a battery, this can help preserve battery life).

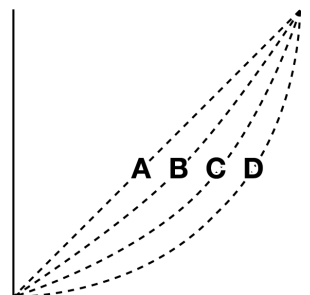

**Screen Brightness:** This determines the brightness of the screen during normal operation: normal brightness (**Day**) or dimmed (**Night**).

**Power On Screen** (MPC Live, MPC Live II only): This determines if/when a special screen will appear when you power on your MPC Live. On this screen, you must tap and hold a button for a moment to begin using MPC Live or it will automatically power off. This feature prevents it from powering on accidentally and wasting battery life. You can set it to the following options:

**Never:** The screen will never appear.

**When On Battery:** The screen will appear only if you power on MPC Live while using battery power.

**Always:** The screen will always appear.

**Tap Tempo:** This determines how many times you have to press the **Tap** button before the new tempo is recognized.

**Flash Tap Tempo Light:** When enabled, the **Tap** button's light will flash in time with the tempo. When disabled, the **Tap** button's light will be off.

**Bank Button Press:** This determines how the **Pad Bank** buttons work.

**Select A-D:** Pressing a **Pad Bank** button once will select the corresponding bank from Pad Banks A–D. Pressing and holding **Shift** while pressing a **Pad Bank** button will select the corresponding bank from Pad Banks E–H.

**Select/toggle bank:** Pressing a **Pad Bank** button will alternate between the corresponding bank from Pad Bank A–D and Pad Bank E–H. In other words, you do not need to hold Shift to select one of Pad Banks E–H.

**Shift + Q-Link Press:** This setting determines whether pressing **Shift** and the **Q-Link** button opens **Q-Link Edit** or **Cycles Backwards** between the Q-Link columns.

**Global Pitch Bend:** Enable this option to override the pitch bend settings of all programs, so that those with pitch bend disabled or set to different ranges will only use the Global Range instead. When disabled, all programs may use their individual pitch bend settings.

**Range Down / Range Up:** Use these fields to determine the range of pitch bend in semitones.

**VU Meter Source** (MPC X only): This determines what audio signal level is shown in the level meters (on the right side of the screen). When set to **Main**, the level meters show the audio signal sent out of **Outputs 1/2** (the **Main L/R outputs** on the rear panel). When set to **Current Program**, the level meters show the audio signal of the currently selected program (i.e., the program used by the currently selected track and any other tracks that also use it).

**Date** (not available for MPC Studio and MPC Touch): This is the current date, formatted as **Month / Day / Year**. When saving files on MPC in Standalone Mode, the file will include the current date in its metadata. If you use MPC in Controller Mode, this setting will be overwritten with the current date of the host computer.

**Time** (not available for MPC Studio and MPC Touch): This is the current time, formatted as **Hour : Minute**. When saving files on MPC in Standalone Mode, the file will include the current time in its metadata. If you use MPC in Controller Mode, this setting will be overwritten with the current time of the host computer.

**Time Zone** (not available for MPC Studio and MPC Touch): This is the current time zone, formatted as **Continent / City**, which you can change here.

## Sequencer

The settings on this screen determine how sequencing works in the Grid View and in the Step Sequencer.

**Instant Track Mute:** When disabled, if you mute a track, its Note On messages will be ignored, and samples and notes that are playing will finish playing their entire length (this is how legacy MPCs' track-muting worked). This is useful if you are using loops and want a loop to play to the end of a bar but **not** play the next time the sequence loops. When enabled, if you mute a track, the MIDI track volume (**0**) will be sent. The loop will continue to play but at zero volume, allowing the loop to continue playing when the track is unmuted. This is useful when you want to have the track muted immediately.

**Play Track Mute and Solo Events:** When enabled, track mute and solo events are played back when you are in Track Mute Mode. When disabled, track mute and solo events will not be played back while in Track Mute Mode.

**Rec Arm:** This determines the behavior of the Record Arm buttons. When set to **Single**, selecting a different track will automatically arm that track and disarm all other tracks. This is the default mode and is the same as previous MPC releases. When set to **Multi**, you can tap any track's record button to add it to the group of armed tracks. See [Addenda > Updates in MPC 2.8 > New Features > Single or Multi Record Arm](#) to learn more.

**Record Track Mute and Solo Events:** When enabled, track mute and solo events are recorded when you are in Track Mute Mode (timing correct settings will affect the recorded position events). When disabled, track mute and solo events will not be recorded while in Track Mute Mode. This feature is useful if you want to use Track Mute Mode to record track mutes or solos into your sequences as opposed to using Track Mute Mode for performance or listening purposes only.

**Record Pad Aftertouch Events:** When enabled, pad aftertouch data (from the MPC hardware's pressure-sensitive pads) will be recorded. When disabled, pad aftertouch data will be ignored.

**Place Events Recorded During Count-In at Start Point:** When enabled, pressing a pad during the recording's pre-count will record that note event at the start of the recording (this is how the MPC3000 worked). When disabled, no notes will be recorded until the pre-count is finished and recording has begun.

**Note:** This setting is ignored when recording with the Arpeggiator active.

**Truncate Duration:** This determines if/how events are cropped if they exceed the length of the current Sequence:

**To Sequence Length:** If the length of an event exceeds the length of the sequence, it will be truncated. This ensures that the event will not overlap itself when the sequence loops.

**To Sequence End:** If an event exceeds the length of the sequence, it will be truncated to the end of the current sequence. In other words, the event will stop playing when the sequence ends or loops.

**As Played:** Events will play back exactly as they were recorded, even if they overlap themselves when the sequence loops.

For example, if you record a note starting on the second bar of a 4-bar loop and hold it for 5 bars, the note would end: at bar 7 (As Played), at bar 6 (To Sequence Length), or bar 4 (To Sequence End). See image for details.

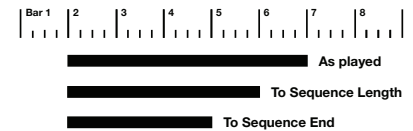

**Q-Link Swing Control Applies TC Settings on Release:** When enabled, turning the Q-Link knob assigned to **Swing** and then releasing it will immediately apply that Swing setting. When disabled, you must use the Timing Correct window to apply the Swing setting.

**Display Resolution:** This is the display resolution (in PPQN—pulses per quarter note) of pulse values in certain areas of the operating system. Please note that this setting affects the display resolution, not the timing.

## Project Defaults

The settings on this screen determine various default values for any new project that you create.

**New Project Dialog:** This determines what options you see when you start a new project. When set to **Off**, a new project will be empty with no preconfigured settings except for the project defaults shown here. When set to **Demo**, you can choose to load a demo project (from several different genres) as a starting point or an empty project. When set to **Demo/Template/Recent**, you can choose to load a demo project, a project template file, or an empty project. You must have a project in the **Template File** field of the **Project Load/Save** tab to select a template in this window.

**Default Tempo:** This is the default tempo in BPM.

**Default Global Tempo:** When enabled, the default tempo value will be used for the global tempo. When disabled, the default tempo will be used for sequences.

**Default Sequence Bars:** This determines the default number of bars of a new sequence.

**Default Time Signature Numerator:** This determines the number of beats per bar of a new sequence (the top number of a time signature).

**Default Time Signature Denominator:** This determines the value of each beat of a new sequence (the bottom number of a time signature).

**Default Pad Slice:** This determines how new samples will play when you load them or record them into a project. When set to **Pad**, the **Slice** menu in Program Edit Mode will be set to **Pad**, which lets you set the start point, end point, etc. for the layer. When set to **All**, the **Slice** menu in Program Edit Mode will be set to **All**, in which the entire sample plays.

**Default Drum/Keygroup Filter:** This determines the default type of filter that drum and keygroup programs will use. See [Appendix > Glossary > Filter](#) to learn about this.

**Default Plugin Synth:** This determines the default instrument plugin that a new plugin program will use. Use the window that appears to select it.

## Project Load/Save

The settings on this screen determine if (and how) projects are automatically saved. If you are using MPC hardware as a controller, you can also define files to load automatically.

**Auto Load File:** Use this field to select a project (.xproj) or program (.xpm) to load automatically anytime you open the MPC software or your standalone MPC hardware.

**Note:** If the New Project Dialog setting under **Project Defaults** is set to Demo or Demo/Template/Recent, selecting **Empty Project** will load the Auto Load project if one is selected. If no Auto Load project is selected, choosing **Empty project** will load an empty project. If you have an Auto Load project selected and would still like to create an empty project, press and hold **Shift** and then tap **Empty project**. If the **Project Defaults** is set to **Off**, the Auto Load project will be loaded on startup.

**Enabled:** When enabled, your project will automatically save after each **Timeout** interval. When disabled, your project will not be automatically saved; you may save only manually.

**Timeout:** Use this field to select how often your project will automatically save.

**Template File:** Use this field to select a project template that will load automatically when you select **User Template** in the **New Project Dialog** window. (If you select the **Save as Template** box when saving a file, it will be shown in this field.) In order for the **User Template** option to be available, **New Project Dialog** (in the **Project Defaults** tab) must be set to **Demo** or **Demo/Template/Recent**.

## Record/Export

The settings on this screen determine the settings for recording and exporting.

**Recording Bit Depth:** This determines the bit depth of recorded audio.

**Include Program Volume/Pan Settings:** When enabled, the exported audio or MIDI file will include its volume and pan settings. When disabled, the volume and pan settings will be set to **0 dB** and center (**C**), respectively.

**Bypass Program Effects Plugins:** When enabled, the exported audio or MIDI file will include any third-party effect plugins that are used with it, but those effects will be bypassed (deactivated). When disabled, those effects will be activated.

**Audio Tail Length:** This determines the length of an audio tail (silence) that will be applied to the exported audio file. When set to **0**, the audio file will not have any additional audio tail.

**Audio Export:** This determines what part of the sequence is exported when you click the **Export Audio** icon.

**Track:** When this is selected, **Export Audio** will export the currently shown track in the current sequence.

**Program:** When this is selected, **Export Audio** will export all tracks in that sequence that use the currently shown program.

**Main:** When this is selected, **Export Audio** will export all tracks in that sequence that use programs routed to main outputs.

**MIDI Export:** This determines what part of the sequence is exported when you click the **Export MIDI** icon.

**Track:** When this is selected, **Export MIDI** will export the currently shown track in the current sequence.

**Sequence:** When this is selected, **Export MIDI** will export all tracks in the current sequence.

**Bounce Bit Depth:** This determines bit depth of the audio file that is exported when you click the **Export Audio** icon: **16-bit** or **24-bit**.

## General

The settings on this screen determine how other features work in the hardware and operating system.

**Vintage Mode:** This determines the type of emulation applied to the audio output. You can apply the particular sonic qualities of, for example, the **MPC3000** or **MPC60**, or of course no emulation (**None**).

**Audition Auto Play:** This determines how long a sample will sound when auto-previewing it.

**Audition Outputs:** This determines which pair of outputs will play any auditioned sounds (**Out 1,2-7,8** in Standalone Mode, **Out 1,2-31,32** in Controller Mode; MPC Live/Live II do not use Out 7,8 and MPC One/Key 61/Key 37 do not use Out 3,4-7,8 in Standalone Mode, but displays them to maintain compatibility with MPC X, which does use them). These sounds include: samples, programs, and projects in the Browser; sample playback, **Cue Preview**, and **Slice Preview** in Sample Edit Mode; and sample playback in the **Keep or Discard Sample** window in the Sampler.

**Cue Preview:** This determines if/how audio is played as you move the cue playhead. As you move the cue playhead through a sample waveform, you can set it to play the small part of the sample before the cue playhead (**Before**), play the small part of the sample after the cue playhead (**After**), or not play at all (**Off**). You can also set this in Sample Edit Mode (see [Modes > Sample Edit Mode > Settings](#)).

**Slice Preview:** This determines if/how audio is played as you move a slice marker. As you move the slice marker through a sample waveform, you can set it to play the small part of the sample before the slice marker (**Before**), play the small part of the sample after the slice marker (**After**), or not play at all (**Off**). You can also set this in Sample Edit Mode (see [Modes > Sample Edit Mode > Settings](#)).

**Threads:** This determines how many cores of your computer's processor will be used to render audio. The available range depends on your processor. (For MPC X/Live/Live II/One/Key 61/Key 37, this option is available only when using your MPC hardware in Controller Mode.)

**Audio Warp Algorithm:** This determines how a sample is "warped" when you adjust the length of a sample without changing its pitch (e.g., the **Warp** function in Audio Edit Mode for audio tracks or in Program Edit Mode for clip programs). (For MPC X/Live/Live II/One/Key 61/Key 37, this option is available only when using your MPC hardware in Controller Mode.)

**Note:** The Warp algorithms are very CPU-intensive and can result in audio drop-outs during playback if used too freely. Be mindful of how (and how often) you use the warp function. You can reduce the CPU resources required by using a Warp algorithm other than Elastic Pro, which is very CPU-intensive.

**Audio Track Auto Warp:** This determines how recorded audio track regions are warped. When set to **On**, any audio track region that you record will be warped automatically to match the current sequence tempo. You can then adjust the sequence tempo while the audio track region remains in time.

**Note:** When you record an audio file, the current sequence tempo will be embedded with it. This information is stored within the sample file when you save the project. When you warp an audio track region, the warping algorithm uses this sequence tempo and the current value in the **BPM** field to generate the "stretch factor."

**BPM Detection Range:** This defines the range of detectable BPM values when you use any automatic BPM detection function in the software or when you press the **Tap** button to enter a new tempo.

**Show Q-Link Status When Touched** (MPC Live/Live II/One/Key 61/Key 37/Touch only): When enabled, touching the Q-Link knobs opens a pop-up showing the current Q-Link assignments and values.

**Desktop Screensaver Disable:** This determines if/when your computer's screensaver is disabled while using the MPC software (i.e., using your MPC hardware in Controller Mode):

**Never:** Your computer's screensaver will function normally.

**When hardware used:** As long as your MPC hardware is connected to your computer and being used, your computer's screensaver will be disabled.

**When hardware attached:** As long as your MPC hardware is connected to your computer and powered on, your computer's screensaver will be disabled. It will function normally again if you power off or disconnect your MPC hardware from your computer.

**Always:** Your computer's screensaver will be disabled as long as the MPC software is open (whether or not your MPC hardware is connected or powered on).

(For MPC X/Live/Live II/One/Key 61/Key 37, this option is available only when using your MPC hardware in Controller Mode.)

**Collect Usage Statistics:** This determines whether or not your usage statistics will be sent occasionally to us, enabling us to improve the MPC experience. (For MPC X/Live/Live II/One/Key 61/Key 37, this option is available only when using your MPC hardware in Controller Mode.)

## Splice

The settings on this screen control integration with the Splice platform.

### To access Splice from this page:

1. First, make sure your MPC hardware is connected to a Wi-Fi network. See [Preferences > Wi-Fi](#) to learn how to connect to a wireless network. You will also need access to a web browser.
2. Tap the **Get Login Code** button. (If you are not connected to a network, you will be prompted to do so before the Get Login Code button appears.)
3. Follow the on-screen instructions to link your MPC to your Splice account via a web browser. It may take your MPC a few moments to successfully link.
4. A message will appear on screen when the link has been successfully established. Tap **OK** to continue and return to the Splice Preferences page.
5. Once the process is complete and your MPC has been paired to your Splice account, tap the **Sync Files** button to download samples from your Splice account via Wi-Fi to a drive of your choice.

By default, files will be stored on the Internal drive. You can change the selected drive by tapping the **Change** button under **Sync Files To Drive**.

### To browse samples imported from Splice:

1. Open the **Browser**.
2. Under the **Content** tab, tap the **Splice** shortcut icon to view samples downloaded from your Splice account. If nothing appears, make sure that you have connected your Splice account and synced your files by following the directions [above](#).
3. The right-side of the browser will display your Splice samples organized into a series of top level folders, allowing you to easily browse your sample library by BPM, Instrument, Key, Pack or Tag. The **All Your Samples** folder will show a list of all samples you have downloaded.

**Note:** The original sample files are stored in the **By Pack** folder on your drive. Other folders such as By Instrument contain internal links to help sort the samples by various tags. If the By Pack folder on your drive is deleted, the files in the remaining folders will become unusable. To fully remove all files, the entire Splice directory should be deleted.

**IMPORTANT:** Drives formatted using the FAT32 system do not support these internal links. For these drives, and on the internal storage drives of some earlier MPCs, samples will only be sorted in the **By Pack** folder. We recommend using an exFAT file system on external drives used with MPC, as it is the most robust one supported by both Windows and macOS.

**To view the number of samples available to download from your account,** tap the **Check For Update** button.

**To log out of a Splice account,** tap the **Log Out** button.

## Sync

Tap the **Sync** field (in the center of the top of the screen) and then turn the **data dial** or use the **-/+** buttons to set whether your MPC hardware receives MIDI Clock information (**MIDI Clock**), MIDI Time Code information (**MTC**), communication from **Ableton Link**, or none of these (**Off**). Alternatively, double-tap **Sync** and tap the desired option to select it.

This is the same setting as the **Receive** menu in **Sync** tab of your **Preferences**. See [Preferences > MIDI / Sync](#) for more information.

**Important:** Audio recording is disabled when receiving MIDI Clock sync. Use MIDI Time Code to record audio while receiving MIDI sync.

**Note:** Ableton Link is a new technology that synchronizes beat, phase and tempo of Ableton Live and Ableton Link-enabled applications over a wireless or wired network. Your MPC hardware must be connected to a wireless network to receive this information. See [Preferences > Wi-Fi](#) to learn how to connect to a wireless network.

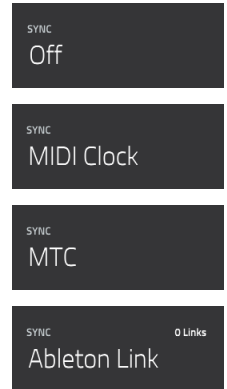

## Undo History

Tap the **clock icon** to open the Undo History window.

The last 10 undoable (and redoable) actions you have performed will appear in this list in sequence. Each action is named in the **Action** column with additional information in the **Detail** column.

Tap the **Undo** button to undo the last action.

Tap the **Redo** button to redo the last action you undid.

The magenta **action marker** indicates the current “undo state” location—the last-performed action.

**To undo or redo multiple actions at once**, click and drag the **action marker** to the desired location in the list. The project will immediately revert to that state. Actions that can be redone (below the action marker) are grayed out.

Tap **Close** or the **X** to close the Undo History window and return to the previous page.

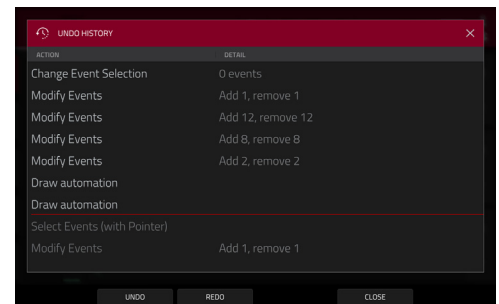
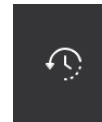

## Tuner

Tap the **tuning fork icon** to open the Tuner window.

- In the window that appears:
  - Use the **Input Channel** field to select the input for the instrument you would like to tune.
  - Use the **Frequency of A** field to set the base tuning frequency.
- Play a note and use the indicator to adjust your instrument to the correct pitch.
- To close the tuner screen, tap **Close**, the **X** in the upper-right corner, or anywhere outside the window.

You can also access the tuner from the [Sampler](#) mode by tapping the **tuning fork icon** at the top of the touchscreen.

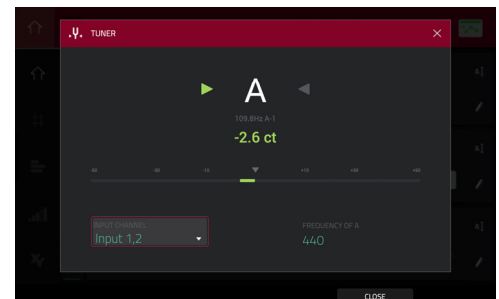

## MIDI Monitor

Tap the **I/O icons** to open the MIDI Monitor window.

The MIDI Monitor popup will display the last 10 MIDI messages sent or received.

Tap **In** to view incoming MIDI messages.

Tap **Out** to view outgoing MIDI messages.

Tap **Clear** to clear the monitor log.

Tap Close or the **X** to close the MIDI monitor and return to the previous page.

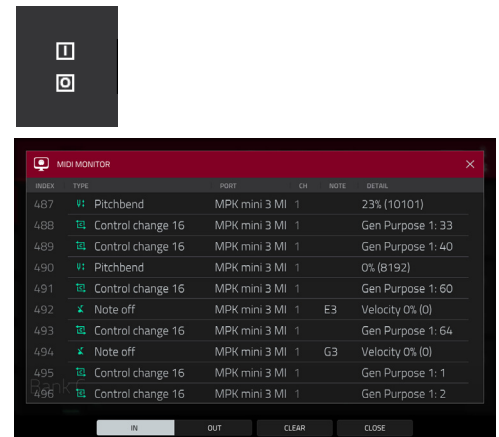

## Mode

Tap this icon to switch MPC X/Live/Live II/One/Key 61/Key 37 between Standalone Mode and Controller Mode (MPC Studio and MPC Touch already operate as a controller only). In the screen that appears, select whether you want to save your current project before switching (**Save**), switch without saving your project (**Don't Save**), or stay in the current mode and project (**Cancel**). You cannot freely switch between Standalone and Controller Modes without also closing your current project.

See [Standalone vs. Controller Mode](#) to learn more.





## System Resources

Tap one of these icons to show the System Resources window for MPC X/Live/Live II/One/Key 61/Key 37.

The indicators in this window show current usage statistics:

**Battery:** If you are using MPC Live powered by its internal battery, the first indicator shows the current **battery life** as a percentage. (See [Battery Usage](#) to learn more about MPC Live and MPC Live II's internal battery.)

**CPU:** The **CPU** indicator shows the current **CPU** as a percentage.

**RAM Usage:** The **Mem** indicator shows your MPC hardware's current RAM usage.



**Important:** If you encounter a warning that there is not enough memory to complete an action while using your MPC hardware, do the following to make more memory available:

Make sure all audio tracks in your project are **not** record-armed.

Delete samples from your project's sample pool that were there before the warning appeared.

If you are still seeing the warning, do the following:

1. **Manually** undo the last action you performed before seeing the warning (you may not be able to use the **Undo** button for this due to how the undo history is stored in RAM).
2. Save your project.
3. Do one of the following, and then load your saved project again.
  - In **Main Mode**, tap the **folder icon** at the top of the screen, and then tap **New** at the bottom of the screen.
  - Power your MPC hardware off and then on again.
  - Press **Menu** and then tap the **gear icon** to open the **Preferences**. In the Preferences, tap **Reset** at the bottom of the screen, tap **OK**, and then tap **Restart** to reset the Preferences.
  - Enter Controller Mode and then reenter Standalone Mode.

**Important:** Although you can load multiple files at once, any samples you load into a project will be automatically converted to full-quality uncompressed audio files, so they may use more storage space than they do on your external storage device. If you are unable to load multiple files at once due to this, select fewer files and try again.

**Drives:** The **Drives** indicator shows the available storage space on any detected external storage devices or the internal drive of MPC X/Live/Live II/One/Key 61/Key 37.

**To delete samples from the project** (to create more free RAM space for sampling time, audio recording, etc.), tap **Purge**. In the screen that appears, tap **Unused Samples** to delete all unused samples from the project, tap **All Samples** to delete all samples from the project (from all programs, sequences, and audio or MIDI tracks), or tap **Cancel** to return to the previous screen.

**To close the System Resources window**, tap **OK**, the **X** in the upper-right corner, or anywhere outside the window.

## Time Counter/Locate

In most of the available modes, there is a time counter at the top of the screen. This indicates the current playhead position.

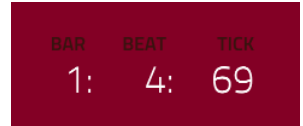

**To adjust the position**, tap it, and then use the **data dial** or the **-/+** buttons.

**To open the Locate screen and adjust its settings**, double-tap the **time counter**.

**To close the Locate screen**, tap the **X** in the upper-right corner or anywhere outside the window.

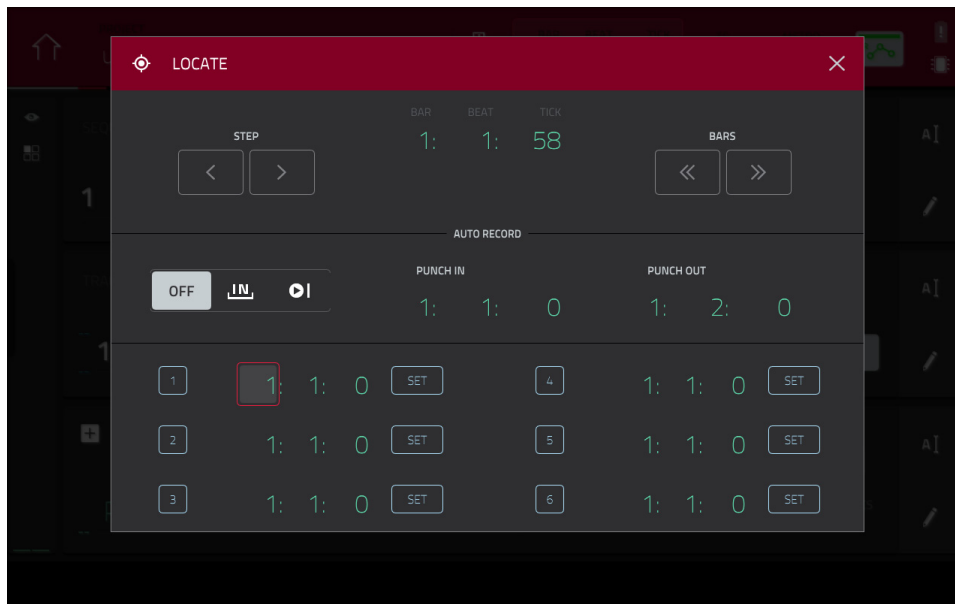

**To move forward or backward a step**, tap the **Step <** or **Step >** button, respectively.

**To move forward or backward a bar**, tap the **Bar <<** or **Bar >>** button, respectively.

**To configure your auto record settings**, use the **Auto Record** selector and adjacent fields:

**Auto Record selector:** Tap the desired option to select it:

**Off:** Auto recording is disabled.

**Punch In:** You can auto record using punch-in and punch-out markers, enabling you to record over a specified length of time in the track. While recording, the entire sequence will play, but you will record over only the area between the **Punch In** and **Punch Out** markers. Any part of the sequence before the Punch In marker or after the Punch Out marker will remain untouched, even if you perform over it during recording.

**Record Start:** After you record-arm the track and start playback, you will start recording once the sequence loops back to its start. This is essentially a punch-in feature for the entire track, enabling you to start playing a record-armed track while allowing more time than the usual count-in to prepare for the actual recording to start.

**Punch In:** Use these fields to set the location of the Punch In marker, which is where recording will start (when the **Auto Record selector** is set to **Punch In**).

**Punch Out:** Use these fields to set the location of the Punch Out marker, which is where recording will stop (when the **Auto Record selector** is set to **Punch In**).

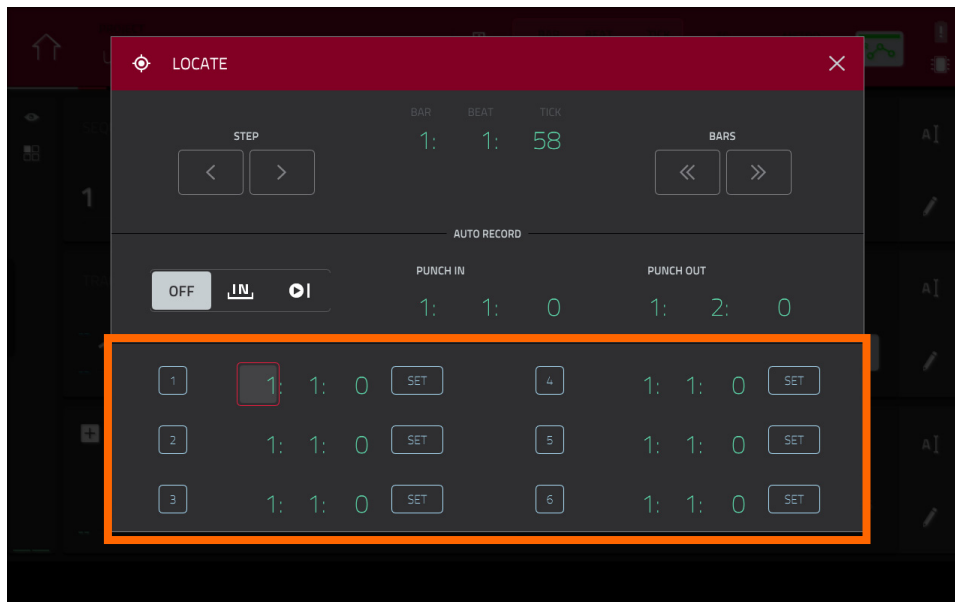

You can use this screen to set time markers, allowing you to jump automatically to precise locations in a sequence. You can set up to six time markers.

**To set a time marker**, tap the **time counter** at the top of the screen, find the desired time, and then tap **Set** next to the desired time marker. The time will appear next to that marker.

**To jump to a time marker**, tap the number next to it (**1–6**).

## Timing Correct (TC)

The **Timing Correct** window contains various settings to help quantize the events in your sequence. You can quantize note events on MIDI tracks or track regions on audio tracks (though you cannot apply all types of quantization to audio tracks).

### To open the Timing Correct settings:

In **Main Mode** or **List Edit Mode**: Tap the **TC** field at the top of the screen.

In the **Grid View**: Press and hold **Shift** and tap **TC** at the bottom of the screen.

In the **Track View** or the **Step Sequencer**: Tap **TC** at the bottom of the screen.

**Note:** The **TC** button in **Pad Mute Mode** and **Track Mute Mode** contain Timing Correct settings, but they do not open this window. See [Modes > Pad Mute Mode](#) and [Track Mute Mode](#) to learn about those settings.

Press the **TC / On/Off** button (MPC Live II/One/Key 61/Key 37/Studio only).

To enable or disable **Global Timing Correct**, tap the **Global Timing Correct** button. Alternatively, press and hold **Shift** and tap the **TC** field at the top of the screen in Main Mode or List Edit Mode.

To apply the settings you selected to the current track, tap **Do It**.

To apply the settings you selected to all tracks, tap **All Tracks**.

To cancel and return to the previous screen, tap **Close**.

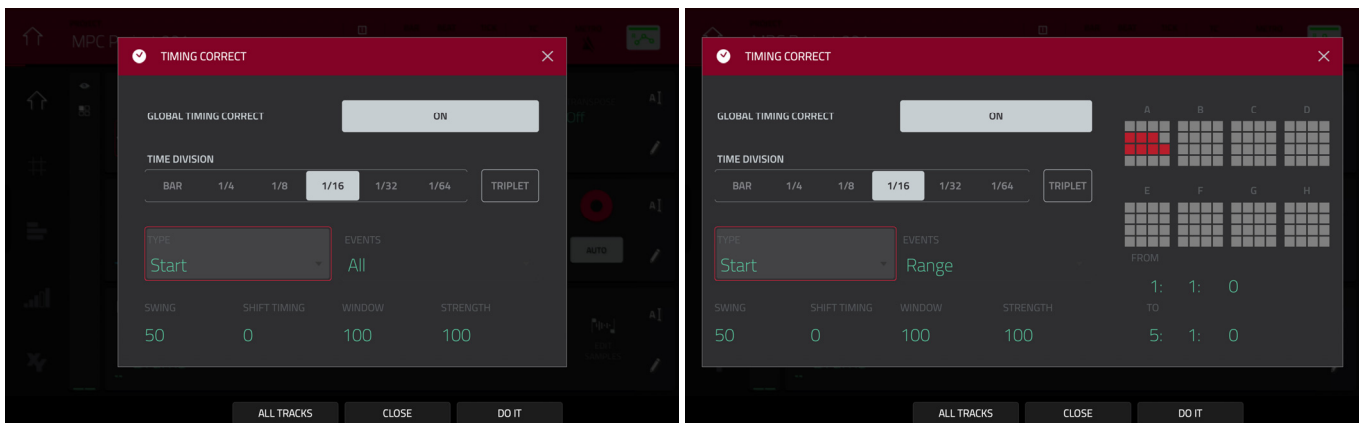

Use the **Type** selector to set how timing corrections are applied.

**Start:** The entire note event or audio track region will be nudged forward or backward so the start point aligns with the closest time division marker in the grid. You can apply this to MIDI tracks or audio tracks.

**End:** The end points of note events will be extended or shortened to align with the closest time division marker in the grid. The start points will remain untouched. You can apply this to MIDI tracks only.

**Length:** The end points of note events will be extended or shortened so that each event's length is a multiple of the time division, regardless of where it is in the grid. The start points will remain untouched. You can apply this to MIDI tracks only.

**Legato:** The end points of note events will be extended or shortened to create a long, unbroken phrase from the first note event's start point to the last note event's end point. Each note event will sustain until another note event starts. If multiple note events start at the same time (and are not the last note events), their lengths will become identical. Selecting **Legato** disables all other options in this window. You can apply this to MIDI tracks only.

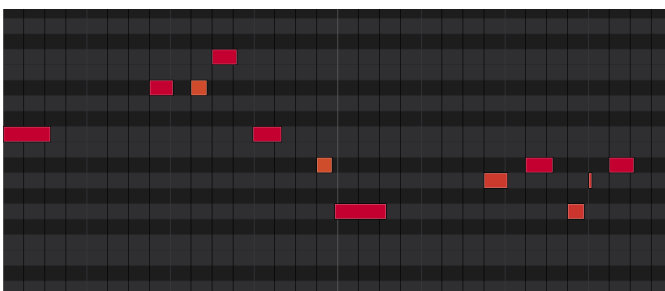

Without legato applied.

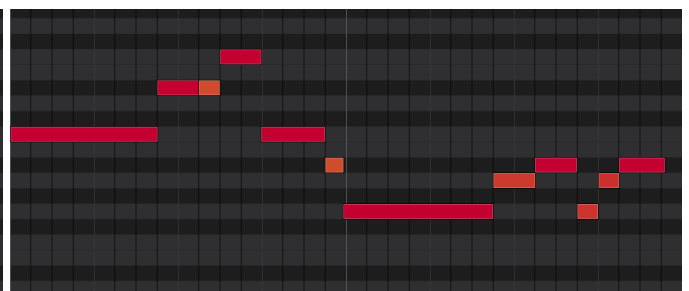

With legato applied.

Use the **Time Division** selector to set the quantization value. Events will “snap” to these time divisions on the grid. The **T** indicates a triplet-based value.

Alternatively, press and hold **Note Repeat** while in Main Mode, and then use the six buttons at the bottom of the screen.

Use the **Swing** field to set the amount of swing from **50%** to **75%**. Swing lets you “shuffle” your beats—from subtle to extreme.

Use the **Shift Timing** field to shift all events by clock ticks.

Use the **Window** field to set how many events around a quantize value will be quantized. Any events outside this range will not be quantized; events inside will.

Use the **Strength** field to set how strictly events will be quantized (i.e., shifted toward the quantize value). Lower values move events a little bit towards the closest quantize value, resulting in a less mechanical feel than a strict quantization (a higher value).

Use the **Events** selector to set the target range for the time correction. You can apply the time correction to **All** note events or to just the **Selected** ones.

To select note events to which to apply time correction, either use the various tools in Grid View or press the pad with the desired events (while **Hitting Pad Selects All Events** is set to **On**). You must do this **before** opening the Timing Correct window.

When **Range** is selected, you can define the locations (**From** and **To**) as well as the pads or keys that will be quantized.

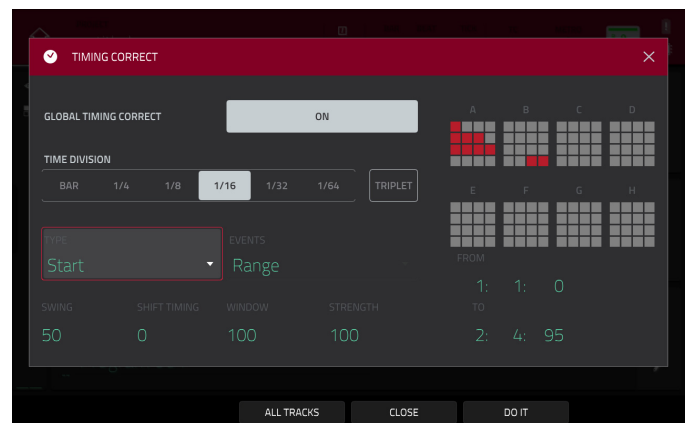

## Metronome (Click/Metro)

The **Click/Metro** window contains all settings regarding the metronome (click track).

### To open the metronome settings:

In **Main Mode** or **List Edit Mode**: Tap the **Metro/metronome icon** at the top of the screen.

In the **Grid View**: Press and hold **Shift** and tap **Click** at the bottom of the screen.

In the **Track View**: Tap **Click** at the bottom of the screen.

Tap the **Metro/metronome icon** at the top of the screen.

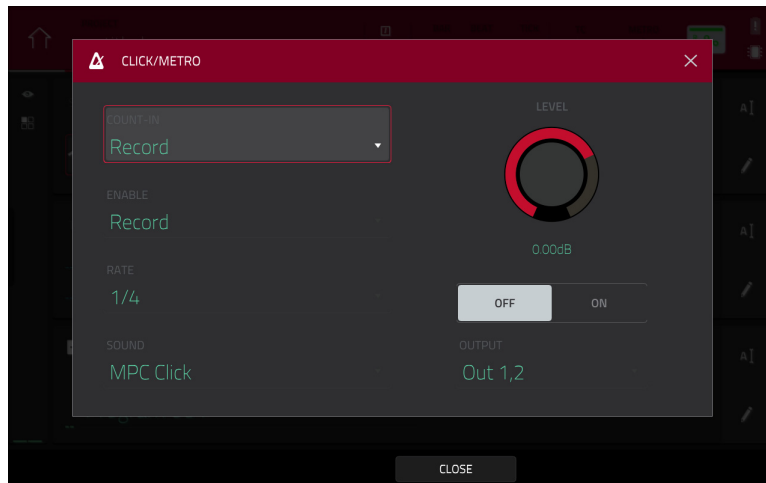

Use the **Count-In** field to set if/when the metronome counts before recording.

**Off** disables the metronome pre-count.

**Record** enables the pre-count during recording only.

**Record + Play** enables pre-count in both Record and Playback Modes.

Use the **Enable** field to set if/when the metronome is enabled.

**Off** disables the metronome.

**Play** enables the metronome sound during playback only.

**Record** enables the metronome sound during recording only.

**Record + Play** enables the metronome to happen in both Record and Playback Modes.

Use the **Rate** field to select the metronome click's time division: **1/4**, **1/4T**, **1/8**, **1/8T**, **1/16**, **1/16T**, **1/32** or **1/32T**. **T** indicates a triplet-based time division.

Use the **Sound** field to select the sound that you want to hear for the metronome: **Sidestick 1**, **Sidestick 2**, **Clap**, **Metroclick**, **Shake**, **Tambourine**, or **MPC Click**.

Use the **Volume** knob to set the volume of your metronome click.

Tap the **On/Off** button to enable or disable the metronome.

Use the **Output** field to set which pair of outputs will play the metronome click: **Out 1,2–7,8** in Standalone Mode, **Out 1,2–31,32** in Controller Mode (MPC Live/Live II do not use Out 7,8, and MPC One/Key 61/Key 37 do not use Out 3,4–7,8 in Standalone Mode, but displays them to maintain compatibility with MPC X, which does use them).

## Automation

You can set the automation for programs and audio tracks to be “written,” “read,” or disabled entirely. You can do this globally or for individual programs and audio tracks.

### Global

In several modes, there is a button in the upper-right corner that controls the global automation. When you tap this button to change its state, it will change the automation state for all programs in the project.

This is available in Main Mode, XYFX Mode, Pad Mute Mode, the Pad Mixer, the Channel Mixer, and Q-Link Edit Mode.

Tap the **global automation button** or press **Automation Read/Write** (MPC Studio) to cycle through its two states:



When set to **Read (R)**, automation data will be read but not recorded. (Think of this as a protective feature to prevent accidental changes to your automation while recording.)

When set to **Write (W)**, automation can be recorded and will overwrite any existing automation. (Make sure not to touch the XY pad accidentally while you are recording.)



Press and hold **Shift** and tap the **global automation button** or press and hold **Shift** and press **Automation Read/Write** (MPC Studio) to disable global automation. When **off**, automation data will be ignored. Tap the **global automation button** again to enable global automation.



**Important:** If you have already recorded automation and turn it off, the track will still use the effect and its parameter values at the point where you turned it off.

### Programs & Audio Tracks

You can also set the automation for each program or audio track by using the program automation button in the channel strip on the left side of the screen in Main Mode and the Channel Mixer. Program automation is available for all program types except MIDI programs.

**Note:** Remember that tapping the global automation button will change the automation state for all programs in the project; if they were originally different, all of them will then match the global automation state.

In Main Mode, if the channel strip is not already shown, tap the small **eye icon** below the **Project** field to show it.

In the Channel Mixer, if you do not see a program automation button in the channel strip, make sure the **Mixer** field is set to **Audio Tracks** or **Programs**.

Tap the **program automation button** to cycle through its two states. Alternatively, press **Read/Write** (MPC X, MPC Key 61) or **Automation** (MPC Key 37).

When set to **Read (R)**, the program will read automation data but will not record any additional automation over it. (Think of this as a protective feature to prevent accidental changes to your automation while recording.)



When set to **Write (W)**, the program can record automation. (If you have any Q-Link knobs assigned to automatable parameters, make sure not to touch any accidentally while you are recording.)



Press and hold **Shift** and tap the **program automation button** to disable program automation. Alternatively, press **Read/Write** (MPC X, MPC Key 61) or **Automation** (MPC Key 37). When **off**, the program will ignore automation data. Tap the **program automation button** (or press **Read/Write** [MPC X, MPC Key 61] or **Automation** [MPC Key 37]) to enable program automation again.



**Important:** If you have already recorded automation and turn it off, the track will still use the effect and its parameter values at the point where you turned it off.

## 16 Level

Press the **16 Level** button on your MPC hardware to activate or deactivate **16 Level**.

When first activated, the selected pad (**Pad A01** by default) will be temporarily copied to all 16 pads. The pads will now output the same note number as the initial pad, but a selectable parameter will be fixed at values that increase as the pad numbers increase (e.g., Pad 1 is the minimum, Pad 16 is the maximum), regardless of how hard you press them.

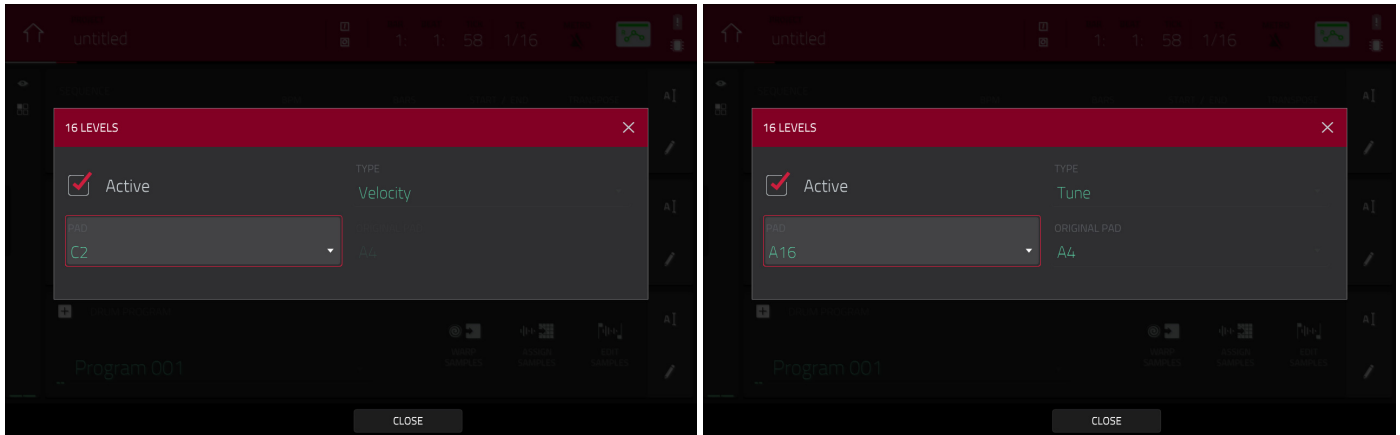

In the **16 Levels** screen that appears, use the **Type** selector to choose the parameter: **Velocity**, **Tune**, **Filter**, **Layer**, **Attack**, **Decay**, **Probability**, or **Ratchet**.

**To select a pad**, do any of the following (while the **16 Levels** window is open):

- Press and hold **16 Level**, and then press the desired **pad**.
- Tap the **16 Levels** checkbox to uncheck it (temporarily disabling the feature), press the desired **pad**, and then tap the **16 Levels** checkbox again to check it.
- Tap the **Pad** field, and use the **data dial** or **-/+** buttons.
- Double-tap the **Pad** field, and tap the desired pad in the list that appears.

If **Type** is set to **Tune**, use the **Original Pad** field to select which pad you want to use the original pitch of the sample/samples. Alternatively, hold **Shift** and press the desired pad.

If **Type** is set to **Layer**, pads with multiple samples will play back each layer according to the **Velocity Start** and **Velocity End** settings for each layer.

If **Type** is set to **Probability**, the 16 pads will represent the probability that the note will play, from lowest to highest.

If **Type** is set to **Ratchet**, the 16 pads will represent increasing ratchet subdivision values.



## Erase

The Erase function erases all or part of a track in a specific sequence.

**To open the Erase window**, press the **Erase** button. Alternatively, while in Main Mode, tap the **pencil icon** on the right edge of the section, and then tap Erase in the screen that appears.

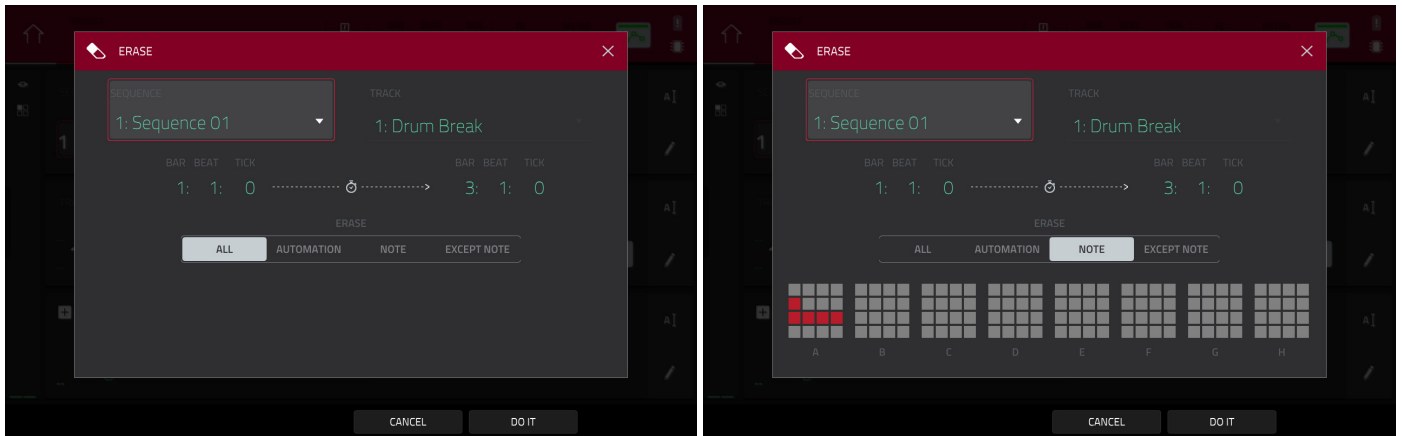

**To select the sequence you want to erase**, use the **Sequence** field.

**To select the track you want to erase within the sequence**, use the **Track** field.

**To set the time range of the sequence you want to erase**, use the **Bar**, **Beat**, and **Tick** fields. The left fields set the start of the time range, and the right fields set the end of the time range.

**To select what types of events you erase**, select one of the **Erase** options:

**All** erases all pad events from the designated time range and reset all of its settings.

**Automation** erases only automation from the designated time range. Use the **Parameter** field to select what type of automation is erased.

**Note** erases only specific pad events from the designated time range. In the diagram of the eight pad banks that appears, press each pad in each bank to select or deselect its notes.

**Except Note** erases everything **except** pad events from the designated time range.

**To confirm your choice**, tap **Do It**.

**To cancel and return to the previous screen**, tap the **X**, **Cancel**, or anywhere outside the window.

## Effects

You can apply various effects to the pads, keygroups, audio tracks, programs, submixes, and main outputs, using **insert** and **send/return** effects. This chapter can help you get a good overall understanding of how the effects work.

See [Appendix > Effects & Parameters](#) for a list of all available effects (with a brief description of each) and their editable parameters.

### Overview

In a program, each **pad** or **keygroup** can have up to **four insert effects** applied to it. See [Insert Effects > Pads](#) or [Keygroups](#) to learn more about this.

An entire **program** or **audio track** can also have up to **four insert effects** applied to it, as well. See [Insert Effects > Programs](#) or [Audio Tracks](#) to learn more about this.

For even further flexibility, each **submix** can have up to **four insert effects** applied to it. You can route pads, keygroups, audio tracks, or programs to a submix, which is then routed to a main output. See [Insert Effects > Submixes](#) to learn more about this.

Additionally, each **pad**, **keygroup**, **audio track**, **program**, and **submix** can each be sent to (up to) **four return channels**, each of which can have up to **four insert effects** of their own. Their audio will be routed through the insert effects on those returns, and the processed audio will be sent to a main output. See [Send/Return Effects](#) to learn more about this.

Finally, you can apply up to **four insert effects** to each main output (a stereo pair of channels: **Outputs 1/2**, **Outputs 3/4**, etc.). See [Insert Effects > Main Outputs](#) to learn more about this.

When you create an audio mixdown of a sequence or song, you can choose whether or not main insert effects are included or send/return effects are included, depending on what you are mixing down:

If you are creating an audio mixdown of a pair of **main outputs**, you can choose whether or not **main insert effects** will be included in the mixdown.

If you are creating an audio mixdown of **separate programs** or **exploded tracks**, you can choose whether or not **send/return effects** will be included in the mixdown.

See [Audio Mixdown](#) to learn about these options.

There are three other modes that handle effects differently:

- The **Sampler** can use up to **four insert effects**, which are applied to the audio as you record it. This means that the effects cannot be “removed” from the sound later. Learn more about the Sampler in the [Modes > Sampler](#) chapter.
- Similarly, the **Looper** can use up to **four insert effects**, which are applied to the audio as you record it. This means that the effects cannot be “removed” from the sound later. Learn more about the Looper in the [Modes > Looper](#) chapter.
- In **XYFX Mode**, the effects act like a single insert effect on that program. In fact, **XYFX** is the name of the insert effect you have to load to the program before you can use this mode. Learn more about XYFX Mode in the [Modes > XYFX Mode](#) chapter.

To view, load, edit, or clear effects, tap the area under the **Inserts** field. This usually appears in a channel strip (next to a **level slider** and **pan knob**).



When viewing loaded effects, you will see this window:

To select an effect, use the field for each insert slot. A window (described below) will appear.

To edit the parameters of a loaded effect, tap the pencil icon next to the insert slot.

To clear the insert slot, tap the trash can icon next to it.

To enable or disable an effect slot, tap the **On/Off** button next to it.

To disable all four effect slots, tap the **All On/All Off** button in the upper-right corner. Tap it again to reactivate the previously active effects.

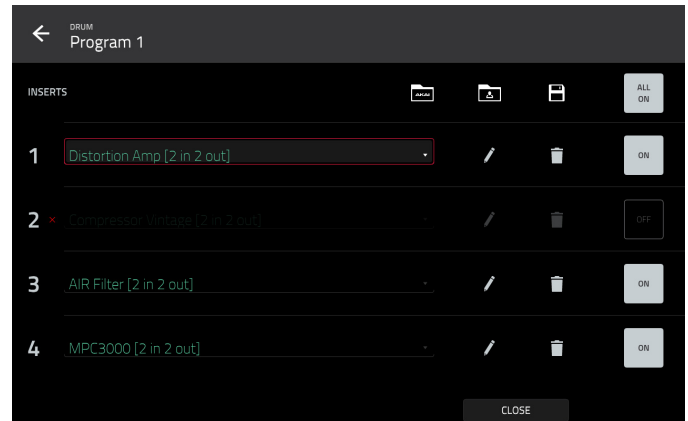

When selecting an effect, you will see this window:

To move through the list, swipe up or down. Alternatively, use the **data dial** or **-/+** buttons.

To sort or unsort the effects by type or manufacturer, tap **Type** or **Manufacturer** in the lower-left corner.

To load an effect, double-tap it. Alternatively, tap **Select**, press the **data dial**, or press the **center cursor** or **Enter** (MPC X).

To cancel, tap **Close** or anywhere outside the list.

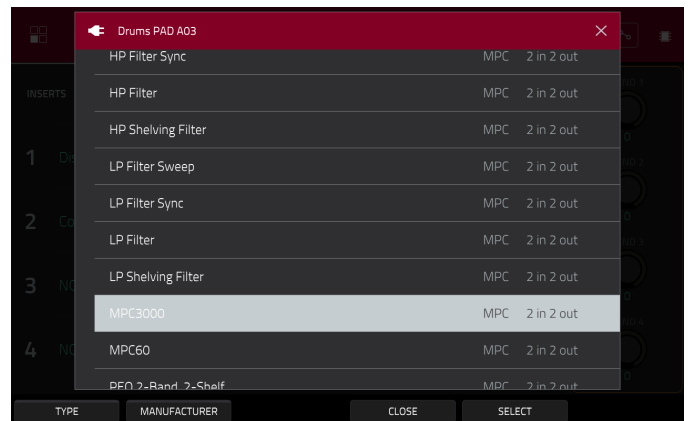

When you edit an effect, you will see this window:

To adjust a parameter, tap and drag its slider. Alternatively, use the **data dial** or **-/+** buttons. To make finer adjustments, double-tap the pad and adjust the larger version of the slider that appears.

**Tip:** Turn the **Q-Link knobs** to quickly adjust the corresponding four parameters.

To select an effect preset, use the dropdown menu at the top of the screen.

To load a saved preset, tap the folder icon at the top of the screen.

To save a preset, tap the disk icon at the top of the screen.

To select another page of parameters, tap the **Parameters -/+** buttons at the top of the screen.

To enable or disable the effect, tap the **On/Off** button in the upper-right corner.

To edit parameters for another insert effect on the same pad, program, etc., tap a different **Insert** tab at the bottom of the screen to select it.

To close the window, tap **Close** or the upper part of the screen.

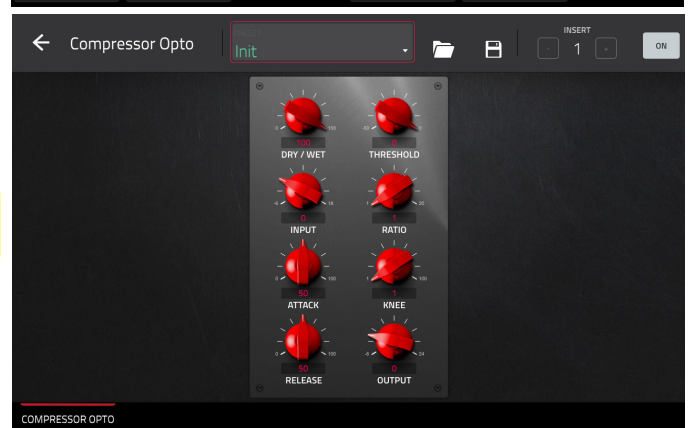

## Insert Effects

### Pads

You can load up to four insert effects to each pad. You can do this in Main Mode, the Pad Mixer, or Program Edit Mode.

**Tip:** When using pad insert effects, they will be applied to the selected pad only. This means that you could apply unique combinations of effects to each pad within a program. If you want to apply the same effect to all pads, do this with a program insert effect (see [Insert Effects > Programs](#)).

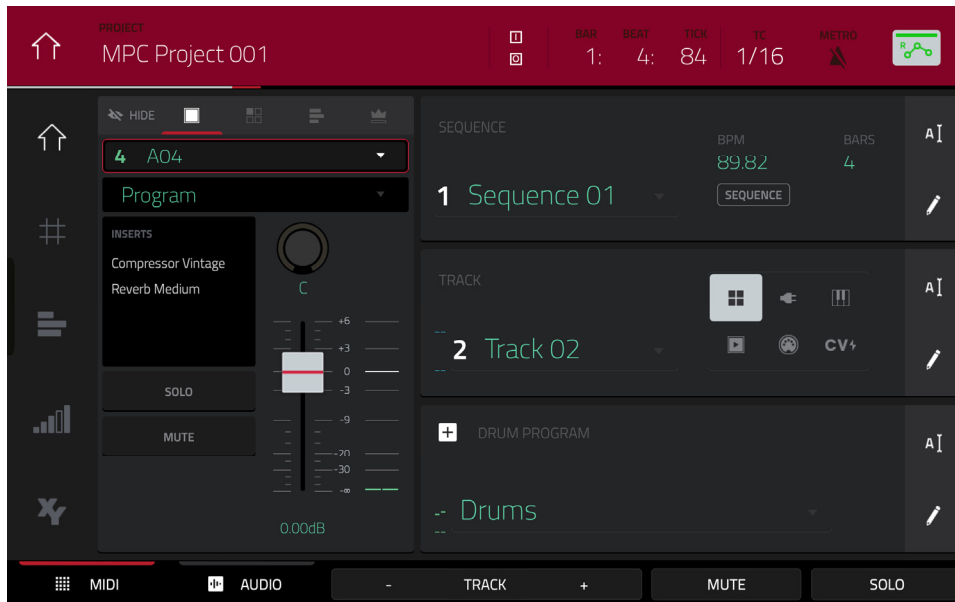

### To load a pad insert effect in Main Mode:

1. When the **MIDI** tab is selected (in the lower-left corner), use the **Track** field to select the track that uses the program with the desired pad—the program it uses will be selected automatically.
2. If the channel strip is not already shown, tap the small **eye icon** below the **Project** field to show it.
3. Tap the **single-pad icon** at the top of the channel strip. The channel strip will now show settings for the current pad.
4. Press the desired **pad** to select it. Alternatively, use the **Pad** field at the top of the channel strip.
5. Tap the area under **Inserts**, and then use the screen that appears to load or edit effects.

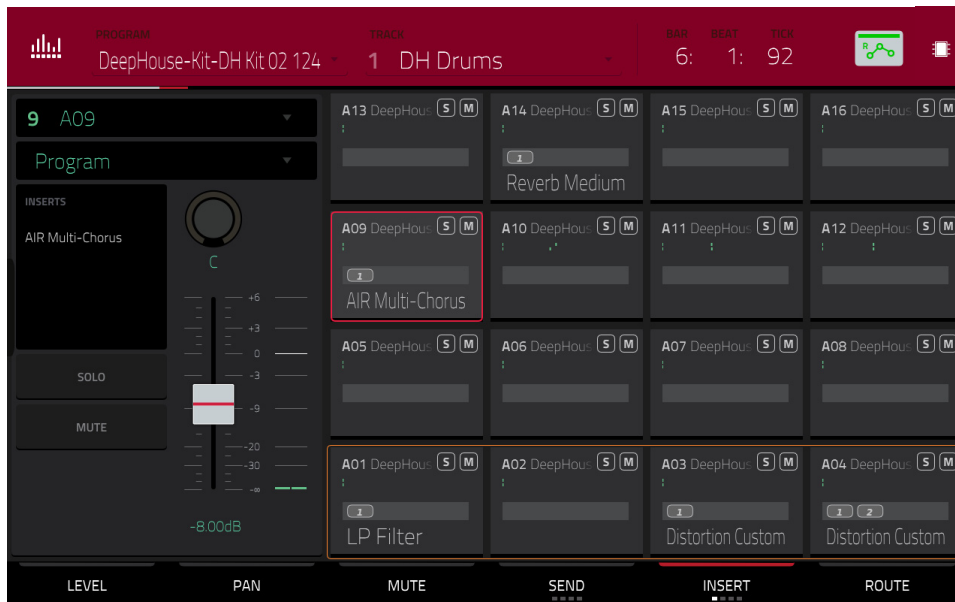

### To load a pad insert effect in the Pad Mixer:

1. Use the **Program** field at the top of the screen to select the desired program. Alternatively, use the **Track** field at the top of the screen to select the desired track—the program it uses will be selected automatically.
2. Press the desired **pad** to select it, or tap it on the screen. Alternatively, double-tap the **Pad** field below the **Program** field.
3. Tap the area under **Inserts**, and then use the screen that appears to load or edit effects. Alternatively, tap the **Insert** tab at the bottom of the screen (tap it multiple times to select a different insert slot), and then double-tap the desired pad on the screen. You could also use the **data dial** or **-/+** buttons to select an effect immediately.

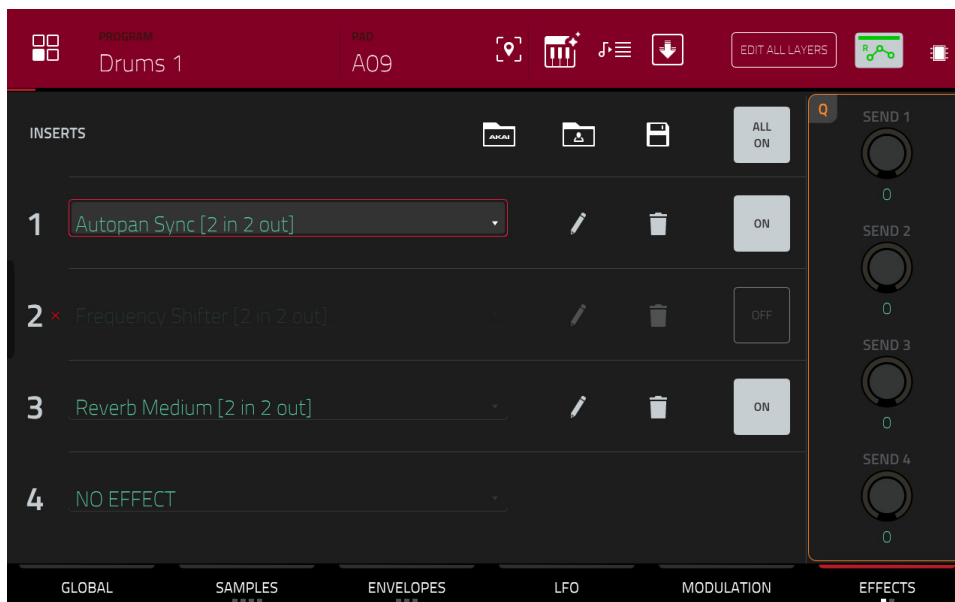

### To load a pad insert effect in Program Edit Mode:

1. While using the desired program, press the desired **pad** to select it.
2. Tap the **Effects** tab in the lower-right corner, and use it to load or edit effects.

## Keygroups

You can load up to four insert effects to each keygroup. You can do this in Main Mode, the Pad Mixer, or Program Edit Mode.

**Important:** When using keygroup insert effects, they will be applied to that keygroup only. Keep this in mind if you load insert effects to multiple keygroups with overlapping note ranges—the effects will overlap in that range as well.

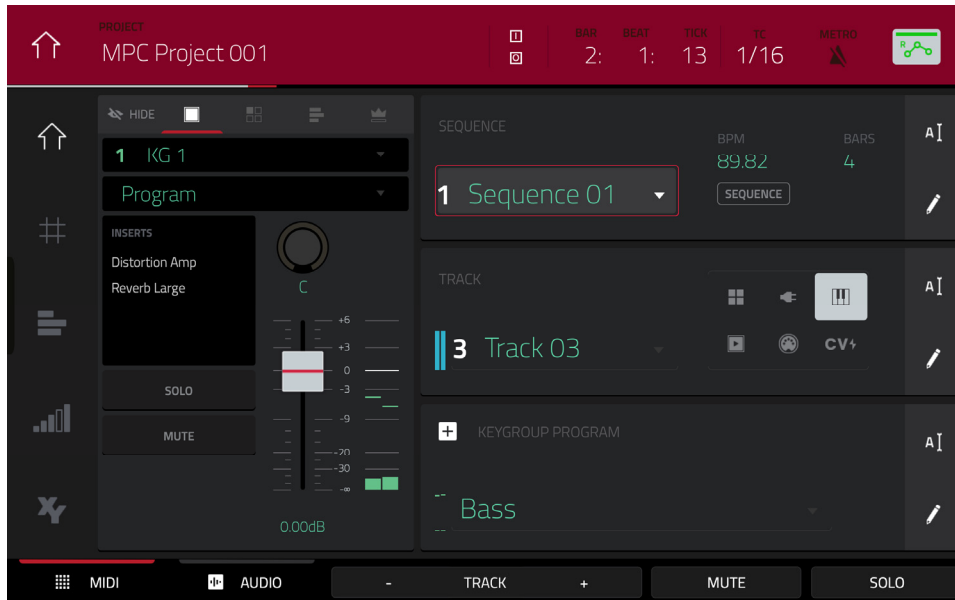

### To load a keygroup insert effect in Main Mode:

1. When the **MIDI** tab is selected (in the lower-left corner), use the **Track** field to select the track that uses the program with the desired pad—the program it uses will be selected automatically.
2. If the channel strip is not already shown, tap the small **eye icon** below the **Project** field to show it.
3. Tap the **single-pad icon** at the top of the channel strip. The channel strip will now show settings for the current keygroup.
4. Press a **pad** to select its corresponding keygroup, or tap it on the screen. Alternatively, use the **Keygroup** field at the top of the channel strip.

**Important:** Remember that the effect will be applied to that keygroup only.

5. Tap the area under **Inserts**, and then use the screen that appears to load or edit effects.

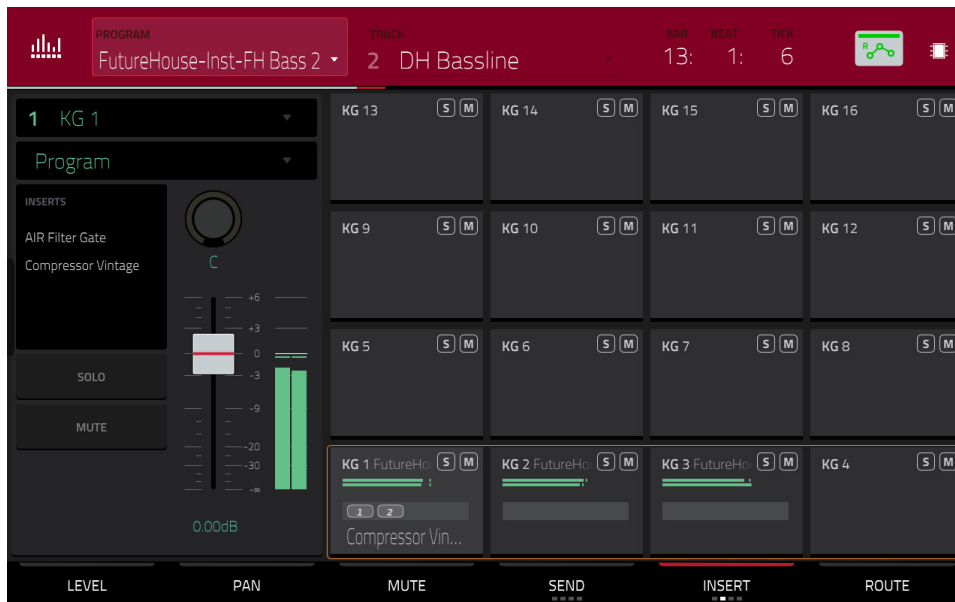

### To load a keygroup insert effect in the Pad Mixer:

1. Use the **Program** field at the top of the screen to select the desired program. Alternatively, use the **Track** field at the top of the screen to select the desired track—the program it uses will be selected automatically.
2. Press a **pad** to select its corresponding keygroup, or tap it on the screen. Alternatively, use the **Keygroup** field below the **Program** field.

**Important:** Remember that the effect will be applied to that keygroup only.

3. Tap the area under **Inserts**, and then use the screen that appears to load or edit effects. Alternatively, double-tap the desired **pad** on the screen. You could also select one of the four **Insert** tabs at the bottom of the screen, and then use the **data dial** or **-/+** buttons to select an effect immediately.

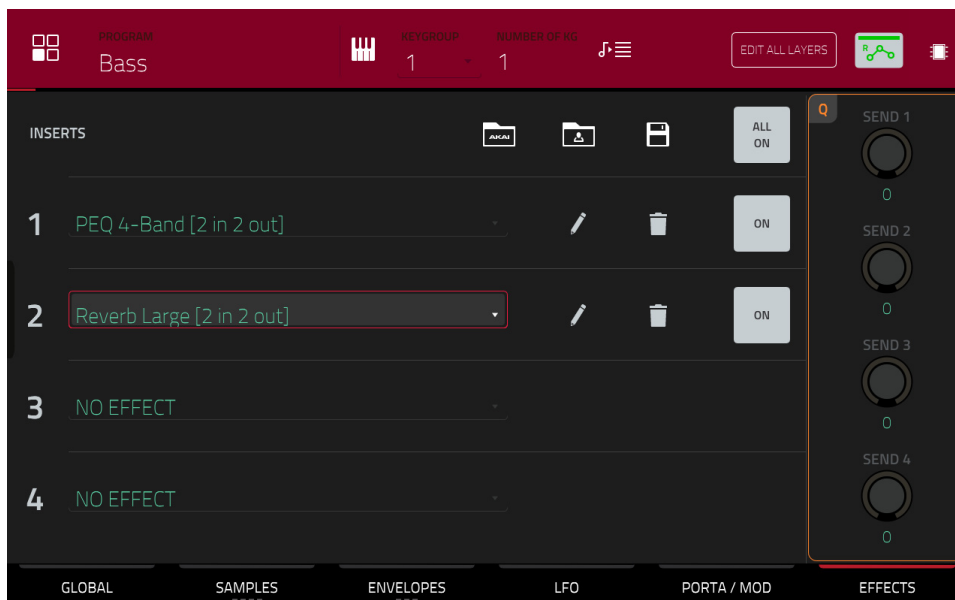

### To load a keygroup insert effect in Program Edit Mode:

1. While using the desired program, press the desired **pad** to select its keygroup. Alternatively, use the **Keygroup** field at the top of the screen.
2. Tap the **Effects** tab in the lower-right corner, and use it to load or edit effects.

## Audio Tracks

You can load up to four insert effects to each audio track. You can do this in Main Mode and the Channel Mixer.

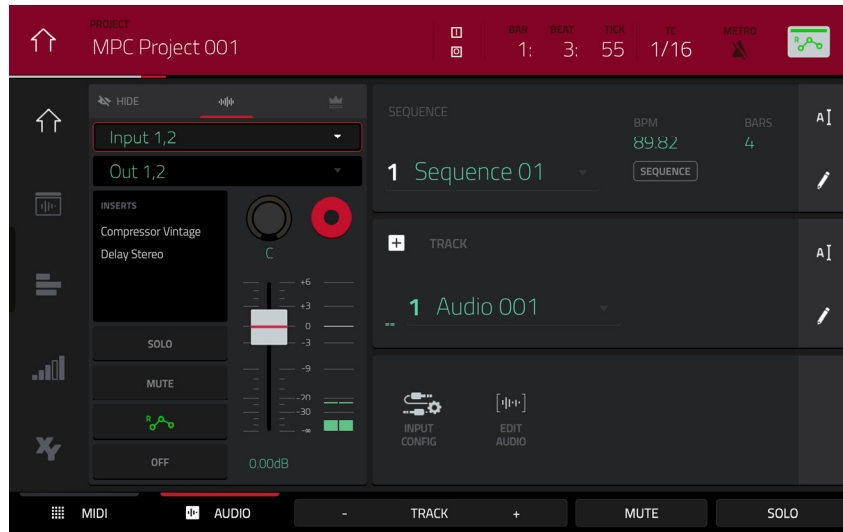

### To load an audio track insert effect in Main Mode:

1. When the **Audio** tab is selected (in the lower-left corner), use the **Track** field to select the audio track.
2. If the channel strip is not already shown, tap the small **eye icon** below the **Project** field to show it.
3. Tap the **waveform icon** at the top of the channel strip. The channel strip will now show settings for the current audio track.
4. Tap the area under **Inserts**, and then use the screen that appears to load or edit effects.

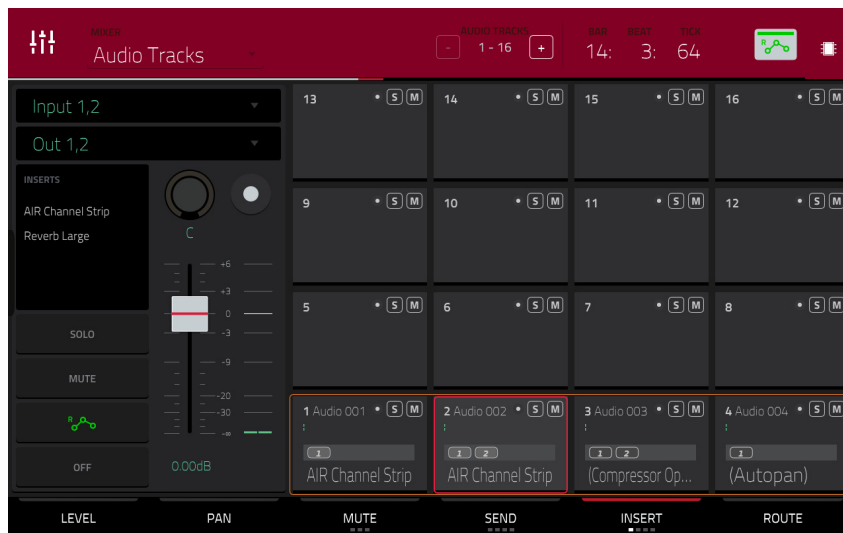

### To load an audio track insert effect in the Channel Mixer:

1. Use the **Mixer** field in the upper-left corner to select **Audio Tracks**.
2. In the touchscreen, tap the **pad** that corresponds to the desired audio track.
3. Tap the area under **Inserts**, and then use the screen that appears to load or edit effects. Alternatively, tap the **Insert** tab at the bottom of the screen (tap it multiple times to select a different insert slot), and then double-tap the desired **pad** on the screen. You could also use the **data dial** or **-/+** buttons to select an effect immediately.



## Programs

You can load up to four insert effects to each program. You can do this in Main Mode, XYFX Mode, and the Channel Mixer.

**Note:** In XYFX Mode, the effects act like a single insert effect on that program. In fact, **XYFX** is the name of the insert effect that is loaded when use this mode.

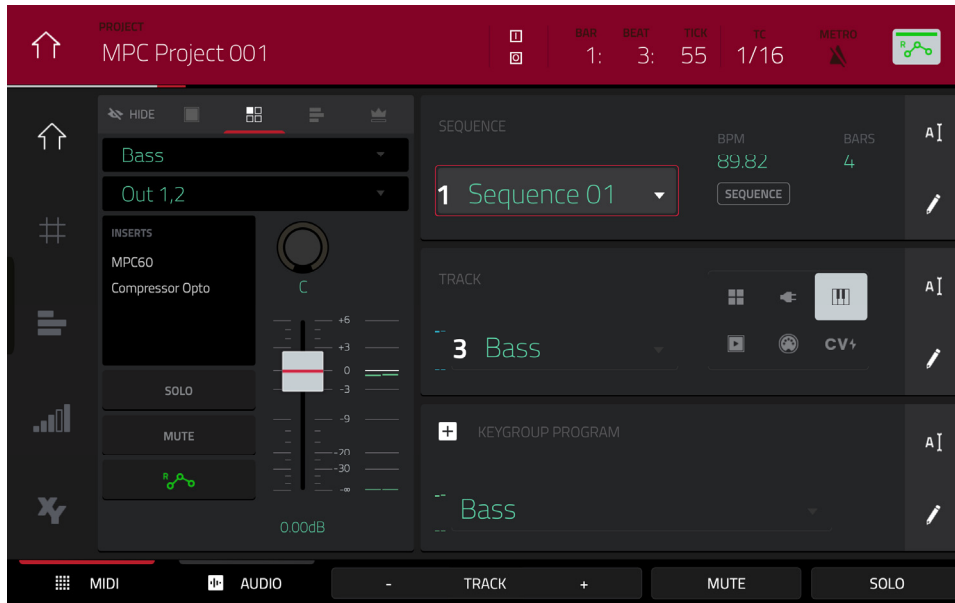

### To load a program insert effect in Main Mode:

1. When the **MIDI** tab is selected (in the lower-left corner), use the **Track** field to select the track that uses the program with the desired pad—the program it uses will be selected automatically.
2. If the channel strip is not already shown, tap the small **eye icon** below the **Project** field to show it.
3. Tap the **four-pads icon** at the top of the channel strip. The channel strip will now show settings for the current program.
4. Tap the area under **Inserts**, and then use the screen that appears to load or edit effects.

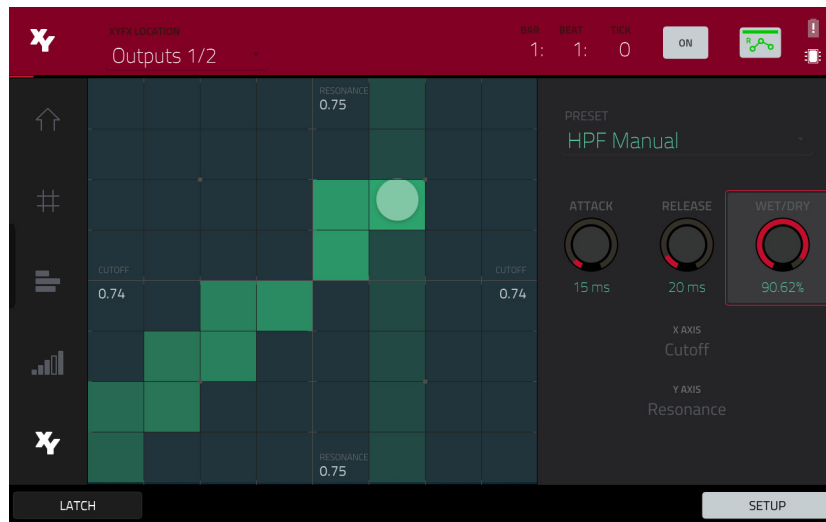

### To load XYFX for a program in XYFX Mode:

1. Select the desired program in another mode, and then enter XYFX Mode.
2. If you have not yet used XYFX Mode for this program, tap **Insert XYFX** on the screen to load it and show the XY pad.

**Note:** If you already have four insert effects loaded, you will need to clear one of the insert effect slots before doing this.

If you have already used XYFX Mode for this program, the XY pad will appear.

3. Tap **XYFX Location** in the upper-left corner, and select **Program**.
4. If the **Setup** panel is not shown, tap **Setup** in the lower-right corner to show it.
5. Use the **Preset** field to load an effect. Use the controls below the **Preset** field to edit the effect.

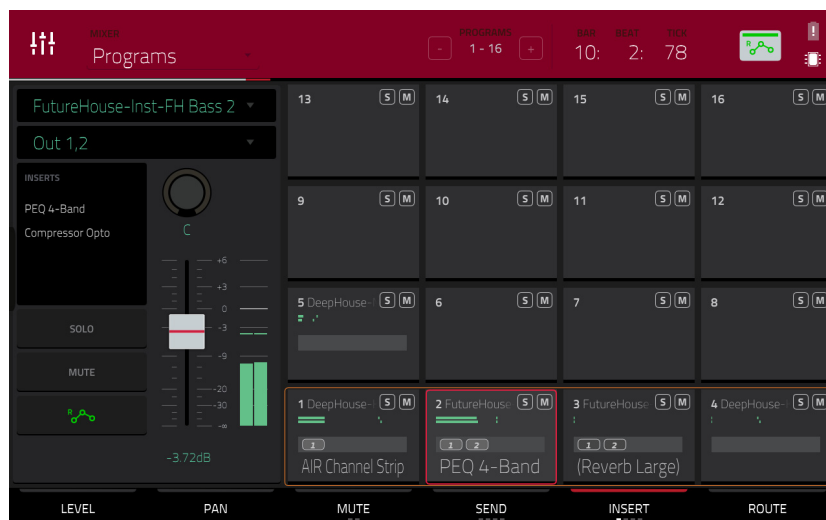

### To load a program insert effect in the Channel Mixer:

1. Use the **Mixer** field in the upper-left corner to select **Programs**.
2. In the touchscreen, tap the **pad** that corresponds to the desired program. Alternatively, double-tap the **Program** field below the **Mixer** field and tap the desired program.
3. Tap the area under **Inserts**, and then use the screen that appears to load or edit effects. Alternatively, tap the **Insert** tab at the bottom of the screen (tap it multiple times to select a different insert slot), and then double-tap the desired **pad** on the screen. You could also use the **data dial** or **-/+** buttons to select an effect immediately.

## Submixes

You can load up to four insert effects to each submix. You can do this in the Channel Mixer only.

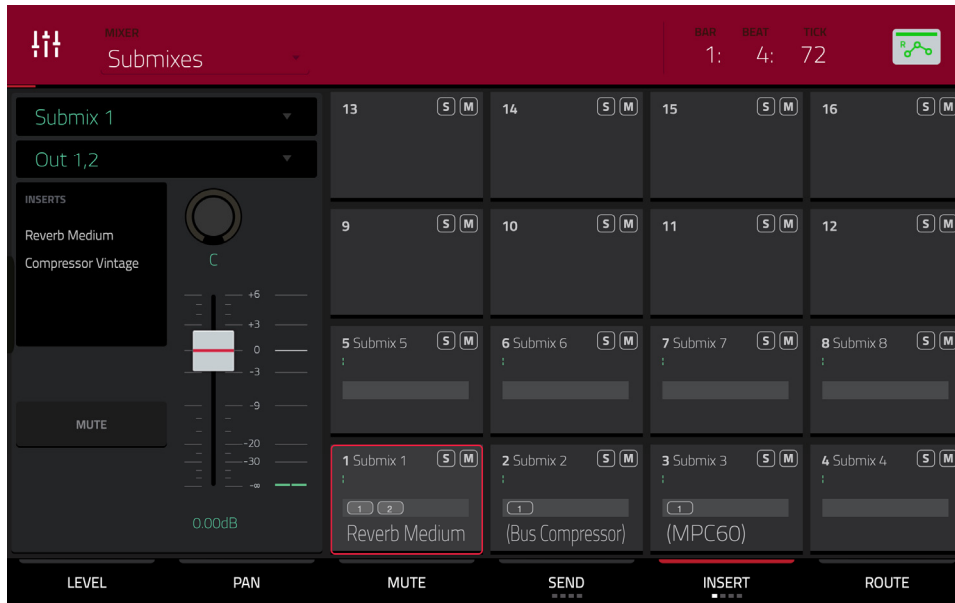

### To load a submix insert effect:

1. Use the **Mixer** field in the upper-left corner to select **Submixes**.
2. In the touchscreen, tap the **pad** that corresponds to the desired program. Alternatively, double-tap the **Submix** field below the **Mixer** field and tap the desired program.
3. Tap the area under **Inserts**, and then use the screen that appears to load or edit effects. Alternatively, tap the **Insert** tab at the bottom of the screen (tap it multiple times to select a different insert slot), and then double-tap the desired **pad** on the screen. You could also use the **data dial** or **-/+** buttons to select an effect immediately.

## Main Outputs

You can load up to four insert effects to each main output (a stereo pair of channels: **Outputs 1/2**, **Outputs 3/4**, etc.). You can do this in Main Mode or the Channel Mixer.

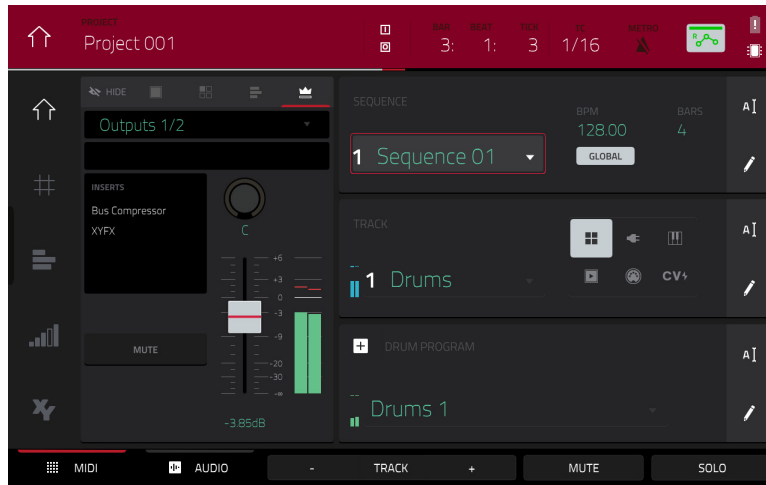

### To load a main output insert effect in Main Mode:

1. If the channel strip is not already shown, tap the small **eye icon** below the **Project** field to show it.
2. Tap the **crown icon** at the top of the channel strip. The channel strip will now show settings for the current main output.
3. Use the **Outputs** field at the top of the channel strip to select the desired main output (**Outputs 1/2**, **Outputs 3/4**, etc.).
4. Tap the area under **Inserts**, and then use the screen that appears to load or edit effects.



### To load a main output insert effect in the Channel Mixer:

1. Use the **Mixer** field in the upper-left corner to select **Main Outputs**.
2. In the touchscreen, tap the **pad** that corresponds to the desired main output (**Outputs 1/2**, **Outputs 3/4**, etc.). Alternatively, double-tap the **Outputs** field below the **Mixer** field.
3. Tap the area under **Inserts**, and then use the screen that appears to load or edit effects. Alternatively, tap the **Insert** tab at the bottom of the screen (tap it multiple times to select a different insert slot), and then double-tap the desired **pad** on the screen. You could also use the **data dial** or **-/+** buttons to select an effect immediately.

## Send/Return Effects

Send/return effects work in the following way:

1. A **pad**, **keygroup**, **audio track**, **program**, or **submix** sends its audio to a **return** at a designated **send level**.
2. That audio is processed by the effects on the return. Each return can have up to **four insert effects** loaded and activated.
3. The processed audio is sent to a pair of main outputs (stereo) or a single main output (mono).

You can load send/return effects and set return levels only in the Channel Mixer, described below. The rest of this section describes the different ways to set the desired send levels for pads, keygroups, programs, or submixes.

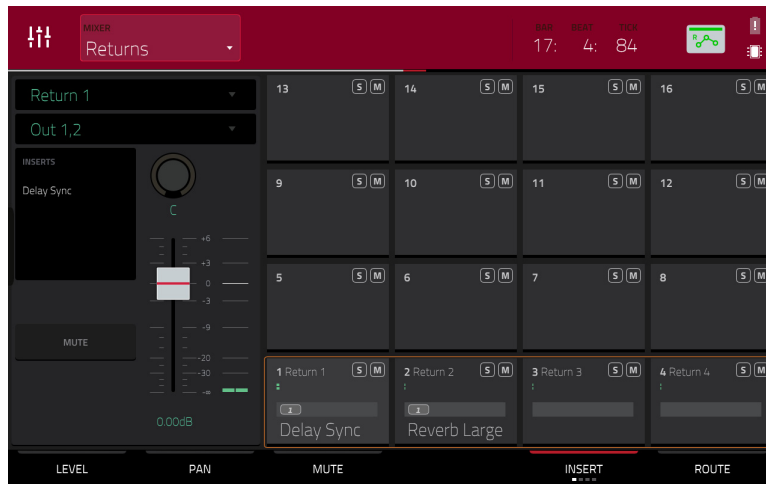

### To load a send/return effect to a return:

1. In the Channel Mixer, use the **Mixer** field in the upper-left corner to select **Returns**.
2. In the touchscreen, tap the **pad** that corresponds to the desired return. Alternatively, double-tap the **Return** field below the **Mixer** field.
3. Tap the area under **Inserts**, and then use the screen that appears to load or edit effects. Alternatively, tap the **Insert** tab at the bottom of the screen (tap it multiple times to select a different insert slot), and then double-tap the desired **pad** on the screen. You could also use the **data dial** or **-/+** buttons to select an effect immediately.



### To set the return level:

1. In the Channel Mixer, use the **Mixer** field in the upper-left corner to select **Returns**.
2. Tap the **Level** tab in the lower-left corner.
3. In the touchscreen, tap the **pad** that corresponds to the desired return. Alternatively, double-tap the **Return** field below the **Mixer** field.
4. **To adjust the level of the currently selected return**, use the **data dial** or **-/+** buttons. Alternatively, use the **level slider** in the channel strip, or turn the corresponding **Q-Link knob**. **To make finer adjustments**, double-tap the **pad** on the screen and adjust the larger version of the slider that appears.

## Pads

You can set the send levels for pads in Program Edit Mode or the Pad Mixer.

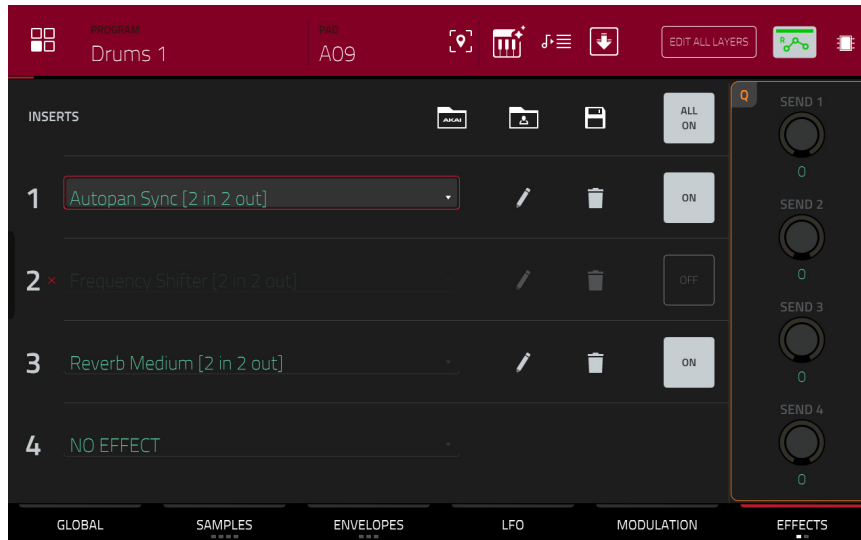

### To set the send levels for a pad in Program Edit Mode:

1. While editing the desired program in Program Edit Mode, press the desired **pad** to select it.
2. Tap the **Effects** tab in the lower-right corner.
3. Use the **Send** knobs to set the send level for each return.



### To set the send levels for a pad in the Pad Mixer:

1. Use the **Program** field at the top of the screen to select the desired program. Alternatively, use the **Track** field at the top of the screen to select the desired track—the program it uses will be selected automatically.
2. Tap the **Send** tab at the bottom of the screen (tap it multiple times to select a different send level).
3. Press the desired **pad** to select it, or tap it on the screen. Alternatively, double-tap the **Pad** field below the **Program** field.
4. **To set the send level**, use the **data dial** or **-/+** buttons. **To make finer adjustments**, double-tap the **pad** on the screen and adjust the larger version of the slider that appears.

## Keygroups

You can set the send levels for keygroups in Program Edit Mode or the Pad Mixer.

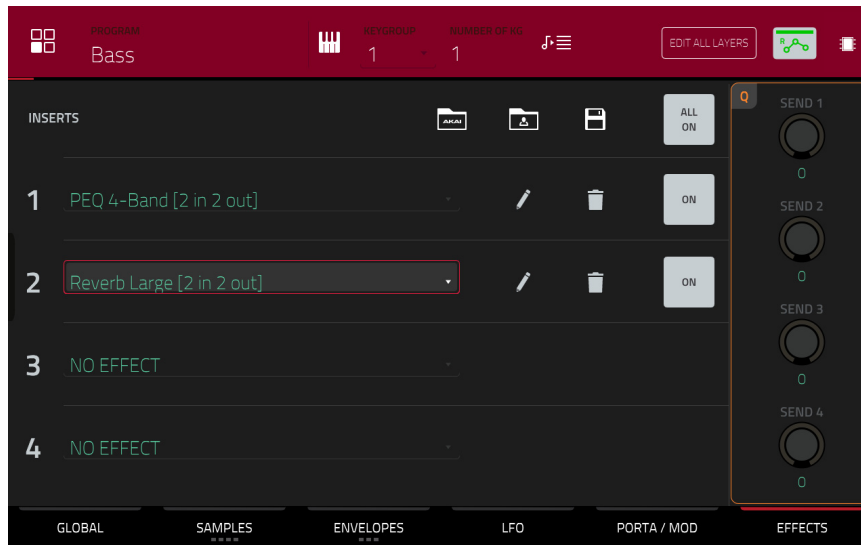

### To set the send levels for a keygroup in Program Edit Mode:

1. While using the desired program, press the desired **pad** to select its keygroup. Alternatively, use the **Keygroup** field at the top of the screen.
2. Tap the **Effects** tab in the lower-right corner.
3. Use the **Send** knobs to set the send level for each return.

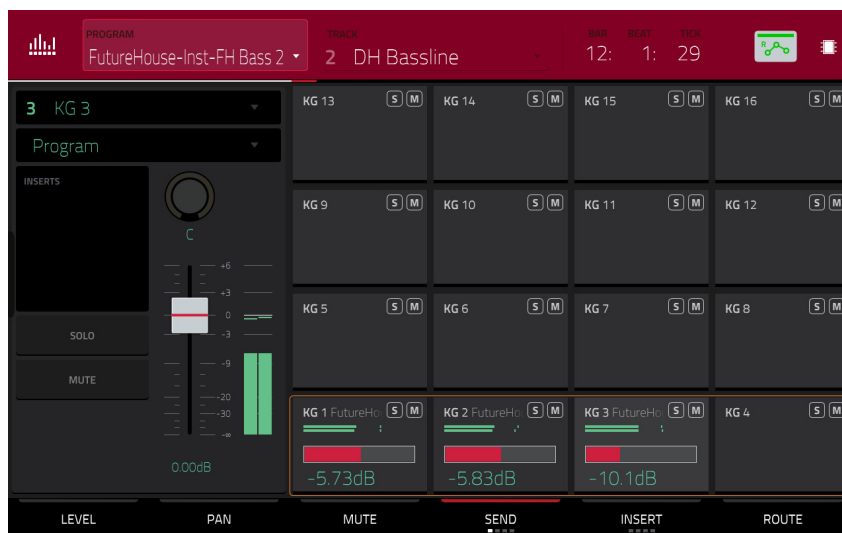

### To set the send levels for a keygroup in the Pad Mixer:

1. Use the **Program** field at the top of the screen to select the desired program. Alternatively, use the **Track** field at the top of the screen to select the desired track—the program it uses will be selected automatically.
2. Tap the **Send** tab at the bottom of the screen (tap it multiple times to select a different send level).
3. Press the desired **pad** to select its corresponding keygroup, or tap it on the screen. Alternatively, double-tap the **Keygroup** field below the **Program** field.
4. **To set the send level**, use the **data dial** or **-/+** buttons. **To make finer adjustments**, double-tap the **pad** on the screen and adjust the larger version of the slider that appears.

## Audio Tracks

You can set the send levels for audio tracks in the Channel Mixer only.

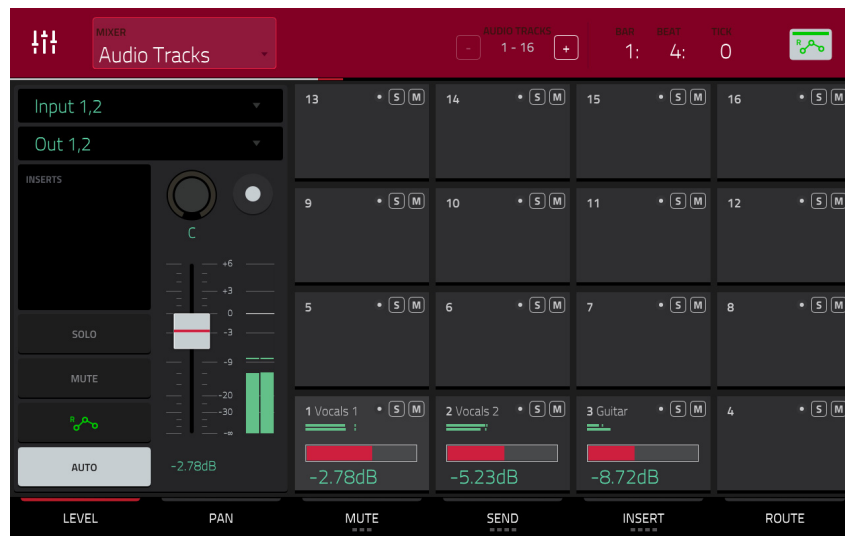

### To set the send levels for an audio track:

1. In the Channel Mixer, use the **Mixer** field in the upper-left corner to select **Audio Tracks**.
2. Tap the **Send** tab at the bottom of the screen (tap it multiple times to select a different send level).
3. In the touchscreen, tap the **pad** that corresponds to the desired audio track. Alternatively, double-tap the **Audio Track** field below the **Mixer** field.
4. **To set the send level**, use the **data dial** or **-/+** buttons. **To make finer adjustments**, double-tap the **pad** on the screen and adjust the larger version of the slider that appears.

## Programs

You can set the send levels for programs in the Channel Mixer only.



### To set the send levels for a program:

1. In the Channel Mixer, use the **Mixer** field in the upper-left corner to select **Programs**.
2. Tap the **Send** tab at the bottom of the screen (tap it multiple times to select a different send level).
3. In the touchscreen, tap the **pad** that corresponds to the desired program. Alternatively, double-tap the **Program** field below the **Mixer** field.
4. **To set the send level**, use the **data dial** or **-/+** buttons. **To make finer adjustments**, double-tap the **pad** on the screen and adjust the larger version of the slider that appears.



## Submixes

You can set the send levels for submixes in the Channel Mixer only.

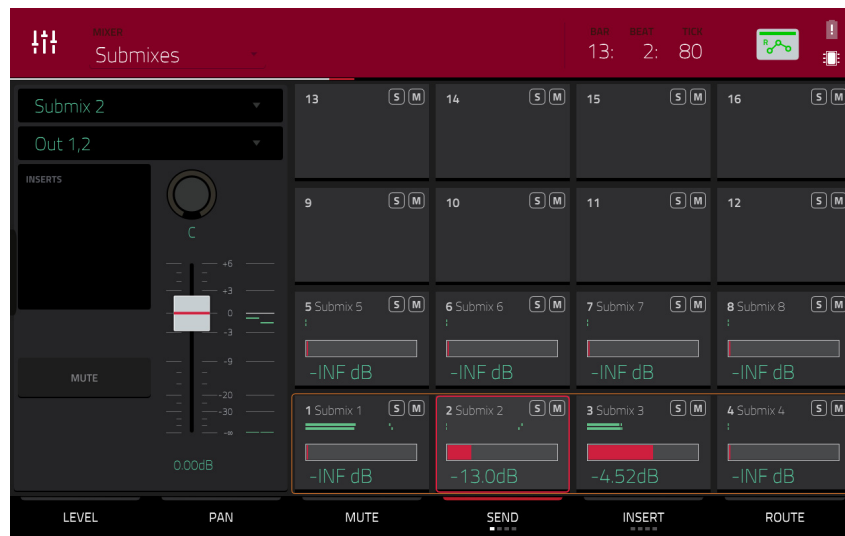

### To set the send levels for a submix:

1. In the Channel Mixer, use the **Mixer** field in the upper-left corner to select **Submixes**.
2. Tap the **Send** tab at the bottom of the screen (tap it multiple times to select a different send level).
3. In the touchscreen, tap the **pad** that corresponds to the desired submix. Alternatively, double-tap the **Submix** field below the **Mixer** field.
4. **To set the send level**, use the **data dial** or **-/+** buttons. **To make finer adjustments**, double-tap the **pad** on the screen and adjust the larger version of the slider that appears.

## Audio Mixdown

The Audio Mixdown screen lets you render and export either the current sequence or song as an audio file. In Song Mode, this will export the entire song. In Main Mode, this will export the current sequence only.

To open the Audio Mixdown screen in Song Mode, tap **Export** at the bottom edge of the screen.

To open the Audio Mixdown screen in Main Mode, tap the **Project** field in the upper-left corner of the screen, and then tap **Export**.

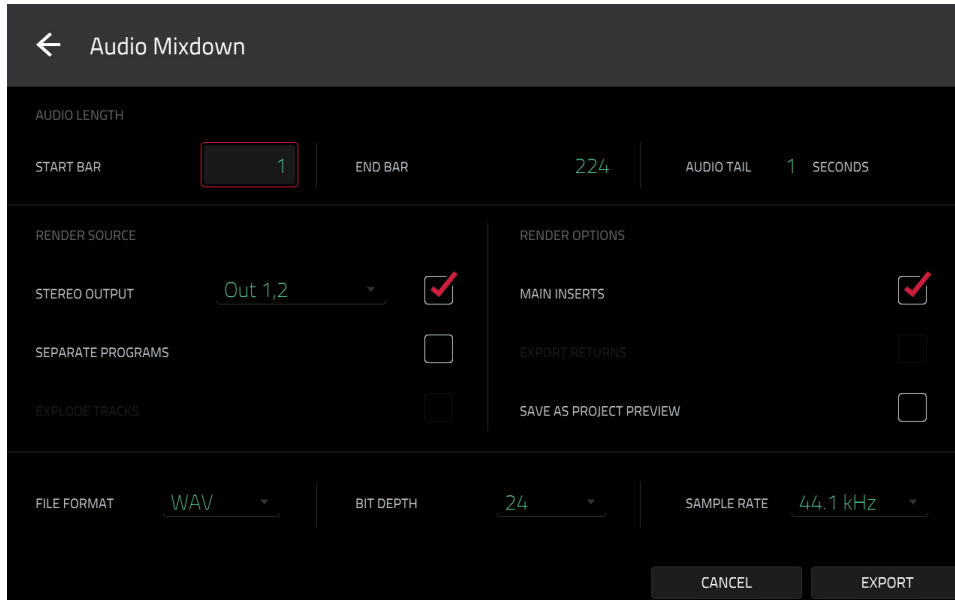

### Audio Length

Use the **Start Bar** and **End Bar** fields to define where the resulting audio file will start and end, respectively.

Use the **Audio Tail** field to add extra seconds to the end of the resulting audio file. This is useful if you are using effects or samples whose sounds exceed the defined audio length (e.g., long reverb or delay, one-shot samples with long decays, etc.). We recommend using an audio tail of at least a couple of seconds.

### Render Source

Check **Stereo Output** and use the adjacent field to select a pair of outputs (**Out 1,2–7,8** and **Submix 1–8** in Standalone Mode, or **Out 1,2–31,32** in Controller Mode. MPC Live/MPC Live II do not use Out 7,8 and MPC One/MPC Key 61/MPC Key 37 do not use Out 3,4–7,8 in Standalone Mode, but displays them to maintain compatibility with MPC X, which does use them). The mixdown will be taken from these outputs.

Check **Separate Programs** to create a mixdown of each program used in the sequence or song.

Check **Explode Tracks** to create a mixdown of each track used in the sequence (you cannot use this option for an entire song).

**Important:** Each pad or keygroup must have their output routed to **Program** to be included in the mixdown. This is the typical (and default) setting. See [Modes > Pad Mixer > Routing](#) to learn about this.

### Render Options

If your **Render Source** is set to **Stereo Output**, check **Main Inserts** to include main insert effects in the mixdown.

If your **Render Source** is set to **Separate Programs** or **Explode Tracks**, check **Export Returns** to export the return channel signals as separate files.

If your **Render Source** is set to **Stereo Output**, tap **Save as Project Preview** to save the sequence or song as a project preview file (which you can play for reference in the Browser). If you check this box, **Stereo Output** will automatically be checked, as well.

## File Formats

Tap **WAV**, **AIFF**, **MP3**, **FLAC**, or **OGG** to select the file format of the mixdown.

For **WAV** and **AIFF** files, use the **Bit Depth** field to select a bit depth of **8**, **16**, or **24** bits, or **32** bits, floating point (**32 F**). For **FLAC** files, you can select a bit depth of **16** or **24** bits. For **MP3** and **OGG** files, you can select a **Bitrate** of **128**, **160**, **192**, or **320** kbps.

Use the **Sample Rate** field to select a sample rate of **44.1 kHz**, **48 kHz**, **88.2 kHz**, or **96 kHz**. In most cases, we recommend selecting **44.1 kHz**.

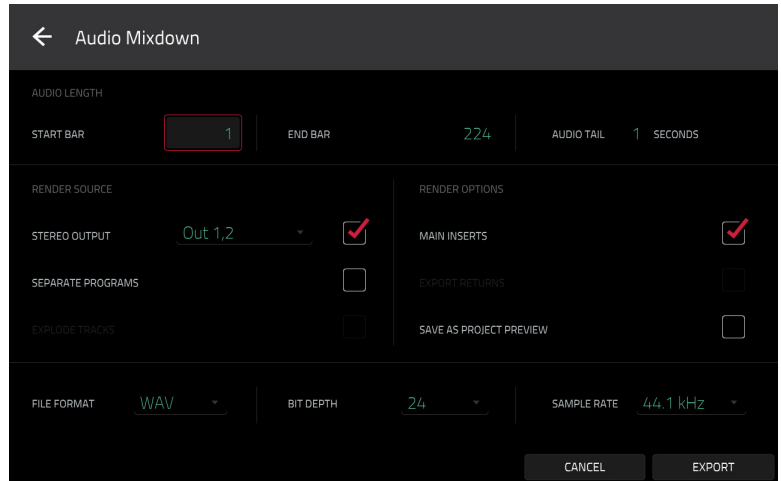

Tap **Export** to enter the **Save** screen where you can select a name and location to save your audio mixdown.

Tap **Cancel** or the **← icon** in the upper-left corner to return to the previous screen.

## Battery Usage

**Important:** Only MPC Live and MPC Live II may use battery power. MPC X, MPC One, MPC Key 61, MPC Key 37, and MPC Touch must be connected to a power outlet. MPC Studio operates on USB power only.

Although you can power MPC Live and MPC Live II from a power outlet (using the included power adapter), you can use its internal battery, which typically has four hours of life, depending on CPU and how you're using MPC Live or MPC Live II.

While powering MPC Live from its internal battery, the **battery icon** in upper-right corner of the touchscreen will show its current battery life. (The icon below it indicates whether MPC Live or MPC Live II is in Standalone Mode or Controller Mode.)



**To view MPC Live's system resources** (battery life, CPU, and RAM usage), tap the **battery icon** in upper-right corner of the touchscreen. The System Resources window will appear, showing percentages to indicate the current battery life, CPU, RAM usage (**Mem**), and storage device space usage.

See [System Resources](#) to learn more about the information shown in this window.

**To charge MPC Live or MPC Live II's internal battery**, connect its **power input** to a power outlet using the included power adapter. The **charging indicator** light (behind the vent on the rear panel) will turn on while charging. When the battery is fully charged or when it is disconnected from a power outlet, then this light will turn off.

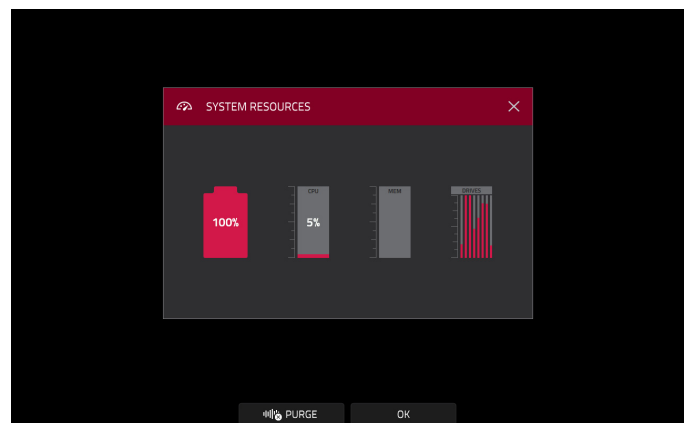

## Standalone vs. Controller Mode

MPC X, MPC Live, MPC Live II, MPC One, MPC Key 61, and MPC Key 37 can function in two ways: **Standalone Mode** and **Controller Mode**. (MPC Studio and MPC Touch already operate as a controller only.)

To enter **Standalone Mode**, do one of the following:

- If MPC X/Live/Live II/One/Key 61/Key 37 is **not** connected to a computer, simply press the **power switch** to power it on.
- If MPC X/Live/Live II/One/Key 61/Key 37 is connected to your computer and you want to keep your MPC software open, press **Menu**, and then tap the **monitor/cable icon** in the upper-right corner. When the **Switch to Standalone Mode** window appears, tap **Standalone** to continue. Your project will remain open on your computer, and you can continue to work on it independently from the project shown on the screen. (If you tap **Cancel**, you can continue using your MPC hardware in Controller Mode.)
- If MPC X/Live/Live II/One/Key 61/Key 37 is connected to your computer and you want to close the MPC software, simply close the MPC software on your computer. When **Looking for computer** appears on your MPC hardware's touchscreen, tap **Standalone**. If the **Restart as Standalone** window appears, tap **Yes** to continue. (If you tap **Cancel**, you can reopen your MPC software and continue using your MPC hardware in Controller Mode.)

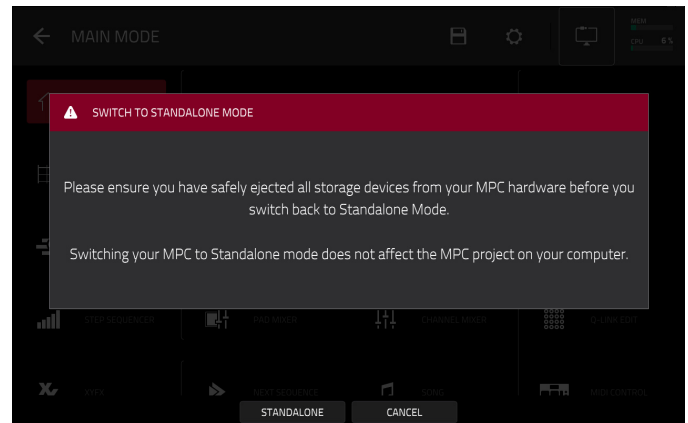

In Standalone Mode:

- An **MPC chip icon** will appear in the upper-right corner.
- The MPC hardware is **not** communicating with a computer over a USB connection.
- Any files (projects, samples, etc.) that you save or load are in the internal hard drive on your MPC X/Live/Live II/One/Key 61/Key 37, or a connected USB drive or SD card.
- Plugin programs are disabled.



**To enter Controller Mode:**

1. Make sure the **USB-B Port** on your MPC X/Live/Live II/One/Key 61/Key 37 is connected to your computer.
2. On your computer, open the MPC software.
3. If MPC X/Live/Live II/One/Key 61/Key 37 is powered off, press the **power switch** to power it on.
4. If MPC X/Live/Live II/One/Key 61/Key 37 is currently in Standalone Mode, press **Menu** to enter the Menu, and then tap the **MPC chip icon** in the upper-right corner. When the **Enter Controller Mode** window appears, tap **Controller Mode** to continue. (If you tap **Cancel**, you can continue using your MPC hardware in Standalone Mode.) **Looking for computer** may appear briefly on the screen before the MPC hardware recognizes the USB connection as a controller.

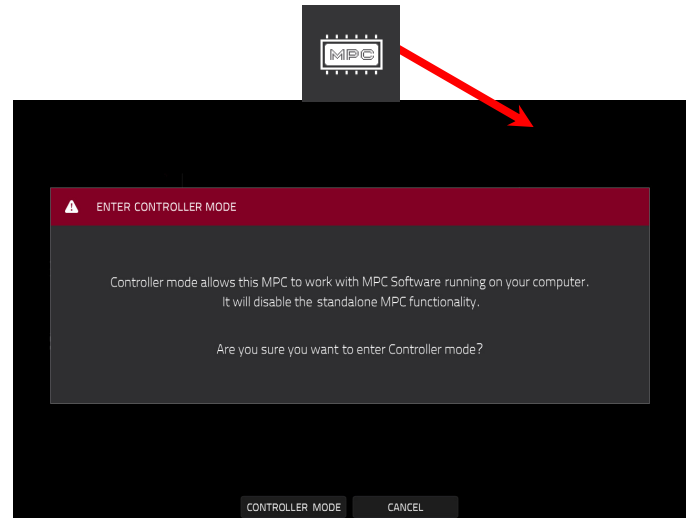
**In Controller Mode:**

- A **monitor/cable icon** will appear in the upper-right corner.
- The MPC hardware is communicating with a computer over a USB connection.
- You can save or load files (projects, samples, etc.) to or from your computer as well as the internal hard drive on your MPC X/Live/Live II/One/Key 61/Key 37 or a connected USB drive or SD card.
- Plugin programs are enabled. Remember to specify the disk directory where your plugins are located. This can be done in the software's **Preferences** (in the **Edit** Menu). See the user guide in the MPC software to learn more: click the **Help** menu, select **MPC Help**, and select **MPC User Manual**.
- The touchscreen on your MPC hardware reflects what it is controlling in the software, but due to space and character limitations, the layout on the screen is different (e.g., parameter names may be abbreviated, the layout may be different or spread across multiple tabs, etc.).



## Modes

The MPC hardware has a Menu page that lets you select any one of several modes. This chapter describes the various features and functions of each one.

Click a button below to skip directly to that chapter.

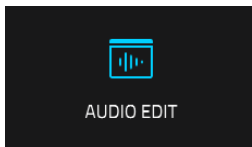
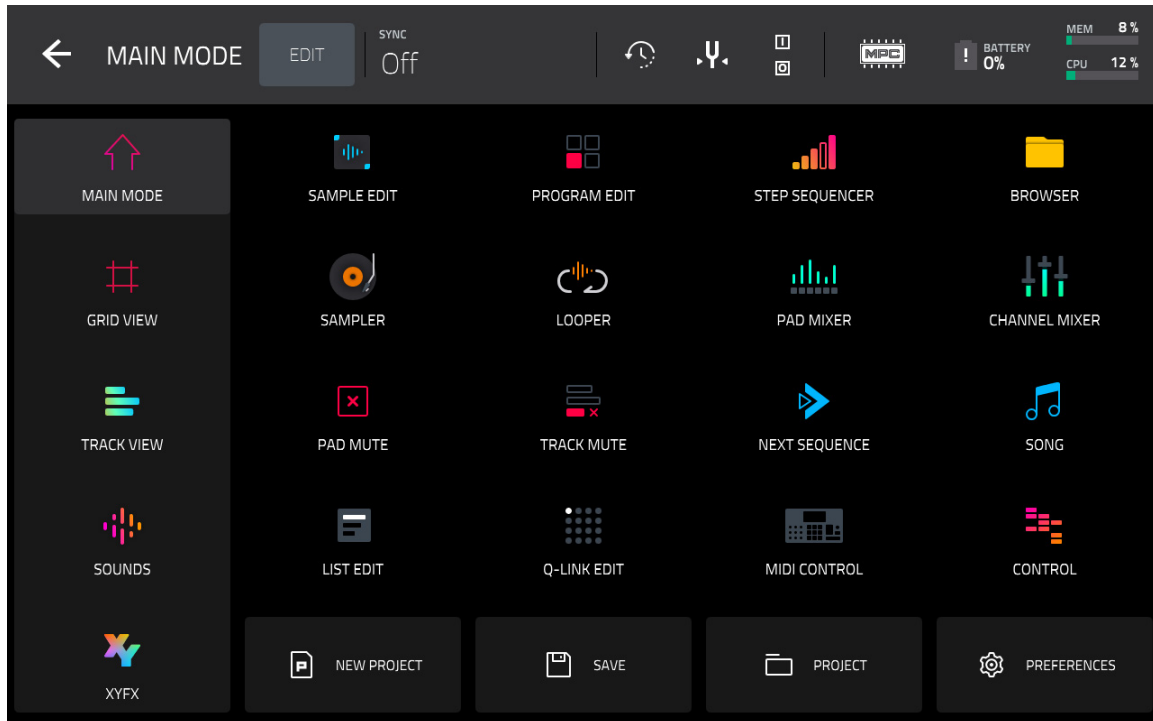

**Note:** The Menu above is available when the currently selected track is a MIDI track. When an audio track is selected, it will show an icon for [Audio Edit Mode](#) instead of Grid View.



While in **Main Mode**, the **Grid View**, **Audio Edit Mode**, the **Track View**, the **Step Sequencer**, or **XYFX Mode**, the left edge contains icons to quickly enter one of five modes. Using this strip of icons, you can easily jump between them:

**To enter Main Mode**, tap the **house icon**.

**To enter the Grid View**, tap the **grid icon**. The **MIDI** tab in the lower-left corner of the screen in Main Mode must be selected for this icon to be shown.

**To enter Audio Edit Mode**, tap the **waveform-and-box icon**. This **Audio** tab in the lower-left corner of the screen in Main Mode must be selected for this icon to be shown.

**To enter the Track View**, tap the **bars-and-magnifying-glass icon**.

**To enter the Step Sequencer**, tap the **vertical-bars icon**.

**To enter XYFX Mode**, tap the **XY icon**.

You can also edit the Menu layout by tapping the **Edit** button. Once enabled, tap and drag the menu icons to your preferred location, and then tap **Edit** again to save your changes. This is useful for putting your most-used modes in the left-most column so that they are easily accessed in any mode by swiping to the right from the left edge of the touchscreen. See [Addenda > Updates in MPC 2.11 > New Features > Menu Editing and Shortcuts Panel](#) for more information.

## Main Mode

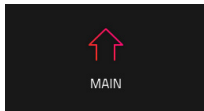

Main Mode gives you an overview of the most-used functions.

To enter Main Mode, do one of the following:

- Press **Main**.
- Press **Menu**, and then tap **Main**.

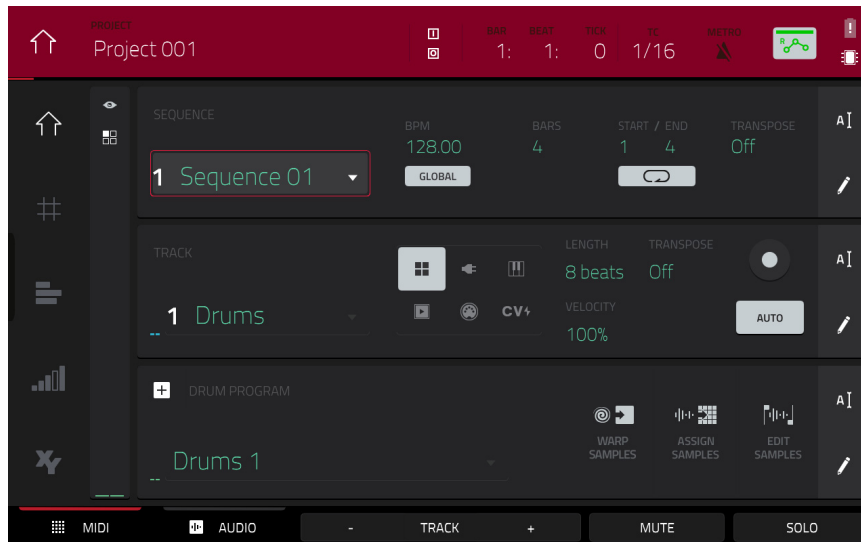

The top of the screen shows the project name and timing information.



The **Project** field shows the name of the current project.

To view the **Project window**, tap the **Project** field. The Project window will appear, showing a list of available programs, sequences, and samples in the project.

In the **Project** window, in addition to typical functions you can perform in lists, you can do any of the following:

**To move through a list**, swipe up or down.

**To expand or collapse the list of programs or sequences**, tap the arrow (v or >) to its left.

**To select a program, sequence, or sample**, tap it.

**To immediately select a sample and enter Sample Edit Mode**, double-tap it.

**To save the project**, tap **Save**.

**To save the project with another name**, tap **Save As**. Use the **Save** window that appears to save the project.

**To return to the previous screen**, tap the **X** in the upper-right corner or anywhere outside the window.

**To delete samples from the project** (to create more free RAM space for sampling time, audio recording, etc.), tap **Purge**. In the screen that appears, tap **Unused Samples** to delete all unused samples from the project, tap **All Samples** to delete all samples from the project (from all programs, sequences, and audio or MIDI tracks), or tap **Cancel** to return to the previous screen.

**To export the current sequence**, tap **Export**. Use the **Audio Mixdown** screen that appears to export a song (see [General Features > Audio Mixdown](#) to learn about the settings in this window). To export the song instead, see the [Song Mode](#) chapter.

**To export the current sequence as an Ableton Live Set**, tap **ALS Export**. See [Addenda > Updates in MPC 2.6 > New Features > Ableton Live Set Export](#) for more information.



The **In** and **Out** boxes indicate your MPC hardware is receiving or sending (respectively) MIDI messages from or to your computer. Tap here to open the **MIDI Monitor** and view the latest incoming or outgoing MIDI messages. See [Operation > Menu > MIDI Monitor](#) for more information.

The time counter at the top of the screen the current playhead position. This is shown in most of the modes. See [General Features > Time Counter/Locate](#) to learn about this.

The **TC icon** opens the **Timing Correct** window, which contains various settings to help quantize the note events in your sequence. See [General Features > Timing Correct \(TC\)](#) to learn about this.

Press and hold **Shift** and tap the **TC icon** to enable or disable global timing correct.

The **Metro/metronome icon** opens the **Click/Metro** menu, which contains all settings regarding the metronome (click track). See [General Features > Metronome \(Click/Metro\)](#) to learn about this.

Press and hold **Shift** and tap the **Metro/metronome icon** to enable or disable the metronome.

The automation button indicates the global automation state. This is shown in several modes. See [General Features > Automation](#) to learn about this.

In Main Mode, these are the buttons at the bottom of the screen:

**MIDI:** Tap this button to view only MIDI tracks in the **Track** section.

**Audio:** Tap this button to view only audio tracks in the **Track** section.

**Track -/+:** Tap one of these buttons to switch to the previous or next track, respectively.

**Mute:** Tap this button to mute the current track.

**Solo:** Tap this button to solo the current track.



On the left edge of the screen, next to the five mode icons, there are two small icons that control the channel strip.

**To show or hide the channel strip,** tap the **eye icon**.

The icon below the eye icon indicates the type of channel strip (see next description).



The channel strip contains some important settings for the current pad, program, track, or main output, depending on the currently selected icon:

**To view the pad channel strip,** tap the **single-pad icon**.

**To view the program channel strip,** tap the **four-squares icon**.

**To view the track channel strip,** tap the **bars icon** (when the **MIDI** tab is selected) or the **waveform icon** (when the **Audio** tab is selected).

**To view the main channel strip,** tap the **crown icon**.

When viewing the **pad channel strip** while using a drum program, keygroup program, or clip program:

The first field shows the current pad number. Press a pad or tap the field to select a different pad.

**Tip:** This is useful for mixing your pads without having to enter the Pad Mixer.

The second field shows where the pad is routed, which you can change: **Program** (the usual setting); **Out 1,2-7,8**, **Out 1-8** or **Sub 1-8** in Standalone Mode; and **Out 1,2-31,32** or **Out 1-32** in Controller Mode.

**Note:** When set to a mono channel, the left and right channels are summed post-pan knob. If the pan knob is set to the center position, the left and right channels will be summed and padded. If the pan knob is set to the maximum left or right positions, only the respective channel will be sent to the output.

The **Inserts** field shows any enabled or disabled effects for that pad. Tap the area under **Inserts** to open a window where you can load, change, and enable or disable the effects.

Tap **Solo** or **Mute** to solo or mute the pad (respectively).

Adjust the **pan knob** or **level slider** to change the panning or level of the pad. The **green** level meter next to the slider shows the pad's current volume level in **dB**.

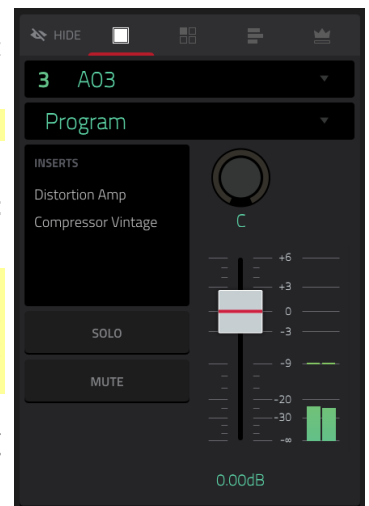

When viewing the **program channel strip** while using a drum program, keygroup program, clip program, or plugin program:

The first field shows the current program number and name (which you can change).

The second field shows where the program is routed, which you can change: **Out 1,2-7,8**, **Out 1-8** or **Sub 1-8** in Standalone Mode (depending on the hardware used); and **Out 1,2-31,32** or **Out 1-32** in Controller Mode.

**Note:** When set to a mono channel, the left and right channels are summed post-pan knob. If the pan knob is set to the center position, the left and right channels will be summed and padded. If the pan knob is set to the maximum left or right positions, only the respective channel will be sent to the output.

The **Inserts** field shows any enabled or disabled effects for that program. Tap the area under **Inserts** to open a window where you can load, change, and enable or disable the effects.

Tap **Solo** or **Mute** to solo or mute the program (respectively). Alternatively, press **Solo** or **Mute** under the LED meters (MPC X).

**To change the program's automation**, tap the **program automation button** to toggle between the two states. Alternatively, press **Read/Write** (MPC X, MPC Key 61) or **Automation** (MPC Key 37).

When set to **Read (R)**, the program will read automation data but will not record any additional automation over it. (Think of this as a protective feature to prevent accidental changes to your automation while recording.)

When set to **Write (W)**, the program can record automation. (If you have any Q-Link knobs assigned to automatable parameters, make sure not to touch any accidentally while you are recording.)

Hold **Shift** and tap the **program automation button** to disable program automation. Alternatively, press **Shift+Read/Write** (MPC X, MPC Key 61) or **Shift+Automation** (MPC Key 37). When **off**, the program will ignore automation data. If you have already recorded or entered automation, tapping this will switch between **Read (R)** and **Write (W)** only, but you can override this and turn it off by pressing and holding **Shift** while tapping the button.

**Important:** If you have already recorded automation and turn it off, the track will still use the effect and its parameter values at the point where you turned it off.

**Tip:** You can quickly set all programs and audio tracks to the same automation by tapping the global automation button in the upper-right corner of the screen. See [General Features > Automation](#) to learn about this.

Adjust the **pan knob** or **level slider** to change the panning or level of the program. The **green** level meter next to the slider shows the program's current volume level in **dB**.

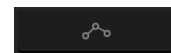
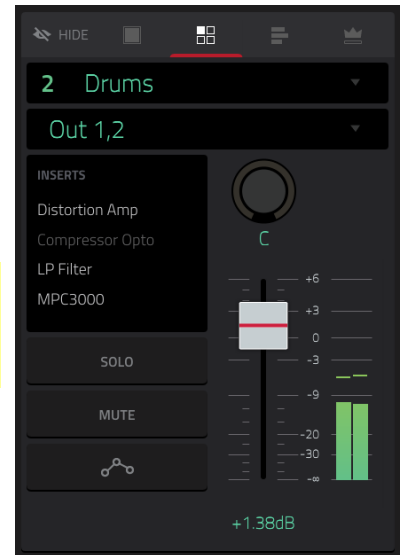

When viewing the **track channel strip** while using a MIDI track:

The first field shows the current track (which you can change) and its name.

The second field shows the name of the program the track is using.

Use the MIDI fields to configure the MIDI settings for the track. See [Addenda > Updates in MPC 2.8 > New Features > MIDI Improvements](#) to learn about this.

Tap **Solo** or **Mute** to solo or mute the track (respectively).

Tap the **Monitor** button to change the monitor behavior for the track.

Adjust the **pan knob** or **level slider** to change the panning or level of the track. The **blue** level meter next to the slider shows the track's current velocity level.

**Note:** If the track is using a plugin program, then the slider will send **CC #7 (Volume)** and the knob will send **CC #10 (Pan)** to your instrument plugin. The plugin will then handle these messages as it normally would.

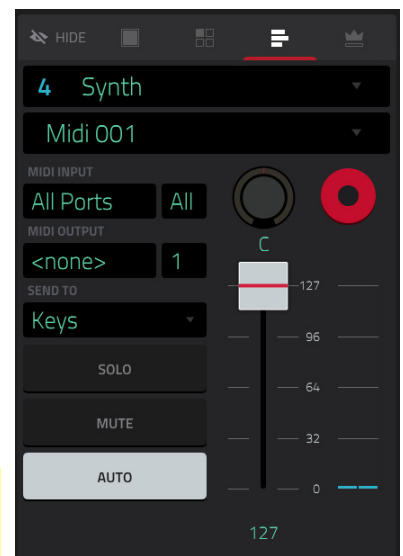

When viewing the **track channel strip** while using an audio track:

The first field defines the input source of the external audio signal, which you can set to a pair of inputs (**Input 1,2–3,4** in Standalone Mode, **Input 1,2–31,32** in Controller Mode) or a single input (**Input 1–4** in Standalone Mode, **Input 1–32** in Controller Mode).

The second field shows where the track is routed, which you can change: **Out 1,2–7,8**, **Out 1–8** or **Sub 1–8** in Standalone Mode (depending on the hardware used); and **Out 1,2–31,32** or **Out 1–32** in Controller Mode.

**Note:** When set to a mono channel, the left and right channels are summed post-pan knob. If the pan knob is set to the center position, the left and right channels will be summed and padded. If the pan knob is set to the maximum left or right positions, only the respective channel will be sent to the output.

The **Inserts** field shows any enabled or disabled effects for that track. Tap the area under **Inserts** to open a window where you can load, change, and enable or disable the effects.

Tap **Solo** or **Mute** to solo or mute the track (respectively). Alternatively, press **Solo** or **Mute** under the LED meters (MPC X).

**To change the audio track's automation**, tap the **track automation button** to toggle between the two states. Alternatively, press **Read/Write** (MPC X, MPC Key 61) or **Automation** (MPC Key 37).

When set to **Read (R)**, the audio track will read automation data but will not record any additional automation over it. (Think of this as a protective feature to prevent accidental changes to your automation while recording.)

When set to **Write (W)**, the audio track can record automation. (If you have any Q-Link knobs assigned to automatable parameters, make sure not to touch any accidentally while you are recording.)

Hold **Shift** and tap the **track automation button** to disable audio track automation. Alternatively, press **Shift+Read/Write** (MPC X, MPC Key 61) or **Shift+Automation** (MPC Key 37). When **off**, the audio track will ignore automation data. If you have already recorded or entered automation, tapping this will switch between Read (**R**) and Write (**W**) only, but you can override this and turn it off by pressing and holding **Shift** while pressing or tapping the button.

**Important:** If you have already recorded automation and turn it off, the track will still use the effect and its parameter values at the point where you turned it off.

**Tip:** You can quickly set all programs and audio tracks to the same automation by tapping the global automation button in the upper-right corner of the screen. See [General Features > Automation](#) to learn about this.

Tap the **Monitor** button to change the monitor behavior for the track.

Adjust the **pan knob** or **level slider** to change the panning or level of the track. The **green** level meter next to the slider shows the track's current volume level in **dB**.

**To record-enable the track**, tap the **Record Arm** button or press **Rec Arm** (MPC X). When you begin audio recording, the audio signal will be recorded to this track.

**Tip:** You can select multiple tracks in the Track View by pressing and holding **Shift** while tapping the **Arm** button to each track.

When viewing the **main channel strip**:

The first field shows the current main output as a stereo pair (which you can change).

The **Inserts** field shows any enabled or disabled effects for that pair of outputs. Tap the area under **Inserts** to open a window where you can load, change, and enable or disable the effects.

Tap **Mute** to mute the main output.

Adjust the **pan knob** or **level slider** to change the panning or level of the main output. The **green** level meter next to the slider shows the outputs' current volume level in **dB**.

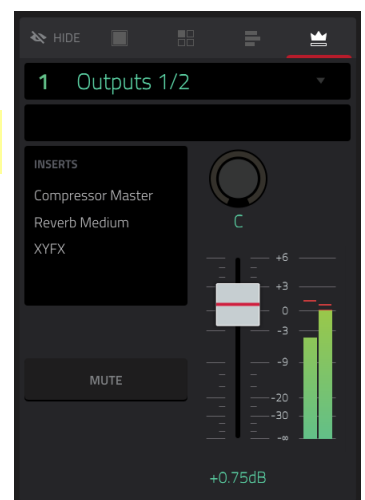
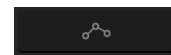
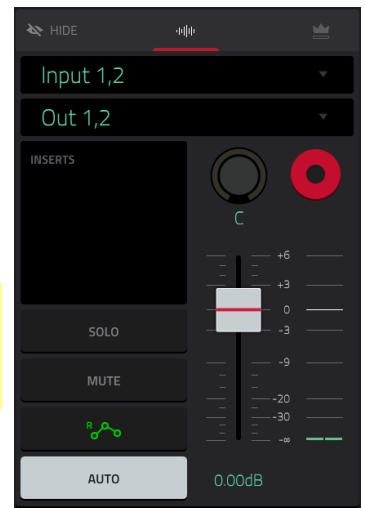

## Sequence Section

The **Sequence** section shows the current sequence and its information.

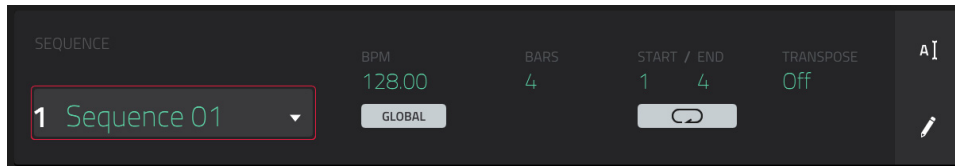

Use the **Sequence** field to select a sequence.

**To edit the name of the sequence**, tap the **cursor icon** on the right edge of the section, and use the virtual keyboard that appears.

Use the **BPM** field to adjust the tempo of the sequence.

**To set whether the sequence follows its own tempo (Sequence) or a global tempo (Global)**, tap the **Sequence/Global** button under the **BPM** field. Alternatively, press and hold **Shift+Tap**.

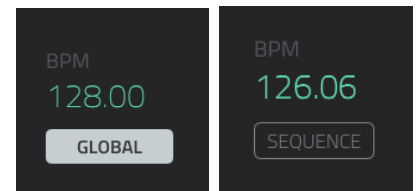

Use the **Bars** field to adjust the length of the sequence in bars.

The **Loop** button shows whether the sequence (or a part of it) will loop or not.

**To enable or disable looping**, tap the button.

**To set the start point and end point of loop**, tap the **Start** or **End** field (respectively) and then use the **data dial** or the **-/+** buttons, or double-tap the field and use the numeric keyboard that appears.

**Note:** The **Last Bar** value of the **Delete Bars** and **Copy Bars** processes depends on the total length of the sequence.

Use the **Transpose** field to set the transposition (in semitones) of the entire sequence.

To edit the sequence, tap the **pencil icon** on the right edge of the section. The **Sequence Edit/Copy** window will open.

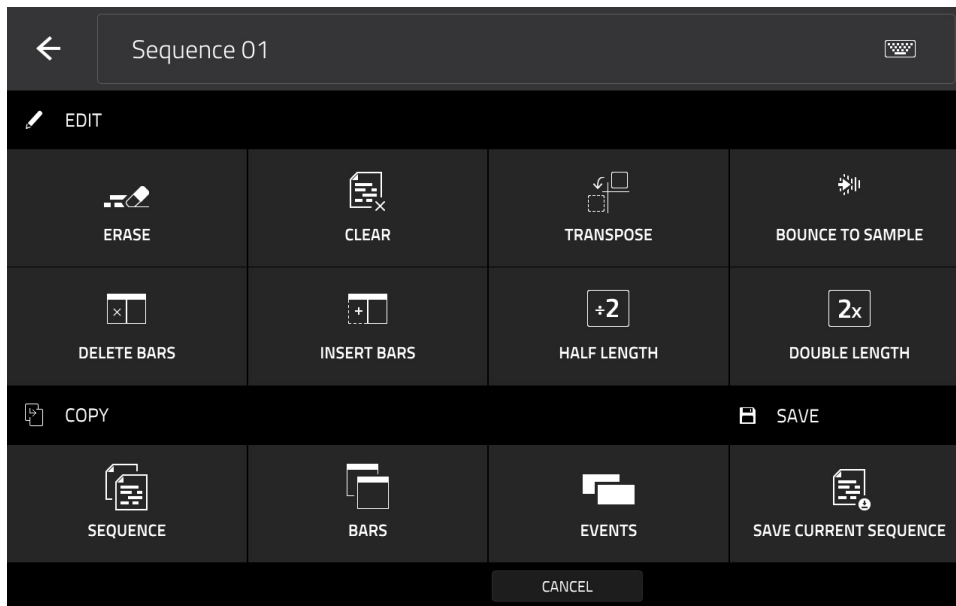

You can use any of these functions as described below, though there are fewer options for audio tracks than for MIDI tracks.

To return to Main Mode, tap **Cancel** or the left arrow (←) in the upper-left corner of the screen. Alternatively, press **Main**.

To edit the name of the sequence, tap the top of the screen and use the virtual keyboard that appears.

The **Erase** function erases all or part of a track in a specific sequence.

**To select the sequence you want to erase**, use the **Sequence** field.

**To select the track you want to erase within the sequence**, use the **Track** field.

**To set the time range of the sequence you want to erase**, use the **Bar**, **Beat**, and **Tick** fields. The left fields set the start of the time range, and the right fields set the end of the time range.

**To select what types of events you erase**, select one of the **Erase** options:

**All** erases all pad events from the designated time range and reset all of its settings.

**Automation** erases only automation from the designated time range.

**Note** erases only specific pad events from the designated time range. In the diagram of the eight pad banks that appears, press each pad in each bank to select or deselect its notes. This option is available only for MIDI tracks, not audio tracks.

**Except Note** erases everything **except** pad events from the designated time range. This option is available only for MIDI tracks, not audio tracks.

**To confirm your choice**, tap **Do It**.

**To return to the previous screen**, tap **← Back** or anywhere outside the window.

**To cancel and return to Main Mode**, tap **Cancel**.

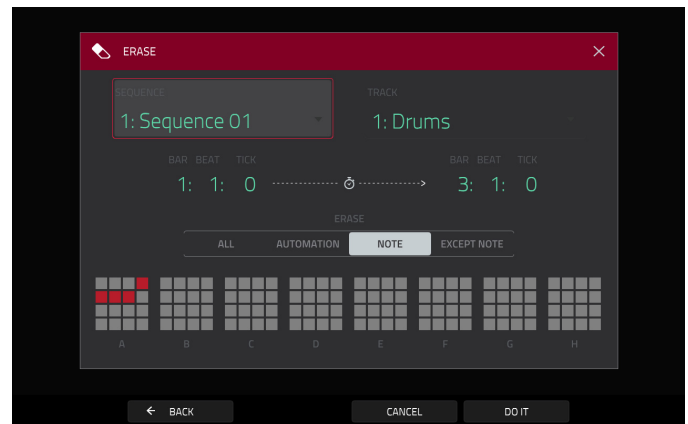
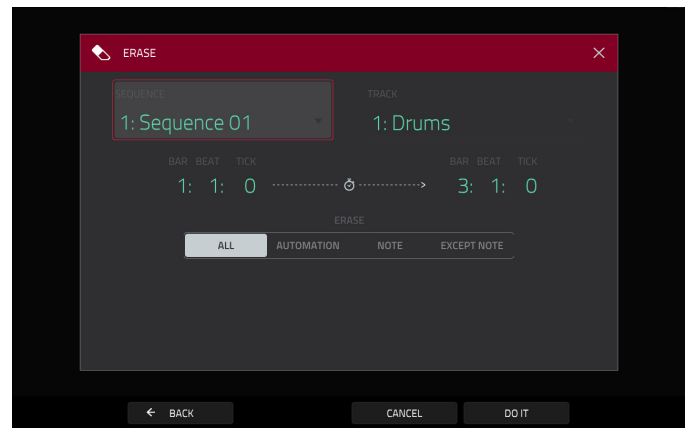

The **Clear** function erases **all** events from the sequence and resets **all** of its settings.

**To confirm your choice**, tap **Clear**.

**To return to the previous screen**, tap **Cancel**.

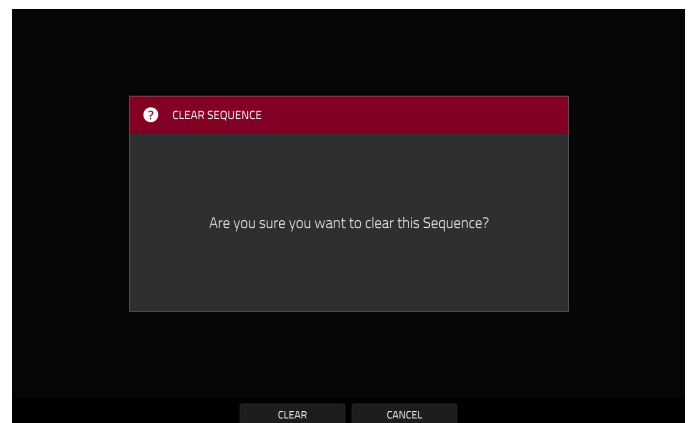

The **Transpose** function transposes a range of events on a track in a sequence. The events within that range will shift accordingly in the Grid View. This option is available for MIDI tracks only.

**To select the sequence you want to transpose**, use the **Sequence** field.

**To select the track you want to transpose within the sequence**, use the **Track** field.

**To set the time range of the sequence you want to transpose**, use the two sets of **Bar**, **Beat**, and **Tick** fields. The left fields set the start of the time range, and the right fields set the end of the time range.

**For drum programs**, use the two **Pad** fields to select the “source” pad (whose events you want to move) and “destination” pad (where the events will be placed). Tap each field and then press the desired pad.

**For keygroup programs, plugin programs, and MIDI programs**, set the range and amount of transposition:

**Range:** Use the two **Note** fields to set the range of notes of the events you want to transpose. Note events within this range will be transposed, while note events outside of this range will remain unchanged.

**Transpose:** Use this field to set how many semitones up or down you want to transpose the note events.

**To confirm your choice**, tap **Do It**.

**To return to the previous screen**, tap **← Back** or anywhere outside the window.

**To cancel and return to Main Mode**, tap **Cancel**.

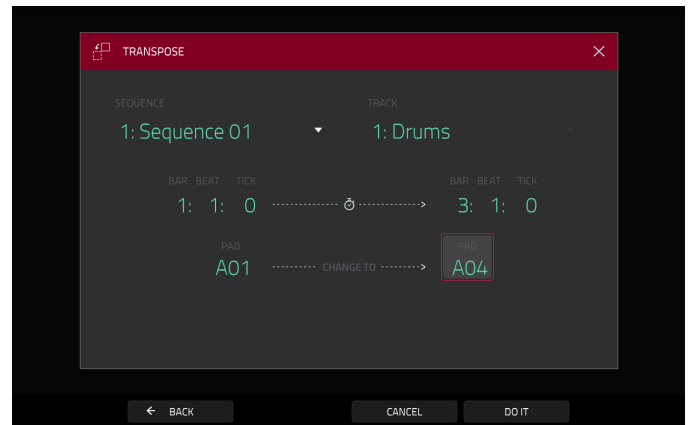

The **Bounce to Sample** function **immediately** renders the sequence (all of its tracks) as an audio sample and places it in the project’s sample pool. By default, it will be named **Bounce -** and appended with the sequence name.

If you have already used this function on this sequence, then you will be asked if you want to overwrite the existing sample with this new one or cancel.

**To continue and save the sequence over the existing one**, tap **Replace**.

**To cancel**, tap **Cancel**.

The **Delete Bars** function removes a range of bars from a sequence.

To select the sequence whose bars you want to delete, use the **Sequence** field.

To set the range of bars you want to delete, use the **First Bar** and **Last Bar** fields. The bar in each field and all bars in between them will be deleted.

To confirm your choice, tap **Do It**.

To return to the previous screen, tap **← Back** or anywhere outside the window.

To cancel and return to Main Mode, tap **Cancel**.

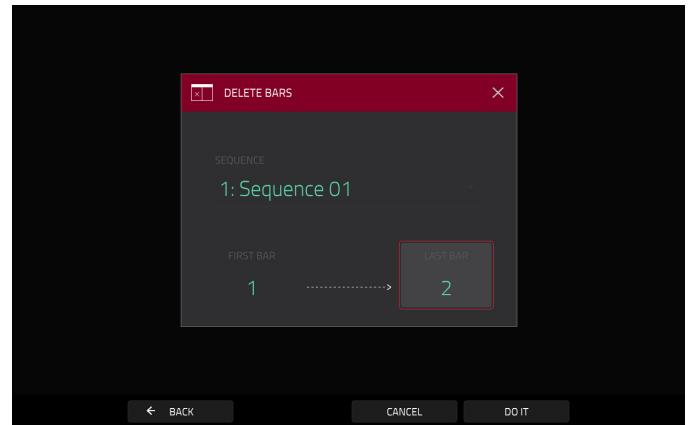

The **Insert Bars** function adds empty bars to a sequence at a specified point.

To select the desired sequence, use the **Sequence** field.

To set how many bars you will insert, use the **# of Bars** field.

To set the time signature of the inserted bars, use the two **Time Sig** fields.

To set where you will insert the bars, use the **Before Bar** field. The bars will be inserted before this one.

To confirm your choice, tap **Do It**.

To return to the previous screen, tap **← Back** or anywhere outside the window.

To cancel and return to Main Mode, tap **Cancel**.

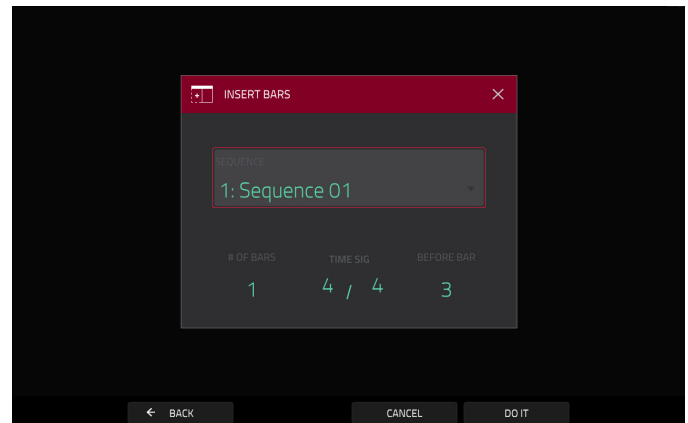

The **Half Length** function will **immediately** halve the length of the sequence (without deleting any note events).

The **Double Length** function will **immediately** double the sequence and copy all events from the first half to the second half.



The **Copy Sequence** function copies the contents of one sequence to another.

**To select the “source” sequence**, use the **Copy Contents of Sequence** field. This is the sequence whose events you want to copy.

**To select the “destination” sequence**, use the **Over Contents of Sequence** field. This is the sequence where the source sequence will be copied.

**To confirm your choice**, tap **Do It**.

**To return to the previous screen**, tap **← Back** or anywhere outside the window.

**To cancel and return to Main Mode**, tap **Cancel**.

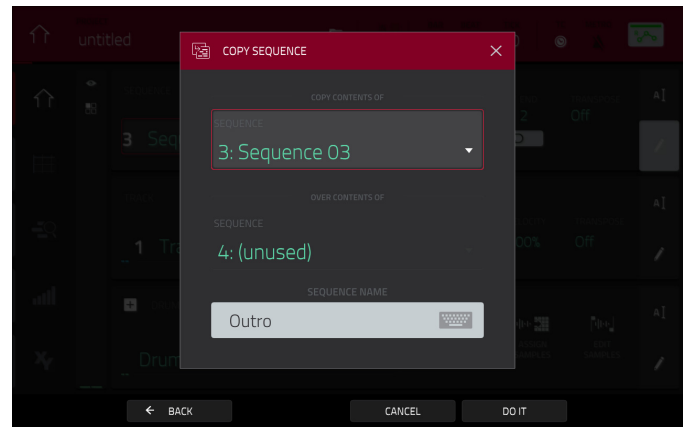

The **Copy Bars** function copies a range of bars from a sequence and adds them to another at a specified point.

**To select the “source” sequence**, use the **From Sequence** field. This is the sequence whose bars you want to copy.

**To set the range of bars to copy in the source sequence**, use the **First Bar** and **Last Bar** fields.

**To select the “destination” sequence**, use the **To Sequence** field. This is the sequence where the source sequence bars will be copied.

**To set where you want to add the copied bars**, use the **After Bar** field. The copied bars will be inserted after this one.

**To set how many instances of the copied bars you want to add**, use the **Copies** field.

**To overwrite the destination sequence**, tap **Replace**.

**To add the events to the destination sequence without erasing anything**, tap **Merge**.

**To return to the previous screen**, tap **← Back** or anywhere outside the window.

**To cancel and return to Main Mode**, tap **Cancel**.

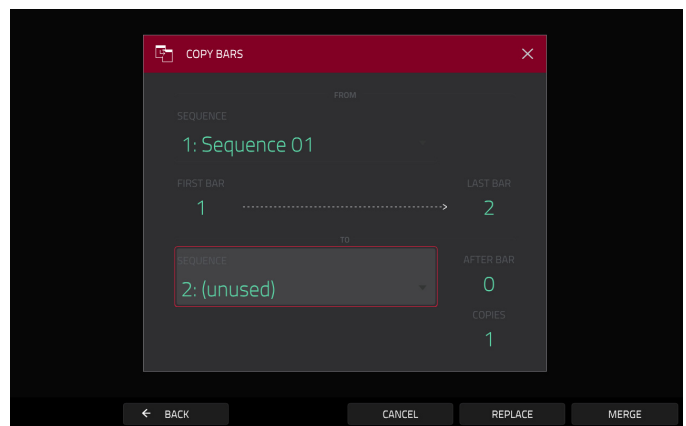

The **Copy Events** function copies a range of events or selected audio track regions from a sequence and adds them to another at a specified point.

To select the “source” sequence, use the **From Sequence** field. This is the sequence whose content you want to copy.

To select the “source” track, use the **From Track** field. This is the track whose content you want to copy.

To specify the pads or notes to copy events from, use the **Pads** or **Notes** field. By default, this will be set to **All** to copy all events in the current track.

To set the time range of the events or the audio track you want to copy, use the **Bar**, **Beat**, and **Tick** fields. The left fields set the start of the time range, and the right fields set the end of the time range.

To set what content is copied, use the field below the dotted arrow. **Copy All Events** will copy and paste all events in the track. **Copy Only Selected Events** will copy and paste only the events that are currently selected.

To select the “destination” sequence, use the **To Sequence** field. This is the sequence where the content of the source sequence will be copied.

To select the “destination” track, use the **To Track** field. This is the track where the content of the source track will be copied.

To set where you want to add the copied events or audio track, use the **Bar**, **Beat**, and **Tick** fields. The events or audio track will be added after this point.

To set how many instances of the copied events or audio track you want to add, use the **Copies** field.

To set whether you want to copy the events in the time range or the selected notes in the **Grid View** or **List Edit Mode**, use the **Selection** field. Set this to **All events** to copy the notes in the time range determined by the **Bar**, **Beat**, and **Tick** fields above, or set this to **Selected events** to copy only the events currently selected in the **Grid View** or **List Edit Mode**. This field is available for MIDI tracks only.

To overwrite the destination sequence, tap **Replace**.

To add the events to the destination sequence without erasing anything, tap **Merge**.

To return to the previous screen, tap **← Back** or anywhere outside the window.

To cancel and return to **Main Mode**, tap **Cancel**.

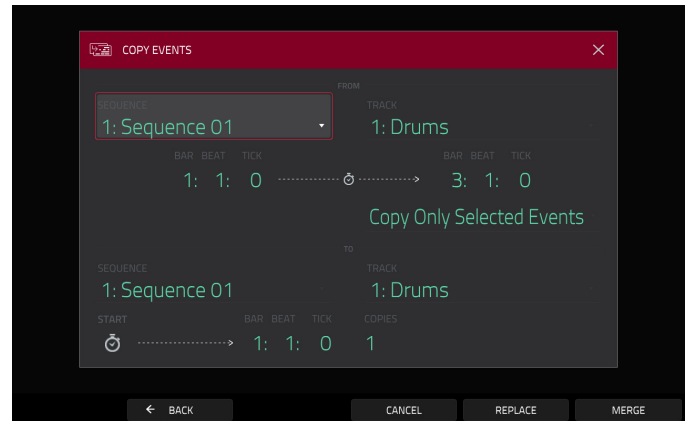
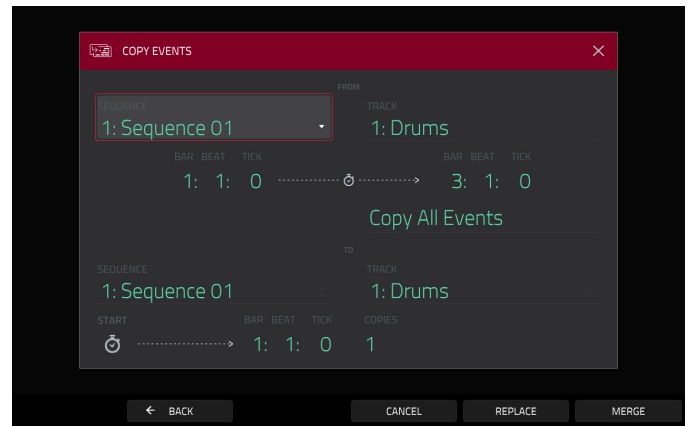

The **Save Current Sequence** function saves the current sequence to an external storage device or the internal drive of your MPC hardware.

**To select the storage device you want to view**, tap it in the **Storage** column on the left.

**Internal** is the internal drive of MPC X/Live/Live II/One/Key 61/Key 37.

**MPC Documents** is a shortcut to the **MPC Documents** folder on the internal drive of MPC X/Live/Live II/One/Key 61/Key 37.

If you have storage devices connected to USB ports or SD card slot of MPC X, MPC Live, MPC Live II, MPC One, MPC Key 61, MPC Key 37, or your computer (with MPC Studio or MPC Touch), they will appear in this column, as well.

**To enter a folder**, double-tap it. Alternatively, turn the **data dial** or use the **-/+** buttons to move through the list, and press the **data dial**, or the **center cursor** or **Enter** (MPC X), to enter a folder. You can also tap one of the five **folder buttons** in the upper-right to jump immediately to those pre-assigned file paths (see [Browser](#) to learn how to do this).

**To create a new folder**, tap **New Folder**, use the virtual keyboard that appears to enter a name, and then tap **Do It**. You will immediately enter the new folder.

**To move up one folder level**, tap the **folder/↑ icon** in the upper-left corner.

**To name the file**, tap the **File Name** field at the bottom of the screen, and use the virtual keyboard that appears.

**To save the file**, tap **Save**.

**To cancel and return to the Menu**, tap **Cancel**. Alternatively, tap the **← icon** in the upper-left corner.

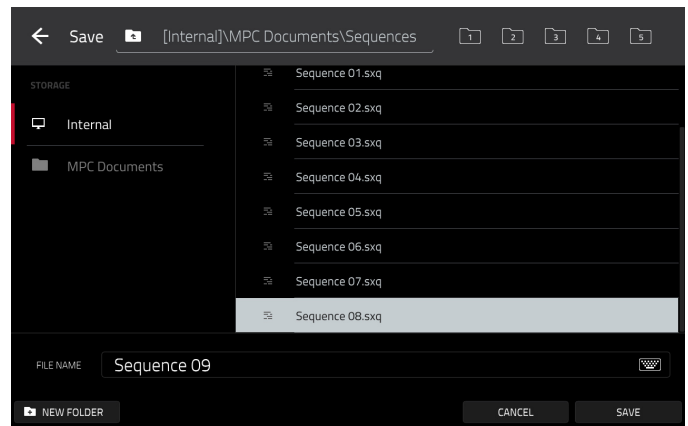

## Track Section

The **Track** section shows the current track, program type, and its information.

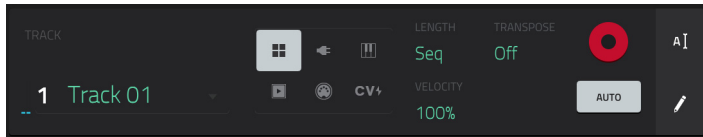

The **Track** section while using a MIDI track.

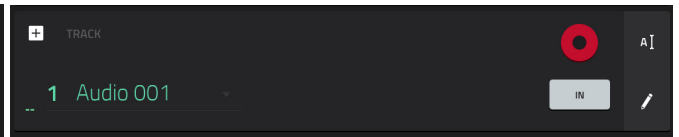

The **Track** section while using an audio track.

The **Track** field shows the track number and its name.

**To edit the name of the track**, tap the **cursor icon** on the right edge of the section and use the virtual keyboard that appears.

### While using a MIDI track:

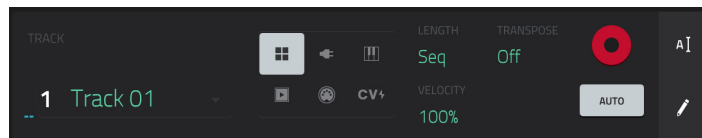

The **program selector** indicates the type of program through which the track is being routed. The specific program name is displayed below in the **Program** section. You can use the program selector to change program type (and then select a specific program of that type in the **Program** section below it).

**To select a drum program**, tap the **four-squares icon**.

**To select a keygroup program**, tap the **piano-keys icon**.

**To select a clip program**, tap the **play-button icon**.

**To select a MIDI program**, tap the **bars icon**.

**To select a CV program**, tap the **CV icon**.

**To select a plugin program**, tap the **plug icon**.

Use the **Length** field to set how long the track is in beats. If you select the minimum value, **Seq** or **0** (if you use the numeric keypad), the track will be the exact same length as its sequence.

**Tip:** This feature lets you maintain tracks of different lengths. For instance, you could play a 1-bar drum sequence repeatedly under a 4-bar bass line.

Use the **Velocity** field to set how loudly or quietly a track plays relative to its recorded levels. When set to **50%**, the track will be played with half the velocity it was originally played. When set to **200%**, the track will play twice as loud. The maximum velocity level is still **127**, though.

Use the **Transpose** field to set the transposition (in semitones) of the entire track.

Use the **MIDI Ch** field to select the MIDI channel the plugin or MIDI program uses. Use this setting when you are working with a virtual instrument plugin that supports multi-mode.

Tap the **Record Arm** button to record-enable the track. When you begin MIDI recording, the MIDI events will be recorded to this track.

**Tip:** You can select multiple tracks in the Track View by pressing and holding **Shift** while tapping the **Arm** button to each track, or by changing the Rec Arm Behavior setting in the [Preferences](#).

Use the **Monitor** button to set how your MIDI track will be monitored. Tapping it will cycle through its four states:

When set to **Off**, the track's MIDI input is not monitored, and playback of recorded events will be heard. This setting is useful when using keyboards with Local Control active.

When set to **In**, the track's MIDI input is always monitored regardless of the track's Record Arm state, and playback from recorded events will not be heard.

When set to **Auto**, the track's MIDI input is monitored when the track is record armed, and playback of recorded events will be heard.

When set to **Merge**, the track's MIDI input is always monitored, and playback of recorded events will be heard.

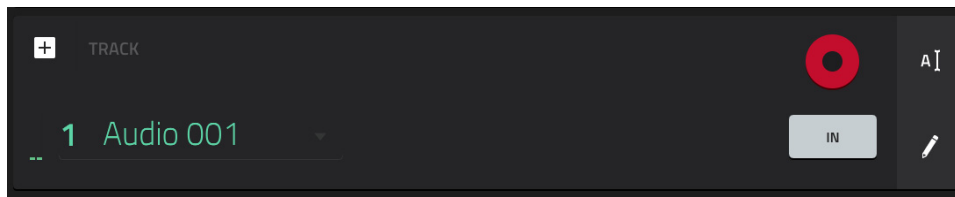
**While using an audio track:**

Tap the **Record Arm** button to record-enable the track. When you begin audio recording, the audio signal will be recorded to this track.

**Tip:** You can select multiple tracks in the Track View by pressing and holding **Shift** while tapping the **Arm** button to each track.

Use the **Monitor** button to set how your audio track will be monitored. Tapping it will cycle through its three states:

When set to **Auto**, you will hear incoming audio while the track is record-enabled only.

When **on**, you will hear incoming audio whether or not the track is record-enabled.

When **off**, you will never hear any incoming audio.

**To edit the track**, tap the **pencil icon** on the right edge of the section. The Track Edit window will open.

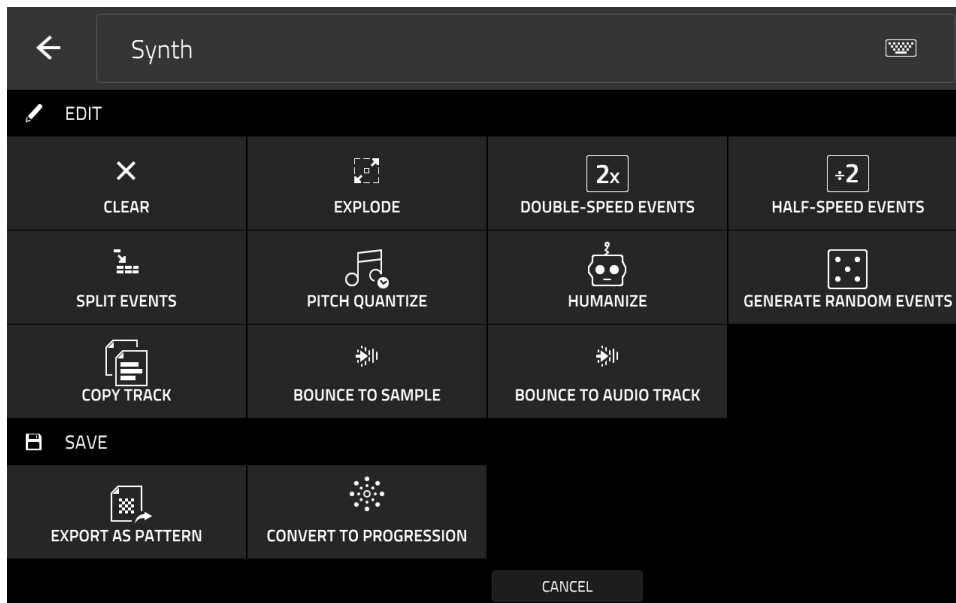

While using MIDI tracks, you can use any of these functions as described below.

**To return to Main Mode**, tap **Cancel** or the left arrow (←) in the upper-left corner of the screen. Alternatively, press **Main**.

**To edit the name of the track**, tap the top of the screen and use the virtual keyboard that appears.

The **Clear** function erases **all** events from the track and resets **all** of its settings.

**To confirm your choice**, tap **Clear**.

**To return to the previous screen**, tap **Cancel**.

The **Explode** function **immediately** splits the current track into multiple tracks—one for each distinct pad or note (pitch, not event). The current track also remains present and intact, while each track created from it is labeled with the track name and pad name or number.

The **Double-Speed Events** function **immediately** halves the lengths of all note events on the track as well as the distance between them. In other words, the track's notes are pressed closer together so the track sounds like it is playing at twice the previous speed. This does not actually affect the pitches of notes or the tempo.

The **Half-Speed Events** function **immediately** doubles the lengths of all note events on the track as well as the distance between them. In other words, the track's notes are spread further apart so the track sounds like it is playing at half of the previous speed. This does not actually affect the pitches of notes or the tempo.

The **Copy Track** function copies the contents of one track to another.

**To select the “source” track**, tap the **Copy Contents of Track** field. This is the track whose events you want to copy.

**To select the “destination” track**, tap the **Over Contents of Track** field. This is the track where the source track will be copied.

**To confirm your choice**, tap **Do It**.

**To cancel and return to Main Mode**, tap **Cancel**.

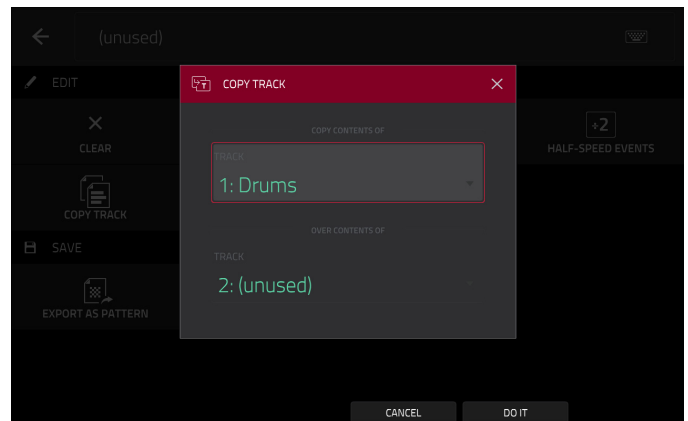

The **Split Events** function divides note events to create new rhythms and patterns.

**To select the how many events to create**, use the **Into** slider. Select **2** to **32** events.

**To apply the split to selected events**, tap the **Only selected events** field. Leave this unchecked to split all note events in the track.

**To confirm your choice**, tap **Do It**.

**To cancel and return to Main Mode**, tap **Cancel**.

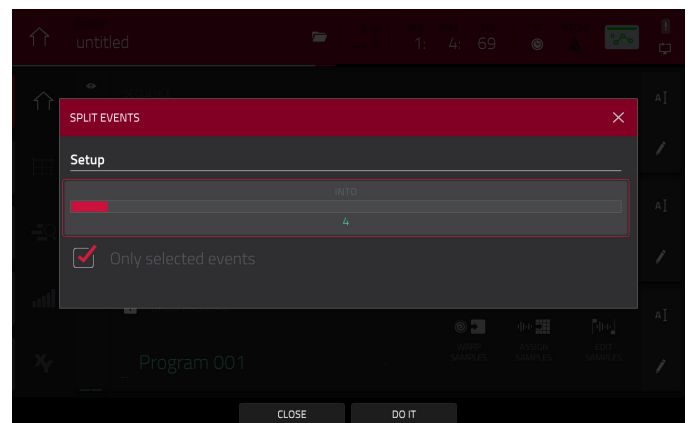

The **Pitch Quantize** function forces the pitches of note events into a specific scale.

To select the desired root note of the scale, use the **Root Note** field.

To select a type of scale, use the **Scale** field.

To determine which note events will be quantized, tap the **Only apply to selected events** checkbox.

When **on**, only the currently selected note events will be quantized.

When **off**, all pitches in the current track will be quantized.

To set lowest-possible and highest-possible pitches where the quantized note events will be placed, use the **Start Note** and **End Note** fields (respectively). If a note event is originally outside of this range, it will be forced to the nearest pitch (within the scale) inside the range.

To continue and quantize the note events, tap **Do It**.

To cancel, tap **Close**.

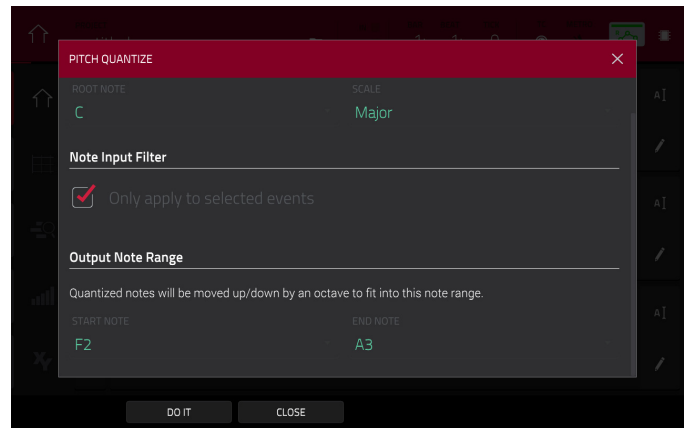

The **Humanize** function applies randomization to the timing, length, and/or velocity of MIDI note events.

To select whether or not humanization will be applied to the timing of MIDI events, tap the **Humanize Time** checkbox.

To select the maximum number of pulses by which the timing of an event will be adjusted, use the **Amount (Pulses)** slider.

To set how dramatically the humanization effect is applied to the timing, use the **Eagerness** slider. Negative values correspond to playing “ahead of the beat” while positive values correspond to playing “behind the beat.”

To set whether or not humanization will be applied to the duration of MIDI note events, tap the **Humanize Note Length** checkbox.

To set how dramatically the humanization effect is applied to note lengths, use the **Length (%)** slider.

To set whether or not humanization will be applied to the velocities of MIDI note events, tap the **Humanize Velocity** checkbox.

To set how dramatically the humanization effect is applied to note velocities, use the **Strength (%)** slider.

To determine which notes will use these humanization values, tap the **Only Apply to Selected Events** checkbox.

When **on**, just the currently selected notes will be humanized.

When **off**, all notes in the track will be humanized.

To apply humanization and keep this window open, tap **Apply**.

To apply humanization and close the window, tap **Do It**.

To close the window without making any changes, tap **Close**.

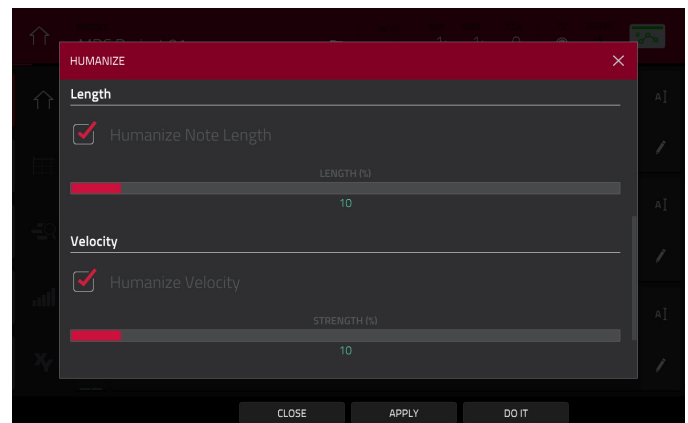
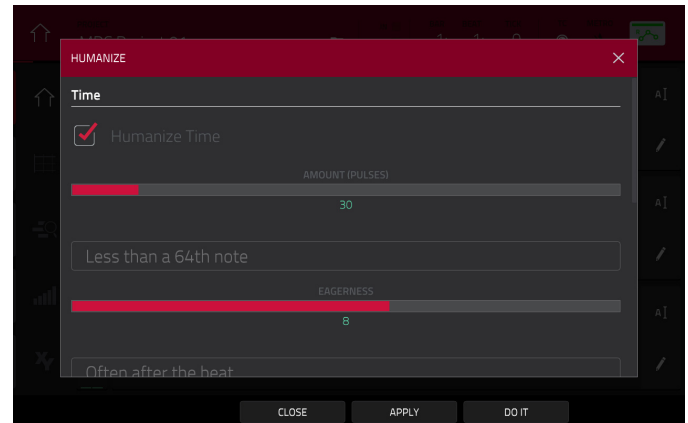

The **Generate Random Events** function creates random melodic or drum patterns on the current MIDI track.

To select the type of events you want to create, use the **Event Type** field to select **Drum Events** or **Melodic Events**.

To select how the events will be created relative to the existing events on the track, use the **Replace** field:

**Replace All Events:** Select this option to replace all events on the track with the randomly generated ones.

**Replace Events in Note Range:** Select this option to replace all events in the designated note range on the track with the randomly generated ones. Use the **Bank** or **Start Pad** and **End Pad** menus to set the note range for drum events or the **Start Note** and **End Note** menus to set the note range for melodic events.

**Add to Existing Events:** Select this option to add the randomly generated events to the track without replacing or overwriting the existing ones.

To set how many bars the events will use, use the **Pattern Size (Bars)** field. The highest possible value is the number of bars in the current sequence.

To select the duration of the events, use the **Note Length** field. (This feature is nonfunctional if **Legato** is enabled while generating melodic events.)

To generate the events and keep this window open, tap **Apply**.

To generate the events and close the window, tap **Do It**.

To close the window without generating any events, tap **Close**.

If **Event Type** is set to **Drum Events**:

To select the pad bank that will be used to generate the events, use the **Bank** field or select **Range** to use the **Start Pad** and **End Pad** menus to define a specific pad range instead.

To define a specific pad range over which the events will be generated, use the **Start Pad** or **End Pad** fields. You can use these fields only if the **Bank** menu is set to **Range**.

To set how closely together the events will be placed in the track, use the **Density (%)** slider.

To set how widely or narrowly the rhythmic patterns of the generated notes vary, use the **Rhythm Variation** slider.

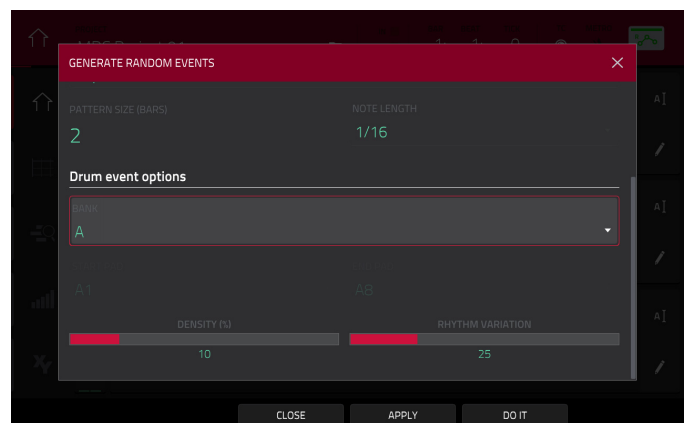
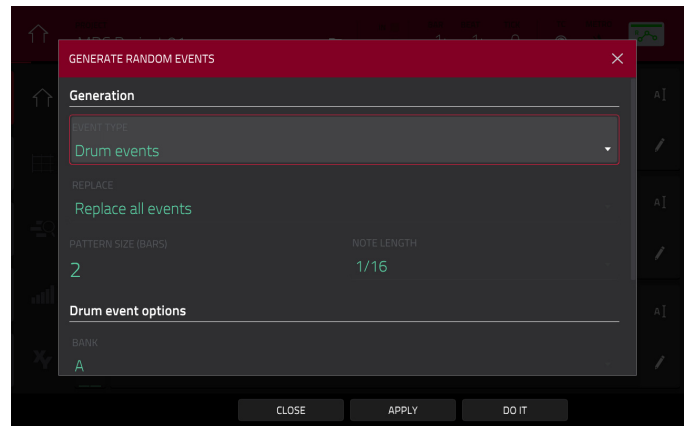



If **Event Type** is set to **Melodic Events**:

To define a specific note range over which the events will be generated, use the **Start Note** or **End Note** fields.

To enable or disable legato, tap the **Legato** checkbox.

When **on**, the generated notes will be extended or shortened to create a long, unbroken phrase from the first note event's start point to the last note event's end point. Each note event will sustain until another note event starts. If multiple note events start at the same time (and are not the last note events), their lengths will become identical.

When **off**, the generated notes will use the duration set by the **Note Length** menu.

To set the maximum number of note events that can be sounding simultaneously in the track, use the **Polyphony** field to select 1–8.

To determine whether or not the notes will use a scale, tap the **Constrain Notes to Scale** checkbox.

When **on**, the notes will be within the scale determined by the **Scale** menu.

When **off**, the notes will be chromatic.

To set how closely together the events will be placed in the track, use the **Density (%)** slider.

To set the root note of the scale that the notes will use, use the **Root Note** field.

To select the scale or mode that the generated notes will use, use the **Scale** field.

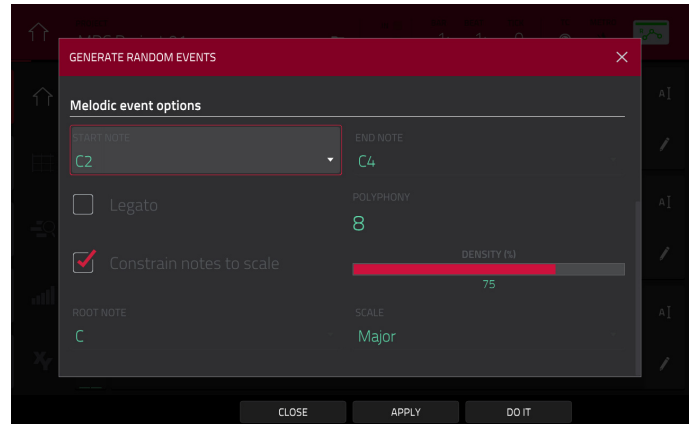
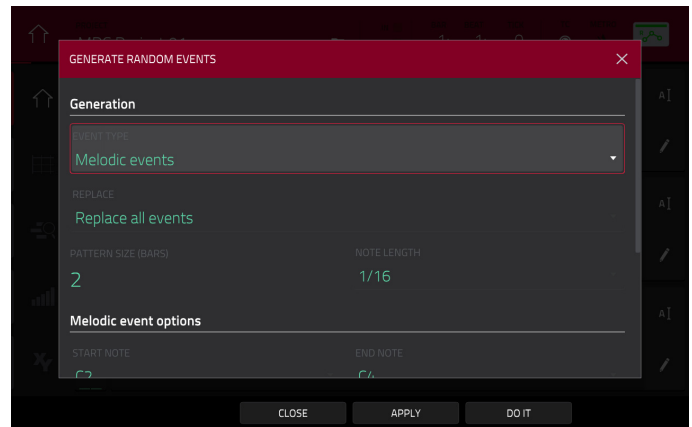

The **Bounce to Sample** function **immediately** renders the track (for the current sequence only) as an audio sample and places it in the project's sample pool. By default, it will be named **Bounce** - and appended with the track name. This function does not work for tracks that use MIDI programs or CV programs.

If you have already used this function on this track, then you will be asked if you want to overwrite the existing sample with this new one or cancel.

To continue and save the track over the existing one, tap **Replace**.

To cancel, tap **Cancel**.

The **Bounce to Audio Track** function **immediately** renders the track (for the current sequence only) as an audio track in the project. The Main Mode will automatically switch to the **Audio** tab. By default, it will be named **Audio** and appended with a number (e.g., **Audio 002**). This function does not work for tracks that use MIDI programs or CV programs.

If you have already used this function on this track, then you will be asked if you want to overwrite the existing sample with this new one or cancel.

**To continue and save the track over the existing one, tap Replace.**

**To cancel, tap Cancel.**

The **Export as Pattern** function saves the track (for the current sequence only) as a pattern (.mpcpattern) to an external storage device or the internal drive of MPC X/Live/Live II/One/Key 61/Key 37.

**To select the storage device you want to view, tap it in the Storage column on the left.**

**Internal** is the internal drive of MPC X/Live/Live II/One/Key 61/Key 37.

**MPC Documents** is a shortcut to the **MPC Documents** folder on the internal drive of MPC X/Live/Live II/One/Key 61/Key 37.

If you have storage devices connected to USB ports or SD card slot of MPC X, MPC Live, MPC Live II, MPC One, MPC Key 61, MPC Key 37, or your computer (with MPC Studio or MPC Touch), they will appear in this column, as well.

**To enter a folder, double-tap it.** Alternatively, turn the **data dial** or use the **-/+** buttons to move through the list, and press the **data dial**, or the **center cursor** or **Enter** (MPC X), to enter a folder. You can also tap one of the five **folder buttons** in the upper-right to jump immediately to those pre-assigned file paths (see [Browser](#) to learn how to do this).

**To create a new folder, tap New Folder, use the virtual keyboard that appears to enter a name, and then tap Do It.** You will immediately enter the new folder.

**To move up one folder level, tap the folder/⌂ icon in the upper-left corner.**

**To name the file, tap the File Name field at the bottom of the screen, and use the virtual keyboard that appears.**

**To save the file, tap Save.**

**To cancel and return to the Menu, tap Cancel.** Alternatively, tap the **← icon** in the upper-left corner.

The **Convert to Progression** function lets you convert the chords of the current track and sequence into a new progression. See [Addenda > Updates in MPC 2.8 > New Features > Custom Progressions](#) for more information.

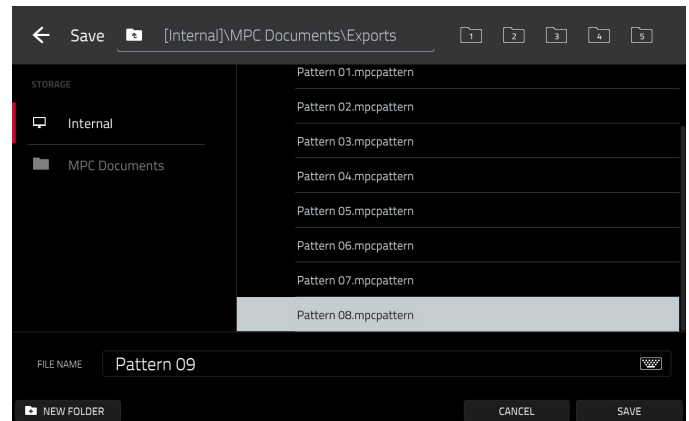

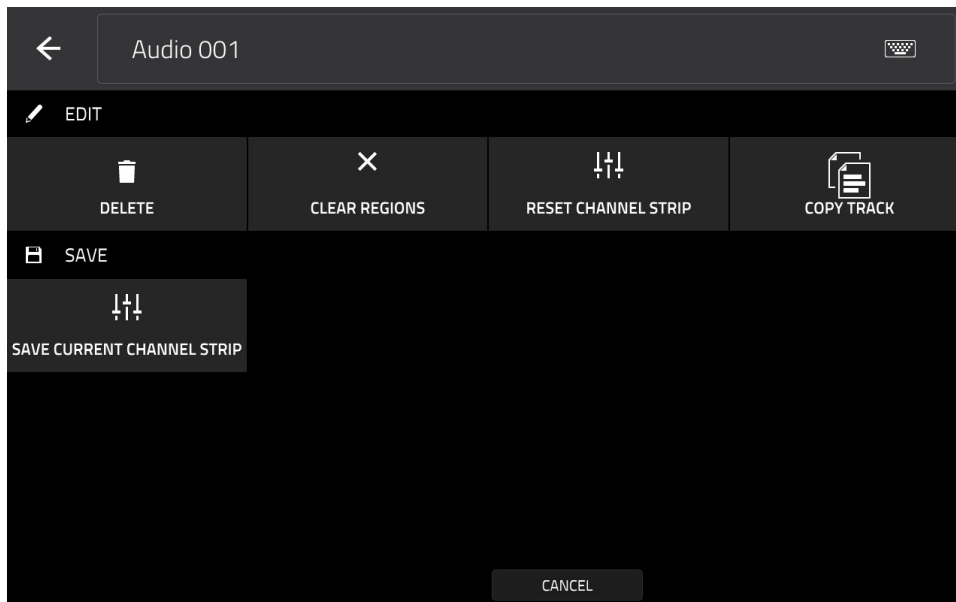

While using audio tracks, you can use any of these functions as described below.

**To return to Main Mode**, tap **Cancel** or the left arrow (←) in the upper-left corner of the screen. Alternatively, press **Main**.

**To edit the name of the track**, tap the top of the screen and use the virtual keyboard that appears.

The **Delete** function erases the entire audio track.

**To confirm your choice**, tap **Clear**.

**To return to the previous screen**, tap **Cancel**.

The **Clear Regions** function erases all **regions** from the audio track without erasing the track itself.

The **Reset Channel Strip** function:

- clears all **Insert** effect slots;
- turns **Mute**, **Solo**, automation, and **Monitor** off;
- resets the **pan knob** to the center;
- resets the **level slider** to **0.00 dB**; and
- turns the **Record Arm** button off.

It does not change the track's inputs or outputs.

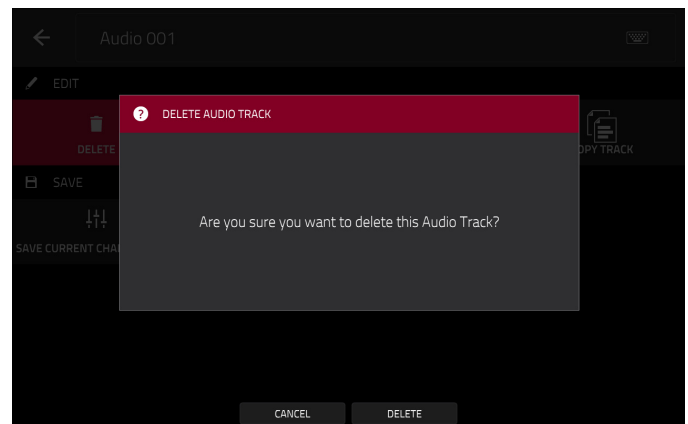

The **Copy Track** function copies the contents of one track to another.

**To select the “source” track**, tap the **Copy Contents of Track** field. This is the track whose events you want to copy.

**To select the “destination” track**, tap the **Over Contents of Track** field. This is the track where the source track will be copied.

**To rename the “destination” track**, use the **Track Name** field.

**To confirm your choice**, tap **Do It**.

**To cancel and return to Main Mode**, tap **Cancel** or anywhere outside the window.

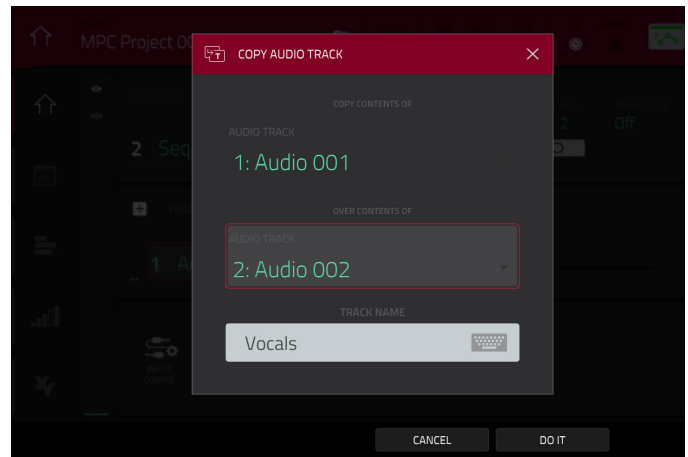

The **Save Current Channel Strip** function saves the current settings of the track channel strip (for the current audio track) to an external storage device or the internal drive of your MPC.

**To select the storage device you want to view**, tap it in the **Storage** column on the left.

**Internal** is the internal drive of MPC X/Live/Live II/One/Key 61/Key 37.

**MPC Documents** is a shortcut to the **MPC Documents** folder on the internal drive of MPC X/Live/Live II/One/Key 61/Key 37.

If you have storage devices connected to USB ports or SD card slot of MPC X/Live/Live II/One/Key 61/Key 37, or your computer (with MPC Studio/Touch), they will appear in this column, as well.

**To enter a folder**, double-tap it. Alternatively, turn the **data dial** or use the **-/+** buttons to move through the list, and press the **data dial**, or the **center cursor** or **Enter** (MPC X), to enter a folder. You can also tap one of the five **folder buttons** in the upper-right to jump immediately to those pre-assigned file paths (see [Browser](#) to learn how to do this).

**To create a new folder**, tap **New Folder**, use the virtual keyboard that appears to enter a name, and then tap **Do It**. You will immediately enter the new folder.

**To move up one folder level**, tap the **folder/⌵ icon** in the upper-left corner.

**To name the file**, tap the **File Name** field at the bottom of the screen, and use the virtual keyboard that appears.

**To save the file**, tap **Save**.

**To cancel and return to the Menu**, tap **Cancel**. Alternatively, tap the **← icon** in the upper-left corner.

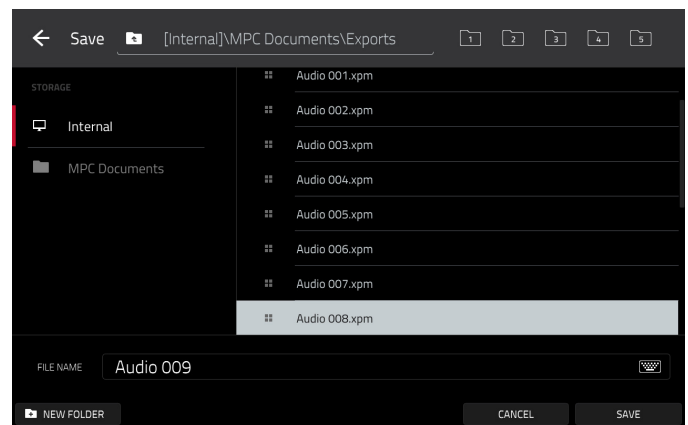

## Program Section

The **Program** section shows the current program. This section will appear differently depending on the type of program selected in the **Track** section above it.

For all program types **while using MIDI tracks**, you can do the following:

**To edit the name of the program**, tap the **cursor icon** on the right edge of the section. Use the virtual keyboard that appears to enter a new name, and then tap **Do It**.

**To create a new program of the currently selected type**, tap the **+ icon**. A new program of the same type will be created and appended with a number (e.g., **Program 002**).

For all program types **while using audio tracks**, you can do the following:

**To change the input source**, tap **Input Config**. This will show or hide the track channel strip. If you are viewing the audio track channel strip (not the main output channel strip), the first field will be automatically selected.

**To enter Audio Edit Mode**, tap **Edit Audio**. This is the same as tapping the **waveform-and-box icon** on the left edge of the screen.

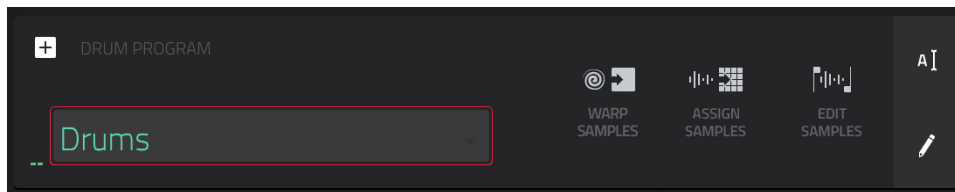

While viewing drum programs, the **Drum Program** field shows the name of the program.

Tap **Warp Samples** to enter the **first Sample** tab in Program Edit Mode immediately (see [Program Edit Mode > Drum Programs](#) to learn about this).

Tap **Assign Samples** to enter the **Sample Assign** tab in the Browser immediately (see [Browser](#) to learn about this).

Tap **Edit Samples** to enter Program Mode in Sample Edit Mode immediately (see [Sample Edit Mode > Program Mode](#) to learn about this). The sample shown will be the one in the top layer of the last pad you pressed.

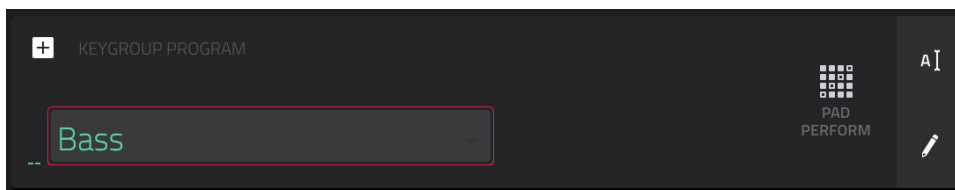

While viewing keygroup programs, the **Keygroup Program** field shows the name of the program.

Tap **Pad Perform** to open the Pad Perform window (see [Pad Perform Mode](#) to learn about this).

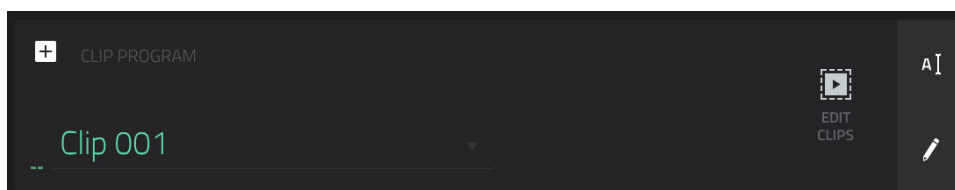

While viewing clip programs, the **Clip Program** field shows the name of the program.

Tap **Edit Clips** to enter Program Edit Mode, where you can assign samples (clips) to pads, edit each clip, and configure how each clip plays when launched (see [Program Edit Mode > Clip Programs](#) to learn about this).

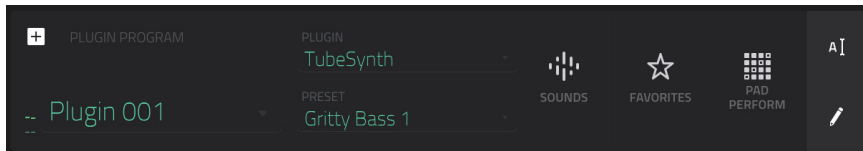

While viewing plugin programs, the **Plugin Program** field shows the name of the program.

Use the **Plugin** field to select the plugin the program is using. In the screen that appears, you can tap the **Type** or **Manufacturer** button at the bottom of the screen to enable or disable sorting of your plugins by type or maker.

**Note:** You have to specify the disk directory where your plugins are located. This can be done in the software's **Preferences**. See user guide in the MPC software to learn how to do this: click the **Help** menu, select **MPC Help**, and select **MPC User Manual**.

Use the **Preset** field to select a preset (if any) within the plugin the program is using.

Tap **Sounds** to open the Sounds menu, where you can browse plugins and presets. See [Addenda > Updates in MPC 2.11 > New Features > Sounds and Favorites](#) for more information.

Tap **Favorites** to open the **Favorites** menu, where you can quickly select from saved presets. See [Addenda > Updates in MPC 2.11 > New Features > Sounds and Favorites](#) for more information.

Tap **Pad Perform** to open the Pad Perform window (see [Pad Perform Mode](#) to learn about this).

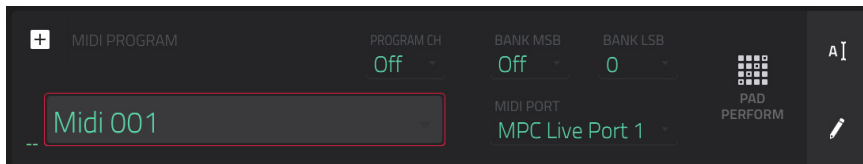

While viewing MIDI programs, the **MIDI Program** field shows the name of the program.

Use the **MIDI Port** field to select the port over which the program sends its MIDI data.

**Note:** You also have to configure the MIDI ports in the **Preferences**. See the user guide in the MPC software to learn how to do this: click the **Help** menu, select **MPC Help**, and select **MPC User Manual**.

Use the **Program Ch** field to select the program change message the program sends out.

Use the **MIDI Ch** field to select the MIDI channel over which the program sends its MIDI data.

Use the **Bank MSB** and **Bank LSB** fields to select the messages for Most Significant Byte and Least Significant Byte (respectively) that the program sends out.

Tap **Pad Perform** to open the Pad Perform window (see [Pad Perform Mode](#) to learn about this).

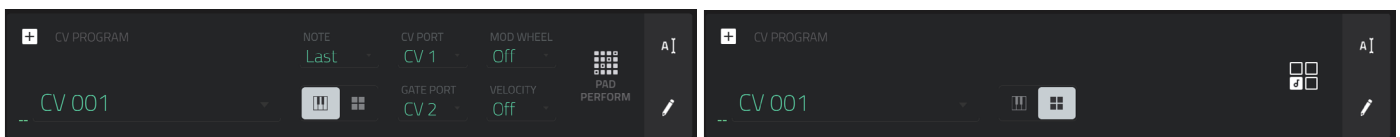

While viewing CV programs, the **CV Program** field shows the name of the program.

Tap the **keys icon** to set the program to **Melodic** operation.

Use the **Note** field to select the note tracking—the program's note track: **Lowest**, **Highest**, or **Last**.

Use the **CV Port** field to select the CV port the program is using.

Use the **Gate Port** field to select the Gate port the program is using.

Use the **Mod Wheel** field to select the CV port used by a modulation wheel on an external controller.

Use the **Velocity Port** field to select CV port the program will use to transmit velocity values.

Tap the **pads icon** to set the program to **Drum** operation.

Tap the **four squares with note icon** to assign each pad in the program to a specific **CV Port** and set its **Data Type**.

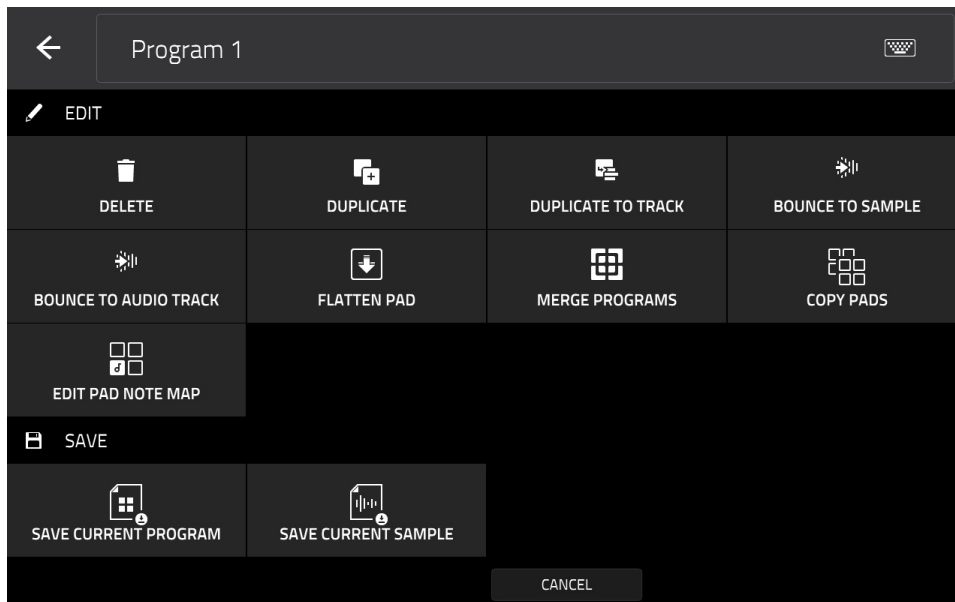

To edit the program, tap the **pencil icon** on the right edge of the section. The **Program Edit/Copy** window will open.

You can use any of these functions as described below.

**To return to Main Mode**, tap **Cancel** or the left arrow (←) in the upper-left corner of the screen. Alternatively, press **Main**.

**To edit the name of the program**, tap the top of the screen and use the virtual keyboard that appears.

The **Delete** function erases **all** events from the track and resets **all** of its settings.

**To confirm your choice**, tap **Clear**.

**To return to the previous screen**, tap **Cancel**.

The **Duplicate** function immediately creates an identical program. The duplicate program will use the same name but appended with a number (e.g., **Program 002**).

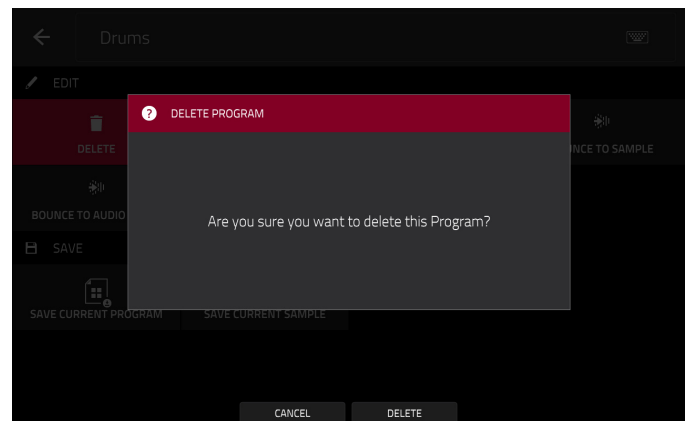

The **Duplicate to Track** function immediately creates an identical program on a new track. The duplicate program will use the same name but appended with a number (e.g., **Program 002**). The new track will be named **Track** and appended with a number (e.g., **Track 06**).

The **Bounce to Sample** function **immediately** renders all tracks that use that program (for the current sequence only) as an audio sample and places it in the project's sample pool. By default, it will be named **Bounce** - and appended with the program name. This function does not work for MIDI programs or CV programs.

If you have already used this function on this program, then you will be asked if you want to overwrite the existing sample with this new one or cancel.

**To continue and save the program over the existing one, tap Replace.**

**To cancel, tap Cancel.**

The **Bounce to Audio Track** function **immediately** renders that program (for the current sequence only) as an audio track in the project. The Main Mode will automatically switch to the **Audio** tab. By default, it will be named **Audio** and appended with a number (e.g., **Audio 002**). This function does not work for MIDI programs or CV programs.

If you have already used this function on this track, then you will be asked if you want to overwrite the existing sample with this new one or cancel.

**To continue and save the track over the existing one, tap Replace.**

**To cancel, tap Cancel.**

The **Flatten Pad** function renders all samples on a pad as an audio sample and places it on the first layer of that pad. The resulting sample is the audio signal produced by that pad at full velocity (**127**) after the pad channel strip, which means that it includes any assigned pad insert effects and the results of warping the sample. This function is useful if you need to reduce how CPU-intensive a pad or program is by essentially "embedding" the warping and effects in the sample itself. By default, it will use the name of the first sample. This function works for drum programs only. (This is the same as the **Flatten Pad** button shown at the top of the screen in Program Edit Mode.)

**To select the pad, press it or use the Pad menu.**

**To set the length of the audio tail, use the Audio Tail field.** This will add extra seconds to the end of the resulting audio file. This is useful if you are using effects or samples whose sounds exceed the defined audio length (e.g., long reverb or delay, one-shot samples with long decays, etc.). We recommend using an audio tail of at least a couple of seconds.

**To name the new sample, tap the Edit Name field, and use the virtual keyboard that appears.**

**To confirm your choice, tap Do It.**

**To cancel, tap Cancel.**

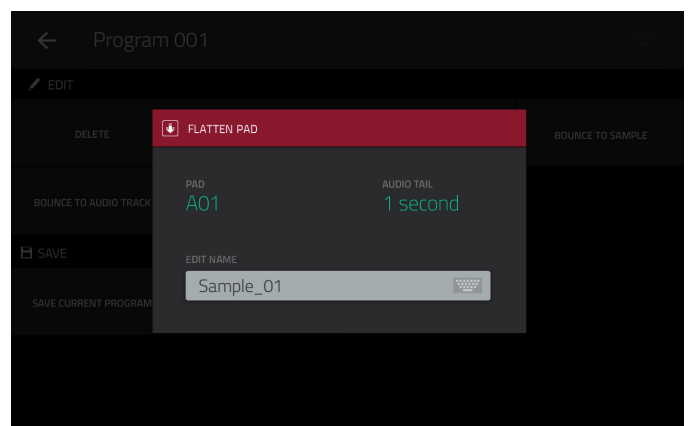



The **Copy Pads** function lets you copy one or more pads from one program to another.

To select the type of pad copy you would like to perform, use the **Copy Type** field. You can copy a single Pad, a Pad Bank or a Range of pads.

**Pad:** Use the **From Program** and **Pad** fields to select the program and pad you would like to copy from, and use the **To Program** and **Pad** fields to select the program and pad you would like to copy to.

**Bank:** Use the **From Program** and **From Bank** fields to select the program and pad bank you would like to copy from, and use the **To Program** and **To Bank** fields to select the program and pad bank you would like to copy to.

**Range:** Use the **From Program**, **Start Pad** and **End Pad** fields to select the program and range of pads you would like to copy from, and use the **To Program** and **Start Pad** fields to select the program and pad you would like to copy to.

To apply the settings, tap **Apply**.

To confirm the copy, tap **Do It**.

To cancel, tap **Close**.

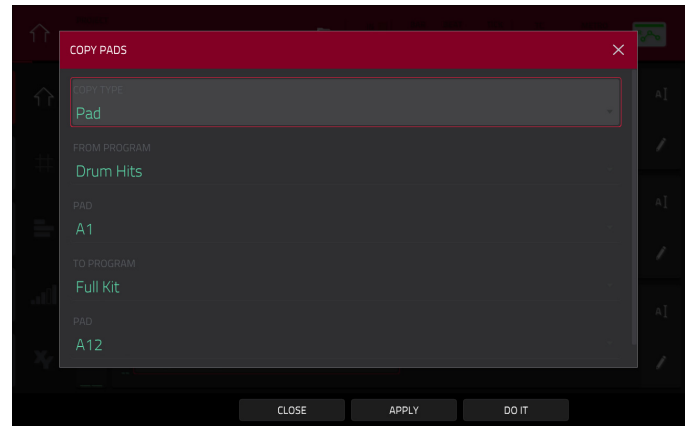

The **Edit Pad Map** function lets you assign specific MIDI notes to your pads in each program, except for keygroup programs.

To select a pad to edit, press it or use the **Pad** field.

To set the corresponding MIDI note for the pad, use the **MIDI Note** field.

Use the **Preset** buttons to quickly apply one of three common pad layout presets: **Chromatic C-2**, **Classic MPC** and **Chromatic C1**.

To close the window and return to the previous screen, tap the **X**, **Close** or anywhere outside the window.

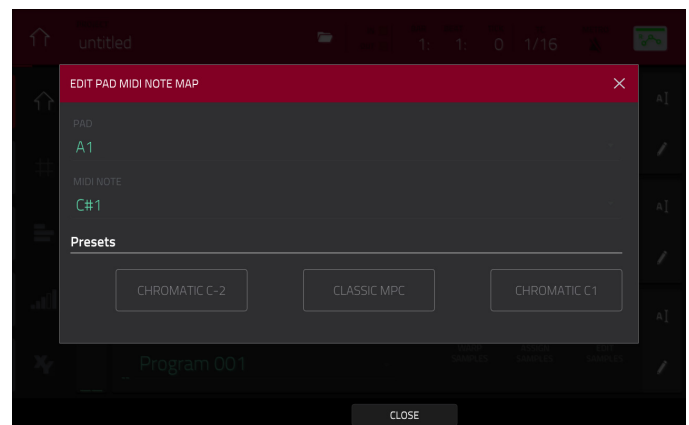

The **Save Current Program** or **Save Current Sample** function saves the current program or sample (the top layer of the last pad you pressed) (respectively) to an external storage device or the internal drive of MPC X/Live/Live II/One/Key 61/Key 37.

**To select the storage device you want to view**, tap it in the **Storage** column on the left.

**Internal** is the internal drive of MPC X/Live/Live II/One/Key 61/Key 37.

**MPC Documents** is a shortcut to the **MPC Documents** folder on the internal drive of MPC X/Live/Live II/One/Key 61/Key 37.

If you have storage devices connected to USB ports or SD card slot of MPC X/Live/Live II/One/Key 61/Key 37, or your computer (with MPC Studio/Touch), they will appear in this column, as well.

**To enter a folder**, double-tap it. Alternatively, turn the **data dial** or use the **-/+** buttons to move through the list, and press the **data dial**, or the **center cursor** or **Enter** (MPC X), to enter a folder. You can also tap one of the five **folder buttons** in the upper-right to jump immediately to those pre-assigned file paths (see [Browser](#) to learn how to do this).

**To create a new folder**, tap **New Folder**, use the virtual keyboard that appears to enter a name, and then tap **Do It**. You will immediately enter the new folder.

**To move up one folder level**, tap the **folder/↑ icon** in the upper-left corner.

**To name the file**, tap the **File Name** field at the bottom of the screen, and use the virtual keyboard that appears.

**To save the file**, tap **Save**.

**To cancel and return to the Menu**, tap **Cancel**. Alternatively, tap the **← icon** in the upper-left corner.

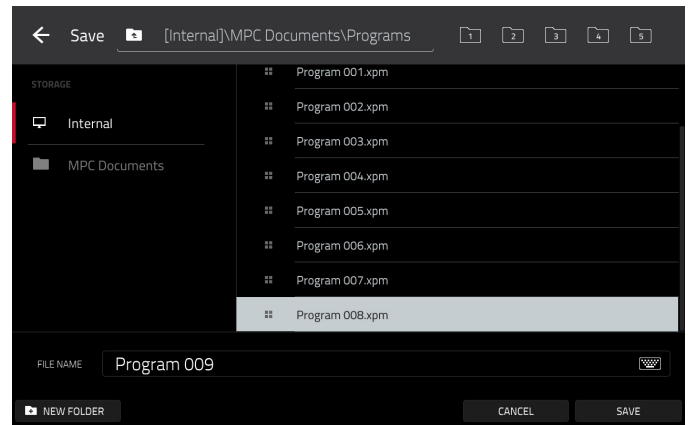

## Grid View

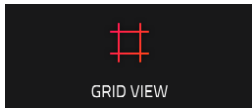

The Grid View lets you view and edit the note events of each track of a sequence in a project and their velocities. This mode has two different appearances: one for drum programs and one for keygroup programs, MIDI programs, and plugin programs.

For drum programs, the left column shows you all available pads in a vertical view with their corresponding data.

For keygroup programs, plugin programs, and MIDI programs, the left column shows a vertical “piano roll” keyboard.

To enter the Grid View, do either of the following:

- Press **Menu**, and then tap **Grid View**.
- Press **Shift+Main/Grid** (MPC Live II, MPC One)
- Press and hold **Mode** and press **Pad 2** (MPC Studio)

**Note:** The Grid View option is available when the currently selected track is a MIDI track. When an audio track is selected, it will show an icon for Audio Edit Mode instead of Grid View. To select a MIDI track (and enable Grid View), press **Main** to enter Main Mode, and then tap **MIDI** in the lower-left corner.

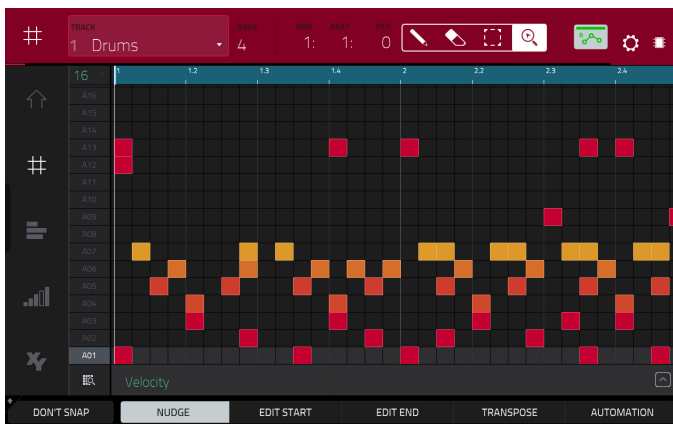

Grid View of a drum program.

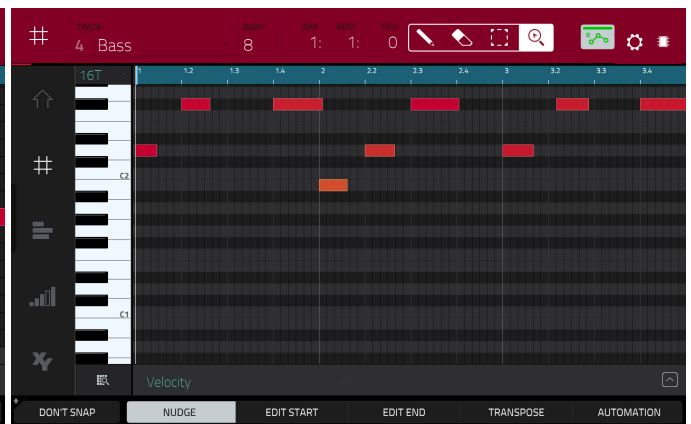

Grid View of a keygroup program or MIDI program.

The top of the screen shows the track name, sequence and timing information, and editing tools.

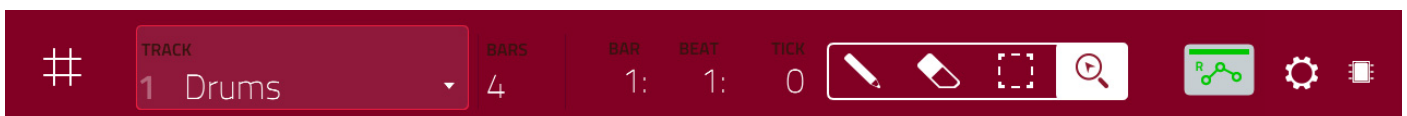

Use the **Track** field to select which track of the current sequence you want to show in the grid.

Use the **Bars** field to set the length of the sequence.

The time counter at the top of the screen indicates the current playhead position. This is shown in most of the modes. See [General Features > Time Counter/Locate](#) to learn about this.

In the Grid View, these four tool icons enable you to use different functions in the grid.



Tap one to select its mode:



**Pencil:** Draw Mode:

**To enter a note in an empty grid square**, tap the grid square.

**To select a note**, tap it.

**To move a note**, tap and drag it to another grid square.

**To erase a note**, double-tap it.



**Eraser:** Erase Mode:

**To erase a note**, tap it.



**Select Box:** Select Mode:

**Note:** Notes will remain selected if you switch to another mode. The selection will change, however, if you press a pad while **Hitting Pad Selects All Events** is set to **On**.

**To select a note**, tap it.

**To select multiple notes**, tap and drag across the grid to create a box around them.

**To move a note**, tap and drag it to another grid square.

**To move multiple notes**, select them as described above, and tap and drag them.

**To erase multiple notes**, select them as described above, and then select the **eraser tool** and tap any of the selected notes.



**Magnifying Glass:** Navigation Mode:

**To move to another part of the grid**, tap and drag it.

**To zoom in or out**, spread or pinch your fingers (respectively) on the grid. You can do this vertically, horizontally, or both at the same time.

The **Settings** window lets you configure certain Grid View settings.

To view the **Settings**, tap the **gear icon**.

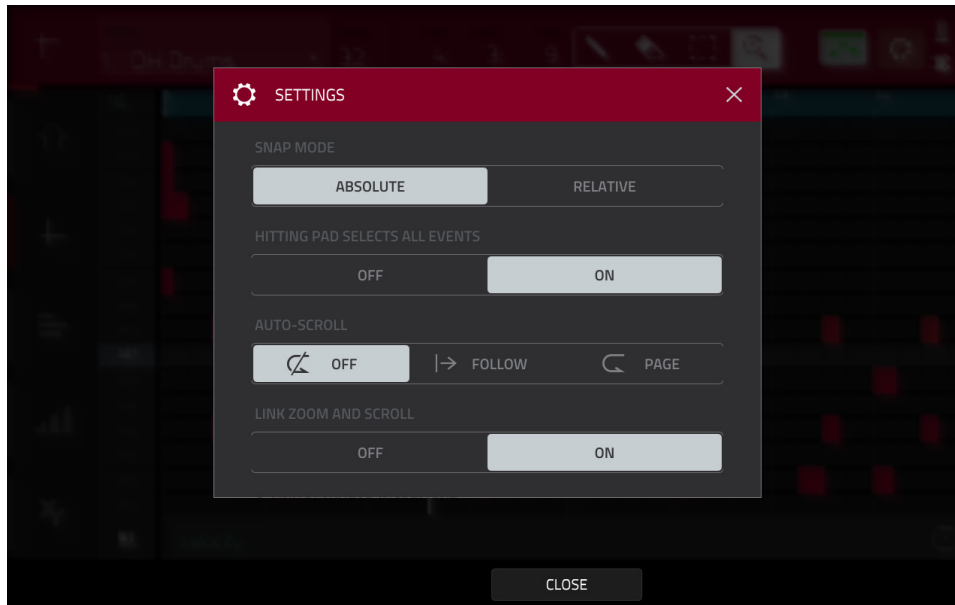

Use the **Snap Mode** selector to set how events “snap” to the grid.

**Absolute:** Events will “snap” to the nearest time division on the grid (as determined by the **TC** field or **Time Correct** window). This is the typical and traditional method of using the snap/quantization feature.

**Relative:** Events will “snap” to the nearest time division on the grid (as determined by the **TC** field or **Time Correct** window) **plus** the original time position of the event (e.g., an event that is originally three ticks past a time division on the grid will snap only to positions that are three ticks past every time division).

Use the **Hitting Pad Selects All Events** selector to turn the feature on or off. When on, pressing a pad will automatically select all note events for that pad in the sequence on that track. When off, pressing a pad will simply play its sound without selecting any note events.

Use the **Auto-Scroll** selector to set how the screen behaves relative to the audio playhead.

**Follow:** Depending on the zoom setting, the grid will scroll along in the background while keeping the audio playhead centered.

**Page:** The grid will move to the “next page” to follow the audio playhead.

**Off:** The grid will not move at all.

These functions also apply to Audio Edit Mode, List Edit Mode, and Sample Edit Mode.

Use the **Link Zoom and Scroll** selector to turn the feature on or off. When on, the zoom and scroll levels in the MPC software and your MPC hardware will always be the same. When off, the grid views can be adjusted separately using the MPC software and your MPC hardware.

**Note:** This setting is only available when connected to MPC software in controller mode.

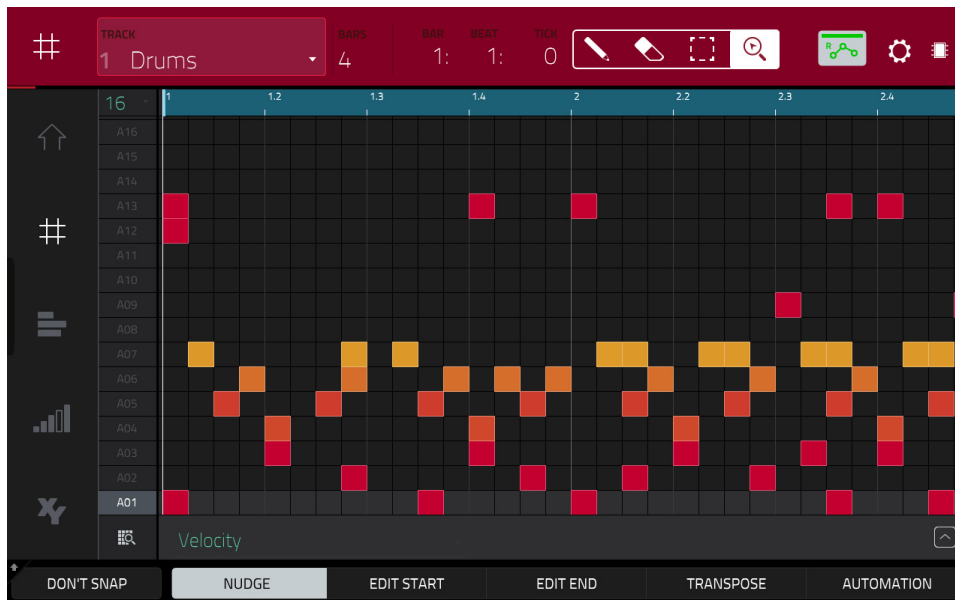

Regardless of which tool is selected, you can do any of the following to move, lengthen, shorten, or transpose any selected note/notes.

**To automatically set the grid to view one pad bank and two bars**, tap the **grid-and-magnifying-glass icon** in the lower-left corner.

**To undo your last action**, press **Undo**.

**To redo the last action you undid**, press and hold **Shift**, and then press **Undo/Redo**.

**To select all notes for a pad**, press the desired **pad**.

**To move the selected notes**, tap **Nudge** at the bottom of the screen, and then use the **data dial** or **-/+** buttons to shift the notes left or right. By default, you can position notes only by quantization values defined by the **Time Correct** value (see [General Features > Timing Correct \(TC\)](#) to learn about this).

**To move the selected notes without restricting** (“snapping”) **them to the quantization grid**, tap and hold **Don’t Snap** in the lower-left corner of the screen, and then use the **data dial** or **-/+** buttons to shift the notes. In this case, each nudge is equivalent to four ticks.

**To adjust the start point or end point of the selected notes** (without changing their position), tap **Edit Start** at the bottom of the screen, and then use the **data dial** or **-/+** buttons.

**To transpose the selected notes up or down**, tap **Transpose** at the bottom of the screen, and then use the **data dial** or **-/+** buttons.

**To copy the selected notes instantly**, press **Copy**. The selected notes will be duplicated and start immediately after the end of the last selected note. Nudge will be automatically selected so you can immediately use the **data dial** to move the copied notes,

**To switch to the previous or next track**, press and hold **Shift**, and then tap **Track -** or **Track +** (respectively) at the bottom of the screen.

**To mute or solo the track**, press and hold **Shift**, and then tap **Mute** or **Solo** (respectively) at the bottom of the screen.

To open the **Timing Correct** window, press and hold **Shift**, and then tap **TC** at the bottom of the screen. See [General Features > Timing Correct \(TC\)](#) to learn about this.

To select a time division directly, double-tap the **down arrow** (▼) in the upper-left corner of the grid and select a time division.

To adjust the metronome settings, press and hold **Shift**, and then tap **Click** at the bottom of the screen. See [General Features > Metronome \(Click/Metro\)](#) to learn about this.

The Grid View also contains a velocity/automation lane where you can easily adjust note velocities and automation parameters.

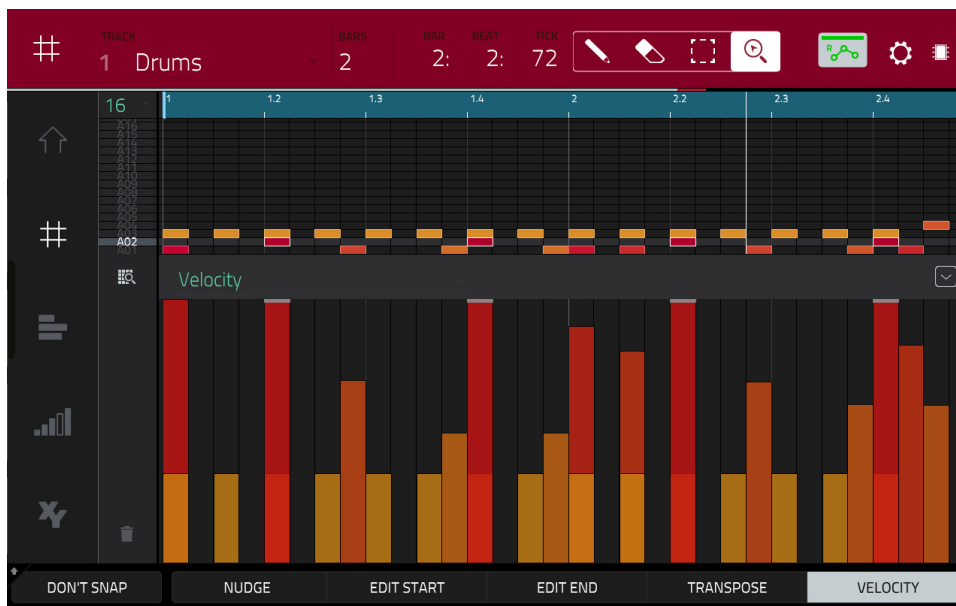

The velocity lane in the Grid View.

**To show or hide the velocity/automation lane:**

1. Tap the up **arrow** (∧) button in the lower-right corner to show the velocity/automation lane.
2. Tap the **down arrow** (∨) to hide the velocity/automation lane.

When viewing velocity in the lane, a vertical bar represents each note's velocity. The higher and more red the bar is, the higher the velocity is. Yellow bars indicate a lower velocity. Bars with a gray line at the top indicate a currently selected note.

To adjust the velocity of the selected notes, tap **Velocity** at the bottom of the screen, and then use the **data dial** or **-/+** buttons. The numeric value will appear on the screen.

See [Addenda > Updates in MPC 2.6 > New Features > Grid Automation Lanes](#) for more information on editing automation parameters.

Audio Edit Mode

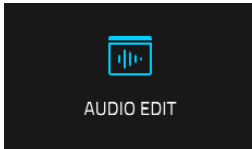

Audio Edit Mode lets you view and edit the audio tracks of a sequence in a project.

To enter Audio Edit Mode, press **Menu**, and then tap **Audio Edit Mode**.

**Note:** The Audio Edit option is available when the currently selected track is an audio track. When a MIDI track is selected, it will show an icon for Grid View instead of Audio Edit Mode. To select an audio track (and enable Audio Edit Mode), press **Main** to enter Main Mode, and then tap **Audio** in the lower-left corner.

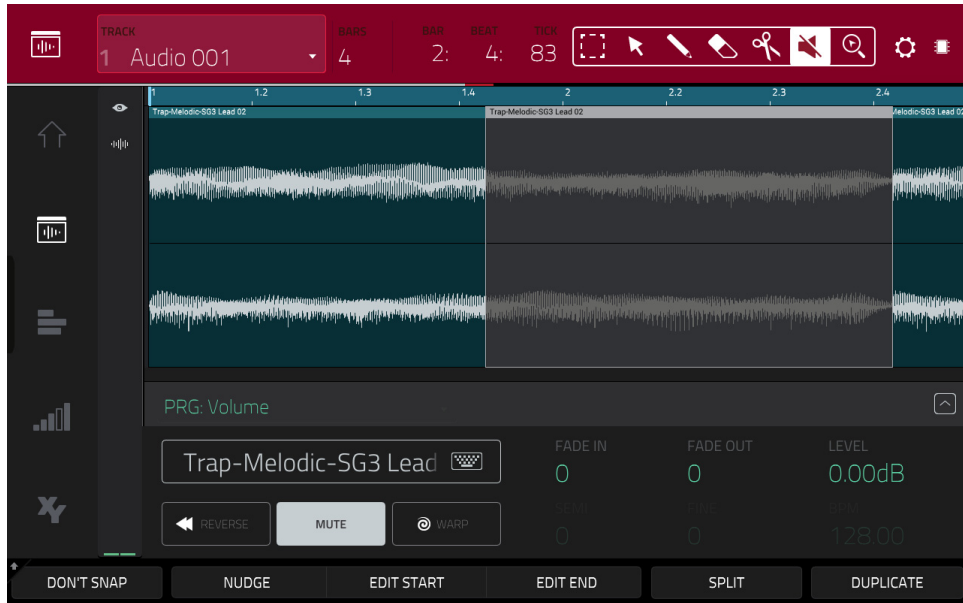

Audio Edit Mode with channel strip hidden.

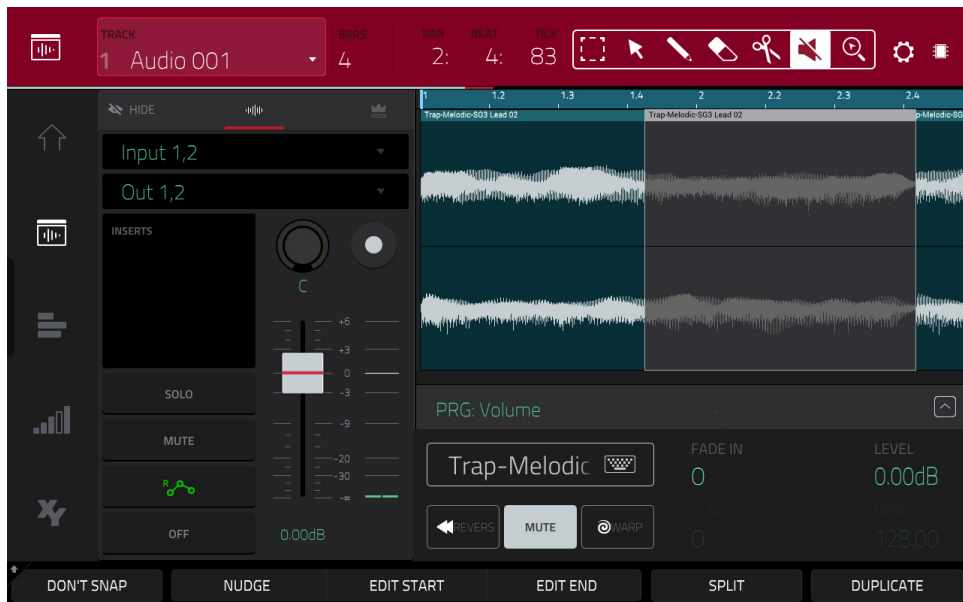

Audio Edit Mode with channel strip shown.



Below is a brief step-by-step process so you can get started recording audio tracks quickly. Continue reading the rest of this chapter to learn how to use Audio Edit Mode in different cases.

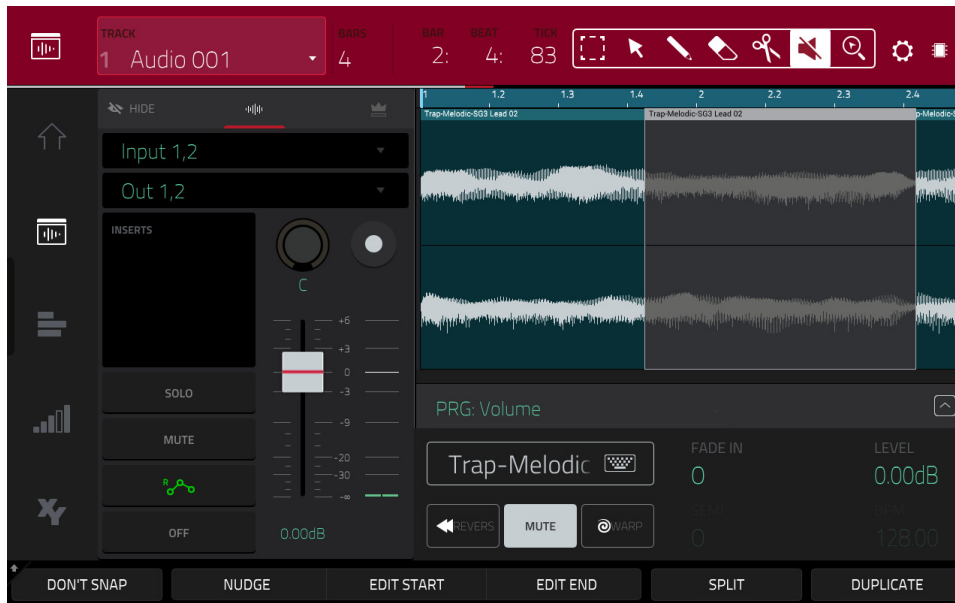

#### To record in Audio Edit Mode (or Main Mode):

1. If the channel strip is not already shown on the left side of the screen, tap the small **eye icon** to show it.
2. Connect a synthesizer or other line-level audio source to the appropriate input/inputs of your MPC hardware. Set the **Line/Phono selector** or **Inst/Line selector** (MPC Key 61) appropriately, too.
3. Double-tap the first field to select the input source of the external audio signal, which you can set to a pair of inputs (**Input 1,2–3,4** in Standalone Mode, **Input 1,2–31,32** in Controller Mode) or a single input (**Input 1–4** in Standalone Mode, **Input 1–32** in Controller Mode) (MPC One/Key 61/Key 37 do not use Inputs 3,4 but displays them to maintain compatibility with MPC X/Live/Live II/Touch, which do use them).
4. Double-tap the second field to select where the track is routed (**Out 1,2–7,8** and **Submix 1–8** in Standalone Mode, or **Out 1,2–31,32** in Controller Mode; MPC Live/Live II do not use Out 7,8, and MPC One/Key 61/Key 37 do not use Out 3,4–7,8 in Standalone Mode, but displays them to maintain compatibility with MPC X, which does use them).
5. Tap the **Monitor** button to set how your audio track will be monitored. Tapping it will cycle through its three states:
  - When set to **Auto**, you will hear incoming audio while the track is record-enabled only.
  - When **on**, you will hear incoming audio whether or not the track is record-enabled.
  - When **off**, you will never hear any incoming audio.
6. Turn the **3/4 Rec Gain** knob (MPC X), **Rec Vol** knob (MPC Live/Live II/One/Touch/Key 37), or **Gain** knob (MPC Key 61) to set the input level while sending an audio signal into your MPC hardware. You should now see the level in the meter. Make sure it does not exceed the maximum level (the meter should not be “peaking” constantly).
7. If **Mute** and **Solo** are on, tap or press them so they are **off**. We also recommend tapping the automation button so it is **off/gray** (not **green/Read [R]** or **red/Write [W]**). Alternatively, press and hold **Shift** and then press **Read/Write** (MPC X/Key 61) or **Automation** (MPC Key 37) so it is off.
8. Tap the **Rec Arm** button next to the **pan knob** or press **Rec Arm** (MPC X) to record-enable the track.
9. Press **Rec** to record-arm the sequence.
10. **To start recording**, press **Play** or **Play Start**—then play your audio source. You should hear your existing sequence playing in the background. You’ll see the waveform appear as a single “track region” as you record.
11. **To stop recording**, press **Stop**.

The top of the screen shows the track name, sequence and timing information, and editing tools.

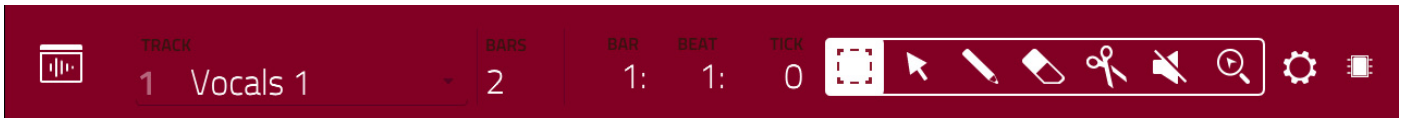

Use the **Track** field to select which track of the current sequence you want to show in the grid.

Use the **Bars** field to set the length of the sequence.

The time counter at the top of the screen indicates the current playhead position. This is shown in most of the modes. See [General Features > Time Counter/Locate](#) to learn about this.

In Audio Edit Mode, these seven tool icons enable you to use different functions in the track.



Tap one to select its mode:



**Marquee:** Marquee Mode:

**To select a track region**, tap the upper third of it.

**To move a track region** (or multiple selected track regions), tap and drag the upper third of it left or right.

**To split the track at two specific points** (creating a track region on either side and between them), tap and drag across the middle third of it to create a translucent white box, and then tap the upper third of that box.

**To shorten or lengthen a track region** (or multiple selected track regions), tap and drag the lower third of it left or right.



**Arrow:** Selection Mode:

**To select a track region**, tap it.

**To select multiple track regions**, tap and drag across the grid to create a box that highlights them. Double-tap the selected track regions to deselect them.

**To move a track region** (or multiple selected track regions), tap and drag the upper third of it left or right.

**To shorten or lengthen a track region** (or multiple selected track regions), tap its edge and drag it.

**Pencil: Draw Mode:**

**To enter a note in an empty grid square**, tap the grid square.

**To select a note**, tap it.

**To move a note**, tap and drag it to another grid square.

**To erase a note**, double-tap it.

**Eraser: Erase Mode:**

**To select multiple track regions**, tap and drag across the grid to create a box that highlights them.

**To erase a track region** (or multiple selected track regions), tap it.

**Scissors: Split Mode:**

**To split the track at a specific point** (creating a track region on either side), tap that point in the track.

**To select a track region**, tap its left-most edge.

**To select multiple track regions**, tap and drag across the grid to create a box that highlights them. Double-tap the selected track regions to deselect them.

**Mute: Mute Mode:**

**To select multiple track regions**, tap and drag across the grid to create a box that highlights them. Double-tap the selected track regions to deselect them.

**To mute or unmute a track region** (or multiple selected track regions), tap it.

**Magnifying Glass: Navigation Mode:**

**To move to another part of the track**, tap and drag it.

**To zoom in or out**, spread or pinch your fingers (respectively) on the grid. You can do this vertically, horizontally, or both at the same time.

The Settings window lets you configure certain Audio Edit Mode settings.

To view the Settings, tap the **gear icon**.

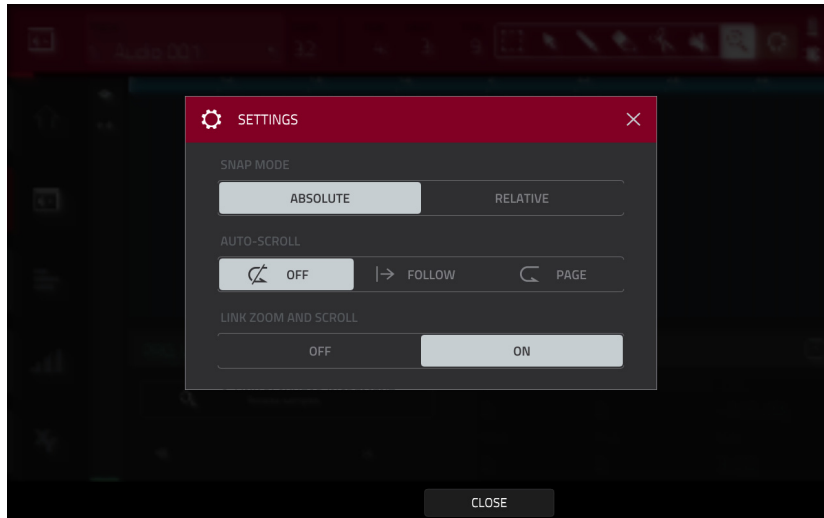

Use the **Snap Mode** selector to set how events “snap” to the grid.

**Absolute:** Events will “snap” to the nearest time division on the grid (as determined by the **TC** field or **Time Correct** window). This is the typical and traditional method of using the snap/quantization feature.

**Relative:** Events will “snap” to the nearest time division on the grid (as determined by the **TC** field or **Time Correct** window) **plus** the original time position of the event (e.g., an event that is originally three ticks past a time division on the grid will snap only to positions that are three ticks past every time division).

Use the **Auto-Scroll** selector to set how the screen behaves relative to the audio playhead.

**Follow:** Depending on the zoom setting, the waveform display will scroll along in the background while keeping the audio playhead centered.

**Page:** The waveform display will move to the “next page” to follow the audio playhead.

**Off:** The waveform display will not move at all.

These functions also apply to the sample waveform in Sample Edit Mode.

Use the **Link Zoom and Scroll** selector to turn the feature on or off. When on, the zoom and scroll levels in the MPC software and your MPC hardware will always be the same. When off, the grid views can be adjusted separately using the MPC software and your MPC hardware.

**Note:** This setting is only available when connected to MPC software in controller mode.

On the left edge of the screen, next to the five mode icons, there are two small icons that control the channel strip.

**To show or hide the channel strip**, tap the **eye icon**.

The channel strip contains some important settings for the audio track or main output, depending on the currently selected icon:

**To view the track channel strip**, tap the **waveform icon**.

**To view the main output channel strip**, tap the **crown icon**.



When viewing the **track channel strip** while using an audio track:

The first field defines the input source of the external audio signal, which you can set to a pair of inputs (**Input 1,2-3,4** in Standalone Mode, **Input 1,2-31,32** in Controller Mode) or a single input (**Input 1-4** in Standalone Mode, **Input 1-32** in Controller Mode).

The second field shows where the track is routed, which you can change: **Out 1,2-7,8**, **Out 1-8** or **Sub 1-8** in Standalone Mode; and **Out 1,2-31,32** or **Out 1-32** in Controller Mode.

**Note:** When set to a mono channel, the left and right channels are summed post-pan knob. If the pan knob is set to the center position, the left and right channels will be summed and padded. If the pan knob is set to the maximum left or right positions, only the respective channel will be sent to the output.

The **Inserts** field shows any enabled or disabled effects for that track. Tap the area under **Inserts** to open a window where you can load, change, and enable or disable the effects.

Tap **Solo** or **Mute** to solo or mute the track (respectively).

Tap the **Monitor** button to set how your audio track will be monitored. Tapping it will cycle through its three states:

When set to **Auto**, you will hear incoming audio while the track is record-enabled only.

When **on**, you will hear incoming audio whether or not the track is record-enabled.

When **off**, you will never hear any incoming audio.



Tap the **track automation button** to toggle between the two states. Alternatively, press **Read/Write** (MPC X, MPC Key 61) or **Automation** (MPC Key 37).

When set to **Read (R)**, the audio track will read automation data but will not record any additional automation over it. (Think of this as a protective feature to prevent accidental changes to your automation while recording.)

When set to **Write (W)**, the audio track can record automation. (If you have any Q-Link knobs assigned to automatable parameters, make sure not to touch any accidentally while you are recording.)

**Tip:** You can quickly set all programs and audio tracks to the same automation by tapping the global automation button in the upper-right corner of the screen. See [General Features > Automation](#) to learn about this.

Press and hold **Shift** and tap the **track automation button** to disable track automation. Alternatively, press **Shift+Read/Write** (MPC X, MPC Key 61) or **Shift+Automation** (MPC Key 37). When **off**, the audio track will ignore automation data. Tap the **track automation button** or press **Read/Write** to enable track automation again.

**Important:** If you have already recorded automation and turn it off, the track will still use the effect and its parameter values at the point where you turned it off.

To change the panning or level of the track, adjust the **pan knob** or **level slider**.

To record-enable the track, tap the **Record Arm** button or press **Rec Arm** (on MPC X when the track name is shown in the display strip below the **level meters**). When you begin audio recording, the audio signal will be recorded to this track.

**Tip:** You can select multiple tracks in the Track View by pressing and holding **Shift** while tapping the **Arm** button to each track.



When viewing the **main output channel strip**:

The first field shows the current main output as a stereo pair (which you can change).

The **Inserts** field shows any enabled or disabled effects for that pair of outputs. Tap the area under **Inserts** to open a window where you can load, change, and enable or disable the effects.

Tap **Mute** to mute the main output.

Adjust the **pan knob** or **level slider** to change the panning or level of the main output.

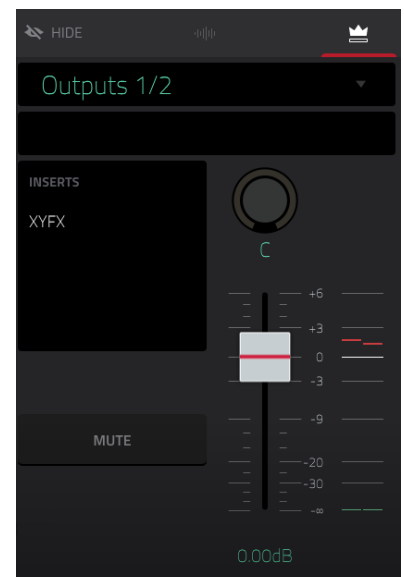

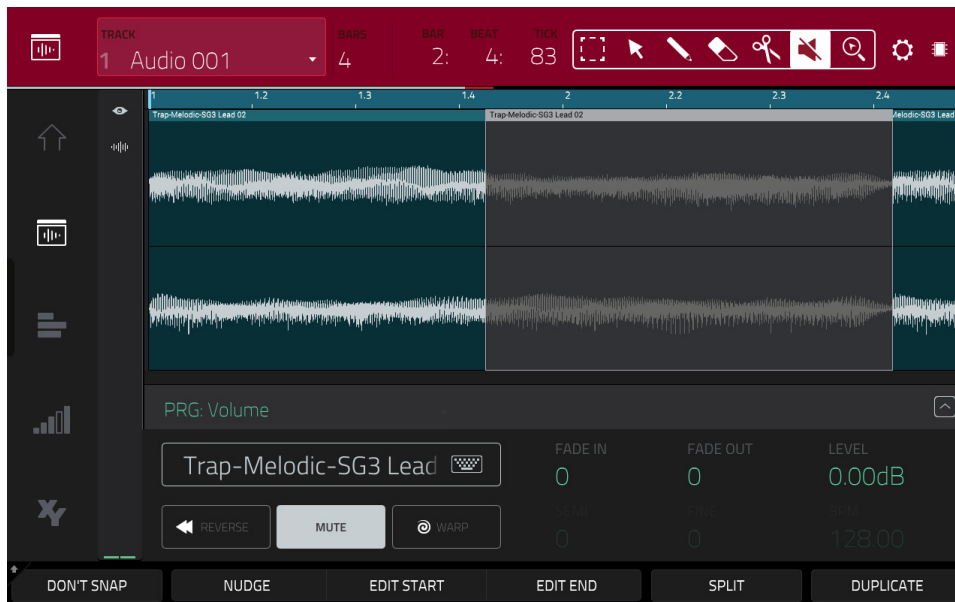

Regardless of which tool is selected, you can do any of the following to edit the selected audio track regions.

**Tip:** If you want to hear only the audio track while editing, use the **Solo** button in the **track channel strip** to solo it.

**To select a track region**, tap the arrow icon to enter Selection Mode and tap a track region. When a track region is selected, all region parameters will be available to edit.

**To undo your last action**, press **Undo**.

**To redo the last action you undid**, press **Shift+Undo/Redo**.

**To move the selected track region**, tap **Nudge** at the bottom of the screen, and then use the **data dial** or **-/+** buttons to shift the track region left or right. Alternatively, if the **arrow tool** or **marquee tool** are selected, tap and drag the upper third of the selected track region left or right. By default, you can move a track region only by quantization values defined by the **Time Correct** value (see [General Features > Timing Correct \(TC\)](#) to learn about this).

**To move the selected track region without restricting** (“snapping”) **it to the quantization grid**, tap and hold **Don't Snap** in the lower-left corner of the screen, and then use the **data dial** or **-/+** buttons to shift the track region. In this case, each nudge is equivalent to four ticks.

**To adjust the start point or end point of the selected track region** (without changing its position), tap **Edit Start** at the bottom of the screen, and then use the **data dial** or **-/+** buttons.

**To split the track at the current playhead position** (creating a track region on either side), tap **Split** at the bottom of the screen.

**To copy, cut, or paste the selected track region**, press **Copy** or press and hold **Shift**, and then tap **Copy** or **Cut**. Turn the **data dial** to move the highlighted track region, and then press the **data dial**, or the **center cursor** or **Enter** (MPC X), to paste it at its current location. Alternatively, press and hold **Shift**, and then tap **Paste** (respectively).

**To cut, copy, or paste the selected track region**, press and hold **Shift**, and then tap **Cut**, **Copy**, or **Paste** (respectively) at the bottom of the screen.

**To duplicate the selected track region**, tap **Duplicate** at the bottom of the screen. The duplicate track region will appear immediately after the original one.

**To create a fade-in or fade out for the selected track region**, use the **Fade In** or **Fade Out** fields, respectively. The fades will be shown as a sloped line at the start or end of the track region.

**To set the level of the selected track region**, use the **Level** field. The waveform amplitude will change accordingly.

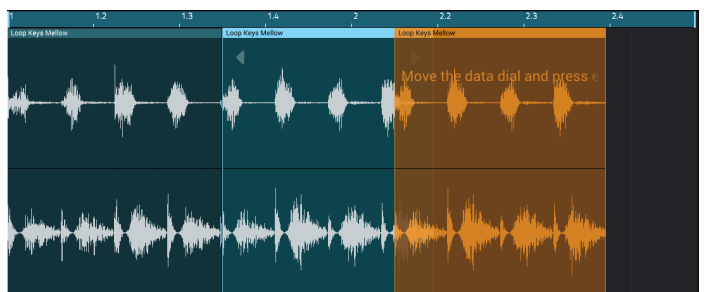

To reverse the selected track region, tap **Reverse**.

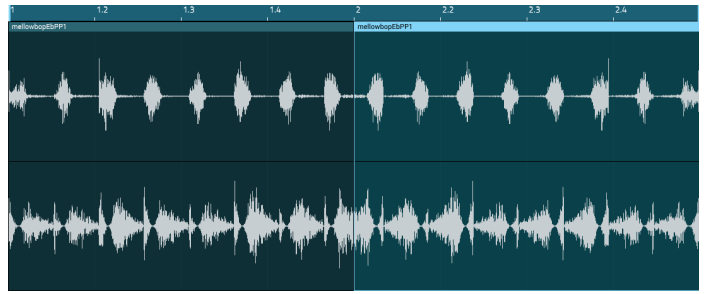

To mute the selected track region, tap **Mute**.

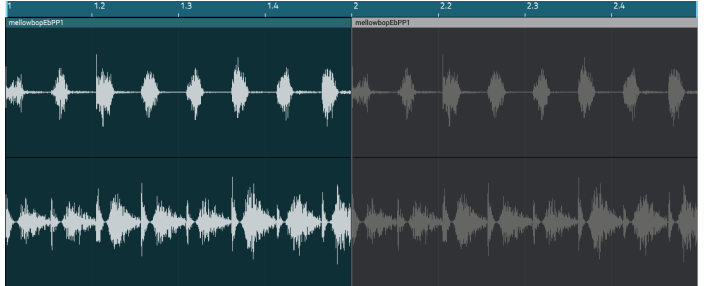

To lengthen or shorten the selected track region without changing its pitch, tap **Warp**, which will enable the **Semi**, **Fine**, and **BPM** fields next to it. Use the **BPM** field to change the tempo, which will change the length of the track region accordingly. Use the **Semi** and **Fine** fields if you want to change the pitch (this is useful for matching the durations of two samples with different pitches).

**Tip:** You can configure audio track recording to ensure the resulting track region is warped automatically. You can then adjust the sequence tempo while track region remains in time. See [Menu > Preferences > General](#) to learn about this.

**Note:** When you record an audio file, the current sequence tempo will be embedded with it. This information is stored within the sample file when you save the project. When you warp an audio track region, the warping algorithm uses this sequence tempo and the current value in the BPM field to generate the “stretch factor.”

**Note:** The Warp algorithms are very CPU-intensive and can result in audio drop-outs during playback if used too freely. Be mindful of how (and how often) you use the warp function. You can reduce the CPU resources required by doing any/all of the following:

- Minimize the amount of pitch adjustment (e.g., the **Semi** and **Fine** fields).

- Avoid warping very small track regions.

- Warp as few tracks or track regions as possible (i.e., reduce the number of total number of voices [of the polyphonic limit] that use the warp algorithm at a given time), especially instances where the warped regions start at the same time.

- If you have warped samples used in a drum program, consider using **the Flatten Pad** function to consolidate the affected pad’s layers into one audio sample (see [here](#) to learn about this). After you flatten the pad, its sample/samples no longer need to be warped.

To open the **Timing Correct** window, press and hold **Shift**, and then tap **TC** at the bottom of the screen. See [General Features > Timing Correct \(TC\)](#) to learn about this.

To switch to the previous or next track, press and hold **Shift**, and then tap **Track –** or **Track +** (respectively) at the bottom of the screen.

To mute or solo the track, press and hold **Shift**, and then tap **Mute** or **Solo** (respectively) at the bottom of the screen.

To edit automation for the track, open the automation lane. See [Addenda > Updates in MPC 2.6 > New Features > Grid Automation Lanes](#) for more information.



## Track View

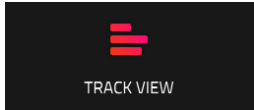

Track View gives you an overview of the tracks of each sequence. Use this mode to edit tracks and sequences simultaneously.

To enter the Track View, do either of the following:

- Press **Menu**, and then tap **Track View**.
- Press **Shift+Main/Track** (MPC X, MPC Live, MPC Key 61, MPC Key 37, MPC Touch).
- Press and hold **Mode** and press **Pad 1** (MPC Studio).

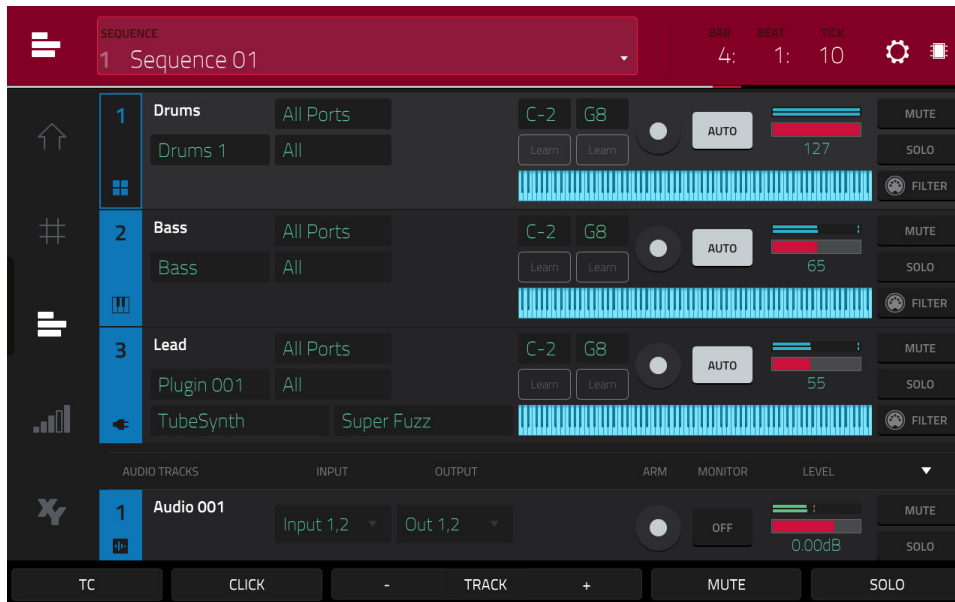

Each horizontal strip represents a track in the current sequence. MIDI tracks and audio tracks are grouped together. MIDI tracks are listed first, audio tracks are listed second.

To move through the list of tracks, swipe up or down.

To collapse or expand each group of tracks, tap the **up arrow** (▲) or **down arrow** (▼) icon above the first track's **Mute** button.

The top of the screen shows the sequence name and timing information.



Use the **Sequence** field to select which sequence contains the tracks you want to show below.

The time counter at the top of the screen indicates the current playhead position. This is shown in most of the modes. See [General Features > Time Counter/Locate](#) to learn about this.

The Settings window lets you configure certain Track View settings.

To view the **Settings**, tap the **gear icon**.

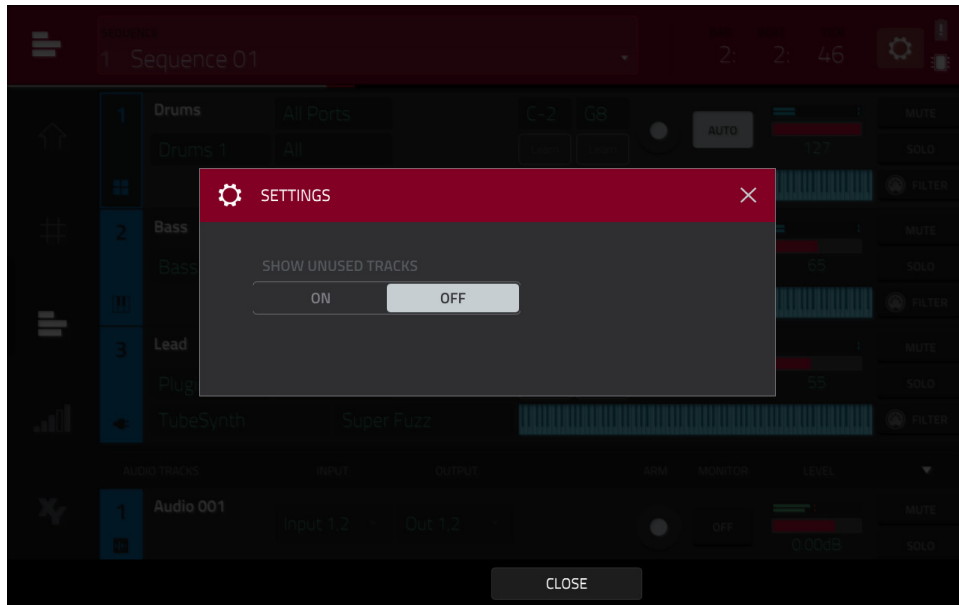

Use the **Show Unused Tracks** selector to turn this feature on or off. When **on**, tracks with a sequence, program, etc. will still appear in the Track View. When **off**, only tracks with a sequence, program, etc. will appear.

To open the **Timing Correct settings**, tap **TC** at the bottom of the screen. See [General Features > Timing Correct \(TC\)](#) to learn about this.

To open the **metronome settings**, tap **Click** at the bottom of the screen. See [General Features > Metronome \(Click/Metro\)](#) to learn about this.

To select the **previous or next track of the same type** (MIDI or audio), tap **Track -** or **Track +** (respectively) at the bottom of the screen. Alternatively, tap the track in the main part of the screen.

## MIDI Tracks

All MIDI tracks in the project are grouped together in the upper half of the Track View.

To show or hide them, tap the ▲ or ▼ arrow icon.



Use the **Input** fields to select MIDI input port and channel that the track will use.

Use the **Output** fields to select the MIDI output port and channel that the track will use. This is only available when using a MIDI Program on the track.

Use the **Key Range** fields to set the incoming range of notes that will be sent to the track. You can tap the low and high key fields and then use the **data dial** or **+/-** buttons, or tap the **Learn** button and use a connect MIDI device to set the key range. The set range will be shown in the keys diagram.

Use the **Arm** button to record-enable the track. When you begin recording, the MIDI input will be recorded to this track. You can select multiple tracks by pressing and holding **Shift** while tapping the **Arm** button to each track.

Use the **Monitor** button to set how your MIDI track will be monitored. Tapping it will cycle through its four states:

When set to **Off**, the track's MIDI input is not monitored, and playback of recorded events will be heard.

When set to **In**, the track's MIDI input is always monitored regardless of the track's Record Arm state, and playback from recorded events will not be heard.

When set to **Auto**, the track's MIDI input is monitored when the track is record armed, and playback of recorded events will be heard.

When set to **Merge**, the track's MIDI input is always monitored, and playback of recorded events will be heard.

Use the **level slider** to change the level of the track. The level meter above the slider shows the track's current level.

Use the **Solo** and **Mute** buttons to solo or mute the track (respectively).

Alternatively, tap **Mute** or **Solo** (respectively) at the bottom of the screen to mute the currently selected track.

Tap the **Filter** button to open the Track MIDI Perform Settings window, where you can set parameters for incoming MIDI data.

- **Note Range:** This determines the **Note Min** and **Note Max** range that passes MIDI. Notes outside this range will not be heard in the track. You can also adjust this directly from Track View by using the **Keyrange** fields. Tap **Learn** and press the desired note for the Min and Max values.
- **Velocity Range:** This determines the **Velocity Min** and **Velocity Max** that passes MIDI. Velocities outside this range will not be heard in the track.
- **MIDI CC Filter:** Check these boxes to allow the listed MIDI Control Change messages to pass through the track. When unchecked, the MIDI CC message type will be ignored by the track. You can filter the following MIDI CC messages:

|                     |                                   |
|---------------------|-----------------------------------|
| CC1 Modulation      | CC65 Pmento (Portamento) On/Off   |
| CC2 Breath          | CC66 Sost (Sostenuto) On/Off      |
| CC3 Undefined       | CC67 Soft Ped (Soft Pedal) On/Off |
| CC4 Foot            | CC68 Legato Switch                |
| CC5 Portamento      | CC128 Pitchbend                   |
| CC7 Volume          | CC130 Program Change              |
| CC10 Pan            | CC129 Channel Pressure            |
| CC11 Expression     | CC131 Aftertouch                  |
| CC64 Sustain On/Off |                                   |

## Audio Tracks

All audio tracks in the project are grouped together in the lower half of the Track View.

To show or hide them, tap the ▲ or ▼ arrow icon.



Use the **Input** field to set the track's input/inputs.

Use the **Output** field to set the track's output/outputs.

Use the **Arm** button to record-enable the track. When you begin audio recording, the audio signal will be recorded to this track. You can select multiple tracks by pressing and holding **Shift** while tapping the **Arm** button to each track.

Use the **Monitor** button to set how your audio track will be monitored. Tapping it will cycle through its three states:

When set to **Auto**, you will hear incoming audio while the track is record-enabled only.

When **on**, you will hear incoming audio whether or not the track is record-enabled.

When **off**, you will never hear any incoming audio.

Use the **level slider** to change the level of the track. The level meter above the slider shows the track's current level.

Use the **pan knob** to change the panning of the track.

Use the **Solo** and **Mute** buttons to solo or mute the track (respectively).

Alternatively, tap **Mute** or **Solo** (respectively) at the bottom of the screen to mute the currently selected track.

Use the **Add new audio track** button to create a new audio track.

## Step Sequencer

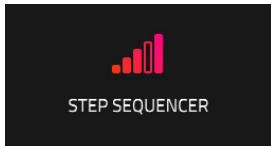

The Step Sequencer lets you create or edit sequences by using the pads as “step buttons,” simulating the experience of a traditional step-sequencer-style drum machine. This is available for MIDI tracks only, not audio tracks.

You can also create and edit automation using the Step Sequencer. See [Addenda > Updates in MPC 2.6 > New Features > Step Automation](#) for more information.

To enter the Step Sequencer, do either of the following:

- Press **Menu**, and then tap **Step Sequencer**.
- Press **Step Seq** (MPC X, MPC Live II, MPC One) or **Shift+Grid/Step Seq** (MPC Key 61, MPC Key 37).
- Press and hold **Mode** and press Pad 15 (MPC Studio).



The top of the screen shows the track name and information as well as sequence and timing information.



The **Track** field shows the name of the current track.

Use the **Track Length** field to set how long the track is. If you select the minimum value, **Sequence** or **0** (if you use the numeric keypad), the track will be the exact same length as its sequence.

**Tip:** This feature lets you maintain tracks of different lengths. For instance, you could play a 1-bar drum sequence repeatedly under a 4-bar bass line.

Use the **Bars** field to adjust the length of the sequence in bars.

Use the **BPM** field to adjust the tempo of the sequence.

To set whether the sequence follows its own tempo (**Seq**) or a global tempo (**Gbl**), tap the **Seq/Gbl** button next to the BPM field. Alternatively, press and hold **Shift** and then press **Tap**.

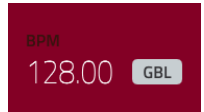

The time counter at the top of the screen indicates the current playhead position. This is shown in most of the modes. See [General Features > Time Counter/Locate](#) to learn about this.

Use the **Time Division** selector to set the value that determines how many steps each bar of the sequence will have. The **T** indicates a triplet-based value.

Alternatively, tap **TC** at the bottom of the screen to open the **Timing Correct** window. See [General Features > Timing Correct \(TC\)](#) to learn about this.



### To enter or delete steps in a sequence:

1. Use the **Pad -/+** buttons at the bottom of the screen to select the pad whose steps you want to enter or delete. The current pad number is shown in the upper-left corner.

Alternatively, use the Pad Select feature: Tap and hold **Pad Sel**, press the desired pad, and then release **Pad Sel**. You can also use Pad Select as a “latching” feature: tap **Pad Sel** so it is activated, press the desired pad, and then tap **Pad Sel** once more so it is deactivated.

2. Use the **Bar -/+** buttons at the bottom of the screen to select the bar of the sequence whose steps you want to enter or delete. The current bar number is shown in the upper-left corner.

3. Press the **pads** of your MPC hardware, or tap a button at the bottom of the sequencer. Each pad corresponds to a step in the bar and will light with a color corresponding to its velocity.

Keep in mind that for time divisions larger than 16, the bar’s steps will be represented by multiple pad banks. In this case, use **Pad Bank Buttons A** and **B** to view all the steps within a bar.

For time divisions larger than 16, the bar’s steps will be represented by multiple pad banks. In this case, use the left and right arrows (< and >) by the step numbers (**1-16**, **17-32**, etc.) to change which steps are shown in the sequencer.

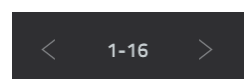

Alternatively, use **Pad Bank Buttons A** and **B**.

To adjust the velocities of the steps, do any of the following:

- Tap anywhere on the **velocity bar** of a step. The top of the velocity bar will jump to that point.
- Use the **slider** on the right edge of the screen to increase or decrease the velocities of all steps.
- Turn the **Q-Link knob** that corresponds to that step (the Q-Link knobs must be in the **Screen** edit mode). Setting a value of **0 (Off)** will delete the step.

Use the **Nudge <** and **Nudge >** arrows to shift each step left or right (respectively) one step. This is useful for experimenting with different rhythmic permutations.

Use the **slider** on the right edge of the screen to increase or decrease the velocities of all steps.

Use the **Flip Steps** button to switch which steps have notes entered and which do not have notes. Steps that previously had no notes will now have notes at full velocity (**127**). Steps that previously had notes will now be empty.

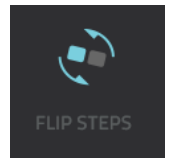

Tap **Presets** to show or hide the preset sequence controls. These controls let you manipulate and transform the velocities of the current bar in the sequence.

The **first** button will apply ascending or descending velocities to the steps. Each time you tap it, it will cycle through these options:

- The velocities will ascend to a single peak at the end of the bar.
- The velocities will ascend to two peaks—one after each half of the bar.
- The velocities will ascend to four peaks—one after each quarter of the bar.
- The velocities will descend from a single peak at the start of the bar.
- The velocities will descend from two peaks—one after each half of the bar.
- The velocities will descend from four peaks—one at the start each quarter of the bar.

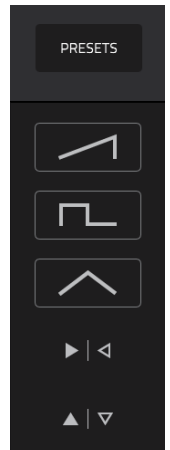

The **second** button will set the velocities of the steps to be at the maximum value (**127**) or minimum values (**1**), depending on their position in the bar. Each time you tap it, it will cycle through these options:

- The velocities of the first half of the bar will be set to **1**. The velocities of the second half will be set to **127**.
- The velocities of the first and third quarters of the bar will be set to **1**. The velocities of the second and fourth quarters will be set to **127**.
- The velocities of the first, third, fifth, and seventh eighths of the bar will be set to **1**. The velocities of the second, fourth, sixth, and eighth eighths will be set to **127**.
- The velocities of the first half of the bar will be set to **127**. The velocities of the second half will be set to **1**.
- The velocities of the first and third quarters of the bar will be set to **127**. The velocities of the second and fourth quarters will be set to **1**.
- The velocities of the first, third, fifth, and seventh eighths of the bar will be set to **127**. The velocities of the second, fourth, sixth, and eighth eighths will be set to **1**.



The **third** button will apply ascending or descending velocities to the steps. Each time you tap it, it will cycle through these options:

- Across the entire bar, the velocities will ascend to a peak and then descend from it.
- In each half of the bar, the velocities will ascend to a peak and then descend from it.
- In each quarter of the bar, the velocities will ascend to a peak and then descend from it.
- Across the entire bar, the velocities will descend from a peak into a valley and then ascend back up to the peak.
- In each half of the bar, the velocities will descend from a peak into a valley and then ascend back up to the peak.
- In each quarter of the bar, the velocities will descend from a peak into a valley and then ascend back up to the peak.

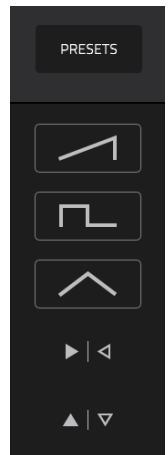

The **fourth** button will swap the first half and second half of the bar. In other words, the first half of the bar will become a mirrored image of the second half, and vice versa.

The **fifth** button will invert the velocities of all steps with entered notes. The sum of the old and new velocities will equal **127**. The exception is a velocity of **127** or **1** as a step with a note cannot have a velocity of **0**.

**Examples:**

Steps with velocities of **40** will now have velocities of **87**, and vice versa.

Steps with velocities of **75** will now have velocities of **52**, and vice versa.

Steps with velocities of **127** will now have velocities of **1**, and vice versa.

## XYFX Mode

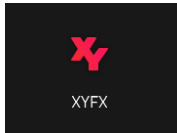

XYFX Mode turns the touchscreen into an XY pad where each axis represents the range of an effect parameter. As you move your finger on the XY pad, the current position will determine the current value of the two parameters. You can use this mode to create interesting effect automation on your tracks.

The effect you control in XYFX Mode acts like an insert effect on that program. In fact, **XYFX** is the name of the insert effect you have to load to the program before you can use this mode. Learn more about this in [General Features > Effects](#).

To enter **XYFX Mode**, do any of the following:

- Press **Menu**, and then tap **XYFX**.
- Press **XYFX** (MPC X), **Shift+Next Seq/XYFX** (MPC Live II, MPC One), or **Shift+Edit/XYFX** (MPC Key 61, MPC Key 37).

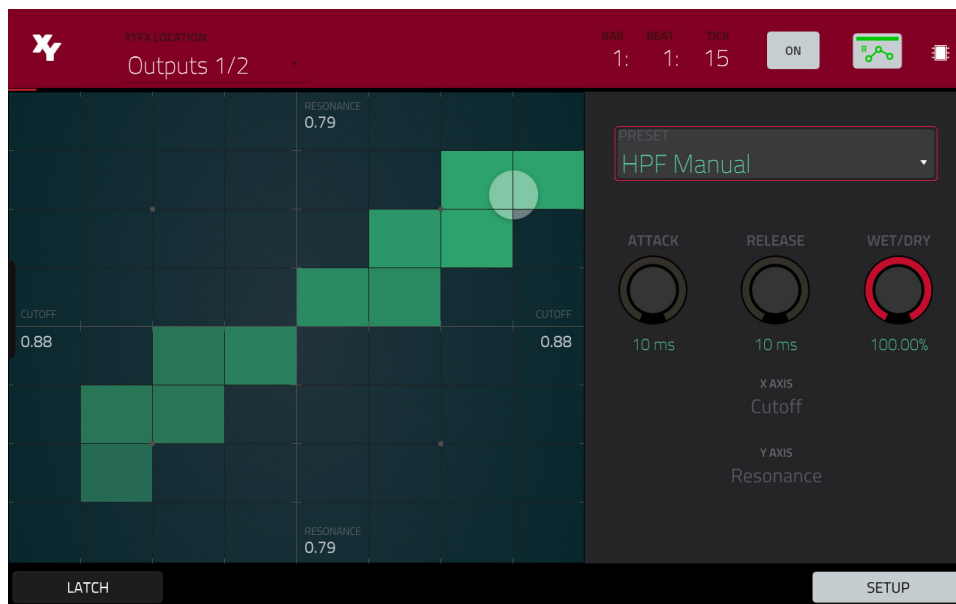

When you first enter this mode in a project, you may be prompted to load XYFX to the program. Tap **Insert XYFX** to do this.

**Note:** If you already have four insert effects loaded, you will need to clear one of the insert effect slots before doing this.

Use the **XYFX Location** field to select the signal to which the effects will be applied: the current program (**Program**) or a main output (a stereo pair of channels: **Output 1/2**, **Output 3/4**, etc.).

The time counter in the upper-right corner shows the current playhead position. This is shown in most of the modes. See [General Features > Time Counter/Locate](#) to learn about this.

The automation button indicates the global automation state. This is shown in several modes. See [General Features > Automation](#) to learn about this.

Touch or move your finger on the gridded part of the screen. A marker will follow your finger to indicate the current position. The X axis is the horizontal axis, increasing in value as you move right. The Y axis is the vertical axis, increasing in value as you move up. Each axis is labeled with its assigned parameter.

When an effect has a beat division parameter, the current division will be highlighted as an entire column.

Effects are differently colored for easy visual distinction: beat-synchronized effects are **blue**, while manually controlled effects are **green**.

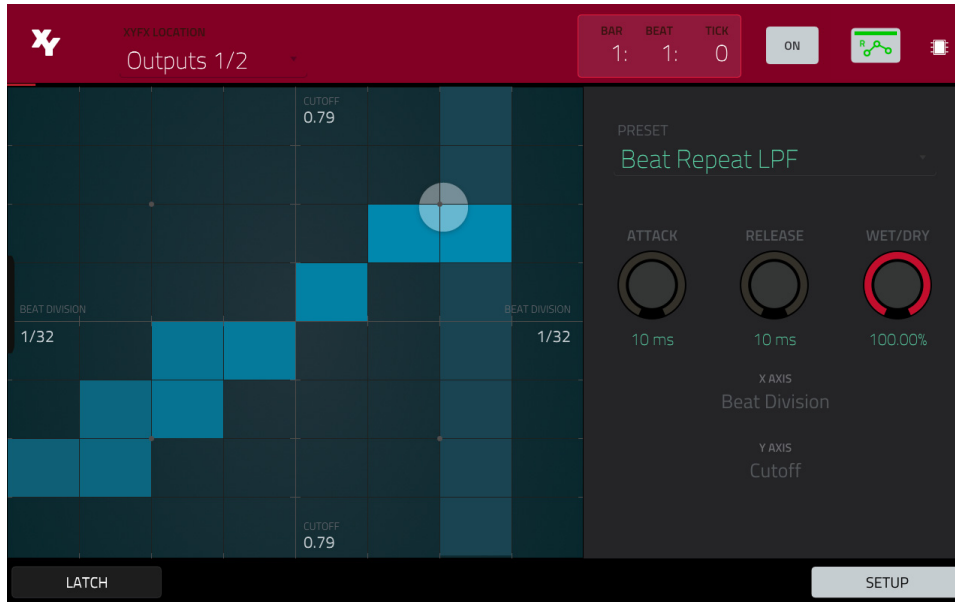

XY Mode with a beat-synchronized effect.

While touching the **XY pad**, tap **Latch** in the lower-left corner to keep the marker on the XY pad even after you release it. The marker will remain there until you touch another part of the XY pad or until you tap **Latch** again.

Use the **Setup** button to show or hide the Setup panel, which controls how the XY pad behaves.

Use the **Preset** field to select the effect you want to use in XYFX Mode.

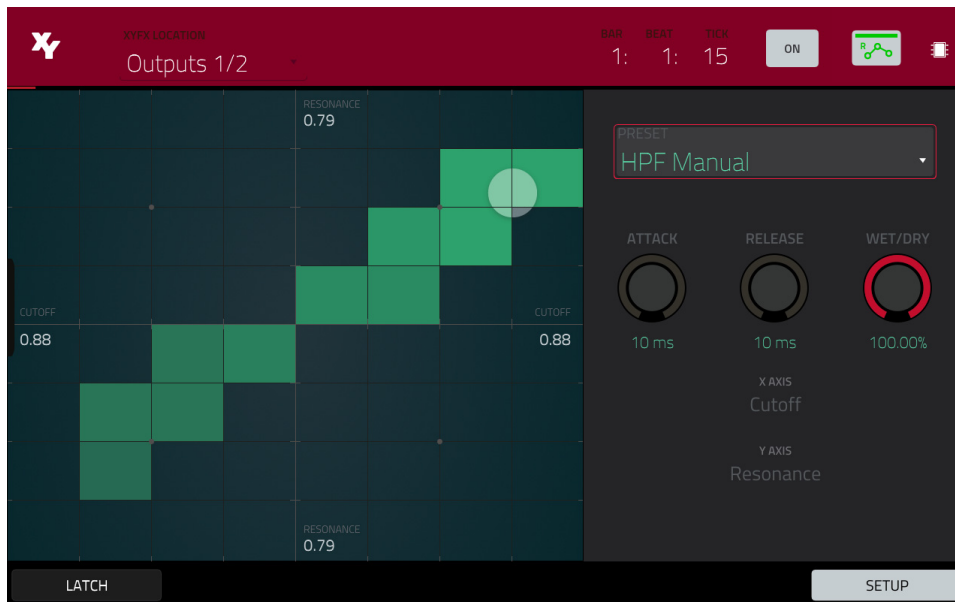

XY Mode with a manually controlled effect.

Use the **Attack** knob to set the length of the attack phase of the envelope, which is triggered when you touch the XY pad. In other words, this determines how long it takes the effect to fully respond to your touch.

Use the **Release** knob to set the length of the release phase of the envelope, which is triggered when you release the XY pad. In other words, this determines how long it takes the effect to fully deactivate after you stopping touching the XY pad.

Use the **Wet/Dry** knob to set the blend the original signal (dry) and the effect signal (wet).

The **X Axis** and **Y Axis** fields show which parameters are controlled by each axis. This varies depending on the effect you are using.

## Sample Edit Mode

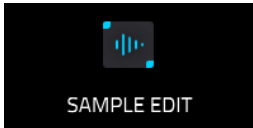

Sample Edit Mode lets you edit samples using various functions.

To enter **Sample Edit Mode**, do any of the following:

- Press **Menu**, and then tap **Sample Edit**.
- Press **Sample Edit** (MPC X, MPC One, MPC Key 61, MPC Key 37) or **Shift+Mute/Sample Edit** (MPC Live II).
- Press and hold **Mode** and press **Pad 5** (MPC Studio).

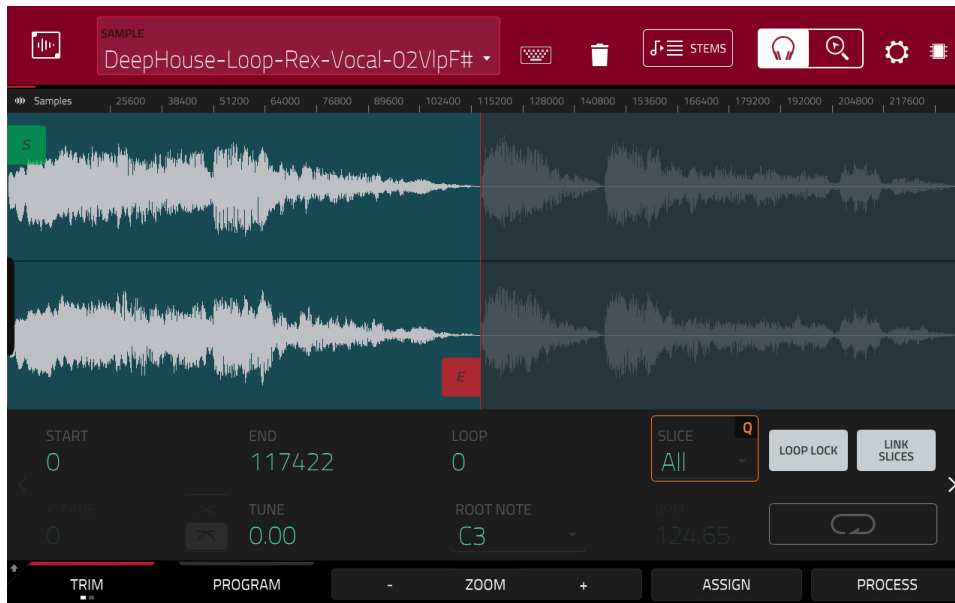

To select a sample to edit, do any of the following:

- Use the **Sample** field at the top of the screen.
- In Main Mode, tap the **Project** field at the top of the screen, and then double-tap a sample in the list on the right side.
- In the Browser, tap the **Project** button with the **P/page icon** at the bottom of the screen, and then double-tap a sample in the list on the right side.
- Press **Sample Select** and use the **data dial** or **-/+** buttons to select a sample (MPC Studio).

To edit the name of the sample, tap the **keyboard icon** next to the name at the top of the screen, and use the virtual keyboard that appears.

To delete the sample, tap the **trash-can icon** next to the name at the top of the screen. In the screen that appears, you will see the programs that use this sample within your project. Tap **Delete Sample** to continue, or tap **Cancel** to return to the previous screen.

To create stems of a sample, tap the **Stems** button. This will open the Process Slice window with the Create Stems function selected, which you can use to split any track into distinct stems: vocals, bass, drums, and other instrumental elements. See [Trim Mode > Processing Slices & Samples](#), [Chop Mode > Processing Slices](#), or [Program Mode > Processing Slices](#) to learn more about how to use this function. See [Addenda > Updates in MPC 2.15 > New Features > Stem Separation](#) to learn more about how to get Stems.

The upper half of the screen shows the waveform. The lower half shows the editing controls.

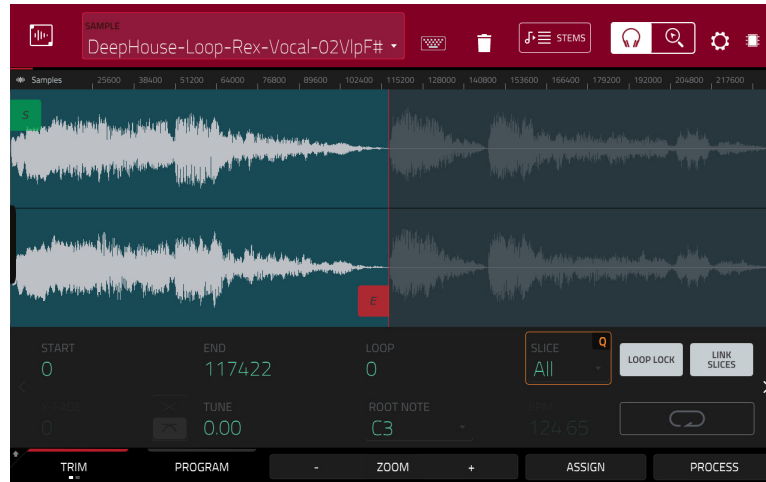

The waveform display shows the “active” section of the sample waveform. Swipe left or right on the waveform to move through it.

Above the waveform is the timeline, shown in **Samples**, **Time** (in seconds and milliseconds), or **Beats**. You can select the measurement units you want to show in the [Settings](#).

**To zoom in or out**, do any of the following:

- When the **magnifying-glass icon** (in the upper-right corner) is selected, spread or pinch your fingers (respectively) on the waveform.
- Tap the **Zoom +** or **Zoom –** buttons (respectively) at the bottom of the screen.
- Turn **Q-Link Knob 4 (Zoom)** on MPC X) or the **fourth Q-Link knob** in the **fourth column** (MPC Live/Live II/One/Key 61/Key 37/Touch).
- Press **Zoom** and use the **data dial** or **-/+** buttons (MPC Studio).

**To scroll through the waveform**, do either of the following:

- When the **magnifying-glass icon** (in the upper-right corner) is selected, swipe the waveform left or right.
- Turn **Q-Link Knob 8 (Scroll)** on MPC X) or the **third Q-Link knob** in the **fourth column** (MPC Live/Live II/One/Key 61/Key 37/Touch).

The green marker and red marker are the start point and end point (respectively). These two points define the region of the sample that will be played.

**To move the start point or end point of the selected region**, do any of the following:

- Tap and drag its marker left or right.
- Use the **Start** or **End** fields shown below the waveform.
- Use the **first** column of **Q-Link knobs (Start X1\_\_)** to adjust the start point or the **second** column of **Q-Link knobs (End X1\_\_)** to adjust the end point. The top-most **Q-Link knobs (13 and 14)** provide coarse adjustment. The bottom-most **Q-Link knobs (1 and 2)** provide fine adjustment.
- Press **Sample Start** or **Sample End** and use the **data dial** or **-/+** buttons (MPC Studio).

**Tip:** A recorded sample may have some silence at the beginning or end, which makes it difficult to time it correctly in a musical context. Fix this by adjusting the start point. You can also adjust end point to remove any extra silence or unwanted audio at the end. In addition to making your workflow easier, having a “tight,” well-edited sample can enhance your production or performance.

You can use Sample Edit Mode in three different ways: **Trim Mode**, **Chop Mode**, or **Program Mode**. The options for each mode are slightly different. Please refer to the following [Trim Mode](#), [Chop Mode](#), and [Program Mode](#) parts of this chapter to learn how each works. Before using these modes, though, you may want to configure your settings—see the following [Settings](#) chapter to do this.

## Settings

The Settings window lets you configure certain Sample Edit Mode settings.

To view the **Settings**, tap the **gear icon**.

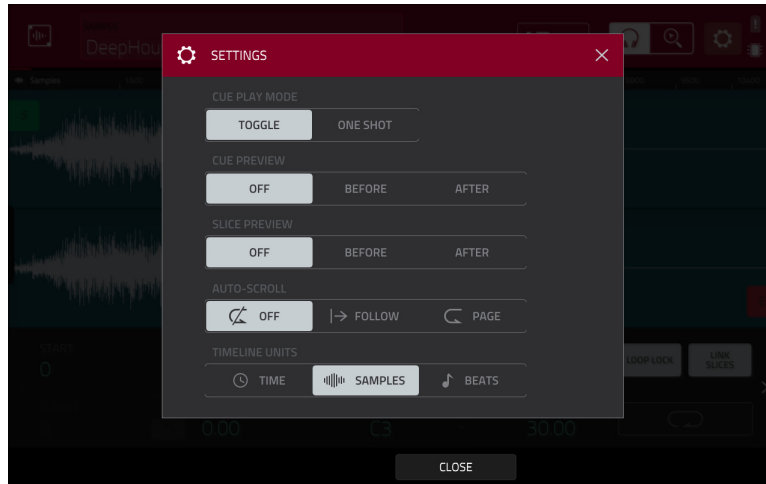

Use the **Cue Play Mode** selector to set how the cue playhead will play audio.

**One Shot:** Tapping **Play Cue** will play the entire sample from the cue playhead.

**Toggle:** Tapping **Play Cue** once will start playback from cue playhead. Tapping it once more will stop playback.

Use the **Cue Preview** selector to set if any audio plays as you move the cue playhead. As you move the cue playhead through the sample waveform, you can set it to play the small part of the sample before the cue playhead (**Before**), play the small part of the sample after the cue playhead (**After**), or not play at all (**Off**). You can also set this in your overall Preferences (see [General Features > Menu > Preferences > General](#)).

Use the **Slice Preview** selector to set if any audio plays as you move a slice marker. As you move the slice marker through the sample waveform, you can set it to play the small part of the sample before the slice marker (**Before**), play the small part of the sample after the slice marker (**After**), or not play at all (**Off**). You can also set this in your overall Preferences (see [General Features > Menu > Preferences > General](#)).

Use the **Auto-Scroll** selector to set how the screen behaves relative to the audio playhead.

**Follow:** Depending on the zoom setting, the waveform will scroll along in the background, keeping the audio playhead centered.

**Page:** The waveform display will move to the “next page” to follow the audio playhead.

**Off:** The waveform display will not move at all.

These functions also apply to the sample waveform in the Grid View.

Use the **Timeline Units** selector to set the measurement units shown above the sample waveform. You can select one of the following options:

**Time:** hours:minutes:seconds:frames

**Samples:** number of samples

**Beats:** bars:beats:ticks

## Trim Mode

We recommend using Trim Mode to crop the start and/or ends from a sample.

**To enter Trim Mode**, tap the **Trim/Chop** button in the lower-left corner so it says **Trim**. There are two pages of parameters in Trim Mode, which can be accessed by tapping the > or < arrows on the sides of the page.

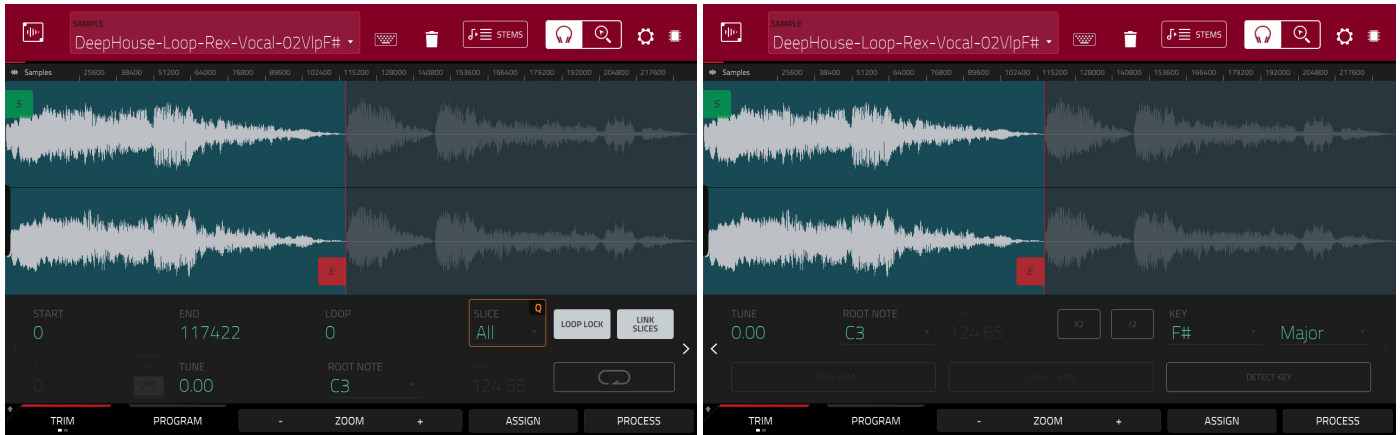

Use the **Start** and **End** fields to set the position of the start point and end point of the sample (respectively). Alternatively, tap and drag the start (**S**) or end (**E**) marker left or right, or use the **first** column of **Q-Link knobs (Start X1\_\_)** to adjust the start point or the **second** column of **Q-Link knobs (End X1\_\_)** to adjust the end point.

Trim Mode includes a loop function. When on, the region of the sample between the loop point and end point will repeat. This is useful when trying to find an ideal spot to begin the sample. The loop cannot be earlier than the start point.

**To adjust the loop point**, do any of the following:

- Use the **Loop** field.
- Tap and drag the start (**S**) marker (if **Loop Lock** is on) or the **loop** marker (if **Loop Lock** is off).
- Use the **first** column of **Q-Link knobs (Start X1\_\_)**; if **Loop Lock** is on) or the **third** column of **Q-Link knobs (Loop X1\_\_)**; if **Loop Lock** is off). The top-most **Q-Link knobs (13 and 15)** provide coarse adjustment. The bottom-most **Q-Link knobs (1 and 3)** provide fine adjustment.
- Press and hold **Shift** and press **Sample Start**, then use the **data dial** or **-/+** buttons (MPC Studio).

**To turn Loop Lock on or off**, tap the **Loop Lock** button. When on, the loop point is the same as the start point. When off, the loop point is independent from the start point and indicated by a separate loop marker.

**To turn the loop function on or off**, tap the **Loop** button to cycle between the four modes:

**Off:** The sample will not loop.

**Forward:** When the loop reaches its end point, it will start playing again from the loop point.

**Reverse:** When the loop reaches its end point, it will play in reverse. When it reaches the loop point again, it will return to the end point and continue playing in reverse.

**Alternating:** When the loop reaches its end point, it will play in reverse. When it reaches the loop point again, it will start playing forward again from the loop point.

**To switch between Forward and off**, press and hold **Shift**, and then tap **Loop** at the bottom of the screen.

Use the **X-Fade** button to apply a crossfade to a looping sample. See [Addenda > Updates in MPC 2.3 > New Features > Crossfade Looping](#) for more information about this.



Use your MPC hardware pads to play certain parts of the selected sample:

|   |                                       |                                     |                                       |
|---|---------------------------------------|-------------------------------------|---------------------------------------|
| Play Loop<br><b>13</b>                  | Play to Loop Start<br><b>14</b>       | Play from Loop Start<br><b>15</b>   | Play Loop Continuous<br><b>16</b>     |
| Play All<br><b>09</b>                   | Play Sample (One Shot)<br><b>10</b>   | Play Sample (Note On)<br><b>11</b>  | No function<br><b>12</b>              |
| Play from Start (Note On)<br><b>05</b>  | Play to Start (Note On)<br><b>06</b>  | Play to End (Note On)<br><b>07</b>  | Play from End (Note On)<br><b>08</b>  |
| Play from Start (One Shot)<br><b>01</b> | Play to Start (One Shot)<br><b>02</b> | Play to End (One Shot)<br><b>03</b> | Play from End (One Shot)<br><b>04</b> |

**Play Sample (One Shot) (Pad 10)** plays the sample once from the start point to the end point. Press the pad once to play it.

**Play Sample (Note On) (Pad 11)** plays the sample once from the start point to the end point. Press and hold the pad to play it, and release the pad to stop playing it. Alternatively, select the **headphones icon** in the upper-right corner, and then tap and hold your finger on the waveform.

**Play Loop Continuous (Pad 16)** plays the sample repeatedly using the mode set by the **Loop** button (**Forward**, **Reverse**, or **Alternating**; if the **Loop** button is **off**, the sample will loop forward repeatedly).

**Play Loop (Pad 13)** plays the sample repeatedly using the mode set by the **Loop** button (**Forward**, **Reverse**, or **Alternating**; if the **Loop** button is **off**, the sample will loop forward repeatedly). Press and hold the pad to play it, and release the pad to stop playing it.

**Play to Loop Start (Pad 14)** plays the part of the sample just before the loop point. Press and hold the pad to play it, and release the pad to stop playing it.

**Play from Loop Start (Pad 15)** plays the sample from the loop point to the end of the sample regardless of the end point. Press and hold the pad to play it, and release the pad to stop playing it.

**Play All (Pad 9)** plays the entire sample.

**Pads 1–4** have the same respective functions as **Pads 5–8**, but **Pads 1–4** play the sample part as “**One Shots**” (pressing the pad once will play the entire part) while **Pads 5–8** play the sample part as “**Note Ons**” (pressing the pad and holding it will play the part; releasing it will stop playback):

**Play from Start (Pad 1, Pad 5)** plays the sample from the start point to the end point.

**Play to Start (Pad 2, Pad 6)** plays the part of the sample just before the start point to the start point.

**Play to End (Pad 3, Pad 7)** plays the part of the sample just before the end point to the end point.

**Play from End (Pad 4, Pad 8)** plays the part of the sample from the end point to the end of the sample.

Use either of the **Tune** fields to transpose the sample up or down from its original pitch. Alternatively, press **Tune** and use the **data dial** or **-/+** buttons (MPC Studio only) to change the coarse tuning. Press and hold **Shift** and then press **Tune** and use the **data dial** or **-/+** buttons (MPC Studio only) to change the fine tuning.

Use either of the **Root Note** fields to set the root note of the sample. This defines which note will play the sample at its original pitch when in a keygroup program.

Use either of the **BPM** fields to manually set the BPM of the sample. On the second Trim Mode page, use the **X2** and **/2** buttons to double or halve the current tempo.

Tap **From BPM** to open the **Edit Tuning** window, which lets you tune a sample to the current sequence.

Use the **Beats** field to match the number of beats in the sequence.

**To tune the sample to the sequence, tap Match.** The **Tune** field will adjust automatically and close the window. The sample is now tuned to the sequence.

**To tune the sample to the sequence and adjust the sequence tempo, tap To Sequence.** This is the same as tapping Match but it also changes the sequence's tempo to the BPM shown in the Tempo field on the right.

**To close the window, tap Close.**

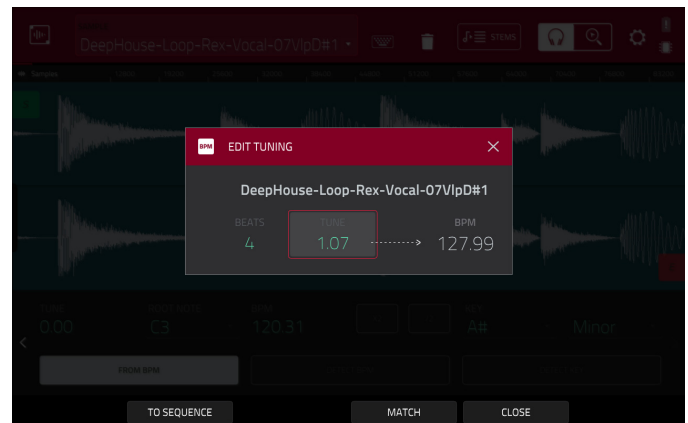

**To enter a tempo manually, use the BPM field.**

**To detect the tempo automatically, tap Detect BPM.** In the **Edit BPM** window that appears, you can do any of the following:

- Use the **BPM** field to enter a tempo manually.
- Tap **Detect** to detect the tempo automatically.
- Tap **Tempo** at the bottom of the screen at the desired rate to use it as the tempo. You can play a sequence in the background to help with your timing.
- Tap **Close**, the **X**, or anywhere outside the window to close it.

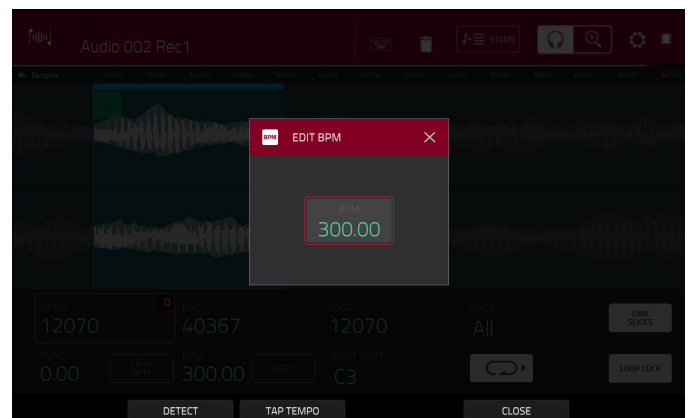

**Note:** Before detecting tempo, it is recommended that you **Normalize** samples for best results.

**To enter a sample key manually, use the Key fields.** One field selects the key root note, and the other field selects whether the key is **Major**, **Minor** or off (--).

**To detect the key automatically, tap Detect Key.**

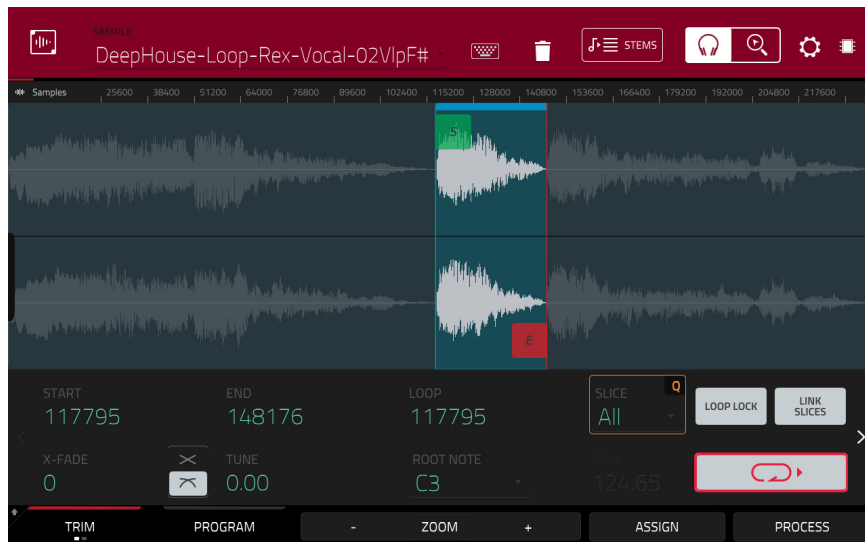

To select a slice to edit, do either of the following (after you have created slices in Chop Mode):

- Use the **Slice** field.
- Turn **Q-Link Knob 16 (Select Slice)** on MPC X) or the **fourth Q-Link knob** in the **fourth column** (MPC Live/Live II/One/Key 61/Key 37/Touch).

When **Link Slices** is enabled (after you have created slices in Chop Mode), changing the start point of a slice will also change the end point of the previous slice. Similarly, changing the end point of a slice will also change the start point of the next slice. Disable **Link Slices** if you are trying to create slices that use non-contiguous parts of the sample.

To enable or disable this feature, tap the **Link Slices** button.

**Important:** **Link Slices** must be disabled to make slices nonsequential, noncontiguous, or overlapping.

**0 Snap** forces start points, end points, and loop points to occur only at the waveform's "zero-crossings." This can help to avoid clicks and glitches when playing a sample.

To enable or disable **0 Snap**, press and hold **Shift**, and then tap **0 Snap** at the bottom of the screen.

To enable or disable the loop function, press and hold **Shift**, and then tap **Loop** at the bottom of the screen. This switches the loop function between **Forward** and **off**. The loop function is described [earlier](#).

**Tip:** You can use Trim Mode for a specific slice of the sample, previously created and selected in Chop Mode. This allows for a more detailed view of a single slice than in Chop Mode and gives you more options for auditioning the slice. You can easily switch between Trim Mode and Chop Mode while doing this.

To use both Trim Mode and Chop Mode to edit a sample slice:

1. Tap **Trim/Chop** at the bottom of the screen so it says **Chop**.
2. Set all fields as desired to create your sample slices.
3. Select the desired slice.
4. Tap **Trim/Chop** at the bottom of the screen so it says **Trim**. The region you are now editing is indicated by the normal start point and end point markers rather than slice markers.
5. Tap **Trim/Chop** at any time to return to Chop Mode.

## Assigning Samples

You can assign your new sample directly to a pad from Trim Mode.

**To assign a sample**, tap **Assign** at the bottom of the screen to open the Assign Sample window.

**Important:** Assigning a sample to a pad in this way will replace the sample on the first layer of the pad.

If you set the **Assign To** field to **Assign slice to a pad**, the pad will simply refer to the slice in this sample instead of creating a new sample. This is useful for reducing clutter in your project.

Use the **Pad** field to select the desired pad. Alternatively, press the desired pad.

Use the **Slice Type** field to select how the pad's layer settings will be set when the slice is assigned to it (see [Program Edit Mode](#) to learn more about the parameters mentioned below):

**Non-Destructive Slice:** The pad's **Slice** setting will be set to the slice number.

**Pad Parameters:** The pad's **Slice** setting will be set to **Pad**. The **Pad Start** and **Pad End** will be set to the slice's start point and end point values, and the **Loop Position** will be set to the slice's start point but with **Pad Loop** deactivated.

Use the **Program** field to specify the program to which you want to add the slice.

**To assign the sample**, tap **Do It**.

**To cancel the operation**, tap **Close**, the **X**, or anywhere outside the window.

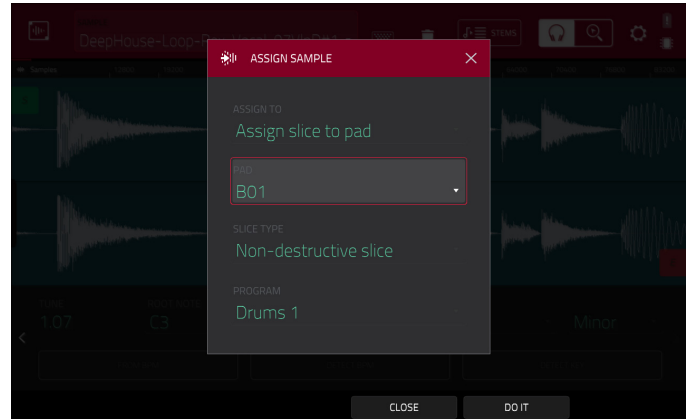

If you set the **Assign To** field to **Make new sample**, this will create a new sample in your project. (The original sample will remain as it is.)

Use the **Pad** field to select the desired pad. Alternatively, press the desired pad.

Check the **Crop Sample** box to delete the unused parts from the sample when it's created and assigned. This feature is destructive, though the project will still contain your original sample.

Leave this box unchecked to keep the unused parts of the sample when it is created and assigned. This way, you will still be able to edit the entire sample further even though you are using only part of it at the moment.

Use the **Program** field to specify the program to which you want to add the slice.

**To assign the sample**, tap **Do It**.

**To cancel the operation**, tap **Close**, the **X**, or anywhere outside the window.

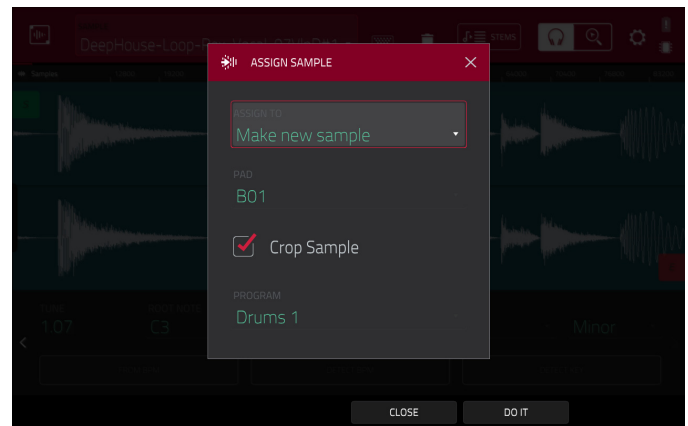

## Processing Slices & Samples

Tap the **Process** button to open the Process window, where you can select an editing option for the sample.

Use the **Function** field to select an editing process. Double-tap it or tap **Function** at the bottom of the screen to open the Function window, which displays an overview of all available editing processes.

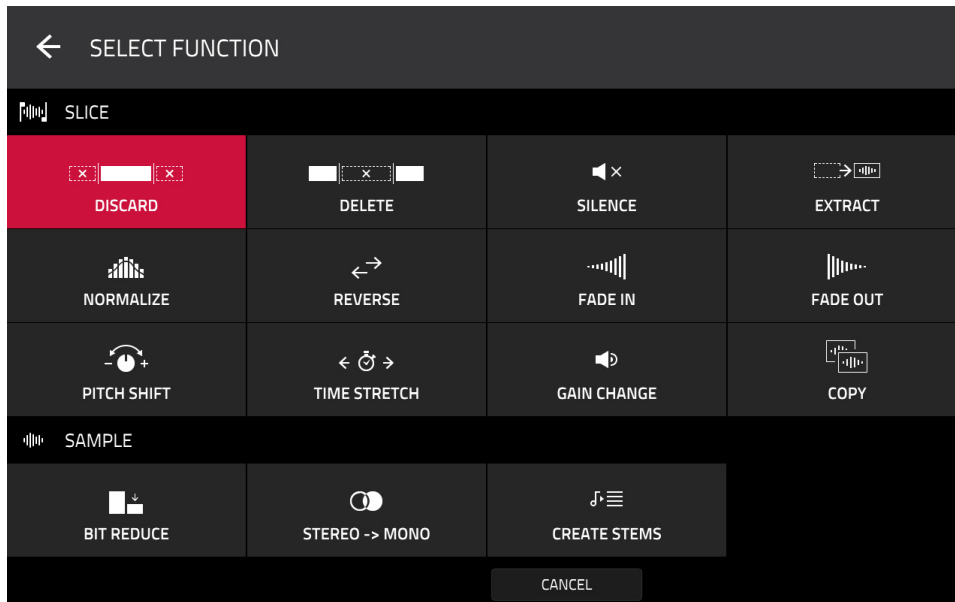

You can use any of these functions as described below.

**To return to Sample Edit Mode**, tap **Cancel**.

**To return to the Process window**, tap the top of the screen.

**Note:** All **Slice** processes will affect only the part of the sample between the start point and the end point. The **Sample** processes (**Bit Reduce** and **Stereo -> Mono**) will affect the **entire** sample regardless of its start point or end point.

The **Discard** process deletes the regions before the start point and after the end point.

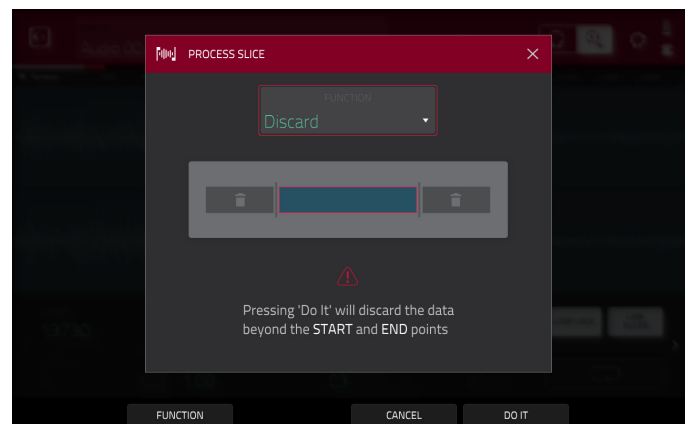

The **Delete** process deletes the region between the start point and end point and closes the gap between them.

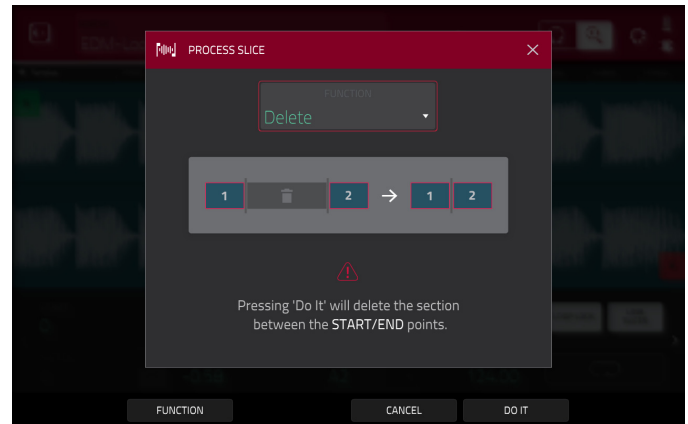

The **Silence** process replaces the region between the start point and end point with silence.

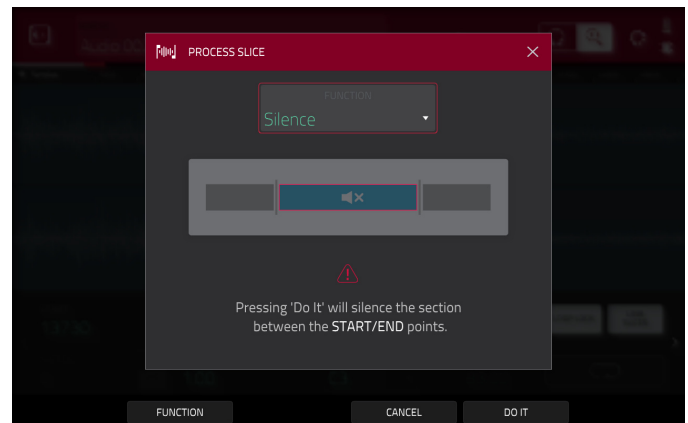

The **Extract** process deletes the regions before the start point and after the end point and saves it as a new sample in your current project.

Use the **Edit Name** field (and the virtual keyboard that appears) to name the new sample.

**Tip:** This is useful if you recorded a drum loop and wanted to remove just a snare drum hit, a kick drum hit, etc. to use separately in the project.

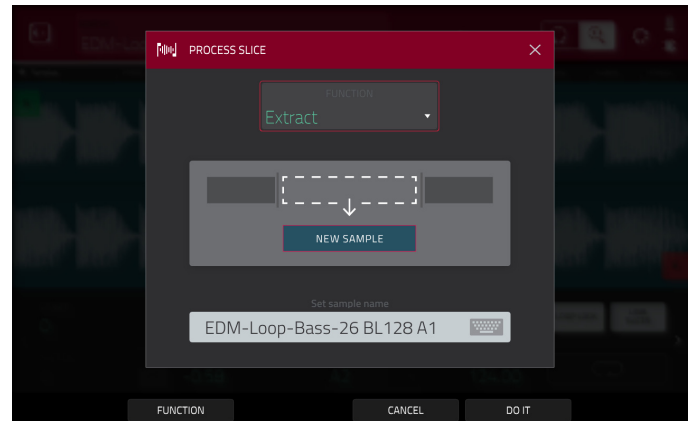

The **Normalize** process increases a sample's level to the highest level possible without distortion. This is essentially a kind of digital gain optimization, so you do not have to worry about excessive level settings when working with samples with a wide range of amplitudes.

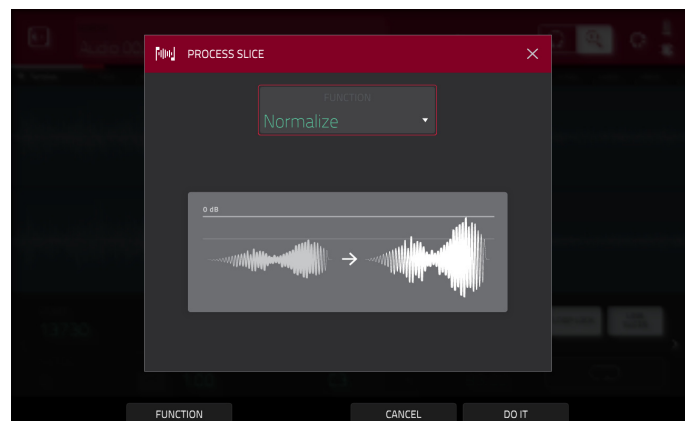

The **Reverse** process reverses the region between the start point and end point.

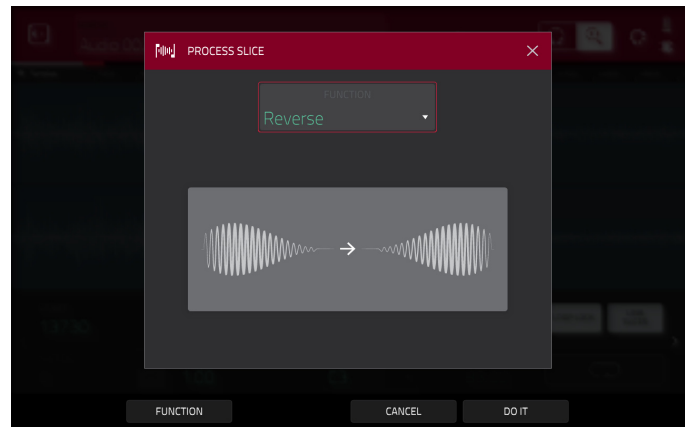

The **Fade In** process sets a fade-in between the start point and end point. The following types are available:

**Linear** fades the audio in with a linear curve—a straight line between the start and end.

**Log** fades the audio in with a logarithmic curve—quickly rising at the start and flattening out towards the end.

**Exp** fades the audio in with an exponential curve—slowly rising in the beginning and growing steeper towards the end.

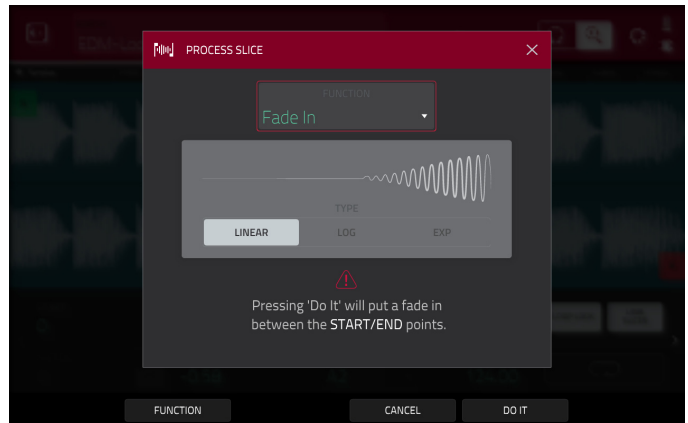

The **Fade Out** process sets a fade-out between the start point and end point. The following types are available:

**Linear** fades the audio out with a linear curve—a straight line between the start and end.

**Log** fades the audio out with a logarithmic curve—quickly rising at the start and flattening out towards the end.

**Exp** fades the audio out with an exponential curve—slowly rising in the beginning and growing steeper towards the end.

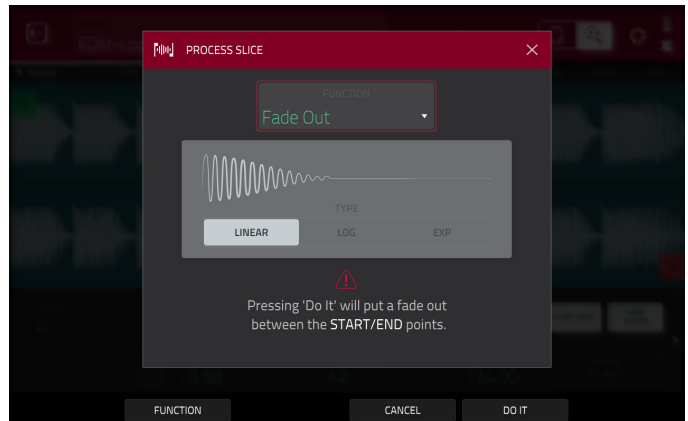

The **Pitch Shift** process changes the pitch of the sample without changing its length. This lets you set the sample's pitch to your sequence without affecting the sample's tempo or duration. You can adjust it up to 12 semitones, up or down. Keep in mind that the audio quality may decrease at more extreme settings.

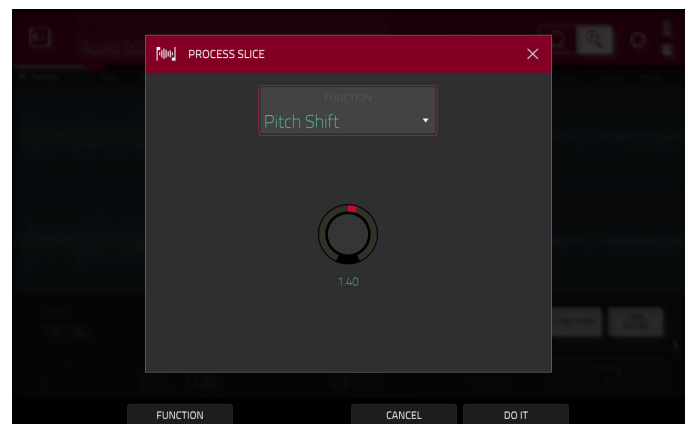



The **Time Stretch** process lengthens or shortens the sample without changing its pitch. This is useful for matching the durations of two samples with different pitches. You can enter the original tempo of the sample and the desired tempo after processing.

Use the **Beat** field to set the desired value number of beats.

Use the **New Tempo** field to set the new tempo. The **Ratio** field will then automatically show the time stretch factor.

Alternatively, to adjust the ratio instead, use the **Ratio** field to set the desired ratio. The **New Tempo** field will then change automatically based on the new time stretch factor.

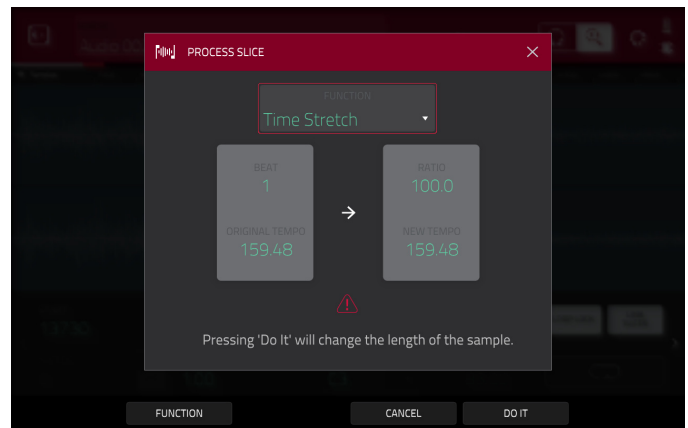

The **Gain Change** process raises or lowers the volume of the sample. You can adjust it up to 18 dB, higher or lower. This function is different than Normalize because it will allow volumes beyond clipping level. This may be a desired effect, but remember to watch your output level!

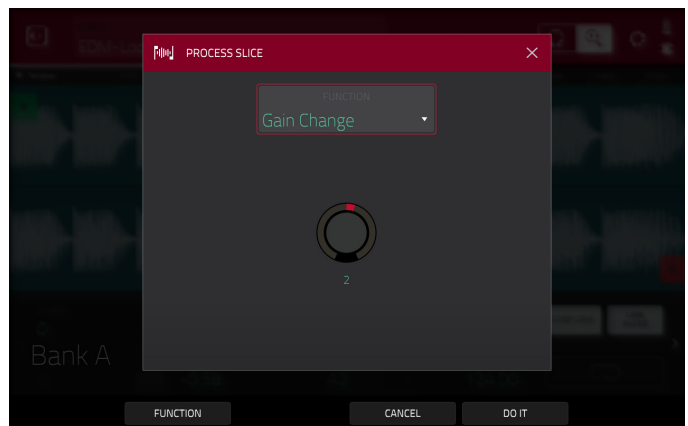

The **Copy** process saves a copy of the sample.

Use the **Edit Name** field (and the virtual keyboard that appears) to name the new sample. Otherwise, the process will add a consecutive number after the sample name.

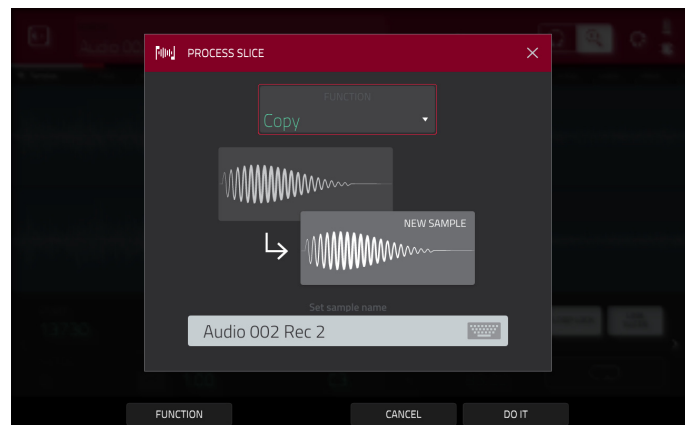

The **Bit Reduce** process lowers the bit resolution of a sample, effectively reducing its degree of faithful reproduction. You can reduce it down to **1 bit**. (The sound is similar to the Resampler effect, but Bit Reduce will permanently alter the sample.)

**Tip:** Use this on drum loops to get a dirty, “old-school” sizzle but with a digital “edge.”

**Note:** This process affects the **entire** sample regardless of its start point or end point.

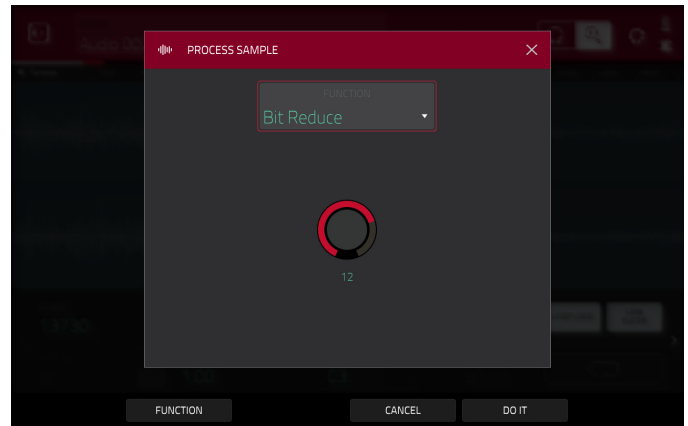

The **Stereo -> Mono** process converts a stereo sample to a new mono sample and saves it as a new sample.

Use the **Edit Name** field (and the virtual keyboard that appears) to name the new sample. Otherwise, the process will add a consecutive number after the sample name.

The following options are available:

- **Left** will convert the left channel only.
- **Right** will convert the right channel only.
- **Sum** will combine the left and right audio channels to a single mono channel.

**Note:** This process affects the **entire** sample regardless of its start point or end point.

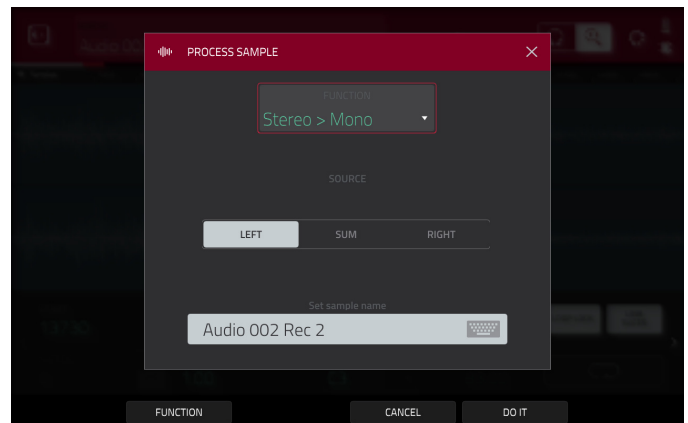

The **Create Stems** process isolates different parts of the sample and separates them into new stem samples.

Click the icons to select or deselect from the following elements to create stems of:

- **Vocals:** Isolate vocal elements of the track into a stem.
- **Bass:** Isolate bass elements of the track into a stem.
- **Drums:** Isolate percussive elements of the track into a stem.
- **Other:** Isolate other musical textures, such as keys or guitars, into a stem.

Use the **Program** dropdown menu to select the program where the stems will be added.

The **Assign to Pad** function determines where the stem separated samples are added. When checked, you can select a pad in the chosen Program using the dropdown menu, and the stems will be added to the four layers of that pad. When unchecked, the stems will be added to the general project sample pool in the **Project Info** Browser.

Click the **Use trimmed sample** box to trim the source sample between the **Start** and **End** points before applying the stem separation process.

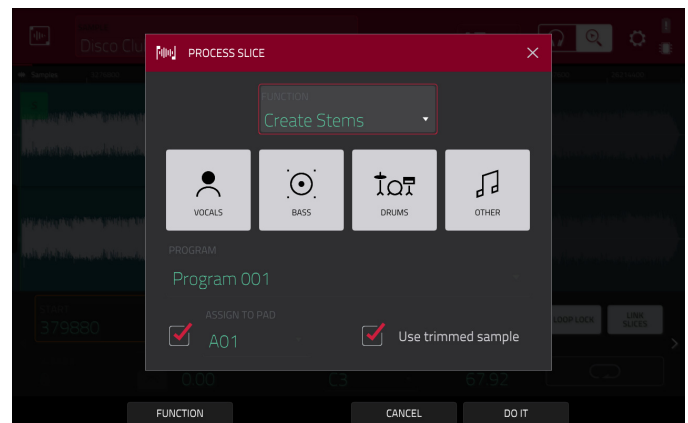

## Chop Mode

Whereas Trim Mode crops only the start and/or end off of a sample, Chop Mode divides the sample into multiple regions called **slices**. We recommend using Chop Mode when working with a long sample with different sounds throughout (e.g., a drum loop or a long melodic or harmonic passage).

To enter Chop Mode, tap the **Trim/Chop** button in the lower-left corner so it says **Chop**.

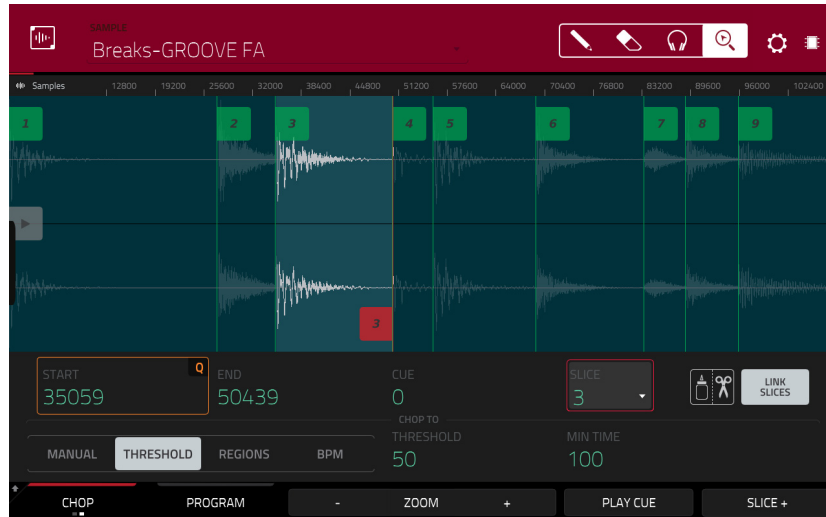

Use the **Start** and **End** fields to set the position of the start point and end point (respectively) of the currently selected slice. Alternatively, tap and drag the start (**S**) or end (**E**) marker left or right, or use the **first** column of **Q-Link knobs (Start X1\_\_)** to adjust the start point or the **second** column of **Q-Link knobs (End X1\_\_)** to adjust the end point.

Use the selector in the lower-left corner of the screen to choose how you want to use Chop Mode:

### Manual

This method lets you insert slices at locations you select.

### Threshold

This method uses an adjustable detection algorithm that derives the number of slices created from the volume levels present in the sample.

Use the **Threshold** field to set the threshold level. Alternatively, turn **Q-Link Knob 11 (Threshold on MPC X)** or the **second Q-Link knob** in the **third column** (MPC Live/Live II/One/Key 61/Key 37/Touch). The higher the selected value, the more slices will be created.

Use the **Min Time** field to set the minimum length of a slice in milliseconds.

### Regions

This method divides a sample into several slices of equal length.

Use the **Regions** field to set how many regions the sample will be divided into. Alternatively, turn **Q-Link Knob 11 (Num Regions on MPC X)** or the **second Q-Link knob** in the **third column** (MPC Live/Live II/One/Key 61/Key 37/Touch). The higher the selected value, the more slices will be created.

### BPM

This method divides a sample into several slices based on the tempo (beats per minute).

Use the **Bars** field to set how many bars are in the sample. Alternatively, turn **Q-Link Knob 11 (Bars on MPC X)** or the **second Q-Link knob** in the **third column** (MPC Live/Live II/One/Key 61/Key 37/Touch).

Use the **Beats** field to set how many beats are in each bar. Alternatively, turn **Q-Link Knob 7 (Beats on MPC X)** or the **third Q-Link knob** in the **third column** (MPC Live/Live II/One/Key 61/Key 37/Touch).

Use the **Time Div** field to set a note division. Alternatively, turn **Q-Link Knob 3 (Time Div on MPC X)** or the **fourth Q-Link knob** in the **third column** (MPC Live/Live II/One/Key 61/Key 37/Touch). The slice markers will be placed according to this setting. You can select **1/4**, **1/8**, **1/16**, or **1/32**. (In most cases, you should set this parameter to **1/16**.)

To play a slice, do either of the following:

- Press the **pad** that corresponds to the slice. If your sample has more than 16 slices, use the additional pad banks.
- When the **headphones icon** (in the upper-right corner) is selected, tap a **slice** in the waveform.

When the **One Shot** feature is enabled, you can press a pad once to play the entire slice. When this is disabled, pressing the pad and holding it will play the slice; releasing it will stop playback.

To enable or disable **One Shot**, press and hold **Shift**, and then tap **One Shot**.

To select a slice to edit, do any of the following:

- Use the **Slice** field.
- Turn **Q-Link Knob 16 (Select Slice)** on MPC X) or the **first Q-Link knob** in the **fourth column** (MPC Live/Live II/One/Key 61/Key 37/Touch).
- When the **headphones icon** (in the upper-right corner) is selected, tap a **slice** in the waveform.

To add a slice at the current playhead position, tap **Slice+** at the bottom of the screen. You can do this at any point during sample playback.

To insert a slice marker during sample playback, press an **unlit pad** (usually **Pad 1**) to start playback of the sample, and then press an **unlit pad** during playback to place a slice marker at each location of the playhead. (If you press a lit pad, playback will restart from that pad's corresponding slice marker.) The number of the pad that is lit **green** is the number of the most-recently inserted slice marker. The numbers of the pads that are lit **yellow** are the numbers of the slice markers that are already inserted.

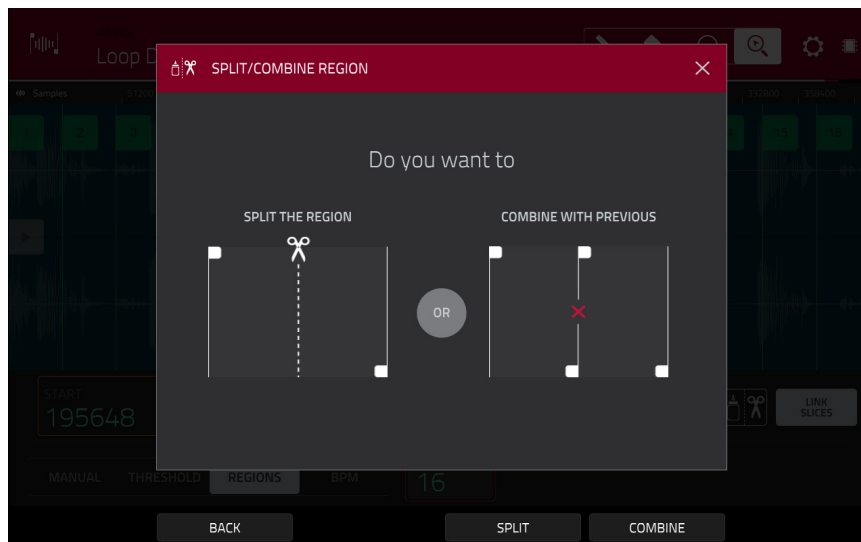

To split or combine slices, tap the **glue-and-scissors icon**. In the **Split/Combine Region** screen that appears, tap one of the following buttons:

- Split:** This splits the currently selected region into two equal slices.
- Combine:** This combines the currently selected region with the one before it.
- Back:** This closes the window.

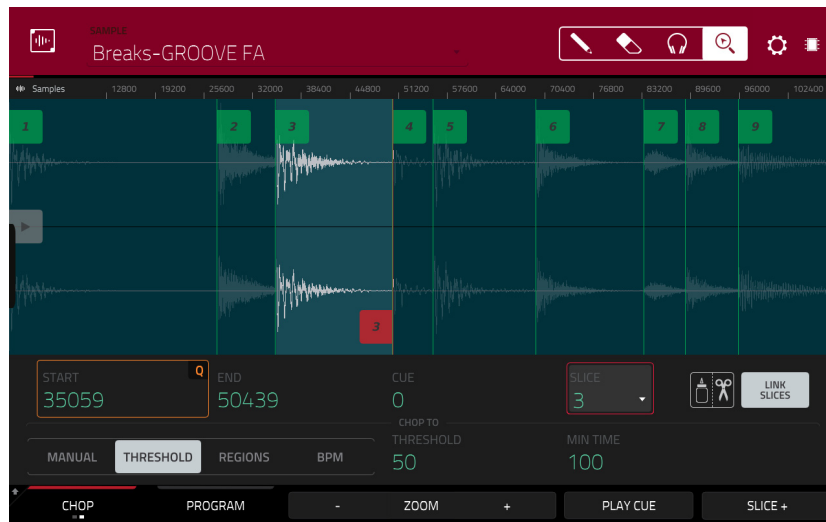

When **Link Slices** is enabled, changing the start point of a slice will also change the end point of the previous slice. Similarly, changing the end point of a slice will also change the start point of the next slice. Disable **Link Slices** if you are trying to create slices that use non-contiguous parts of the sample.

**To enable or disable this feature**, tap the **Link Slices** button.

**Important:** **Link Slices** must be disabled to make slices nonsequential, noncontiguous, or overlapping.

**To remove all slices from a sample**, press and hold **Shift** and tap **Clear All**.

The cue playhead is useful when manually inserting slice markers. You can set its position and behavior to suit your workflow.

Use the **Cue** field to adjust the position of the cue playhead. Alternatively, tap and drag the translucent marker with the triangle (▶).

**To play the sample from the cue playhead**, tap **Play Cue** at the bottom of the screen.

**To create a slice marker at the cue playhead position**, tap **Slice+** at the bottom of the screen.

**To set how the cue playhead behaves**, use the **Settings** window (described [earlier](#)).

**0 Snap** forces start points and end points to occur only at the waveform's "zero-crossings." This can help to avoid clicks and glitches when playing a sample.

**To enable or disable 0 Snap**, press and hold **Shift**, and then tap **0 Snap** at the bottom of the screen.

## Converting or Assigning Slices

You can assign your new sample directly to a pad from Chop Mode. You can also convert it into a new program or patched phrase.

**To convert or assign a sample**, press and hold **Shift**, and then tap **Convert** at the bottom of the screen to open the Convert or Assign Slices window.

If you set the **Convert To** field to **New [program type] program using slices**, this will create a new program and assign the sample's slices to its pads. The pads will simply refer to the slices in this sample instead of creating new samples. This is useful for reducing clutter in your project. The new program will be named after the sample and appended with **ch**.

Use the **Slice Type** field to select how each pad's layer settings will be set when the slices are assigned to them (see [Program Edit Mode](#) to learn more about the parameters mentioned below):

- **Non-Destructive Slice:** Each pad's **Slice** setting will be set to the slice number.
- **Pad Parameters:** Each pad's **Slice** setting will be set to **Pad**. The **Pad Start** and **Pad End** parameters will be set to the slice's start point and end point values, and the **Loop Pos** parameter will be set to the slice's start point but with **Pad Loop** deactivated.

Check the **Create Events** box to automatically create a new track for the new program in which each pad plays its corresponding slice in ascending sequence by pad number.

If **Create Events** is checked, use the **Bars** field to set how many bars the slices' events will occupy.

**To convert the sample**, tap **Do It**.

**To cancel the operation**, tap **Close**.

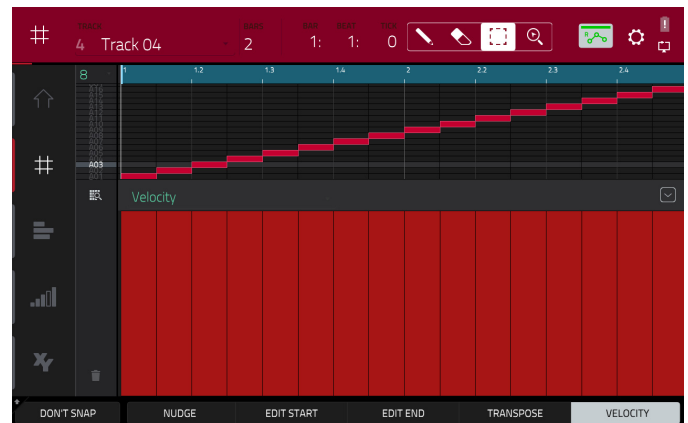
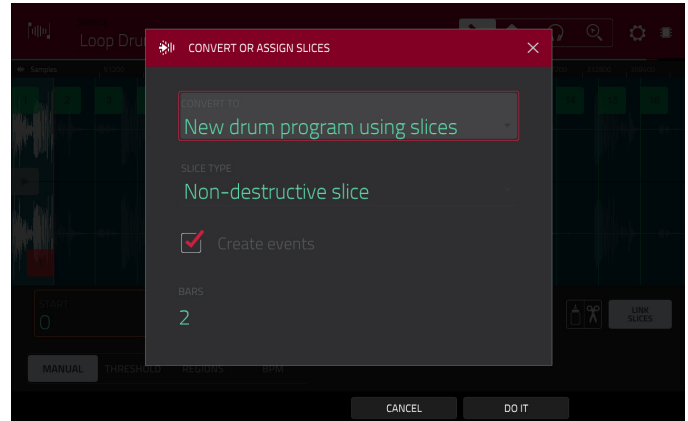

If you set the **Convert To** field to **New clip program**, this will create a new clip program and assign the sample's slices to its pads as clips. The pads will simply refer to the slices in this sample instead of creating new samples. This is useful for reducing clutter in your project. The new program will be named after the sample and appended with **ch**.

Use the **Tempo** field to enter the tempo of the clips in the new program.

Check the **Create Events** box to automatically create a new track for the new program in which each pad plays its corresponding slice in ascending sequence by pad number.

If **Create Events** is checked, use the **Bars** field to set how many bars the slices' events will occupy.

**To convert the sample, tap Do It.**

**To cancel the operation, tap Close.**

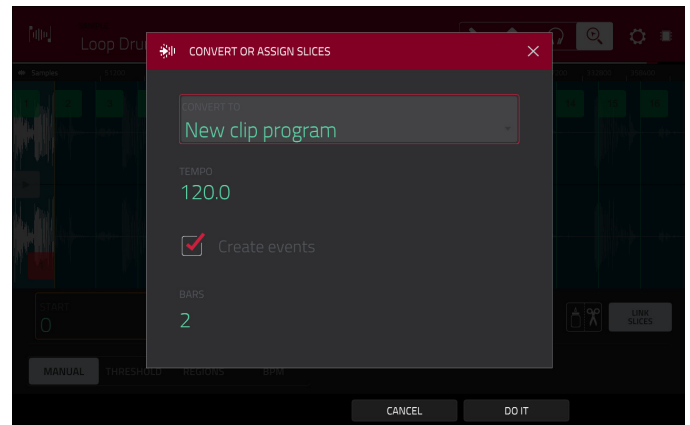

If you set the **Convert To** field to **New program with new samples**, this will create a new sample from each slice and assign them to pads in a new program.

The new program will be named after the sample and appended with **ch**. The new samples will be appended with **SI-#** (where # is a consecutive number).

Check the **Crop Samples** box to delete the unused parts from the sample when they are created and assigned. This feature is destructive, though the project will still contain your original sample.

Leave this box unchecked to keep the unused parts of the samples when they're created and assigned. This way, you will still be able to edit the entire samples further even though you are using only part of them at the moment.

By default, this option already will create a new program. You can **uncheck** the **Create New Program** box to convert each slice into a sample that is placed in the project's sample pool but not assigned to a program or pad.

If **Create New Program** is checked, check the **Create Events** box to automatically create a new track in which each pad plays its corresponding slice in ascending sequence by pad number.

If **Create Events** is checked, use the **Bars** field to set how many bars the slices' events will occupy.

**To convert the sample, tap Do It.**

**To cancel the operation, tap Close.**

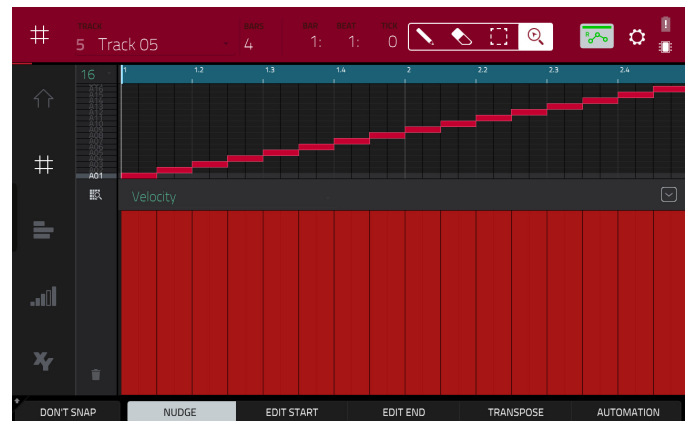
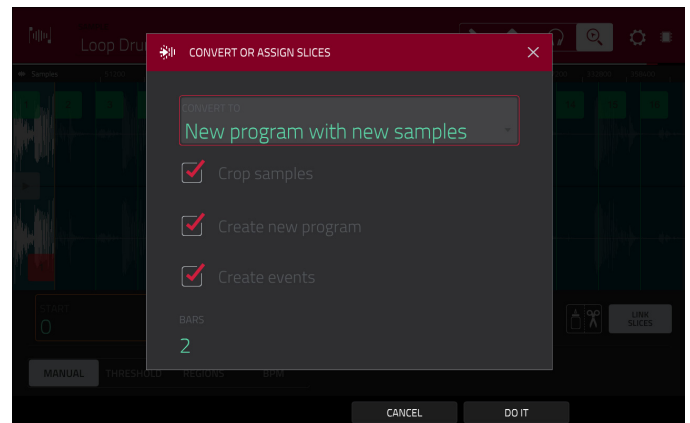

If you set the **Convert To** field to **Assign slice to a pad**, the pad will simply refer to the slice in this sample instead of creating a new sample. This is useful for reducing clutter in your project.

**Important:** Assigning a sample to a pad in this way will replace the sample on the first layer of the pad.

Use the **Pad** field to select the desired pad. Alternatively, press the desired pad.

Use the **Slice Type** field to select how the pad's layer settings will be set when the slice is assigned to it (see [Program Edit Mode](#) to learn more about the parameters mentioned below):

- **Non-Destructive Slice:** The pad's **Slice** setting will be set to the slice number.
- **Pad Parameters:** The pad's **Slice** setting will be set to **Pad**. The **Pad Start** and **Pad End** will be set to the slice's start point and end point values, and the **Loop Position** will be set to the slice's start point but with **Pad Loop** deactivated.

Use the **Program** field to specify the program to which you want to add the slice.

**To convert the sample**, tap **Do It**.

**To cancel the operation**, tap **Close**.

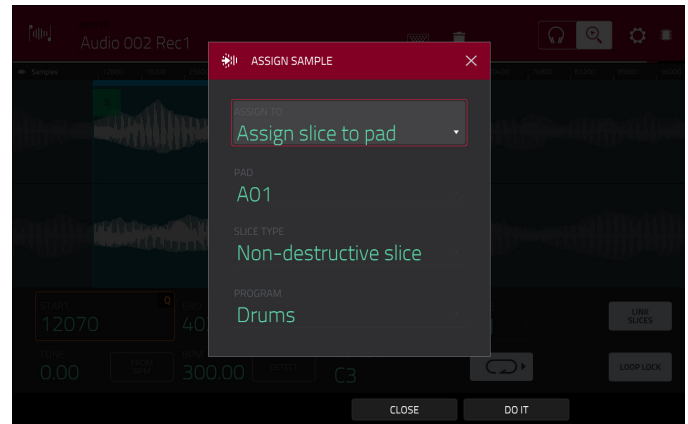

If you set the **Convert To** field to **Make new sample**, this will create a new sample in your project. (The original sample will remain as it is.)

**Important:** Assigning a sample to a pad in this way will replace the sample on the first layer of the pad.

Use the **Pad** field to select the desired pad. Alternatively, press the desired pad.

Check the **Crop Sample** box to delete the unused parts from the sample when it's created and assigned. This feature is destructive, though the project will still contain your original sample.

Leave this box unchecked to keep the unused parts of the sample when it is created and assigned. This way, you will still be able to edit the entire sample further even though you are using only part of it at the moment.

Use the **Program** field to specify the program to which you want to add the slice.

**To convert the sample**, tap **Do It**.

**To cancel the operation**, tap **Close**.

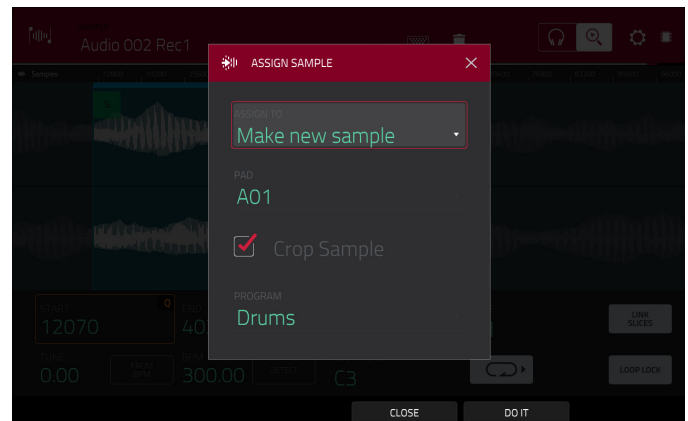



If you set the **Convert To** field to **Patched phrase**, this will create a new sample that will play based on the tempo of your Sequence, and places it in the current project. The patched phrase will have the same name as the original sample but appended with **pp** and will use a different icon when viewing your project information.

Use the **Bars** field to set how many bars long the patched phrase is meant to be.

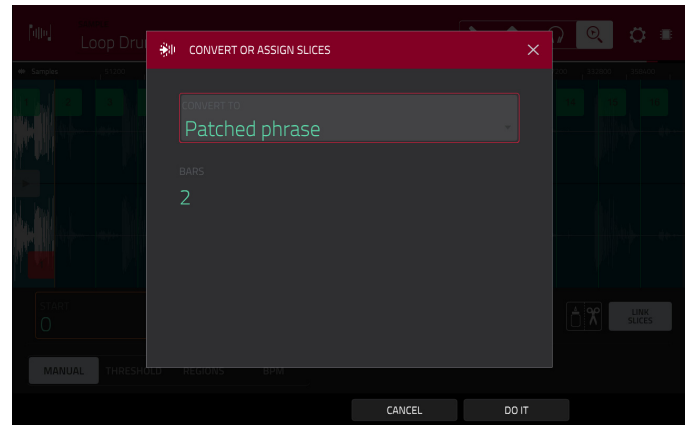

## Processing Slices

Press and hold **Shift**, and then tap the **Process** button to open the Process window, where you can select an editing option for the currently selected slice. (This has fewer options than Trim Mode. Unavailable ones are darkened.)

Use the **Function** field to select an editing process. Double-tap it or tap **Function** at the bottom of the screen to open the Function window, which displays an overview of all available editing processes.

**Important:** Chop Mode is non-destructive: You can choose the slice/edit behavior without destroying your original sample, giving you more control over sample playback; you can save your sliced sample and but also reuse all of the slice data in another project. See the [Program Edit Mode](#) chapter to learn more about setting a pad to play the entire sample, a specific slice of a sample, or a specific region of the sample (independent of its slice markers).

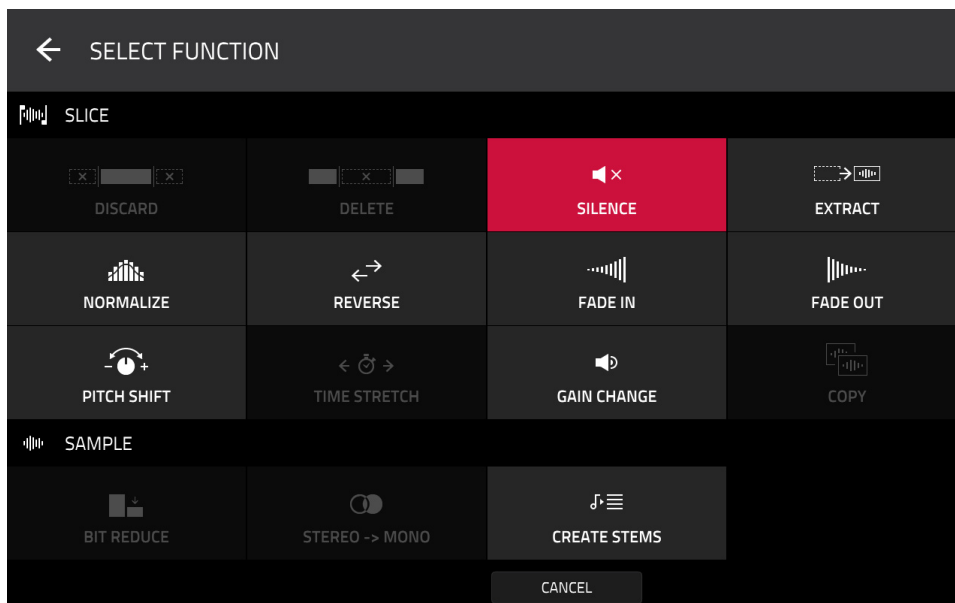

You can use any of these functions as described below.

**To return to Sample Edit Mode**, tap **Cancel**.

**To return to the Process window**, tap the top of the screen.

**Note:** All processes here will affect only the currently selected slice.

The **Silence** process replaces the region between the start point and end point with silence.

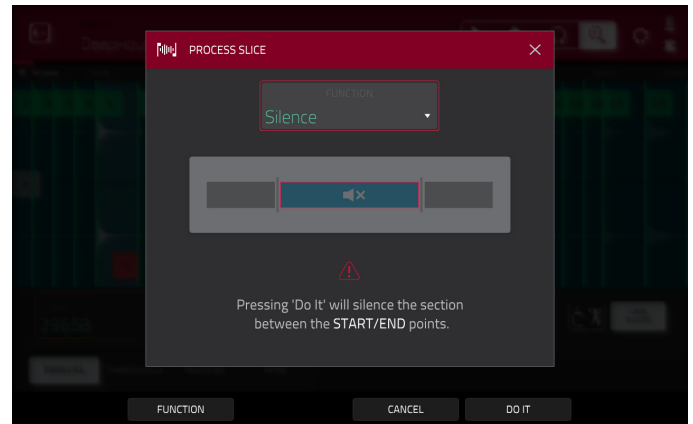

The **Extract** process deletes the regions before the start point and after the end point and saves it as a new sample (with a name you enter) in your current project.

**Tip:** This is useful if you recorded a drum loop and wanted to remove just a snare drum hit, a kick drum hit, etc. to use separately in the project.

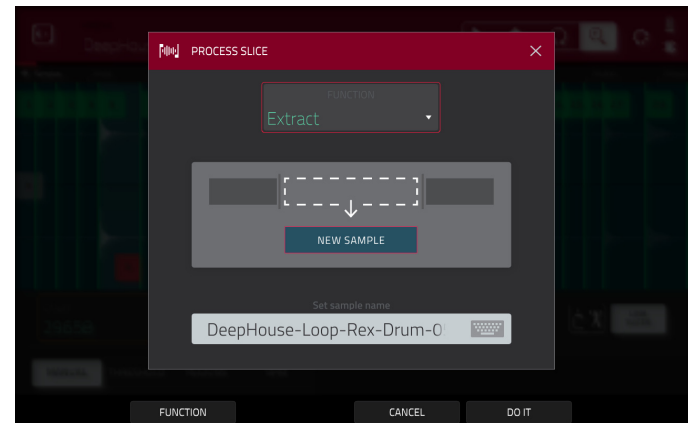

The **Normalize** process increases a sample's level to the highest level possible without distortion. This is essentially a kind of digital gain optimization, so you do not have to worry about excessive level settings when working with samples with a wide range of amplitudes.

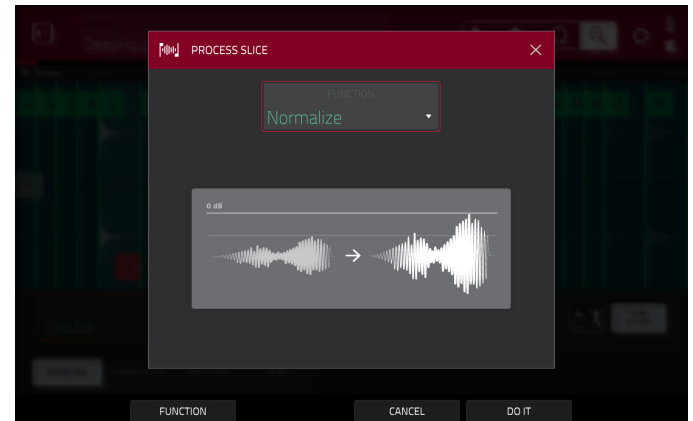

The **Reverse** process reverses the region between the start point and end point.

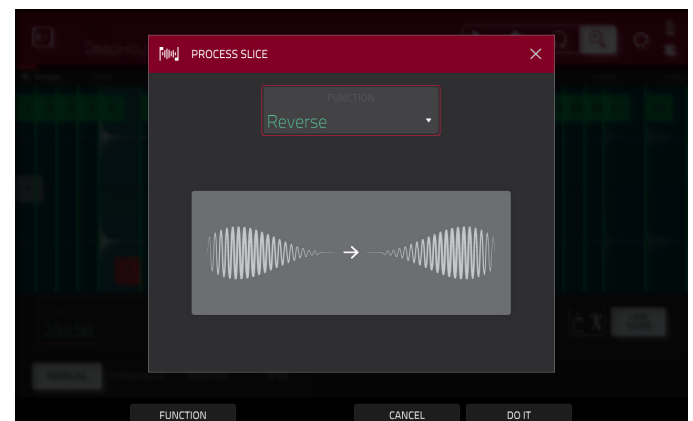

The **Fade In** process sets a fade-in between the start point and end point. The following types are available:

**Linear** fades the audio in with a linear curve—a straight line between the start and end.

**Log** fades the audio in with a logarithmic curve—quickly rising at the start and flattening out towards the end.

**Exp** fades the audio in with an exponential curve—slowly rising in the beginning and growing steeper towards the end.

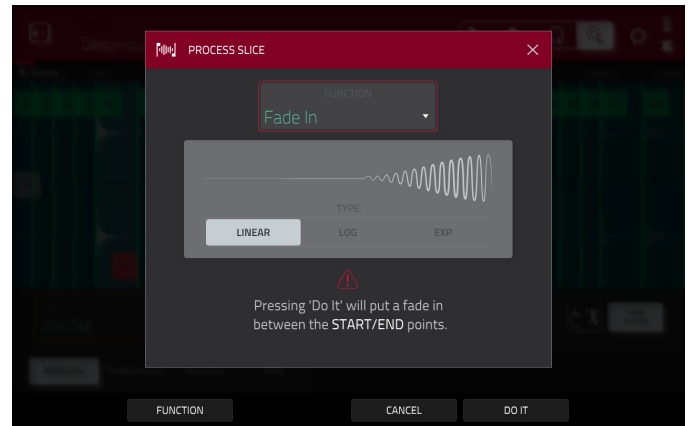

The **Fade Out** process sets a fade-out between the start point and end point. The following types are available:

**Linear** fades the audio out with a linear curve—a straight line between the start and end.

**Log** fades the audio out with a logarithmic curve—quickly rising at the start and flattening out towards the end.

**Exp** fades the audio out with an exponential curve—slowly rising in the beginning and growing steeper towards the end.

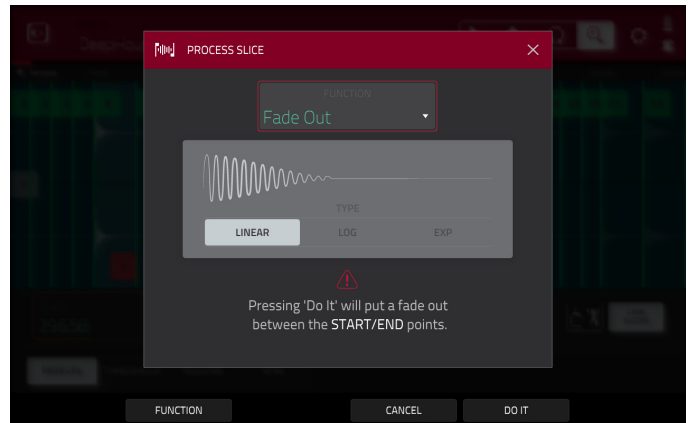

The **Pitch Shift** process changes the pitch of the sample without changing its length. This lets you set the sample's pitch to your sequence without affecting the sample's tempo or duration. You can adjust it up to 12 semitones, up or down. Keep in mind that the audio quality may decrease at more extreme settings.

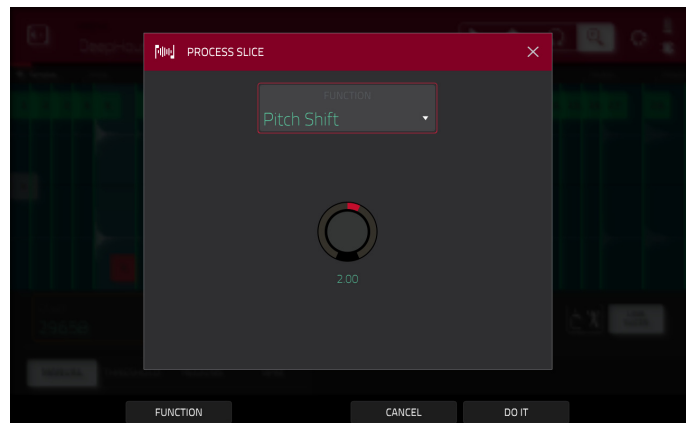

The **Gain Change** process raises or lowers the volume of the sample. You can adjust it up to 18 dB, higher or lower. This function is different than Normalize because it will allow volumes beyond clipping level. This may be a desired effect, but remember to watch your output level!

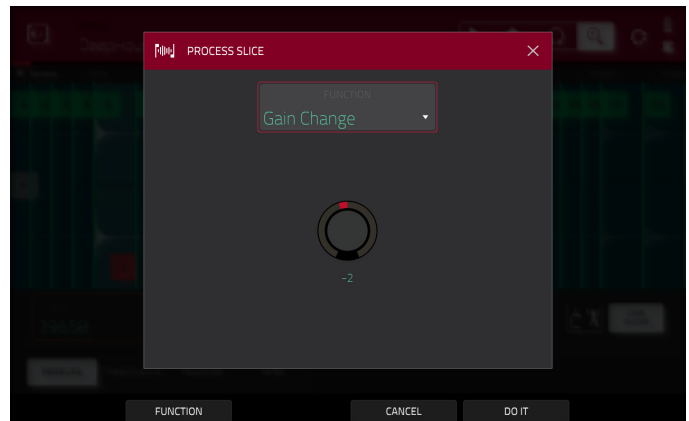

The **Create Stems** process isolates different parts of the sample and separates them into new stem samples.

Click the icons to select or deselect from the following elements to create stems of:

- **Vocals:** Isolate vocal elements of the track into a stem.
- **Bass:** Isolate bass elements of the track into a stem.
- **Drums:** Isolate percussive elements of the track into a stem.
- **Other:** Isolate other musical textures, such as keys or guitars, into a stem.

Use the **Program** dropdown menu to select the program where the stems will be added.

The **Assign to Pad** function determines where the stem separated samples are added. When checked, you can select a pad in the chosen Program using the dropdown menu, and the stems will be added to the four layers of that pad. When unchecked, the stems will be added to the general project sample pool in the **Project Info Browser**.

Click the **Use trimmed sample** box to trim the source sample between the **Start** and **End** points before applying the stem separation process.

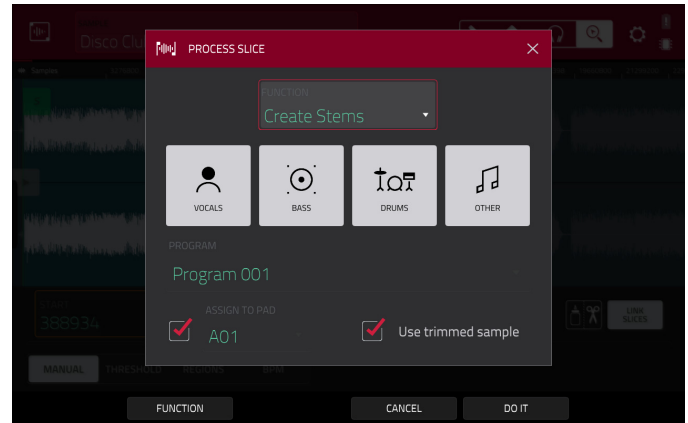

## Program Mode

Program Mode lets you edit a sample in the context of the program in which you'll use it. You can adjust the pad parameters as though you were in Program Edit Mode, auditioning and hearing how it will sound in the program's audio path.

**To enter Program Mode**, tap the **Program** button at the bottom of the screen. The pads will show their assigned samples in the current Program.



Use the **Start** and **End** fields to set the position of the start point and end point of the sample (respectively). Alternatively, tap and drag the start (**S**) or end (**E**) marker left or right, or use the **first** column of **Q-Link knobs (Start X1\_\_)** to adjust the start point or the **second** column of **Q-Link knobs (End X1\_\_)** to adjust the end point.

Program Mode includes a loop function. When on, the region of the sample between the loop point and end point will repeat. This is useful when trying to find an ideal spot to begin the sample. The loop cannot be earlier than the start point.

**To adjust the loop point**, do any of the following:

- Use the **Loop** field.
- Tap and drag the start (**S**) marker (if **Loop Lock** is on) or the **loop** marker (if **Loop Lock** is off).
- Use the **first** column of **Q-Link knobs (Start X1\_\_)**; if **Loop Lock** is on) or the **third** column of **Q-Link knobs (Loop X1\_\_)**; if **Loop Lock** is off). The top-most **Q-Link knobs (13 and 15)** provide coarse adjustment. The bottom-most **Q-Link knobs (1 and 3)** provide fine adjustment.

**To turn Loop Lock on or off**, tap the **Loop Lock** button. When on, the loop point is the same as the start point. When off, the loop point is independent from the start point.

**To turn the loop function on or off**, tap the **Loop** button to cycle between the four modes:

**Off:** The sample will not loop.

**Forward:** When the loop reaches its end point, it will start playing again from the loop point.

**Reverse:** When the loop reaches its end point, it will play in reverse. When it reaches the loop point again, it will return to the end point and continue playing in reverse.

**Alternating:** When the loop reaches its end point, it will play in reverse. When it reaches the loop point again, it will start playing forward again from the loop point.

**To switch between Forward and off**, press and hold **Shift**, and then tap **Loop** at the bottom of the screen.

Tap each **pad** to hear its sample/samples. The sample on its first layer will automatically appear in the waveform display for editing.

Use the **Tune** field to transpose the sample up or down from its original pitch.

Tap **From BPM** to open the **Edit Tuning** window, which lets you tune a sample to the current sequence.

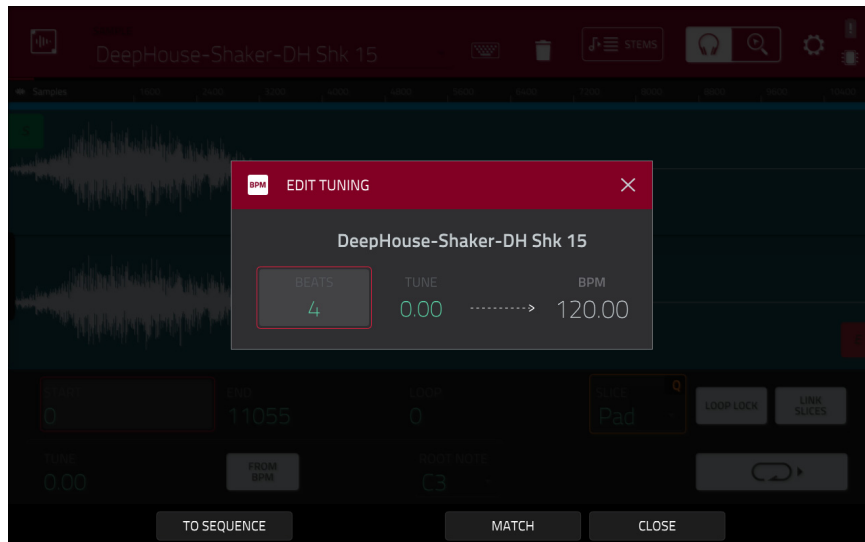

Use the **Number of Beats** field to match the number of beats in the sequence.

**To tune the sample to the sequence**, tap **Match**. The **Tune** field will adjust automatically and close the window. The sample is now tuned to the sequence.

**To tune the sample to the sequence and adjust the sequence tempo**, tap **To Seq**. This is the same as tapping Match but it also changes the sequence's tempo to the BPM shown in the **Tempo** field on the right.

**To close the window**, tap **Close**.

Use the **Root Note** field to set the root note of the sample. This defines which note will play the sample at its original pitch when in a keygroup program.

Use the **Slice** field to display either the sample as it has been edited (**Pad**) or the entire sample (**All**).

If the **Slice** field is set to **All**, you can display the sample as it has been edited but keep the start point and end point. **To do this**, press and hold **Shift**, and then tap **To Pad** at the bottom of the screen. The **Slice** field will change to **Pad**, but the start point and end point will remain in their current locations.

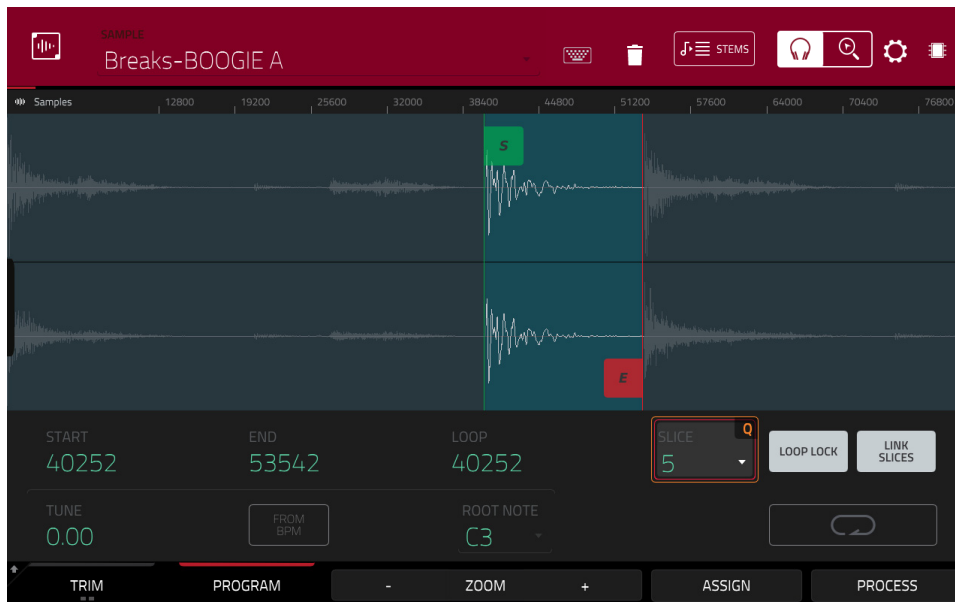

The **Link Slices** button does not have a function in Program Mode.

**0 Snap** forces start points, end points, and loop points to occur only at the waveform's “zero-crossings.” This can help to avoid clicks and glitches when playing a sample.

To enable or disable **0 Snap**, press and hold **Shift**, and then tap **0 Snap** at the bottom of the screen.

To enable or disable the loop function, press and hold **Shift**, and then tap **Loop** at the bottom of the screen. This switches the loop function between **Forward** and **off**. The loop function is described [earlier](#).

## Assigning Samples

You can assign your new sample directly to a pad from Program Mode.

**To assign a sample**, tap **Assign** at the bottom of the screen to open the Assign Sample window.

**Important:** Assigning a sample to a pad in this way will replace the sample on the first layer of the pad.

If you set the **Assign To** field to **Assign slice to a pad**, the pad will simply refer to the slice in this sample instead of creating a new sample. This is useful for reducing clutter in your project.

Use the **Pad** field to select the desired pad. Alternatively, press the desired pad.

Use the **Slice Type** field to select how the pad's layer settings will be set when the slice is assigned to it (see [Program Edit Mode](#) to learn more about the parameters mentioned below):

- **Non-Destructive Slice:** The pad's **Slice** setting will be set to the slice number.
- **Pad Parameters:** The pad's **Slice** setting will be set to **Pad**. The **Pad Start** and **Pad End** will be set to the slice's start point and end point values, and the **Loop Position** will be set to the slice's start point but with **Pad Loop** deactivated.

Use the **Program** field to specify the program to which you want to add the slice.

**To assign the sample**, tap **Do It**.

**To cancel the operation**, tap **Close**.

If you set the **Assign To** field to **Make new sample**, this will create a new sample in your project. (The original sample will remain as it is.)

Use the **Pad** field to select the desired pad. Alternatively, press the desired pad.

Check the **Crop Sample** box to delete the unused parts from the sample when it's created and assigned. This feature is destructive, though the project will still contain your original sample.

Leave this box unchecked to keep the unused parts of the sample when it is created and assigned. This way, you will still be able to edit the entire sample further even though you are using only part of it at the moment.

Use the **Program** field to specify the program to which you want to add the slice.

**To assign the sample**, tap **Do It**.

**To cancel the operation**, tap **Close**.

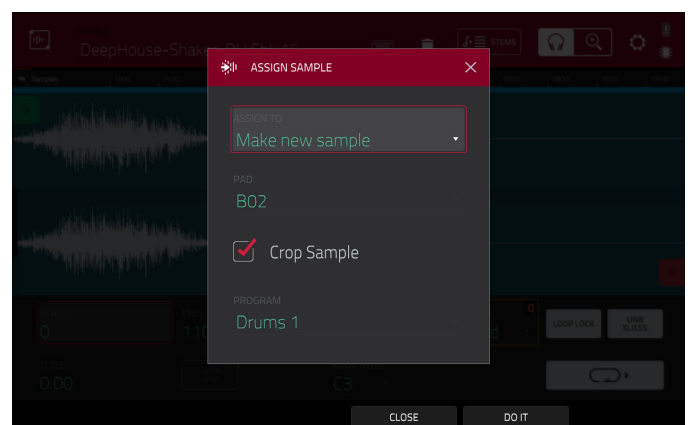
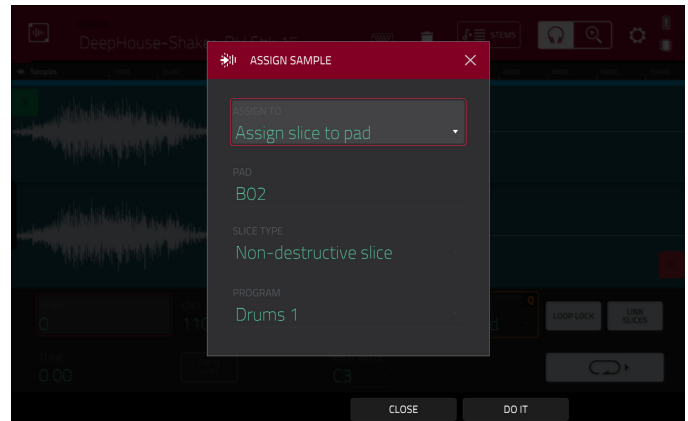



## Processing Slices

Press and hold **Shift**, and then tap the **Process** button to open the Process window, where you can select an editing option for the currently selected slice. (This has fewer options than Trim Mode. Unavailable ones are darkened.)

Use the **Function** field to select an editing process. Double-tap it or tap **Function** at the bottom of the screen to open the Function window, which displays an overview of all available editing processes.

**Important:** Program Mode is non-destructive: You can choose the slice/edit behavior without destroying your original sample, giving you more control over sample playback; you can save your sliced sample and but also reuse all of the slice data in another project. See the [Program Edit Mode](#) chapter to learn more about setting a pad to play the entire sample, a specific slice of a sample, or a specific region of the sample (independent of its slice markers).

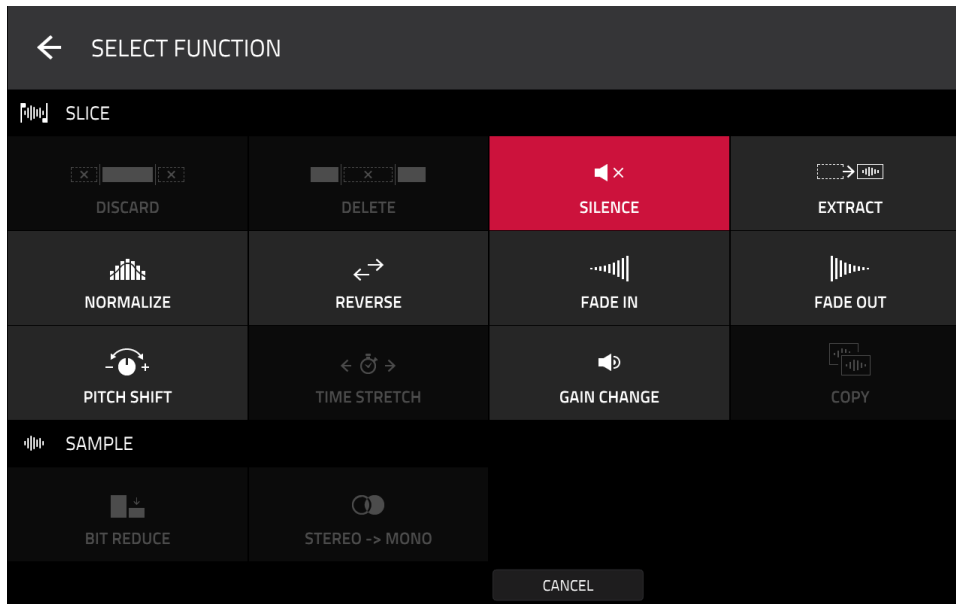

You can use any of these functions as described below.

**To return to Sample Edit Mode,** tap **Cancel**.

**To return to the Process window,** tap the top of the screen.

**Note:** All processes here will affect only the currently selected slice.

The **Silence** process replaces the region between the start point and end point with silence.

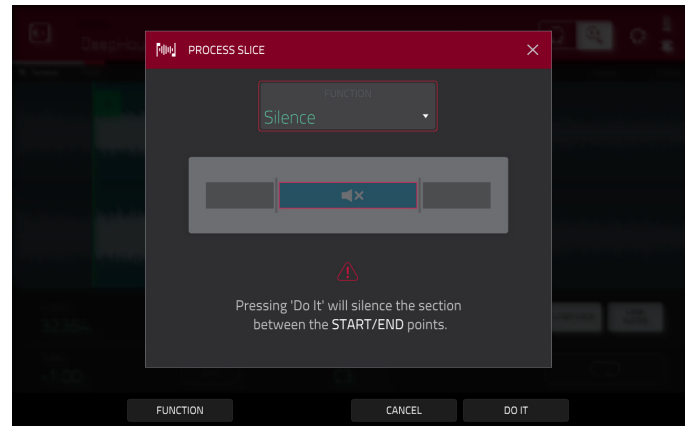

The **Extract** process deletes the regions before the start point and after the end point and saves it as a new sample (with a name you enter) in your current project.

**Tip:** This is useful if you recorded a drum loop and wanted to remove just a snare drum hit, a kick drum hit, etc. to use separately in the project.

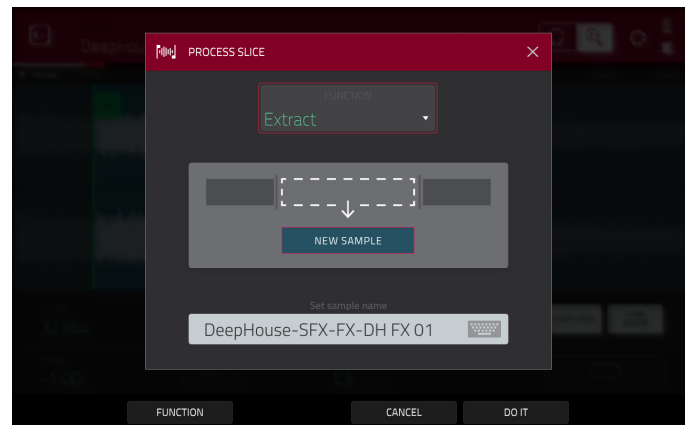

The **Normalize** process increases a sample's level to the highest level possible without distortion. This is essentially a kind of digital gain optimization, so you do not have to worry about excessive level settings when working with samples with a wide range of amplitudes.

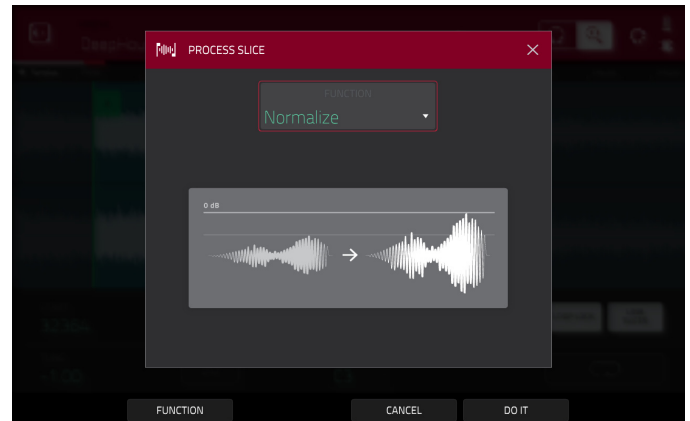

The **Reverse** process reverses the region between the start point and end point.

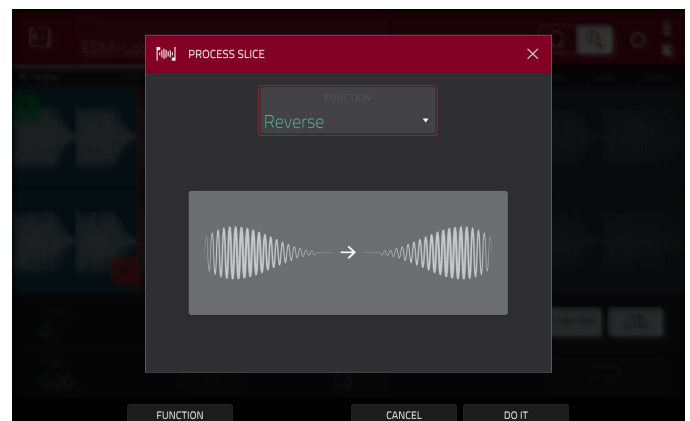

The **Fade In** process sets a fade-in between the start point and end point. The following types are available:

**Linear** fades the audio in with a linear curve—a straight line between the start and end.

**Log** fades the audio in with a logarithmic curve—quickly rising at the start and flattening out towards the end.

**Exp** fades the audio in with an exponential curve—slowly rising in the beginning and growing steeper towards the end.

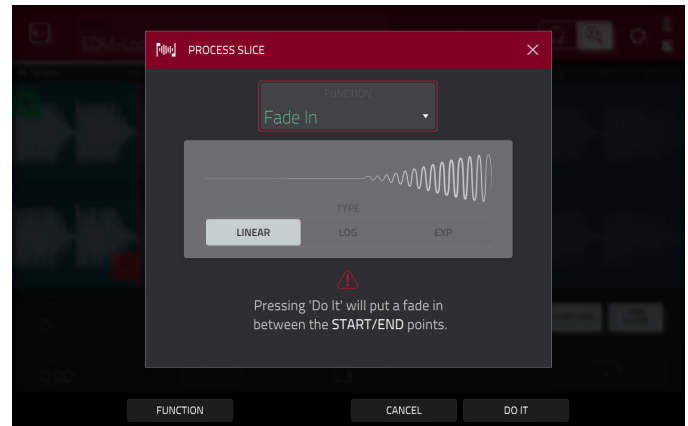

The **Fade Out** process sets a fade-out between the start point and end point. The following types are available:

**Linear** fades the audio out with a linear curve—a straight line between the start and end.

**Log** fades the audio out with a logarithmic curve—quickly rising at the start and flattening out towards the end.

**Exp** fades the audio out with an exponential curve—slowly rising in the beginning and growing steeper towards the end.

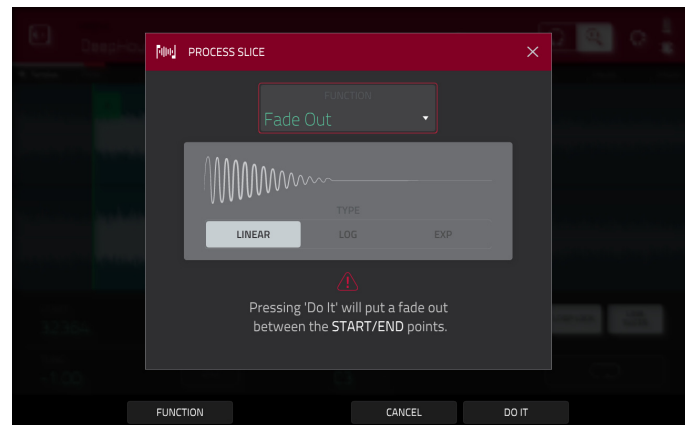

The **Pitch Shift** process changes the pitch of the sample without changing its length. This lets you set the sample's pitch to your sequence without affecting the sample's tempo or duration. You can adjust it up to 12 semitones, up or down. Keep in mind that the audio quality may decrease at more extreme settings.

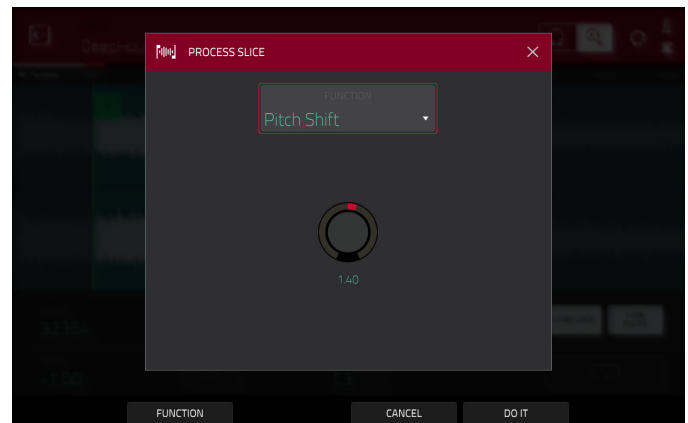

The **Gain Change** process raises or lowers the volume of the sample. You can adjust it up to 18 dB, higher or lower. This function is different than Normalize because it will allow volumes beyond clipping level. This may be a desired effect, but remember to watch your output level!

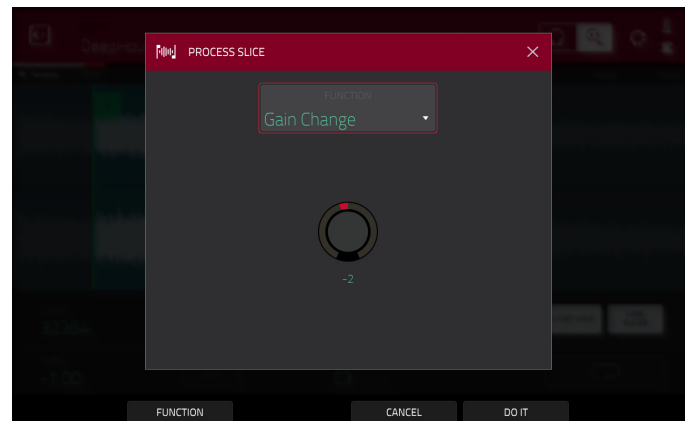

The **Create Stems** process isolates different parts of the sample and separates them into new stem samples.

Click the icons to select or deselect from the following elements to create stems of:

- **Vocals:** Isolate vocal elements of the track into a stem.
- **Bass:** Isolate bass elements of the track into a stem.
- **Drums:** Isolate percussive elements of the track into a stem.
- **Other:** Isolate other musical textures, such as keys or guitars, into a stem.

Use the **Program** dropdown menu to select the program where the stems will be added.

The **Assign to Pad** function determines where the stem separated samples are added. When checked, you can select a pad in the chosen Program using the dropdown menu, and the stems will be added to the four layers of that pad. When unchecked, the stems will be added to the general project sample pool in the **Project Info Browser**.

Click the **Use trimmed sample** box to trim the source sample between the **Start** and **End** points before applying the stem separation process.

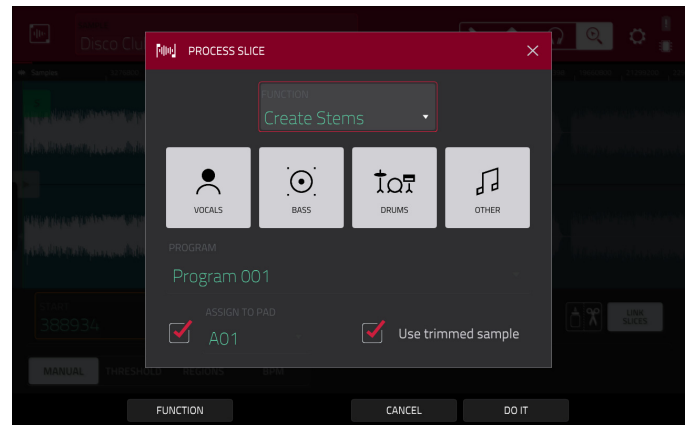

## Program Edit Mode



Program Edit Mode contains all parameters for editing your Programs.

For **drum programs**, this mode includes the parameters of four layers as well as all synthesis parameters and insert effect settings. See the [Drum Programs](#) section to learn more.

For **keygroup programs**, this mode contains slightly more parameters than drum programs. See the [Keygroup Programs](#) section to learn more.

For **clip programs**, this mode looks very different from that of other programs due to how clip launching works. See the [Clip Programs](#) section to learn more.

For **plugin programs**, skip to [Plugin Programs](#) to learn more.

For **MIDI programs** and **CV programs**, skip to [MIDI Programs](#) and [CV Programs](#) to learn more.

For more general information on the differences between the types of programs, please see [General Features > Programs](#).

To enter Program Edit Mode, do either of the following:

- Press **Menu**, and then tap **Program Edit**.
- Press **Prog Edit** (MPC X, MPC One) or **Edit** (MPC Key 61, MPC Key 37).
- Press and hold **Mode** and press **Pad 6** (MPC Studio).

## Drum Programs

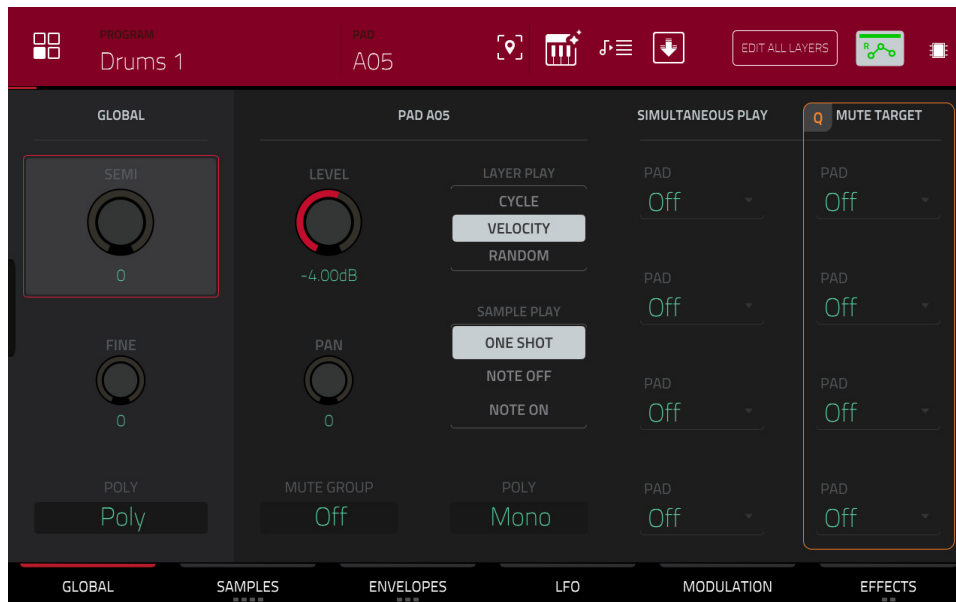

When using drum programs, Program Edit Mode lets you edit the parameters for each pad.

**To select a pad**, press it. Its parameters will appear on the screen immediately.

**To view a specific tab of parameters**, tap the **Global**, **Samples**, **Envelopes**, **LFO**, **Modulations**, or **Effects** button at the bottom of the screen. You can tap the **Samples**, **Envelopes** or **Effects** buttons multiple times to cycle through the available tabs

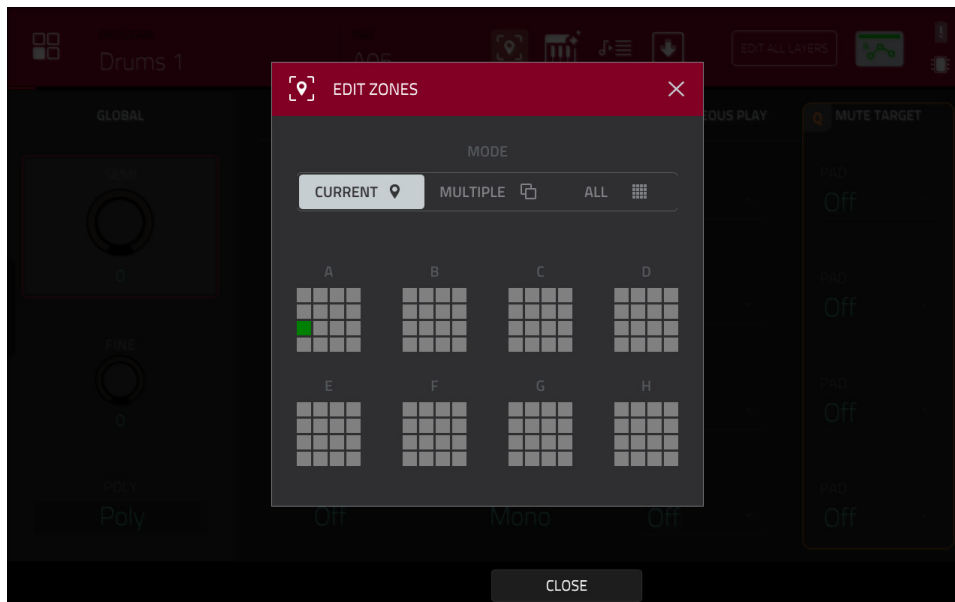

Tap the **location icon** at the top of the screen to open the **Edit Zones** window, which is a feature for drum programs and clip programs. This window displays an overview of any selected pads. Use the **Mode** selector to set how the selected pads will be edited:

**Current:** Only the currently selected pad can be edited.

**Multiple:** All selected pads can be edited simultaneously.

**All:** All pads can be edited simultaneously.

**To close the window**, tap **Close**, the **X**, or anywhere outside the window.

**Tip:** You can immediately select multiple pads while on any tab in Program Edit Mode (regardless of the current Edit Zones setting) by pressing and holding the **Shift** button and pressing each desired pad. The Edit Zones setting will automatically change to **Multiple**.

Tap the **keyboard-plus** icon at the top of the screen to quickly convert a drum sample to a new keygroup program.

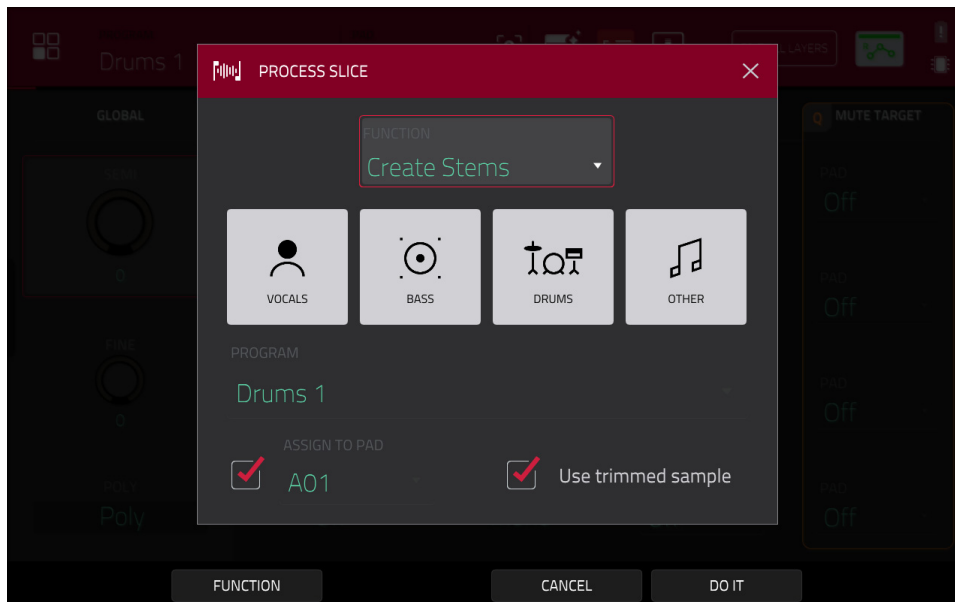

Tap the **Stems** icon to open the Create Stems Function in the Process Sample window. You can use this process to isolate different parts of the sample and separate them into new stem samples.

Click the icons to select or deselect from the following elements to create stems of:

- **Vocals:** Isolate vocal elements of the track into a stem.
- **Bass:** Isolate bass elements of the track into a stem.
- **Drums:** Isolate percussive elements of the track into a stem.
- **Other:** Isolate other musical textures, such as keys or guitars, into a stem.

Use the **Program** dropdown menu to select the program where the stems will be added.

The **Assign to Pad** function determines where the stem separated samples are added. When checked, you can select a pad in the chosen Program using the dropdown menu, and the stems will be added to the four layers of that pad. When unchecked, the stems will be added to the general project sample pool in the **Project Info** Browser.

Tap the **Use trimmed sample** box to trim the source sample between the **Start** and **End** points before applying the stem separation process.

See [Addenda > Updates in MPC 2.15 > New Features > Stem Separation](#) for more information on how to get Stems.

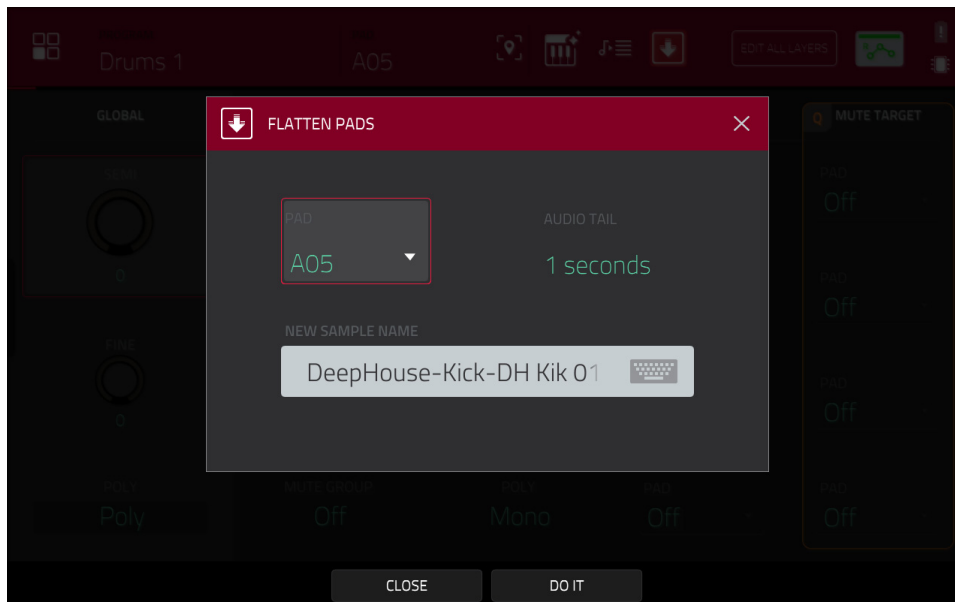

Tap the **down-arrow icon** at the top of the screen (next to the **Program** field) to open the **Flatten Pad** window, which renders all samples on a pad as an audio sample and places it on the first layer of that pad. The resulting sample is the audio signal produced by that pad at full velocity (**127**) after the pad channel strip, which means that it includes any assigned pad insert effects and the results of warping the sample.

This function is useful if you need to reduce how CPU-intensive a pad or program is by essentially “embedding” the warping and effects in the sample itself. By default, it will use the name of the first sample. This function works for drum programs only. (This is the same as the **Flatten Pad** process shown in the program editing functions in Main Mode.)

**To select the pad**, press it or use the **Pad** menu.

**To set the length of the audio tail**, use the **Audio Tail** field. This will add extra seconds to the end of the resulting audio file. This is useful if you are using effects or samples whose sounds exceed the defined audio length (e.g., long reverb or delay, one-shot samples with long decays, etc.). We recommend using an audio tail of at least a couple of seconds.

**To name the new sample**, tap the **Edit Name** field, and use the virtual keyboard that appears.

**To confirm your choice**, tap **Do It**.

**To cancel**, tap **Cancel**.

Tap the **Edit All Layers** button to enable or disable editing control of all sample layers at the same time. When this is enabled, edits made to sample parameters such as **Start/End** points or **Semi/Fine** tuning on any one layer are automatically applied uniformly to all four layers at once (even if some layers are empty). See [Addenda > Updates in MPC 2.15 > New Features > Edit All Layers](#) for more information.

The automation button indicates the global automation state. This is shown in several modes. See [General Features > Automation](#) to learn about this.



## Global

In the Global tab, you can set the playback mode and tuning for the overall Program.

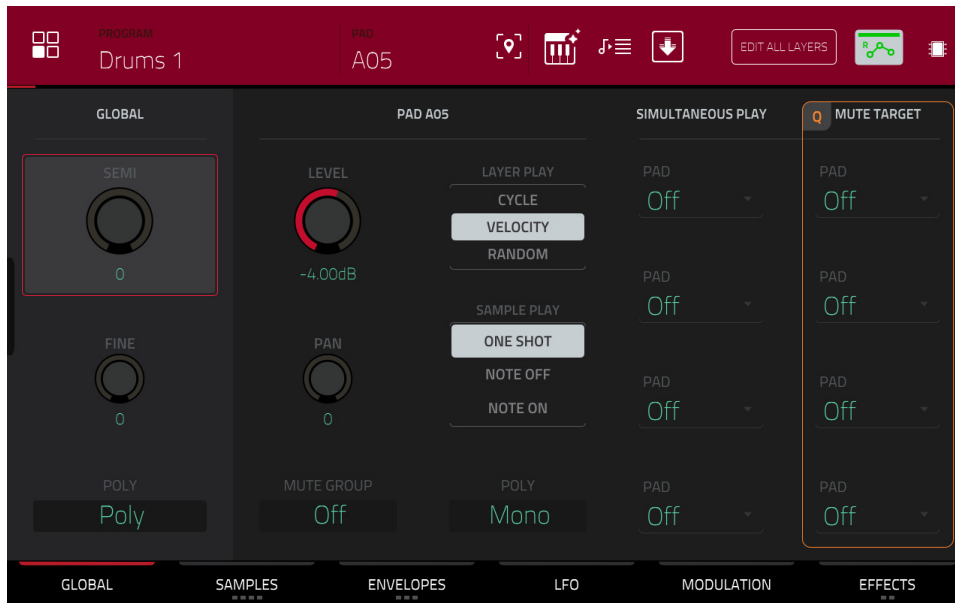

**Semi** lets you transpose the program up to 36 semitones up or down.

**Fine** provides fine-tuning of the program up to 99 cents up or down.

**Poly** (polyphony) sets the playback mode for the program's pads. In **Mono** Mode, only one pad will sound at a time. If a pad is played while another (or the same one) is still playing its sample/samples, the new pad will immediately mute all other currently playing pads in that program. In **Poly** Mode, several pads can be triggered at the same time (limited only by the total number of voices available).

**Level** controls the overall volume level of the loaded sample/samples.

**Pan** controls the overall panning of the loaded sample/samples in the stereo field.

Use the **Mute Group** field to assign the selected pad to one of the 32 available groups. When pads assigned to the same mute group receive MIDI notes, the last pad played will silence all other pads in that mute group. A mute group affects pads within that program only; mute groups do not affect pads in other programs.

**Tip:** This feature is useful for programming realistic hi-hats, especially if only the open or closed hat should be heard.

Use the **Layer Play** selector to determine how multiple samples assigned to the same pad are played:

**Cycle:** Each time the pad is played, it will play the next layer's sample. In other words, the samples will cycle through the layers as follows: 1, 2, 3, 4, 1, 2, 3, 4... etc.

**Velocity:** The pad will switch between layers depending on how hard you press a pad.

**Random:** Each time the pad is played, it will play one of its layer's samples at random.

Use the **Sample Play** selector to determine how much of the sample is played.

**One Shot:** The entire sample will play from start to end. Use this when you want to play short sounds.

**Note Off:** The entire sample will play from start to end after the pad has been pressed and released.

**Note On:** The sample will play only as long as the pad is held. This is better for longer samples so you can control a sound's duration by pressing and holding its corresponding pad.

Use the **Pad Polyphony** field to determine how the pad's sound behaves when multiple hits are registered. When set to **Mono**, only one pad will sound at a time. If a pad is played while another (or the same one) is still playing its sample/samples, the new pad will immediately mute all other currently playing pads in that program. When set to **Poly**, several pads can be triggered at the same time (limited only by the total number of voices available). You can also select a specific number of pads (**2-32**) so that you can trigger up to this many pads at the same time (unless they exceed the total number of voices available).

The **Simultaneous Play** section lets you set up to four pads that can be triggered by pressing one pad only. This function is useful for triggering a stack of sounds (e.g., layered kick drums). Use each **Pad** field to select the desired pad.

The **Mute Target** section lets you select up to four pads (in the same program) for the currently selected pad. When the currently selected pad is played, it will immediately silence its mute targets. Use each **Pad** field to select the desired mute target.

**Tips:**

This feature is useful for programming realistic hi-hats, especially if only the open or closed hat should be heard.

This feature is similar to the mute group feature, available for both drum programs and keygroup programs.

## Samples

Each pad can trigger up to four samples, which are assigned in four individual layers. Each layer has identical, independently assignable parameters.

Tap **Samples** to cycle through its four available tabs.

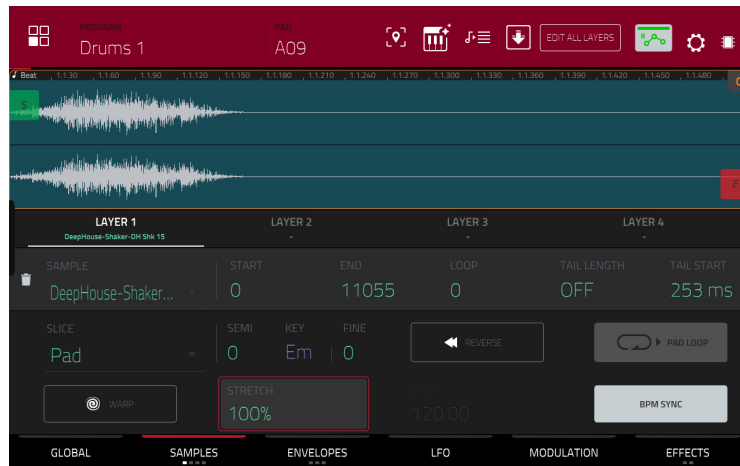

On all four sections, you can access the **Settings** window, which lets you configure certain settings in the Samples tab.

**To view the Settings**, tap the **gear icon**.

**To close the Settings**, tap **Close**, the **X** in the upper-right corner, or anywhere outside the window.

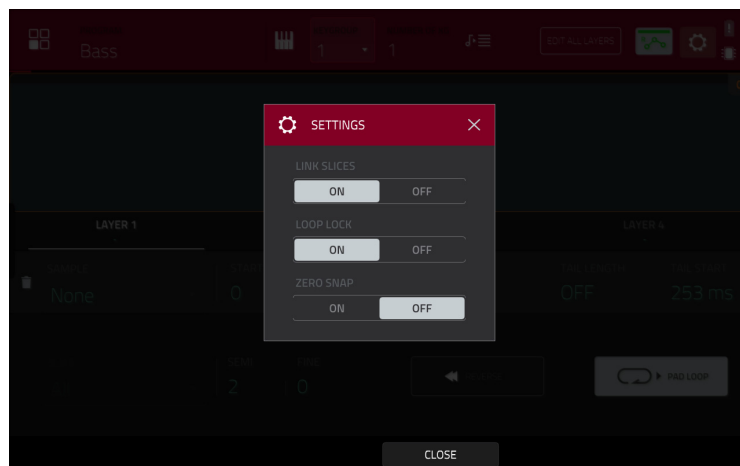

Use the **Link Slices** selector to set how the start point and end point of a slice in a larger sample is set. You can create these slices in Sample Edit Mode (Chop Mode).

When on, changing the start point of a slice will also change the end point of the previous slice. Similarly, changing the end point of a slice will also change the start point of the next slice. Disable **Link Slices** if you are trying to create slices that use non-contiguous parts of the sample. This is the same as the **Link Slices** button in Sample Edit Mode.

Use the **Loop Lock** selector to “link” or “unlink” the loop point from the start point. When on, the loop point is the same as the start point. When off, the loop point is independent from the start point and indicated by a separate loop marker. This is the same as the **Loop Lock** button in Sample Edit Mode.

Use the **Zero Snap** selector to enable or disable the Zero Snap feature, which forces start points, end points, and loop points to occur only at the waveform’s “zero-crossings.” This can help to avoid clicks and glitches when playing a sample. This is the same as the **0 Snap** button in Sample Edit Mode.

The **first Samples** tab contains the sample waveform for each layer and controls for its pitch, timing, and playback.

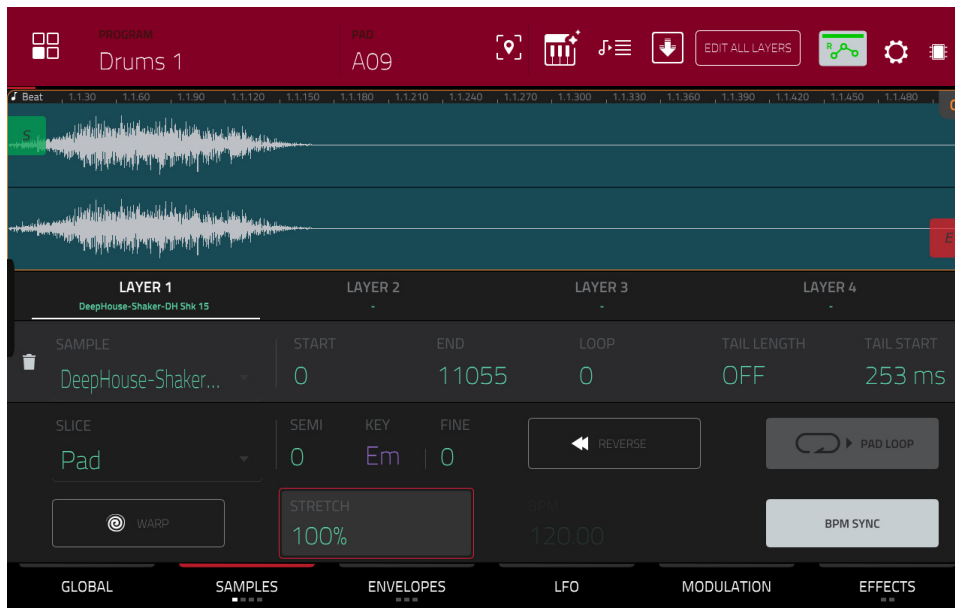

The upper half of the screen shows the waveform of the sample on the currently selected layer. The lower half shows the editing controls.

The waveform display shows the “active” section of the sample waveform. Swipe left or right on the waveform to move through it.

Above the waveform is the timeline, shown in bars, beats, and ticks.

Use the bottom-most **Q-Link knob** in the fourth bank to zoom in or out of the sample waveform.

Tap each layer number (**Layer 1–4**) under the waveform to select it. When selected, its sample waveform will be shown in the upper half of the screen and its settings will be shown in the lower half.

Use the **Sample** field to select the sample file for that layer. Remember that the sample has to be loaded into the project’s sample pool beforehand. For information on how to load samples into a project, please see the [Browser](#) chapter.

**Important:** The parameters in the **Samples** tabs work in conjunction with Chop Mode (in Sample Edit Mode). Here’s how it works:

When working in Sample Edit Mode and using Chop Mode to divide a sample into slices for your pads, you can convert a slice using **Non-Destructive Slice** or **Pad Parameters**.

A **Non-Destructive Slice** will let its pad to refer to that slice when you press it; the original sample remains intact and each slice marker is like a “bookmark” for a pad. In Program Edit Mode, you’ll see that the pad/layer to which it’s assigned has its **Slice** drop-down menu set to the corresponding **slice number** in the original sample. Playing that pad will cause it to refer to that slice marker like a “bookmark” instead of creating an entirely new sample of that slice. This means that you no longer have to clutter your project with a new sample for every slice (though you can still use this earlier method, if you prefer).

A slice converted using **Pad Parameters** is very similar to a non-destructive slice described above. The difference is that in Program Edit Mode, the pads/layers they’re assigned to have their **Slice** drop-down menus set to **Pad** (instead of the slice number), and the **start** and **end points** will correspond to the slice markers in the original sample.

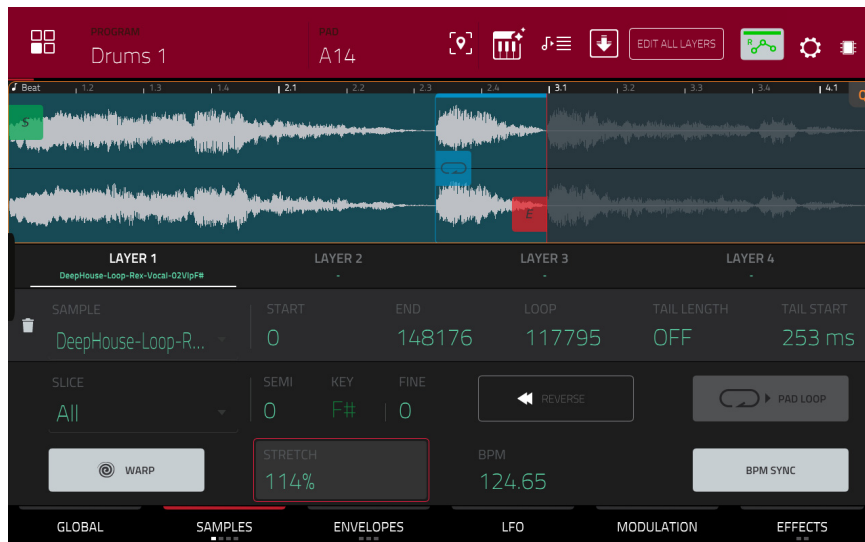

The **green/S** marker and **red/E** marker are the start point and end point (respectively). These two points define the region of the sample that will be played.

To move the start point or end point, do any of the following:

- Tap and drag the **S** or **E** marker left or right.
- Use the **Start** or **End** fields shown below the waveform.
- Use the **first** bank of **Q-Link knobs** to adjust the start point or the **second** bank of **Q-Link knobs** to adjust the end point. The top-most Q-Link knob provides coarse adjustment. The bottom-most Q-Link knob provides fine adjustment.

**Note:** When **Loop Lock** is on, the loop position (as determined by the **Loop** field, if enabled) is the same as the sample's start point. When off, the loop position is independent from the start point.

Use the **Loop** field to determine the position where the sample's playback will repeat when **Pad Loop** is activated. Alternatively, use the **third** bank of **Q-Link knobs** to adjust the loop point. The top-most Q-Link knob provides coarse adjustment. The bottom-most Q-Link knob provides fine adjustment.

**Note:** When **Loop Lock** is on, the loop position is the same as the sample's start point. When off, the loop position is independent from the start point.

Use the **Tail Length** and **Tail Loop** fields to add adding extra audio tail to any chopped sample. This is useful for things like making an abrupt end to a sample sound more natural or adding experimental looping effects to a sample. The **Tail Length** parameter enables the sample tail and set its total length, and the **Tail Loop** parameter sets the starting point within the tail for looping.

Use the **Slice** field to select what part/parts of the sample will play:

**All:** The entire sample will play.

**Pad:** The sample will play from the **Pad Start** position to the **Pad End** position, described **earlier**. This also lets you activate **Pad Loop** (if the **Sample Play** field in the **LFO Modulation** tab is set to **Note On**).

**Slice 1, 2, 3, etc.:** If you have sliced the sample in Chop Mode, you can select which slice will play when you trigger the pad.

**Semi** lets you transpose the selected layer 36 up to semitones up or down. This will affect the length of the sample (if **Warp** is off). This is the same as the **Semi** knob on the second Samples tab. The analyzed **Key** of the sample is displayed next to the **Semi** field and will adjust based on this value.

**Fine** provides fine-tuning of each layer by cents. This will affect the length of the sample (if **Warp** is off). This is the same as the **Fine** knob on the second Samples tab.

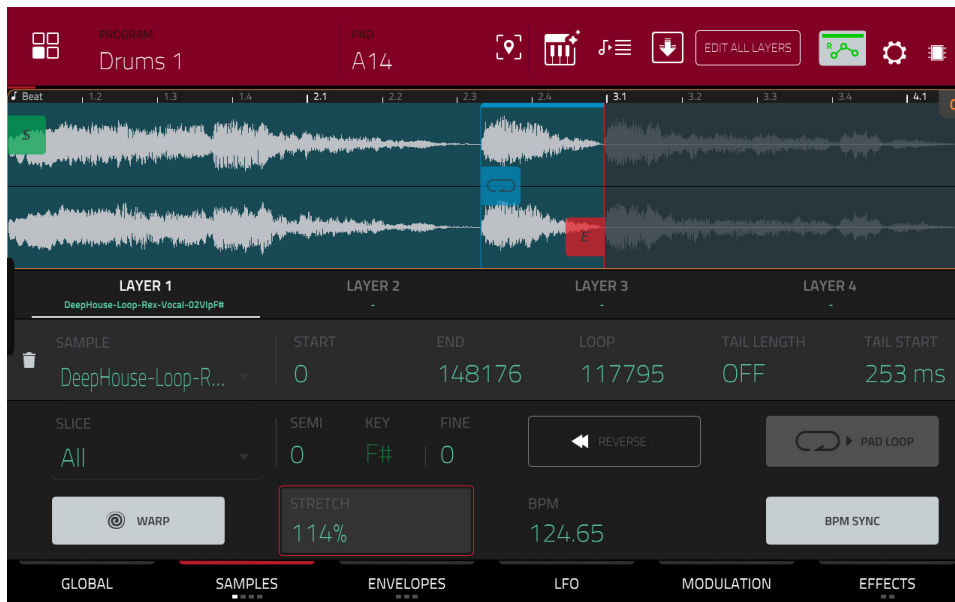

Use the **Reverse** button to select in which direction the sample will play. When on, the sample will play in reverse. When off, the sample will play in the normal forward direction.

Use the **Pad Loop** button to cycle through the available Pad Loop modes.

**Important:** For Pad Loop to work, you must (1) set the **Sample Play** field (in the **LFO Modulation** tab) to **Note On** instead of One Shot and (2) set the **Slice** field (in the first **Samples** tab) to **Pad** instead of All or a slice number.

**Off:** The sample will not loop.

**Forward:** You can hold down the **pad** to cause that sample to repeat from the **Loop Position** to the end of the sample. Release the **pad** to stop the repeating playback.

**Reverse:** You can hold down the **pad** to cause that sample to play in reverse, repeating from the end of the sample to the **Loop Position**. Release the **pad** to stop the repeating playback.

**Alternating:** You can hold down the **pad** to cause that sample to play from the **Loop Position** to the end of the sample and then play in reverse until it reaches the **Loop Position** again. This will repeat as long as you are holding the pad down. Release the **pad** to stop the repeating playback.



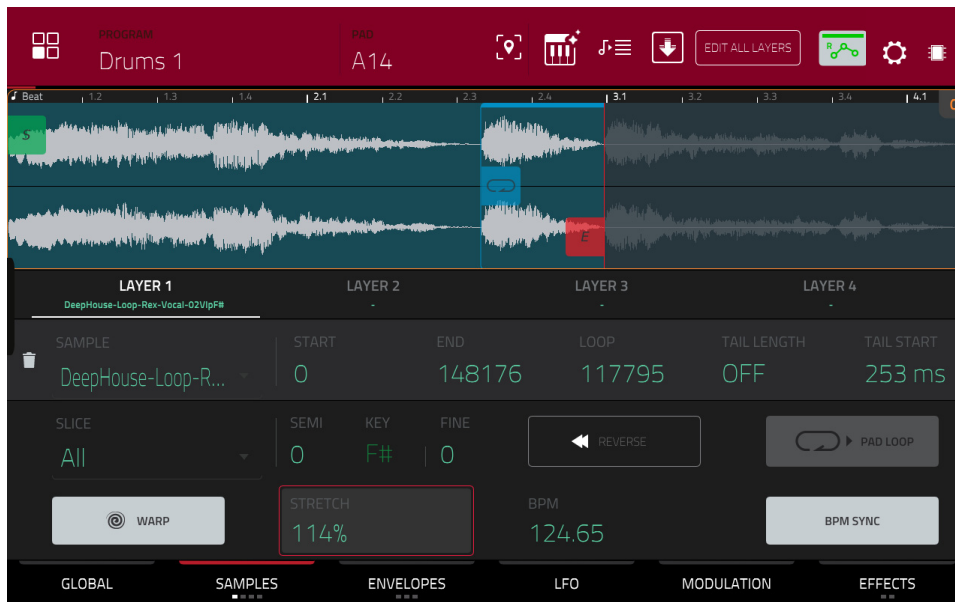

Tap **Warp** to enable or disable warping of the sample.

When enabled, lengthening or shortening the sample (based on the BPM) will not change its pitch.

When disabled, lengthening or shortening the sample will also change its pitch and vice versa.

Use the **Stretch** field to set the “stretch factor,” which affects how the sample is warped (if **Warp** is on).

Use the **BPM** field to enter a tempo, which affects how the sample is warped (if **Warp** is on).

Tap **BPM Sync** to enable or disable BPM Sync.

When BPM Sync and **Warp** are both enabled, the sample’s BPM will be “locked” to the tempo of the sequence.

When BPM Sync is disabled but **Warp** is enabled, the sample will be independent of the tempo of your sequence—use the **Stretch** field to lengthen or shorten a sample.

**Note:** The Warp algorithms are very CPU-intensive and can result in audio drop-outs during playback if used too freely. Be mindful of how (and how often) you use the warp function. You can reduce the CPU resources required by doing any/all of the following:

Avoid using extreme **Stretch** values.

Minimize the amount of pitch adjustment (e.g., the **Semi** and **Fine** parameters) of warped audio.

Avoid warping very small track regions.

Warp as few tracks or track regions as possible (i.e., reduce the number of total number of voices of the polyphonic limit that use the Warp algorithm at a given time), especially instances where the warped regions start at the same time.

Avoid rapidly triggering samples that are warped.

If you have warped samples used in a drum program, consider using the **Flatten Pad** function to consolidate the affected pad’s layers into one audio sample (see [here](#) to learn about this). After you flatten the pad, its sample/samples no longer need to be warped.

The **second Samples** tab contains controls for its pitch, volume level and panning.

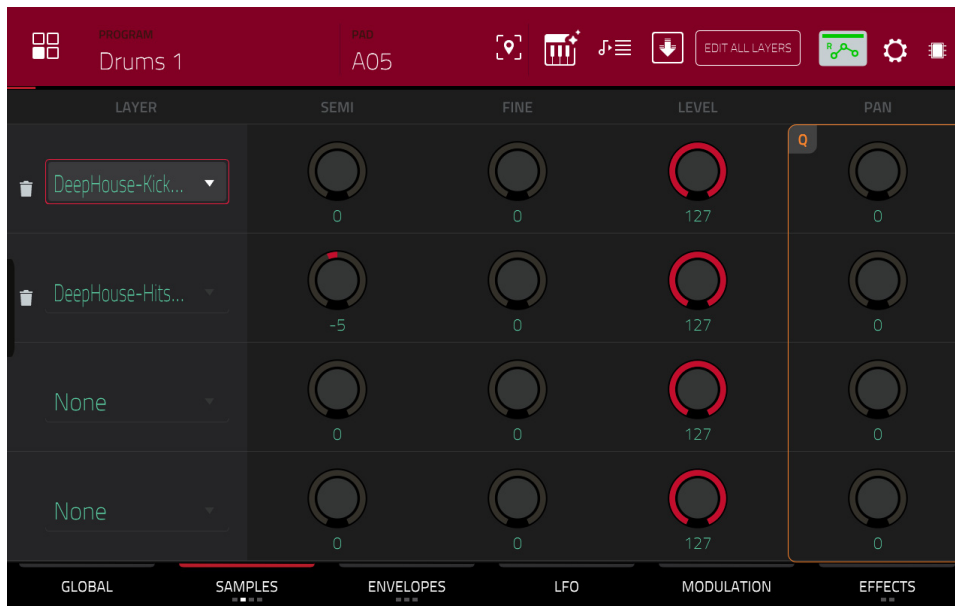

**Semi** lets you transpose the selected layer up to 36 semitones up or down. This will affect the length of the sample (if **Warp** is off). This is the same as the **Semi** field on the first Samples tab.

**Fine** provides fine-tuning of each layer by cents. This will affect the length of the sample (if **Warp** is off). This is the same as the **Fine** field on the first Samples tab.

**Level** lets you adjust each layer's volume, letting you control the "balance" of the samples assigned to the pad.

**Pan** adjusts the stereo placement of the respective layer.



The **third Samples** tab contains the control for its offset and velocity range.

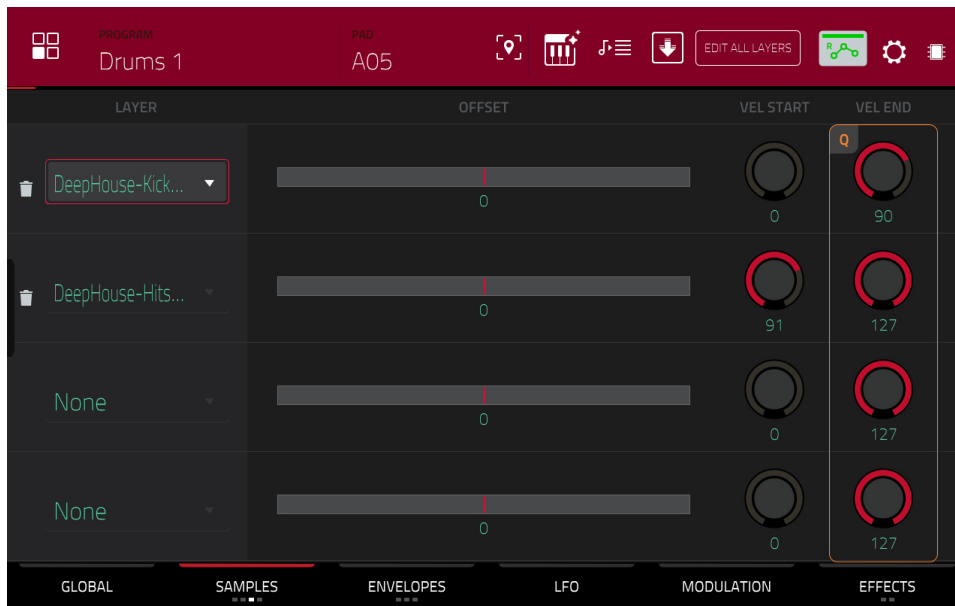

Use the **Offset** slider to determine a time offset for the sample's playback.

**Positive values** (right of center): When the pad is played, playback will start immediately but at a later point in the sample specified by the offset value.

**Negative values** (left of center): When the pad is played, playback will be delayed by the amount specified by the offset value.

Use the **Vel Start** and **Vel End** knobs to define the velocity range of each layer.

A range from **0** to **127** lets the layer respond to the entire velocity range which is input from the respective pad while, for example, a range from **100** to **127** lets the layer respond only to higher velocity levels. By assigning several samples of one instrument, you can create a realistic-sounding "multi-sample" by adjusting the velocity ranges of each layer accordingly.

For example, you may have three samples of a drum hit with low force, medium force, and high force. You can set each sample to a layer and set the Velocity ranges so only low velocities trigger the low-force sample, only mid-range velocities trigger the medium-force sample, and only high velocities trigger the high-force sample.

The **fourth Samples** tab contains the controls for adding randomization to sample parameters such as pitch, level and panning.



Use the **Pitch** knobs to adjust the amount of randomization applied to each sample layer's pitch.

Use the **Level** knobs to adjust the amount of randomization applied to each sample layer's volume.

Use the **Pan** knobs to adjust the amount of randomization applied to each sample layer's stereo placement.

Use the **Offset** knobs to adjust the amount of randomization applied to each sample layer's time offset.

The **All Layers** section will apply randomization to all sample layers for the following envelope parameters: **Attack**, **Decay**, **Cutoff** and **Resonance**. Use the **Depth** slider to control the amount of envelope randomization applied overall.

## Envelopes

Tap **Envelopes** to cycle through its three available tabs.

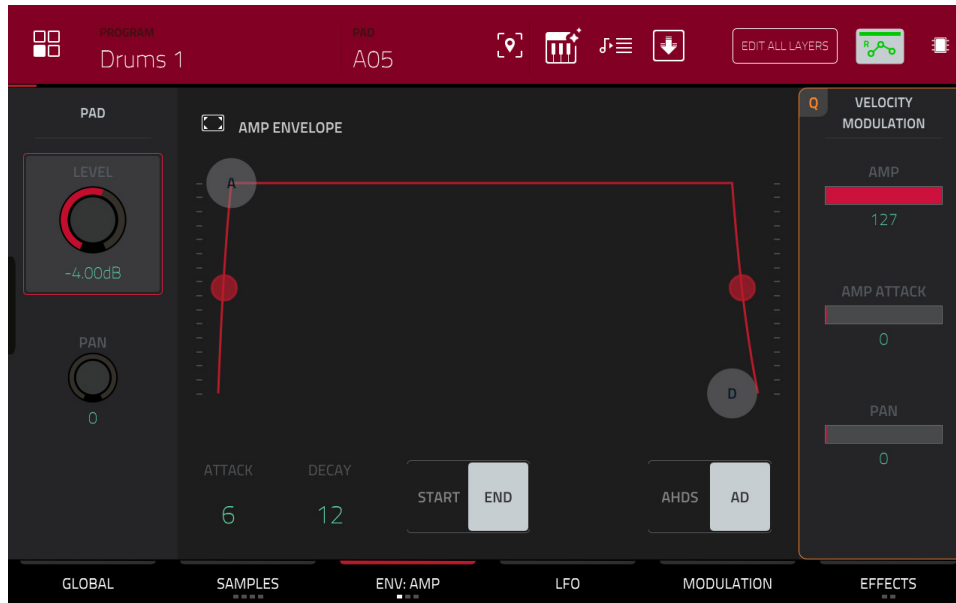

The **first Envelope** tab contains the amplitude modulation envelope.

**Pad Level** controls the overall volume level of the loaded sample/samples.

**Pad Pan** controls the overall panning of the loaded sample/samples in the stereo field.

The **Amp Envelope** controls affect level changes over time. Use the fields or tap and drag the “handles” of the envelope to shape the envelope or time-variant modulation output. Adjust the envelope’s influence on the filter frequency with the **Env** knob. See the later [Anatomy of an Envelope](#) section to learn about the envelope parameters.

The **Velocity Modulation** controls determine how much the velocity affects the volume level of the amplitude envelope (**Amp**), the attack of the amplitude envelope (**Amp Attack**), and/or the panning of the sound (**Pan**).

When you press a pad softly, only minimal modulation is applied. When you press it harder, the modulation amount also gets stronger depending on the setting of the corresponding slider.

The **second Envelope** tab contains the filter modulation envelope.

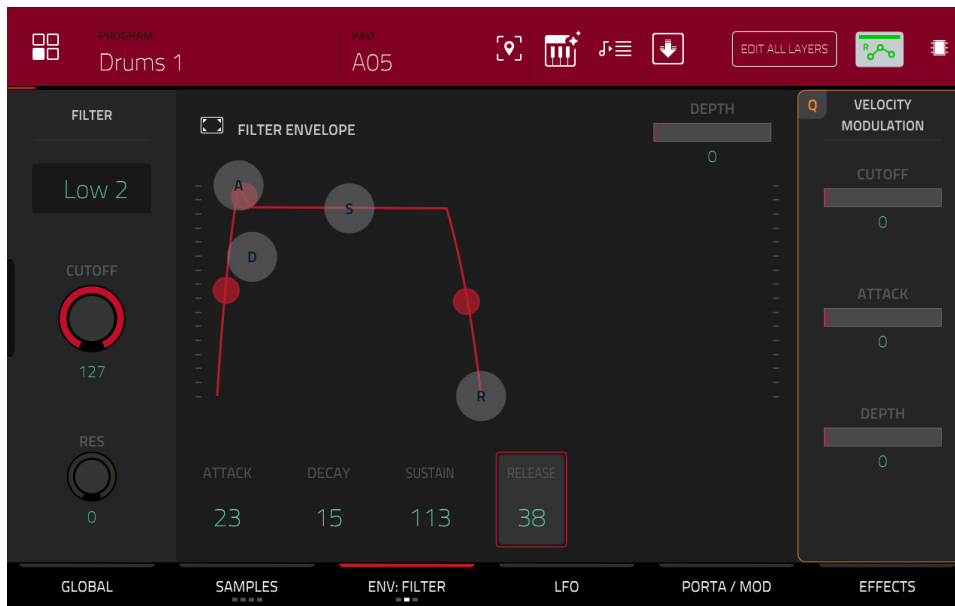

Use the **Type** field to select a filter for the selected pad. See [Appendix > Glossary > Filter](#) for an explanation of the available filter types.

Use the **Cutoff** knob to set the cutoff frequency for low-pass and high-pass filter types or the center frequency for band-pass and band-stop filter types.

Use the **Res** knob to set the resonance/emphasis of the frequencies around the cutoff point.

**Tip:** Use values lower than **80** to give more brilliance to the sound. At values higher than **80**, the sound will result in a strong audible boost around the cutoff frequency.

The **Filter Envelope** controls affect the filter frequency. Use the fields or tap and drag the “handles” of the envelope to shape the envelope or time-variant modulation output. Adjust the envelope’s influence on the filter frequency with the **Depth** knob. See the later [Anatomy of an Envelope](#) section to learn about the envelope parameters.

Use the **Depth** slider to determine the amount of influence the filter envelope has on the cutoff frequency. Higher settings will increase the modulation of the filter by the envelope; lower settings will result in only subtle changes of the filter **Cutoff** over time.

**Tip:** To give a sound a more distinctive attack, increase the **Depth** setting and set low **Attack** and **Decay** values as well as a medium-low **Sustain** value of the **Filter Envelope**. This will start a sound with the filter opened and close it shortly afterward, giving it a bright start followed by a darker sustain. String sounds, on the other hand, can sound much more “alive” with low **Depth** settings and a high **Attack** value, resulting in a slight fade-in of the higher frequencies.

The **Velocity Modulation** controls determine how much the velocity affects the cutoff frequency of the filter envelope (**Cutoff**), the attack phase of the filter envelope (**Attack**), and/or depth of influence the filter envelope has on the cutoff frequency (**Depth**).

When you press a pad softly, only minimal modulation is applied. When you press it harder, the modulation amount also gets stronger depending on the setting of the corresponding slider.

The **third Envelope** tab contains the pitch modulation envelope.

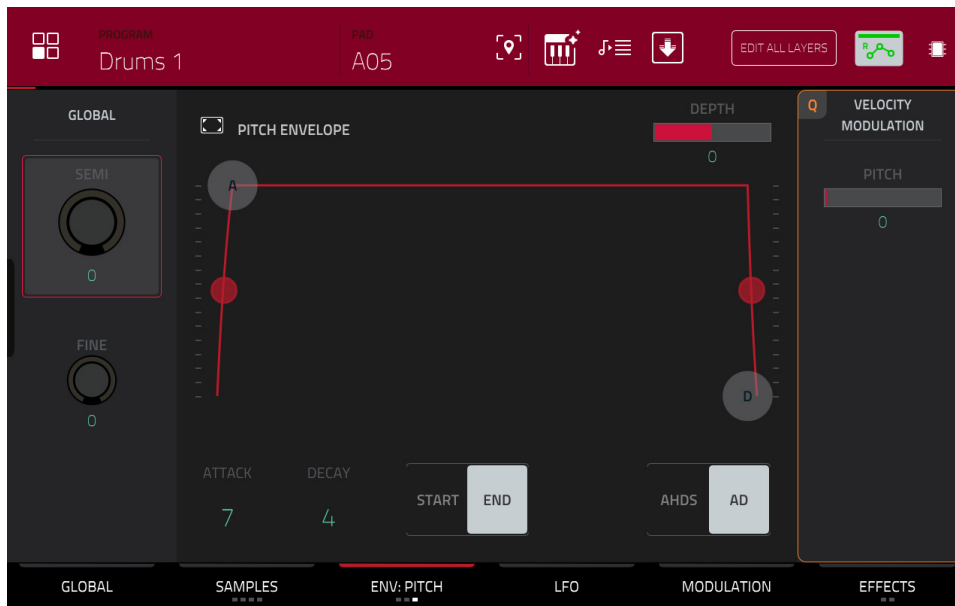

**Global Semi** lets you transpose the pad up to 36 semitones up or down. This will affect the length of the sample (if **Warp** is off). This is the same as the **Semi** field on the **Global** tab.

**Fine** provides fine-tuning of each layer by cents. This will affect the length of the sample (if **Warp** is off). This is the same as the **Fine** field on the **Global** tab.

The **Pitch Envelope** controls affect the pad's pitch. Use the fields or tap and drag the "handles" of the envelope to shape the envelope or time-variant modulation output. Adjust the envelope's influence on the pitch with the **Depth** slider. See the later [Anatomy of an Envelope](#) section to learn about the envelope parameters.

The **Velocity Modulation** control determines how much the velocity affects the pitch envelope (**Pitch**).

When you press a pad softly, only minimal modulation is applied. When you press it harder, the modulation amount also gets stronger depending on the setting of the **Pitch** slider.

## LFO

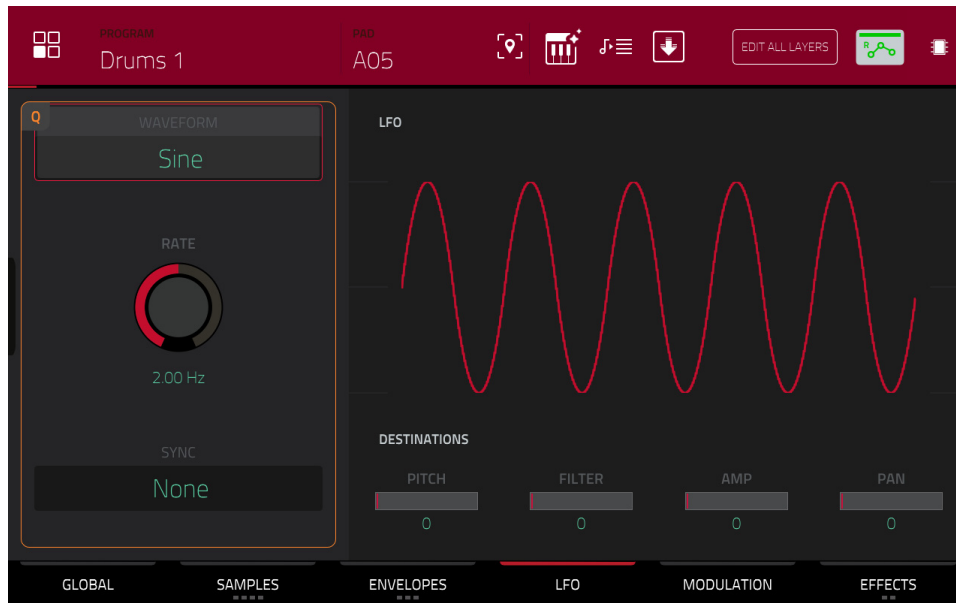

A low-frequency oscillator (LFO) generates a periodic waveform with an adjustable frequency and shape which can be used for modulation purposes.

Use the **Wave** field to select the LFO waveform type:

- Sine** (best suited for smooth modulations)
- Triangle** (best suited for smooth modulations)
- S&H** (samples a random value and holds it until the next value is generated)
- Saw** (can generate interesting filter or volume changes)
- Saw Down** (can generate interesting filter or volume changes)
- Square** (interesting results with hard-panning modulations)
- Noise** (generates random values and glides)

Use the **Rate** field to determine the LFO frequency. At lower values, it might take some time for the LFO to complete a cycle, while higher values will come closer to audible range.

Use the **Sync** field to set if the LFO's rate is synchronized with the tempo. You can select one of several time divisions (a **.** indicates a dotted note; a **T** indicates a triplet-based time division). When **None** is selected, **Sync** is off.

Use the **Destinations** sliders to determine how much the LFO affects the pitch of the sound (**Pitch**), the cutoff frequency of the filter (**Filter**), the volume level of the sound (**Amp**) and panning of the sound (**Pan**).

## Modulations

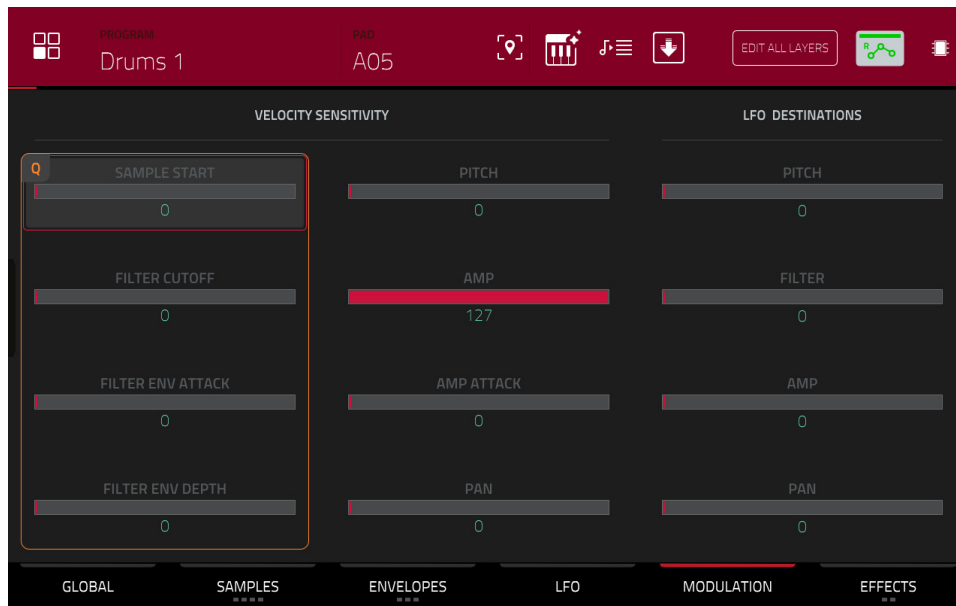

Use the **Velocity Sensitivity** sliders to set how much velocity is required to modulate certain other parameters:

- **Sample Start** sets how much velocity is needed (for a triggered pad) to modulate the sample start point.
- **Filter Cutoff** uses the velocity of a pad to modulate the cutoff frequency directly.
- **Filter Env Attack** sets how much velocity is needed (for a triggered pad) to modulate the Attack phase for the Filter envelope.
- **Filter Env Depth** enables velocity information to control the amount of the filter envelope's effect on the cutoff frequency.
- **Pitch** uses the velocity of a pad to modulate the sample pitch.
- **Amp** uses the velocity of a pad to change the sample level. Lower this value to reduce the effect of velocity on the amplitude.
- **Amp Attack** sets how much velocity is needed (for a triggered pad) to modulate the Attack phase for the Amp envelope.
- **Pan** uses the velocity of a pad to control the stereo panning.

Use the **LFO Destinations** sliders to determine how much the LFO affects the pitch of the sound (**Pitch**), the cutoff frequency of the filter (**Filter**), the volume level of the sound (**Amp**) and panning of the sound (**Pan**).

## Effects

Tap **Effects** to cycle through its two available tabs.

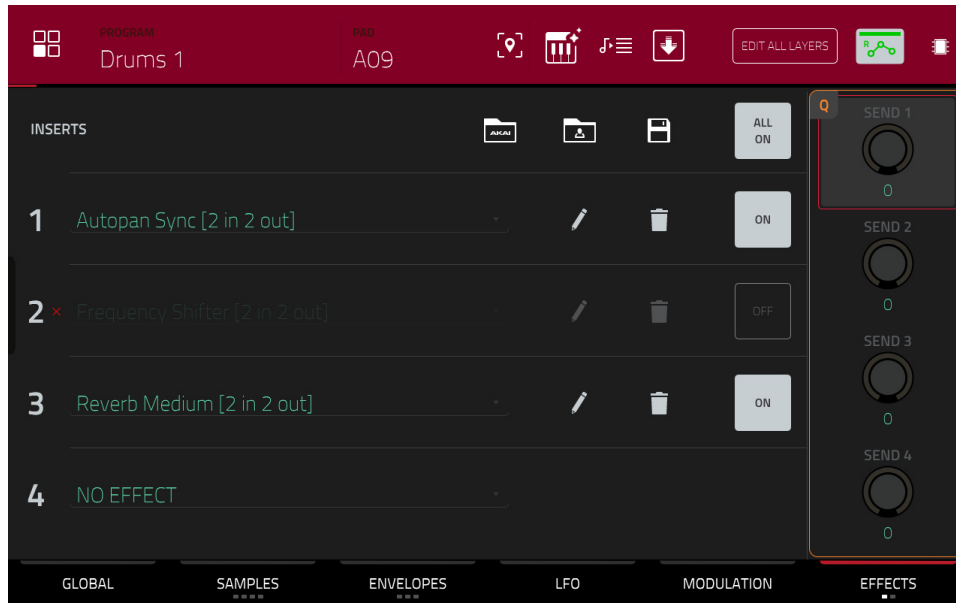

## Inserts

You can select up to four insert effects for each pad. To learn how to use insert effects, please see [General Features > Effects > Insert Effects](#).

### To add an effect:

1. Double-tap the desired **Inserts** slot. A list of effects will appear.
2. Swipe up or down to move through the list.  
You can tap the **Type** and **Manufacturer** buttons to sort your effects by those categories.
3. **To load an effect, double-tap it, or tap Select.**  
**To close the list, tap Close.**

**To remove an effect from its slot, tap the trash can icon.**

**To enable or disable the effect, tap the On/Off button for the slot.**

**To enable or disable all four insert effects, tap the All On/Off button in the upper-right corner.**

**To load a factory FX rack, tap the Akai folder icon.** You can choose from a number of preset combinations of insert effects by applications like Drums and Percussion, Voice, LoFi, Mastering, and more.

**To load a saved FX rack, tap second folder icon.**

**To save an FX rack, tap the disk icon.**



To adjust the effect's parameters, tap the **pencil icon**. Use the **sliders** to set the value of each parameter. These values affect only this instance of the effect; insert effects are not global.

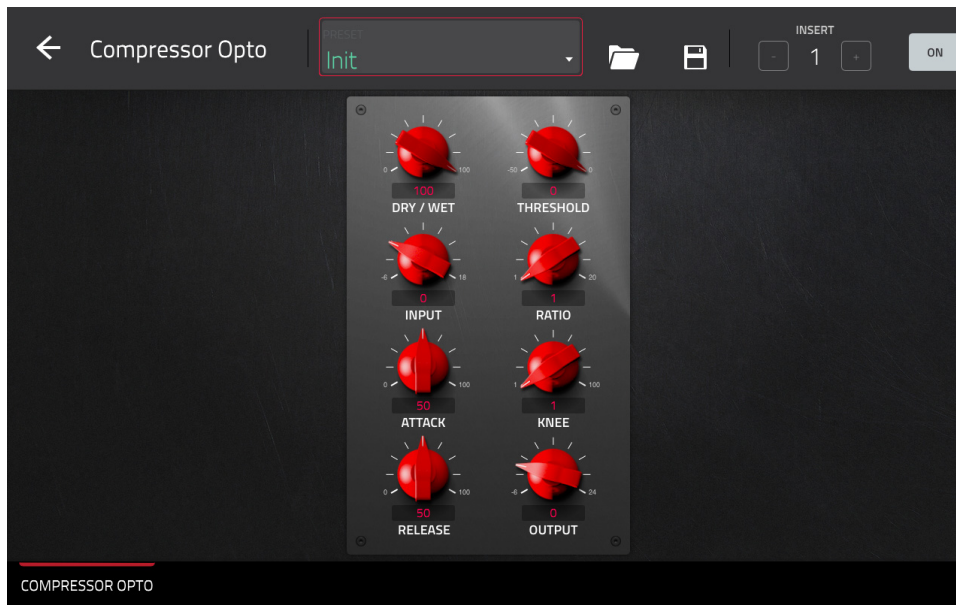

## Sends

The audio of the pad will be routed to send effects (if you have any loaded) at their designated send levels. The return channels will then send the audio to an assigned main output at the designated return levels.

Use the **Send** knobs to set the volume level of the signal the pad will route to each send effect.

**Important:** To set the send level, use, you have to load an effect into the corresponding send effect slot in the Channel Mixer. See [Channel Mixer > Returns](#) to learn more how to do this. To learn about send effects, please see [General Features > Effects > Send/Return Effects](#).

## Drum FX

The **Drum FX** tab lets you add and control up to eight effects per pad in a Drum program. See [Addenda > Updates in MPC 2.10 > New Features > Drum and Keygroup Program Improvements](#) to learn more.

## Keygroup Programs

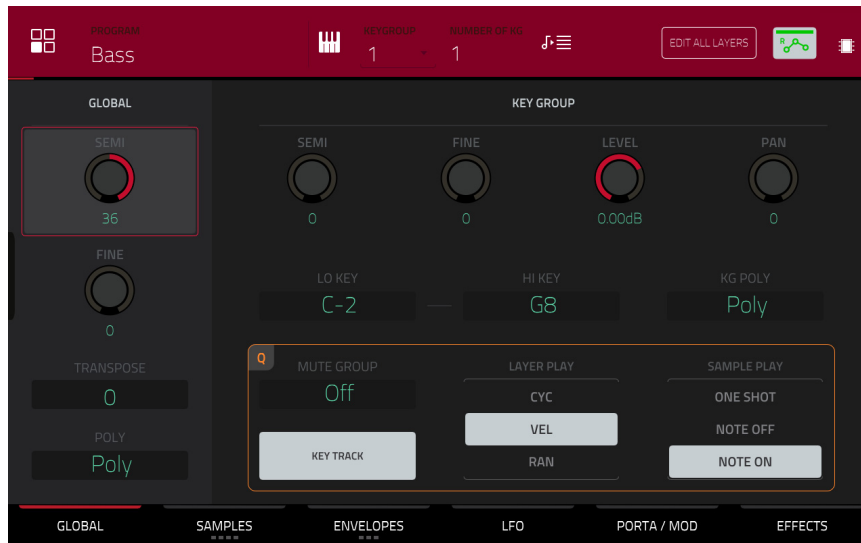

When using keygroup programs, Program Edit Mode lets you edit the parameters for each keygroup.

**To select a keygroup**, press a **pad** within that keygroup. Its parameters will appear on the screen immediately. Alternatively, use the **Keygroup** field at the top of the screen.

**To view a specific tab of parameters**, tap the **Global**, **Samples**, **Envelopes**, **LFO**, **Porta/Mod** or **Effects** button at the bottom of the screen. You can tap the **Samples** and **Envelopes** buttons multiple times to cycle through the available tabs.

Tap the **piano-keys icon** to edit the note range of the current keygroup. This will open the **Set Keygroup Note Range** window. This lets you restrict the key range used for a sample's playback. Only notes with a key number higher or equal (**Low Key**) or lower and equal (**High Key**) to the selected value will trigger a sound.

### Tips:

Alternatively, you can set the current keygroup's note range by using the **Lo** and **Hi** fields under **Note Range** in the **Global** tab.

Set the **Lo** parameter to **A0** and the **Hi** parameter to **C8** to emulate the range of a standard 88-key piano.

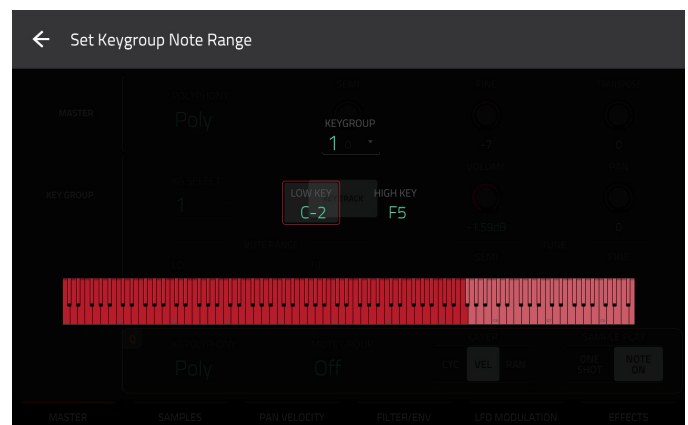

Tap the **Keygroup** field to select a keygroup to edit. You can also select **All** to edit all keygroups simultaneously.

**Number of KG** (keygroups) lets you create and select up to 128 keygroups within a keygroup program. This is useful when working with multi-samples. For example, if you want to create a realistic piano, you can use different keygroups (e.g., 88 for a grand piano) with every keygroup containing its own sampled note (with up to four possible velocity layers). A default keygroup program contains only one single keygroup. When you have created more than one keygroup with **Number of KG**, use **KG Select** to select any keygroup for editing. **All** selects all available keygroups of a keygroup program for simultaneous editing.

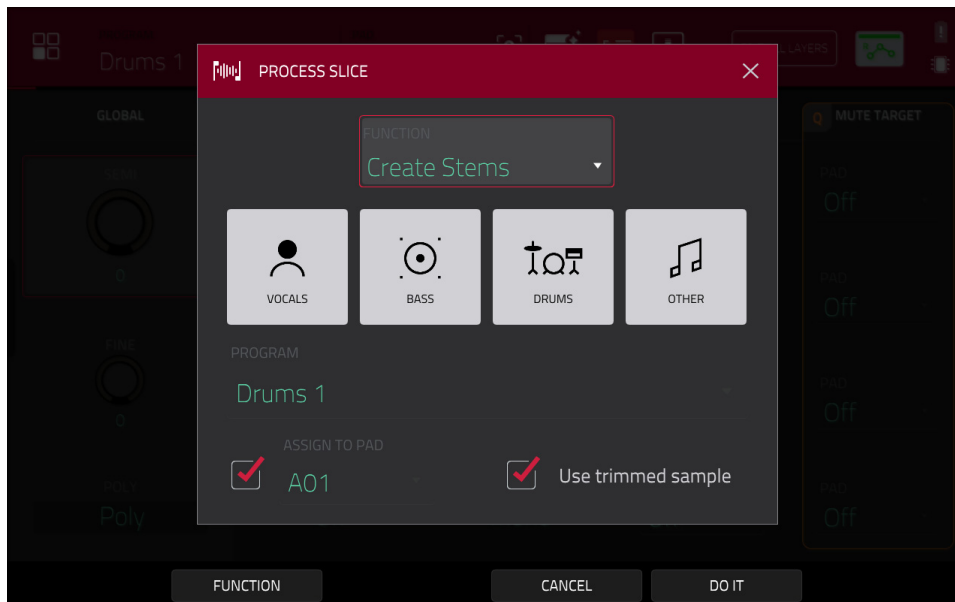

Tap the **Stems** icon to open the Create Stems Function in the Process Sample window. You can use this process to isolate different parts of the sample and separate them into new stem samples.

Click the icons to select or deselect from the following elements to create stems of:

- **Vocals:** Isolate vocal elements of the track into a stem.
- **Bass:** Isolate bass elements of the track into a stem.
- **Drums:** Isolate percussive elements of the track into a stem.
- **Other:** Isolate other musical textures, such as keys or guitars, into a stem.

Use the **Program** dropdown menu to select the program where the stems will be added.

The **Assign to Pad** function determines where the stem separated samples are added. When checked, you can select a pad in the chosen Program using the dropdown menu, and the stems will be added to the four layers of that pad. When unchecked, the stems will be added to the general project sample pool in the **Project Info** Browser.

Tap the **Use trimmed sample** box to trim the source sample between the **Start** and **End** points before applying the stem separation process.

See [Addenda > Updates in MPC 2.15 > New Features > Stem Separation](#) for more information on how to get Stems.

Tap the **Edit All Layers** button to enable or disable editing control of all sample layers at the same time. When this is enabled, edits made to sample parameters such as **Start/End** points or **Semi/Fine** tuning on any one layer are automatically applied uniformly to all four layers at once (even if some layers are empty). See [Addenda > Updates in MPC 2.15 > New Features > Edit All Layers](#) for more information.

The automation button indicates the global automation state. This is shown in several modes. See [General Features > Automation](#) to learn about this.

## Global

In the Global tab, you can set the playback mode and tuning for the overall program.

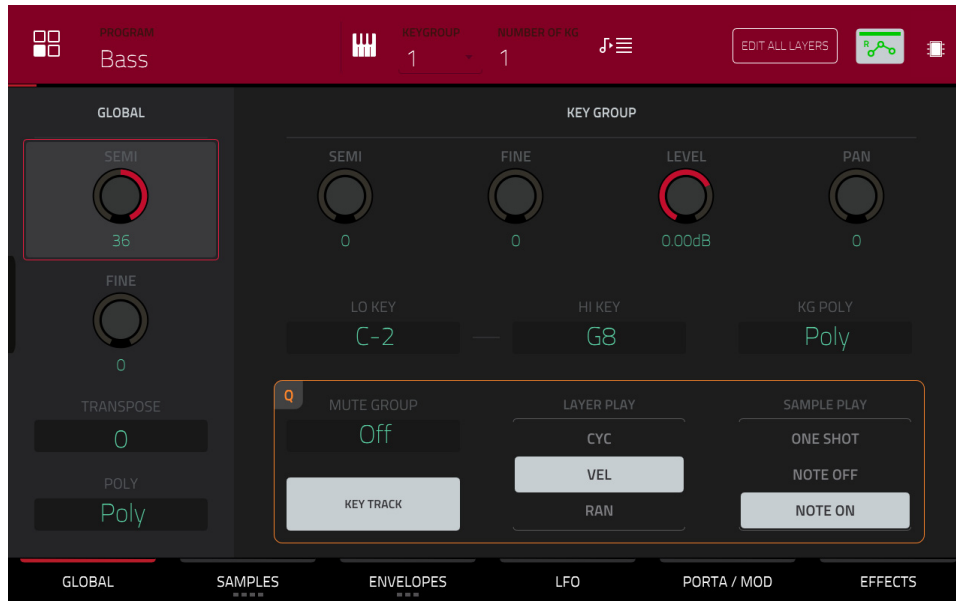

**Global Semi** lets you tune the program up to 36 semitones up or down.

**Global Fine** provides fine-tuning of the program up to 99 cents up or down.

**Transpose** shifts the pitch of the MIDI notes sent to the program up to 36 semitones up or down.

**Polyphony** sets the playback mode for the program's keygroups. In **Mono** Mode, only one keygroup will sound at a time. If a keygroup is played while another (or the same one) is still playing its sample/samples, the new keygroup will immediately mute all other currently playing keygroups in that program. In **Poly** Mode, several keygroups can be triggered at the same time (limited only by the total number of voices available).

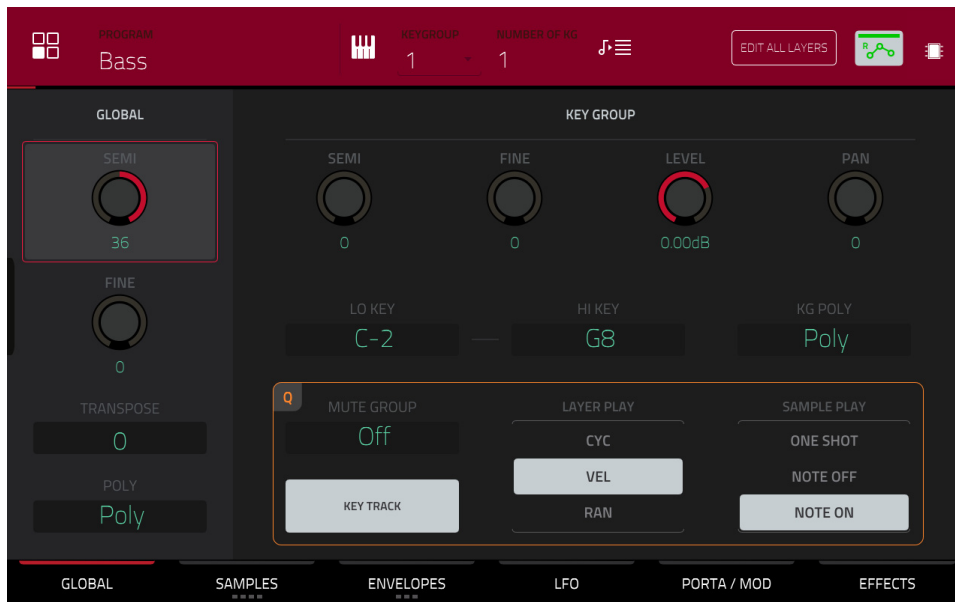

**Key Group Semi** lets you transpose the sample 36 semitones up or down, while **Key Group Fine** provides fine-tuning of each layer up to 99 cents up or down.

**Tip:** The **Edit Layers** section has some parameters similar to those in this section (**Level, Pan, Semi, Fine, Note Range**). Remember that **Key Group** parameters control the overall settings for the sample, while **Edit Layer** parameters control the settings for each layer (up to 4).

**Level** controls the overall volume level of the loaded sample/samples.

**Pan** controls the overall panning of the loaded sample/samples in the stereo field.

The **Lo Key** and **Hi Key** fields let you restrict the key range used for a sample's playback. Only notes with a key number higher or equal (**Lo**) or lower and equal (**Hi**) to the selected value will trigger a sound. The settings for **Lo** and **Hi** are also shown in the virtual keyboard in the **Edit Layers** section. Alternatively, tap the **piano-keys icon** to open the **Set Keygroup Note Range** window.

**Tip:** Set the **Lo** parameter to **A0** and the **Hi** parameter to **C8** to emulate the range of a standard 88-key piano.

Use the **KG Poly** (keygroup polyphony) field to determine how the keygroup will play. When set to **Mono**, only one pad will sound at a time. If a pad is played while another (or the same one) is still playing its sample/samples, the new pad will immediately mute all other currently playing pads in that program. When set to **Poly**, several pads can be triggered at the same time, limited only by the total number of voices available. You can also select a specific number of pads (**2–32**) so that you can play up to this many pads at the same time (unless they exceed the total number of voices available).

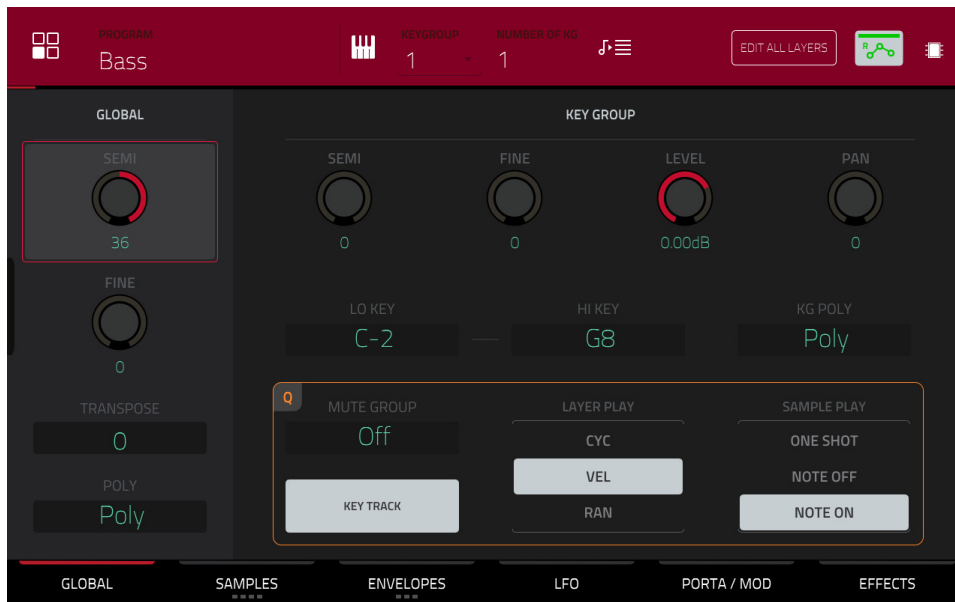

**Mute Group** allows you to assign the selected pad to one of the 32 available groups. When pads assigned to the same mute group receive MIDI notes, the last pad played will silence all other pads in that mute group. A mute group affects pads within that program only; mute groups do not affect pads in other programs.

**Key Track** allows you to switch a sample's automatic transposition on or off. If this is off, you will always hear the same pitch of the sample, no matter which note is triggered by pads or a connected MIDI keyboard.

**Layer Play** determines how multiple samples assigned to the same pad are played:

- **Cycle (Cyc):** Each time the pad is played, it will play the next layer's sample. In other words, the samples will cycle through the layers as follows: 1, 2, 3, 4, 1, 2, 3, 4... etc.
- **Velocity (Vel):** The pad will switch between layers depending on how hard you press a pad.
- **Random (Ran):** Each time the pad is played, it will play one of its layer's samples at random.

**Sample Play** determines how much of the sample is played:

- **One Shot:** The entire sample will play from start to end. Use this when you want to play short sounds.
- **Note Off:** The entire sample will play from start to end after the pad has been pressed and released.
- **Note On:** The sample will play only as long as the pad is held. This is better for longer samples so you can control a sound's duration by pressing and holding its corresponding pad.

## Samples

Each keygroup can trigger up to four samples, which are assigned in four individual layers. Each layer has identical, independently assignable parameters.

Tap **Samples** to cycle through its four available tabs.

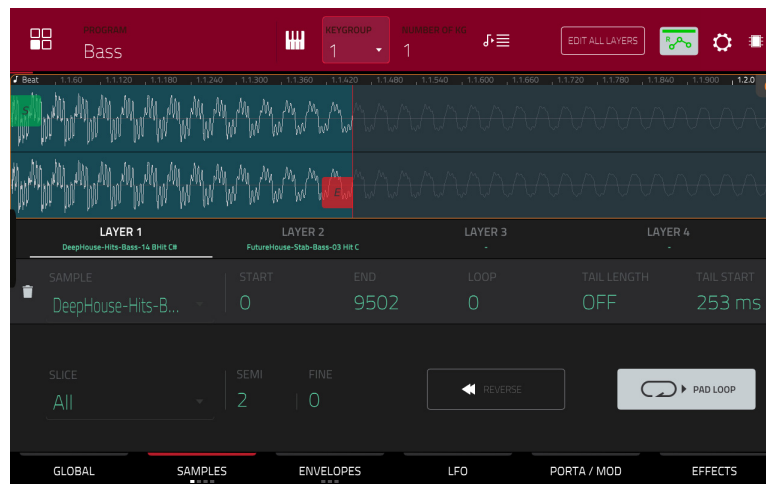

On all four sections, you can access the **Settings** window, which lets you configure certain settings in the Samples tab.

**To view the Settings**, tap the **gear icon**.

**To close the Settings**, tap **Close**, the **X** in the upper-right corner, or anywhere outside the window.

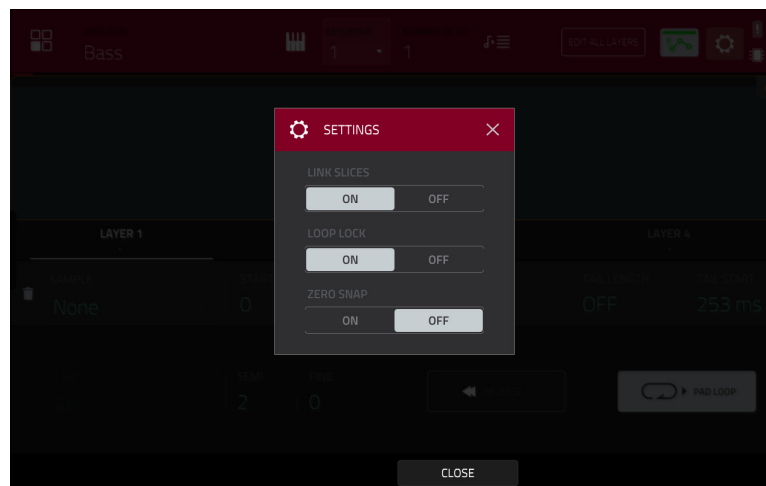

Use the **Link Slices** selector to set how the start point and end point of a slice in a larger sample is set. You can create these slices in Sample Edit Mode (Chop Mode).

When on, changing the start point of a slice will also change the end point of the previous slice. Similarly, changing the end point of a slice will also change the start point of the next slice. Disable **Link Slices** if you are trying to create slices that use non-contiguous parts of the sample. This is the same as the **Link Slices** button in Sample Edit Mode.

Use the **Loop Lock** selector to “link” or “unlink” the loop point from the start point. When on, the loop point is the same as the start point. When off, the loop point is independent from the start point and indicated by a separate loop marker. This is the same as the **Loop Lock** button in Sample Edit Mode.

Use the **Zero Snap** selector to enable or disable the Zero Snap feature, which forces start points, end points, and loop points to occur only at the waveform’s “zero-crossings.” This can help to avoid clicks and glitches when playing a sample. This is the same as the **0 Snap** button in Sample Edit Mode.

The **first Samples** tab contains the sample waveform for each layer and controls for its pitch, timing, and playback.

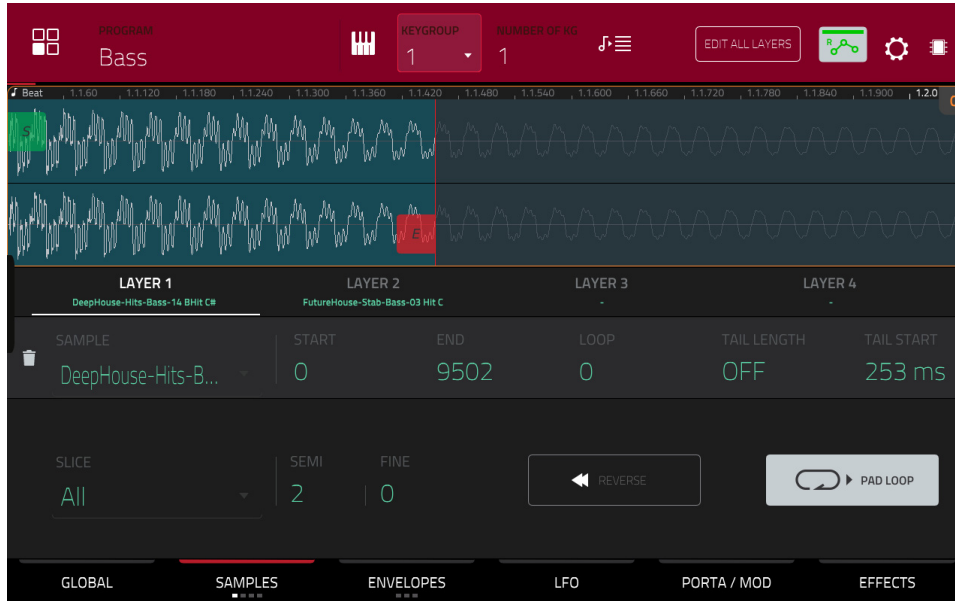

The upper half of the screen shows the waveform of the sample on the currently selected layer. The lower half shows the editing controls.

The waveform display shows the “active” section of the clip waveform. Swipe left or right on the waveform to move through it.

Above the waveform is the timeline, shown in bars, beats, and ticks.

Use the bottom-most **Q-Link knob** in the fourth bank to zoom in or out of the sample waveform.

Tap each layer number (**Layer 1–4**) under the waveform to select it. When selected, its sample waveform will be shown in the upper half of the screen and its settings will be shown in the lower half.

Use the **Sample** field to select the sample file for that layer. Remember that the sample has to be loaded into the project’s sample pool beforehand. For information on how to load samples into a project, please see the [Browser](#) chapter.

**Important:** The parameters in the **Samples** tabs work in conjunction with Chop Mode (in Sample Edit Mode). Here’s how it works:

When working in Sample Edit Mode and using Chop Mode to divide a sample into slices for your pads (keygroups), you can convert a slice using **Non-Destructive Slice** or **Pad Parameters**.

A **Non-Destructive Slice** will let its keygroup to refer to that slice when you press a pad in that keygroup; the original sample remains intact and each slice marker is like a “bookmark” for a keygroup. In Program Edit Mode, you’ll see that the layer to which it’s assigned has its **Slice** drop-down menu set to the corresponding **slice number** in the original sample. Playing that keygroup will cause it to refer to that slice marker like a “bookmark” instead of creating an entirely new sample of that slice. This means that you no longer have to clutter your project with a new sample for every slice (though you can still use this earlier method, if you prefer).

A slice converted using **Pad Parameters** is very similar to a non-destructive slice described above. The difference is that in Program Edit Mode, the layers they’re assigned to have their **Slice** drop-down menus set to **Pad** (instead of the slice number), and the **start** and **end points** will correspond to the slice markers in the original sample.



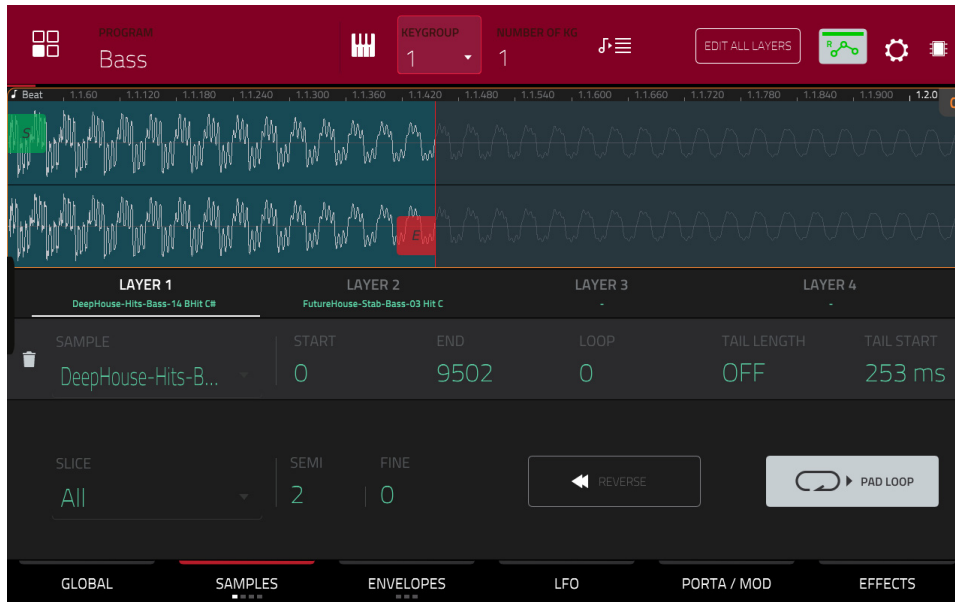

The **green/S** marker and **red/E** marker are the start point and end point (respectively). These two points define the region of the sample that will be played.

To move the start point or end point, do any of the following:

- Tap and drag the **S** or **E** marker left or right.
- Use the **Start** or **End** fields shown below the waveform.
- Use the **first** column of **Q-Link knobs** to adjust the start point or the **second** column of **Q-Link knobs** to adjust the end point. The top-most Q-Link knob provides coarse adjustment. The bottom-most Q-Link knob provides fine adjustment.

**Note:** When **Loop Lock** is on, the loop position (as determined by the **Loop** field, if enabled) is the same as the sample's start point. When off, the loop position is independent from the start point.

Use the **Loop** field to determine the position where the sample's playback will repeat when **Pad Loop** is activated. Alternatively, use the **third** column of **Q-Link knobs** to adjust the loop point. The top-most Q-Link knob provides coarse adjustment. The bottom-most Q-Link knob provides fine adjustment.

**Note:** When **Loop Lock** is on, the loop position is the same as the sample's start point. When off, the loop position is independent from the start point.

Use the **Tail Length** and **Tail Loop** fields to add adding extra audio tail to any chopped sample. This is useful for things like making an abrupt end to a sample sound more natural or adding experimental looping effects to a sample. The **Tail Length** parameter enables the sample tail and set its total length, and the **Tail Loop** parameter sets the starting point within the tail for looping.

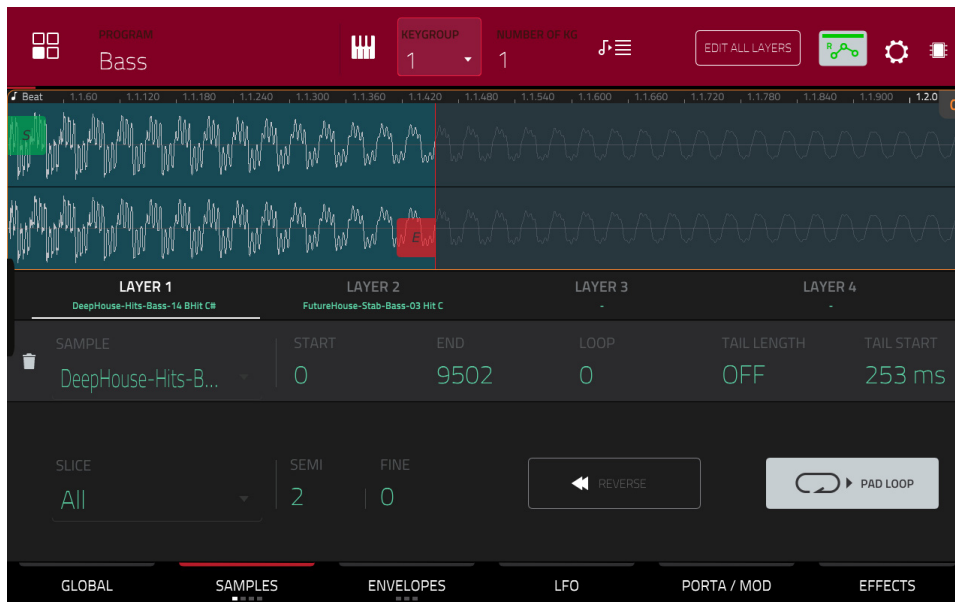

Use the **Slice** field to select what part/parts of the sample will play:

**All:** The entire sample will play.

**Pad:** The sample will play from the **Pad Start** position to the **Pad End** position, described *earlier*. This also lets you activate **Pad Loop** (if the **Sample Play** field in the **Global** tab is set to **Note On**).

**Slice 1, 2, 3, etc.:** If you have sliced the sample in Chop Mode, you can select which slice will play when you trigger the pad.

**Semi** lets you transpose the selected layer 36 up to semitones up or down. This is the same as the **Semi** knob on the second **Samples** tab.

**Fine** provides fine-tuning of each layer by cents. This is the same as the **Fine** knob on the second **Samples** tab.

Use the **Reverse** button to select in which direction the sample will play. When on, the sample will play in reverse. When off, the sample will play in the normal forward direction.

Use the **Pad Loop** button to cycle through the available Pad Loop modes.

**Important:** For Pad Loop to work, you must (1) set the **Sample Play** field (in the **Global** tab) to **Note On** instead of **One Shot** and (2) set the **Slice** field (in the first **Samples** tab) to **Pad** instead of **All** or a slice number.

**Off:** The sample will not loop.

**Forward:** You can hold down the **pad** to cause that sample to repeat from the **Loop Position** to the end of the sample. Release the **pad** to stop the repeating playback.

**Reverse:** You can hold down the **pad** to cause that sample to play in reverse, repeating from the end of the sample to the **Loop Position**. Release the **pad** to stop the repeating playback.

**Alternating:** You can hold down the **pad** to cause that sample to play from the **Loop Position** to the end of the sample and then play in reverse until it reaches the **Loop Position** again. This will repeat as long as you are holding the pad down. Release the **pad** to stop the repeating playback.

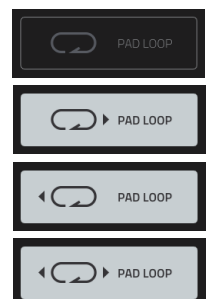

The **second Samples** tab contains controls for its pitch, volume level and panning.

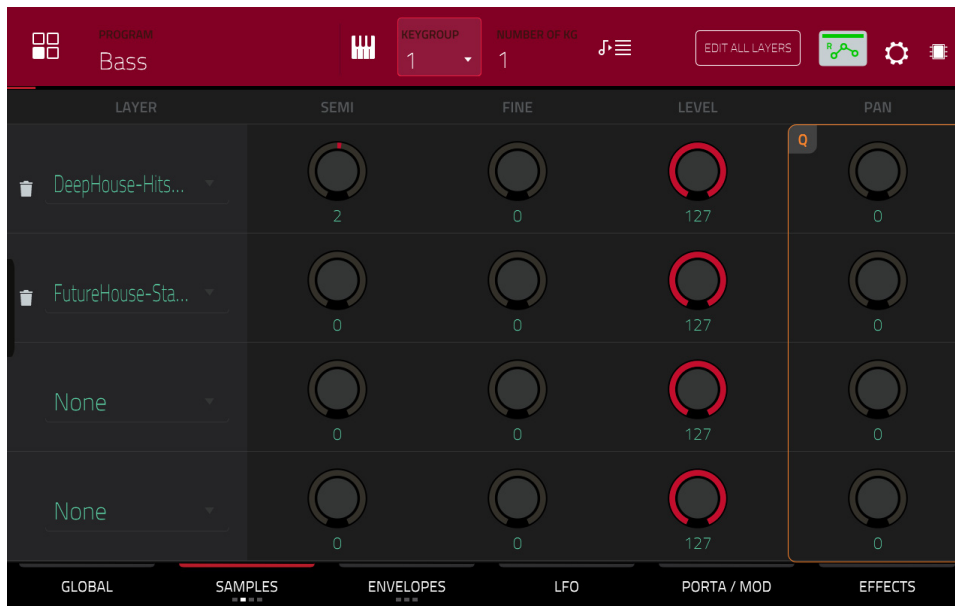

**Semi** lets you transpose the selected layer 36 up to semitones up or down. This will affect the length of the sample (if **Warp** is off). This is the same as the **Semi** field on the first Samples tab.

**Fine** provides fine-tuning of each layer by cents. This will affect the length of the sample (if **Warp** is off). This is the same as the **Fine** field on the first Samples tab.

**Level** lets you adjust each layer's volume, letting you control the "balance" of the samples assigned to the pad.

**Pan** lets you adjust the stereo placement of the respective layer.

The **third Samples** tab contains the control for its offset, velocity range and root note.

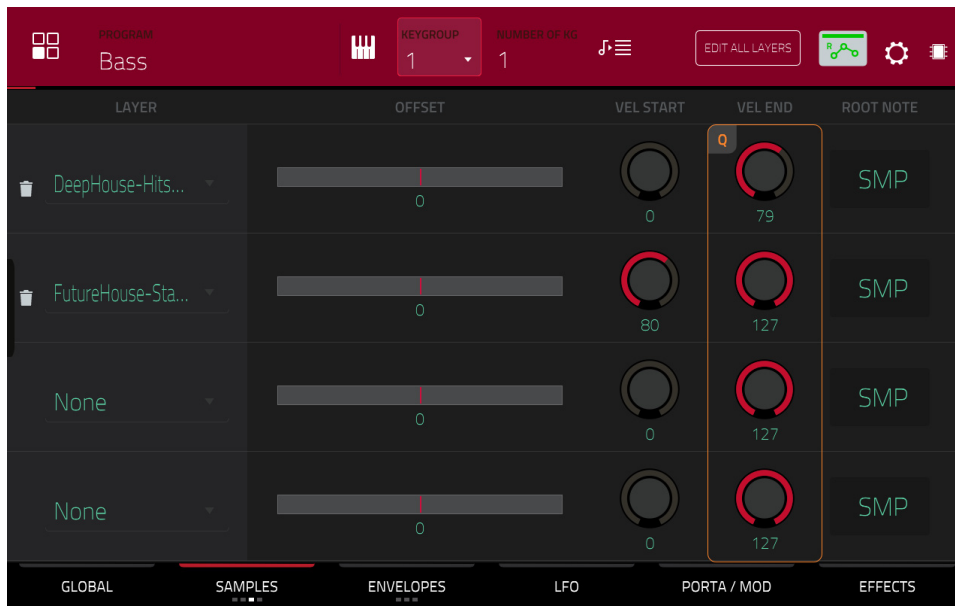

Use the **Offset** slider to determine a time offset for the sample's playback.

**Positive values** (right of center): When the pad is played, playback will start immediately but at a later point in the sample specified by the offset value.

**Negative values** (left of center): When the pad is played, playback will be delayed by the amount specified by the offset value.

Use the **Vel Start** and **Vel End** knobs to define the velocity range of each layer.

A range from **0** to **127** lets the layer respond to the entire velocity range which is input from the respective pad while, for example, a range from **100** to **127** lets the layer respond only to higher velocity levels. By assigning several samples of one instrument, you can create a realistic-sounding "multi-sample" by adjusting the velocity ranges of each layer accordingly.

For example, you may have three samples of a piano key with low force, medium force, and high force. You can set each sample to a layer and set the Velocity ranges so only low velocities trigger the low-force sample, only mid-range velocities trigger the medium-force sample, and only high velocities trigger the high-force sample.

Use the **Root Note** menu to set the starting note of each loaded sample. **Smp** denotes the sample's default pitch.

The **fourth Samples** tab contains the controls for adding randomization to sample parameters such as pitch, level and panning.



Use the **Pitch** knobs to adjust the amount of randomization applied to each sample layer's pitch.

Use the **Level** knobs to adjust the amount of randomization applied to each sample layer's volume.

Use the **Pan** knobs to adjust the amount of randomization applied to each sample layer's stereo placement.

Use the **Offset** sliders to adjust the amount of randomization applied to each sample layer's time offset.

The **All Layers** section will apply randomization to all sample layers for the following envelope parameters: **Attack**, **Decay**, **Cutoff** and **Resonance**. Use the **Depth** slider to control the amount of envelope randomization applied overall.

## Envelopes

Tap **Envelopes** to cycle through its three available tabs.

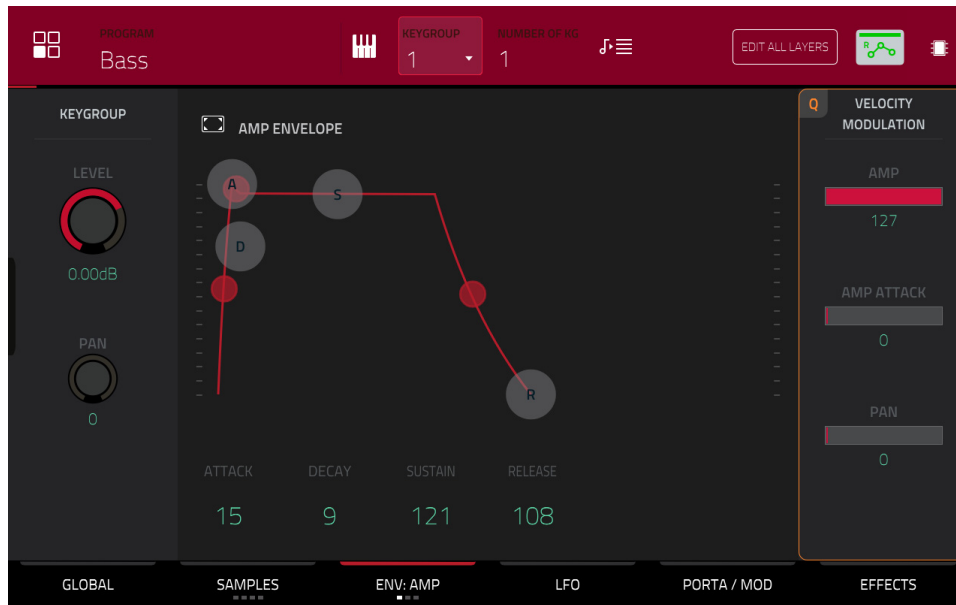

The **first Envelope** tab contains the amplitude modulation envelope.

**Keygroup Level** controls the overall volume level of the loaded sample/samples.

**Keygroup Pan** controls the overall panning of the loaded sample/samples in the stereo field.

The **Amp Envelope** controls affect level changes over time. Use the fields or tap and drag the “handles” of the envelope to shape the envelope or time-variant modulation output. Adjust the envelope’s influence on the filter frequency with the **Env** knob. See the later [Anatomy of an Envelope](#) section to learn about the envelope parameters.

The **Velocity Modulation** controls determine how much the velocity affects the volume level of the amplitude envelope (**Amp**), the attack of the amplitude envelope (**Amp Attack**), and/or the panning of the sound (**Pan**).

When you press a pad softly, only minimal modulation is applied. When you press it harder, the modulation amount also gets stronger depending on the setting of the corresponding slider.

The **second Envelope** tab contains the filter modulation envelope.

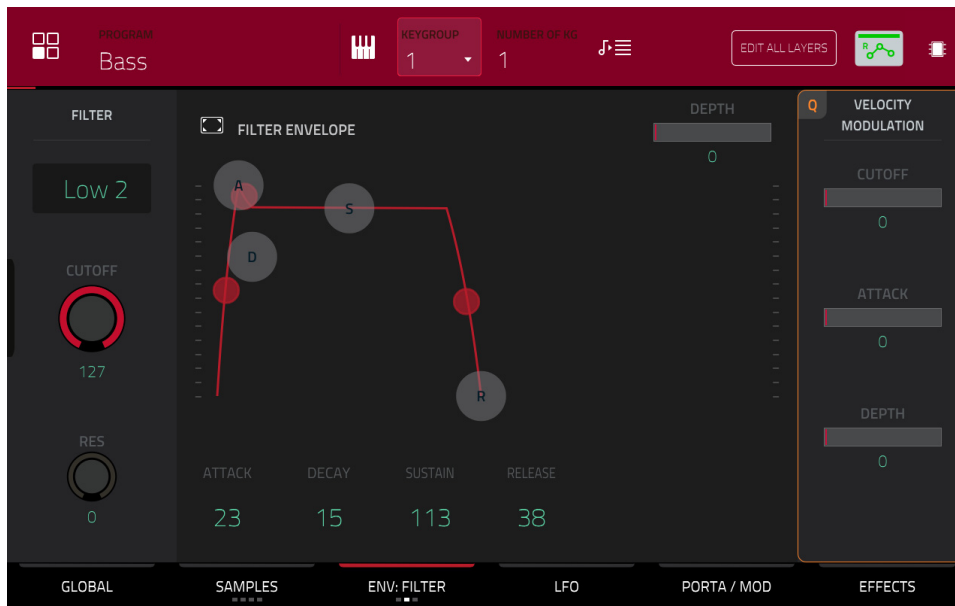

Use the **Type** field to select a filter for the selected pad. See [Appendix > Glossary > Filter](#) for an explanation of the available filter types.

Use the **Cutoff** knob to set the cutoff frequency for low-pass and high-pass filter types or the center frequency for band-pass and band-stop filter types.

Use the **Res** knob to set the resonance/emphasis of the frequencies around the cutoff point.

**Tip:** Use values lower than **80** to give more brilliance to the sound. At values higher than **80**, the sound will result in a strong audible boost around the cutoff frequency.

The **Filter Envelope** controls affect the filter frequency. Use the fields or tap and drag the “handles” of the envelope to shape the envelope or time-variant modulation output. Adjust the envelope’s influence on the filter frequency with the **Depth** knob. See the later [Anatomy of an Envelope](#) section to learn about the envelope parameters.

Use the **Depth** slider to determine the amount of influence the filter envelope has on the cutoff frequency. Higher settings will increase the modulation of the filter by the envelope; lower settings will result in only subtle changes of the filter **Cutoff** over time.

**Tip:** To give a sound a more distinctive attack, increase the **Depth** setting and set low **Attack** and **Decay** values as well as a medium-low **Sustain** value of the **Filter Envelope**. This will start a sound with the filter opened and close it shortly afterward, giving it a bright start followed by a darker sustain. String sounds, on the other hand, can sound much more “alive” with low **Depth** settings and a high **Attack** value, resulting in a slight fade-in of the higher frequencies.

The **Velocity Modulation** controls determine how much the velocity affects the cutoff frequency of the filter envelope (**Cutoff**), the attack phase of the filter envelope (**Attack**), and/or depth of influence the filter envelope has on the cutoff frequency (**Depth**).

When you press a pad softly, only minimal modulation is applied. When you press it harder, the modulation amount also gets stronger depending on the setting of the corresponding slider.

The **third Envelope** tab contains the pitch modulation envelope.

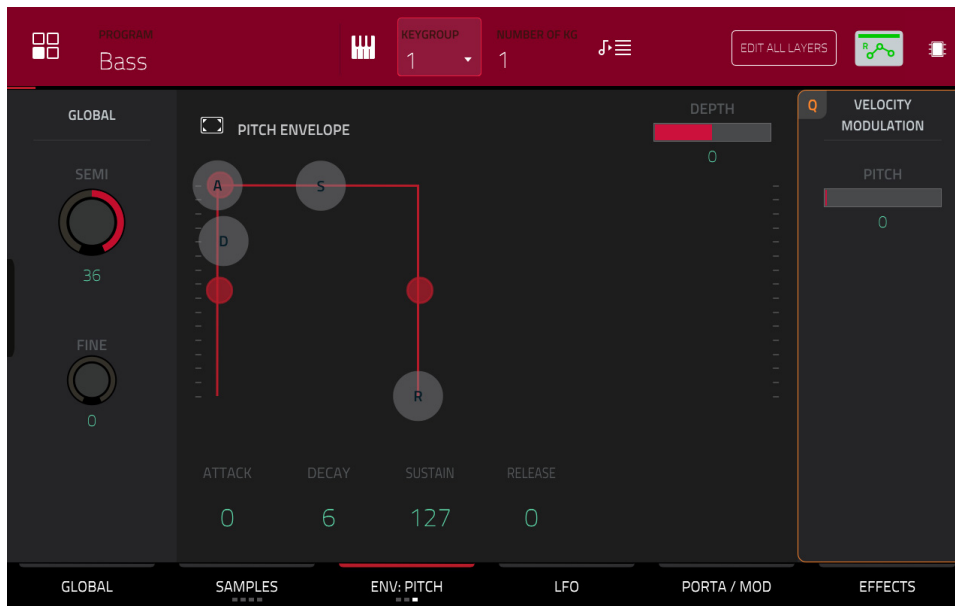

**Global Semi** lets you transpose the keygroup up to 36 semitones up or down. This will affect the length of the sample (if **Warp** is off). This is the same as the **Semi** field on the **Global** tab.

**Fine** provides fine-tuning of each layer by cents. This will affect the length of the sample (if **Warp** is off). This is the same as the **Fine** field on the **Global** tab.

The **Pitch Envelope** controls affect the keygroups's pitch change over time. Use the fields or tap and drag the "handles" of the envelope to shape the envelope or time-variant modulation output. Adjust the envelope's influence on the pitch with the **Depth** slider. See the later [Anatomy of an Envelope](#) section to learn about the envelope parameters.

The **Velocity Modulation** control determines how much the velocity affects the pitch envelope (**Pitch**).

When you press a pad softly, only minimal modulation is applied. When you press it harder, the modulation amount also gets stronger depending on the setting of the **Pitch** slider.



## LFO

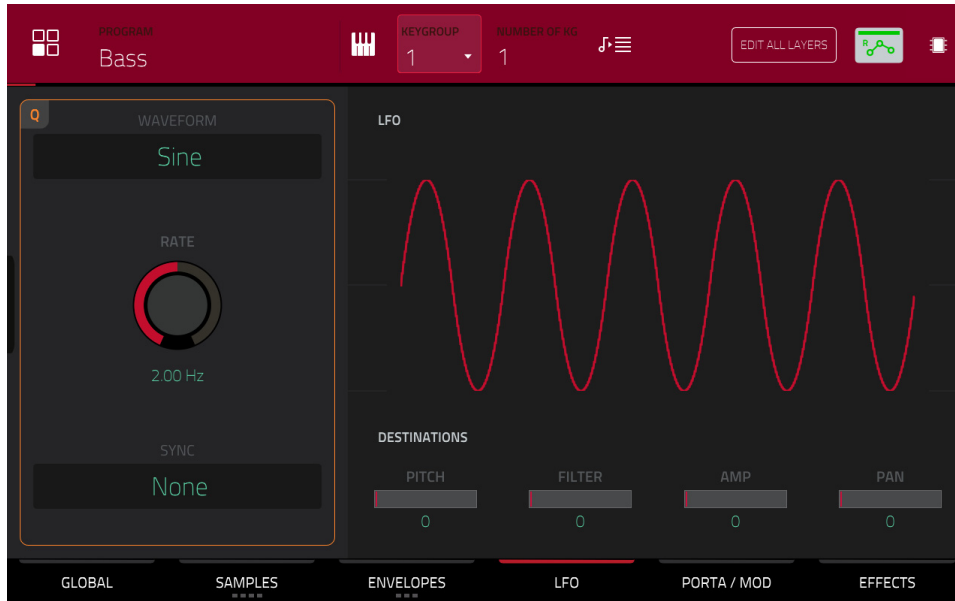

A low-frequency oscillator (LFO) generates a periodic waveform with an adjustable frequency and shape which can be used for modulation purposes.

Use the **Wave** field to select the LFO waveform type:

- Sine** (best suited for smooth modulations)
- Triangle** (best suited for smooth modulations)
- S&H** (samples a random value and holds it until the next value is generated)
- Saw** (can generate interesting filter or volume changes)
- Saw Down** (can generate interesting filter or volume changes)
- Square** (interesting results with hard-panning modulations)
- Noise** (generates random values and glides)

Use the **Rate** field to determine the LFO frequency. At lower values, it might take some time for the LFO to complete a cycle, while higher values will come closer to audible range.

Use the **Sync** field to set if the LFO's rate is synchronized with the tempo. You can select one of several time divisions (a **.** indicates a dotted note; a **T** indicates a triplet-based time division). When **None** is selected, **Sync** is off.

Use the **Destinations** sliders to determine how much the LFO affects the pitch of the sound (**Pitch**), the cutoff frequency of the filter (**Filter**), the volume level of the sound (**Amp**) and panning of the sound (**Pan**).

## Porta / Mod

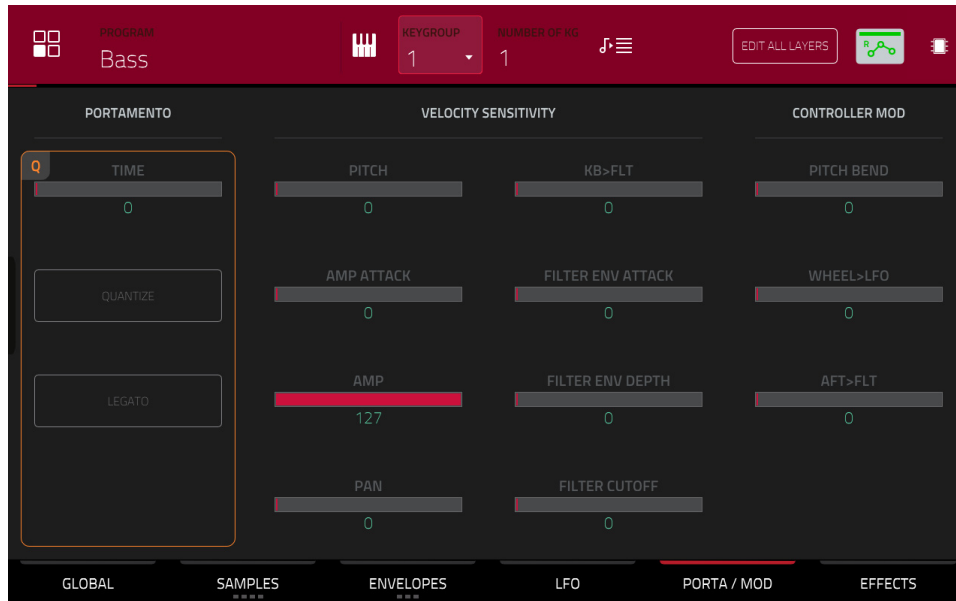

Use the **Portamento** fields to adjust the settings for pitch gliding.

The **Time** slider sets the length of the glide between notes.

Tap the **Quantize** button to synchronize the portamento time with the project tempo.

Tap the **Legato** button to enable or disable pitch gliding for all triggered notes or just legato notes.

Use the **Velocity Sensitivity** sliders to set how much velocity is required to modulate certain other parameters:

- **Pitch** enables velocity information to control the pitch of the sample.
- **Amp Attack** sets how much velocity is needed (for a triggered pad) to modulate the Attack phase for the Amp envelope.
- **Amp** enables velocity information to control the overall amplitude (level) of the sample.
- **Pan** enables velocity information to control the stereo panning of the sample.
- **KB>FLT** sets how much the note value will be added to the filter cutoff. This allows samples to sound brighter as they are played higher on the keyboard.
- **Filter Env Attack** sets how much velocity is needed (for a triggered pad) to modulate the Attack phase for the Filter envelope.
- **Filter Env Depth** enables velocity information to control the amount of the filter envelope's effect on the cutoff frequency.
- **Filter Cutoff** uses the velocity of a pad to modulate the cutoff frequency directly.

The **Controller Mod** section determines the influence of additional play controllers on various sound parameters.

**Important:** To use these parameters, make sure that a connected MIDI device can send pitch bend messages as well as aftertouch and modulation wheel data.

**Pitch Bend** sets the range (in semitones) of a connected MIDI keyboard's pitch-bend wheel.

**Wheel>LFO** determines how much a connected MIDI keyboard's modulation wheel affects the LFO intensity.

**Aft>Filt** (Aftertouch▶Filter Cutoff) determines how much a connected MIDI keyboard's aftertouch data affects the filter cutoff.

## Effects

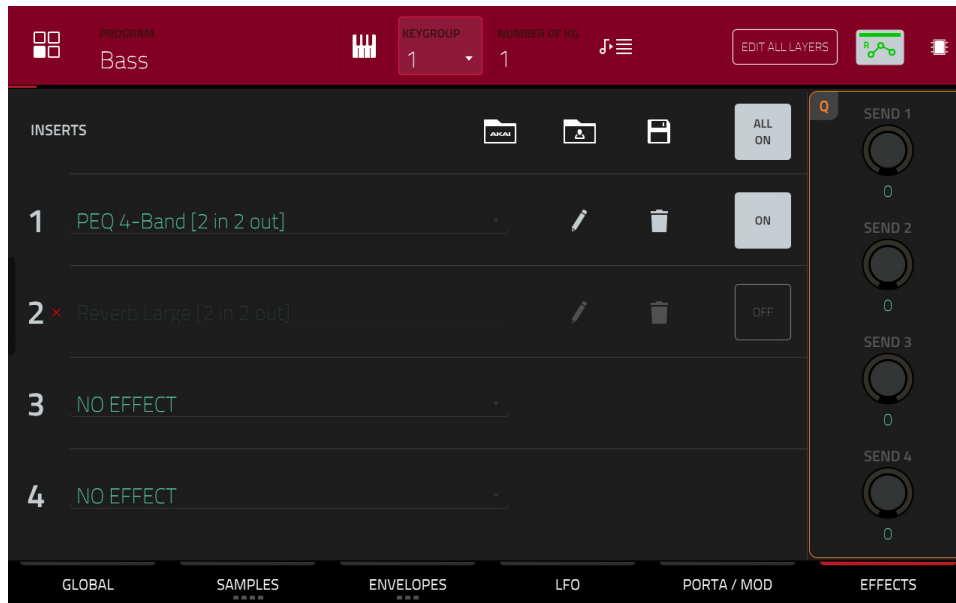

### Inserts

You can select up to four insert effects for each keygroup. To learn how to use insert effects, please see [General Features > Effects > Insert Effects](#).

**Important:** When using keygroup insert effects, they will be applied to that keygroup only. Keep this in mind if you load insert effects to multiple keygroups with overlapping note ranges—the effects will overlap in that range as well.

#### To add an effect:

1. Double-tap the desired **Inserts** slot. A list of effects will appear.
2. Swipe up or down to move through the list.  
You can tap the **Type** and **Manufacturer** buttons to sort your effects by those categories.
3. **To load an effect**, double-tap it, or tap **Select**.  
**To close the list**, tap **Close**.

**To remove an effect from its slot**, tap the **trash can icon**.

**To enable or disable the effect**, tap the **On/Off** button for the slot.

**To enable or disable all four insert effects**, tap the **All On/Off** button in the upper-right corner.

**To load a factory FX rack**, tap the **Akai folder** icon. You can choose from a number of preset combinations of insert effects by applications like Drums and Percussion, Voice, LoFi, Mastering, and more.

**To load a saved FX rack**, tap second **folder** icon.

**To save an FX rack**, tap the **disk** icon.

To adjust the effect's parameters, tap the **pencil icon**. Use the **user interface** or **sliders** to set the value of each parameter. These values affect only this instance of the effect; insert effects are not global.

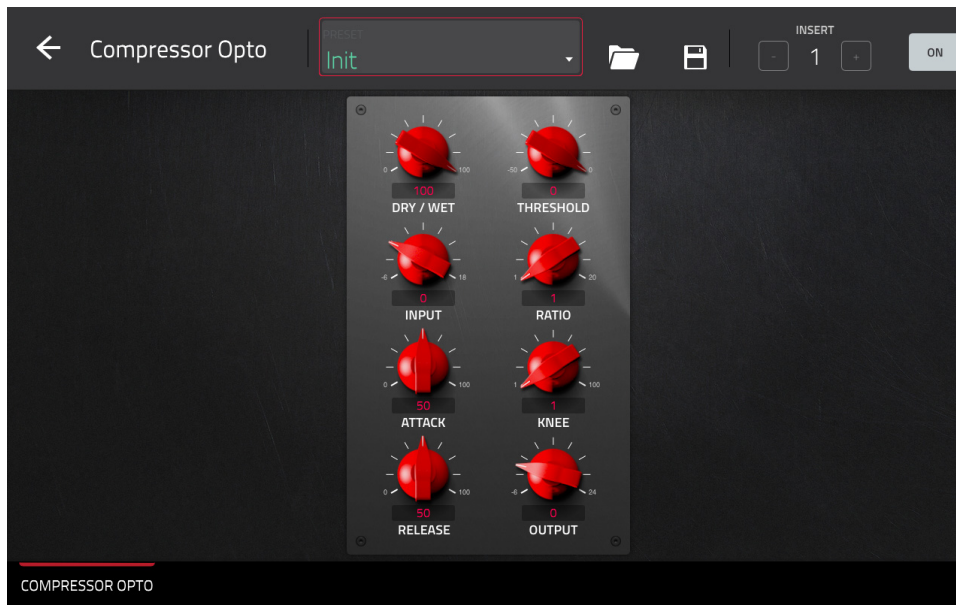

## Sends

The audio of the program will be routed to send effects (if you have any loaded) at their designated send levels. The return channels will then send the audio to an assigned main output at the designated return levels.

Use the **Send** knobs to set the volume level of the signal the program will route to each send effect.

You can select up to four send effects for each keygroup, but remember that they will be applied to that keygroup only. Keep this in mind if you load insert effects to multiple keygroups with overlapping note ranges—the effects will overlap in that range as well.

**Important:** To use a send effect, you have to load an effect into the corresponding send effect slot in the Channel Mixer. See [Channel Mixer > Returns](#) to learn more how to do this. To learn about send effects, please see [General Features > Effects > Send/Return Effects](#).

## Clip Programs

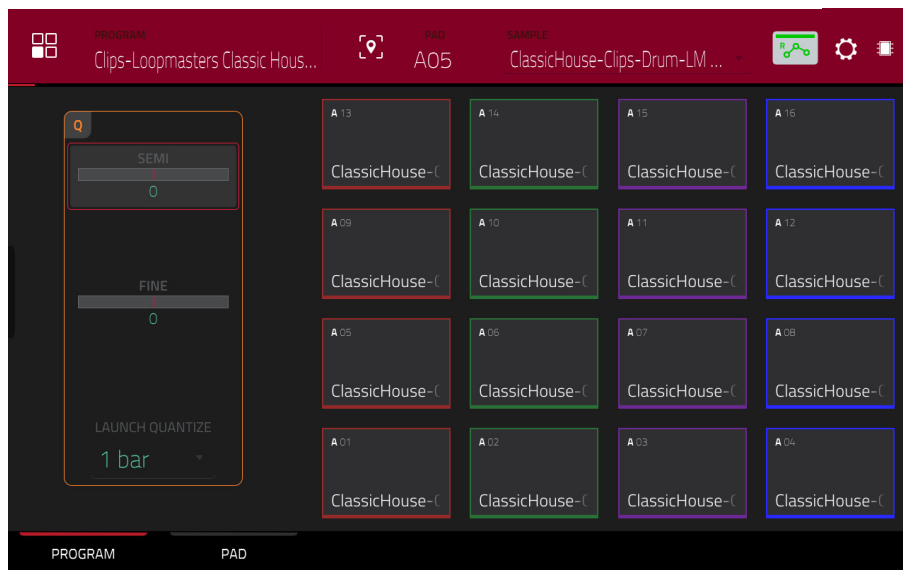

When using clip programs, Program Edit Mode lets you assign a sample (a loop called a **clip**) to each pad in a single bank. You can also edit various settings to determine how each pad launches its assigned clip.

**To select a pad**, press it. Its parameters will appear on the screen immediately.

**To view a specific tab of parameters**, tap **Program** or **Pad** the bottom of the screen. The **Program** tab is where you assign clips to pads (see [Program](#) below). The **Pad** tab is where you determine how each pad plays its clip (see [Pad](#) below).

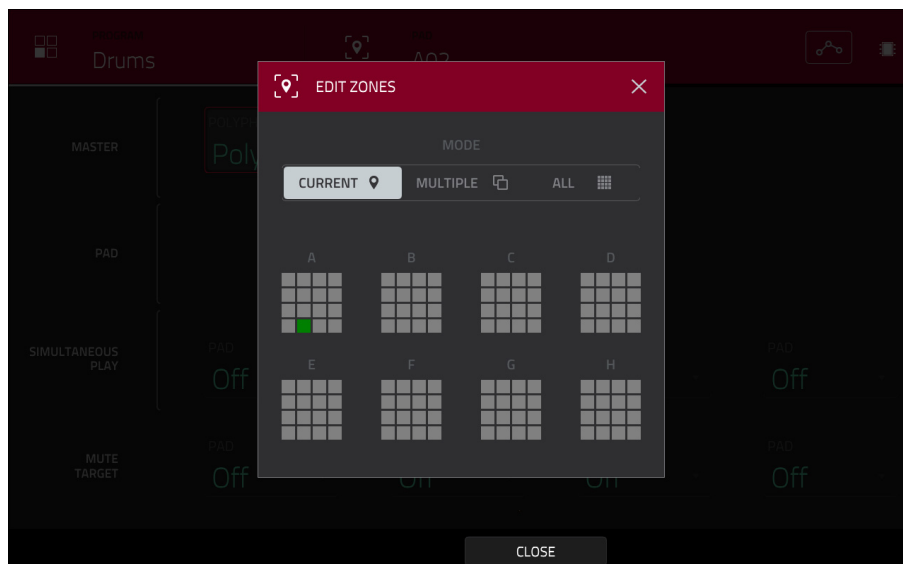

Tap the **location icon** at the top of the screen (between the **Program** and **Pad** fields) to open the **Edit Zones** window, which is a feature for drum programs and clip programs. This window displays an overview of any selected pads. Use the **Mode** selector to set how the selected pads will be edited:

**Current:** Only the currently selected pad can be edited.

**Multiple:** All selected pads can be edited simultaneously.

**All:** All pads can be edited simultaneously.

**To close the window**, tap **Close**, the **X**, or anywhere outside the window.

The automation button indicates the global automation state. This is shown in several modes. See [General Features > Automation](#) to learn about this.

The Settings window lets you configure certain Audio Edit Mode settings.

**To view the Settings**, tap the **gear icon**.

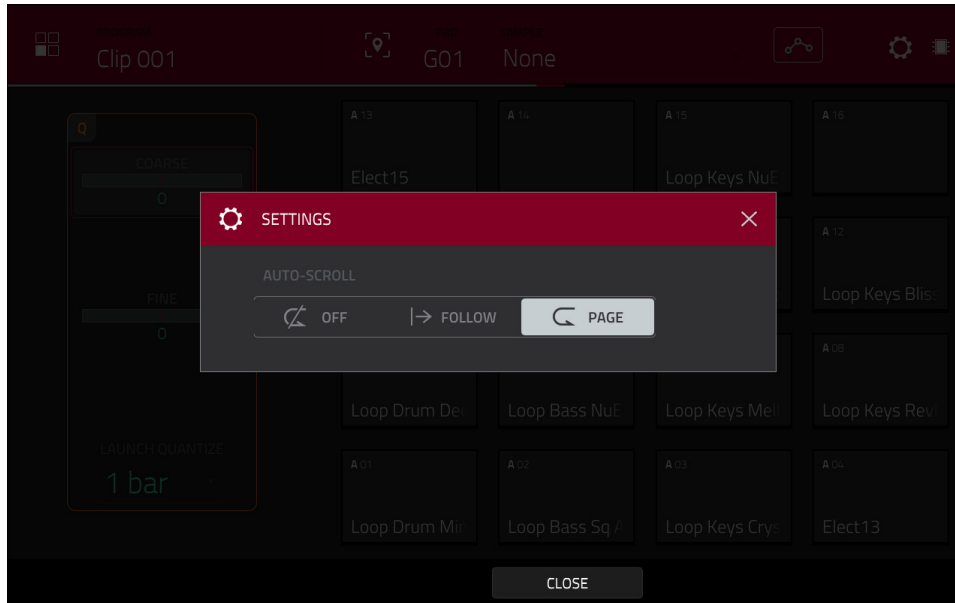

Use the **Auto-Scroll** selector to set how the screen behaves relative to the audio playhead while viewing the **Pad** tab.

**Follow:** Depending on the zoom setting, the waveform display will scroll along in the background while keeping the audio playhead centered.

**Page:** The waveform display will move to the “next page” to follow the audio playhead.

**Off:** The waveform display will not move at all.

These functions also apply to the Grid View, Audio Edit Mode, List Edit Mode, and Sample Edit Mode.

## Program

This tab is where you can assign clips to each pad and adjust the program's overall tuning and quantization.

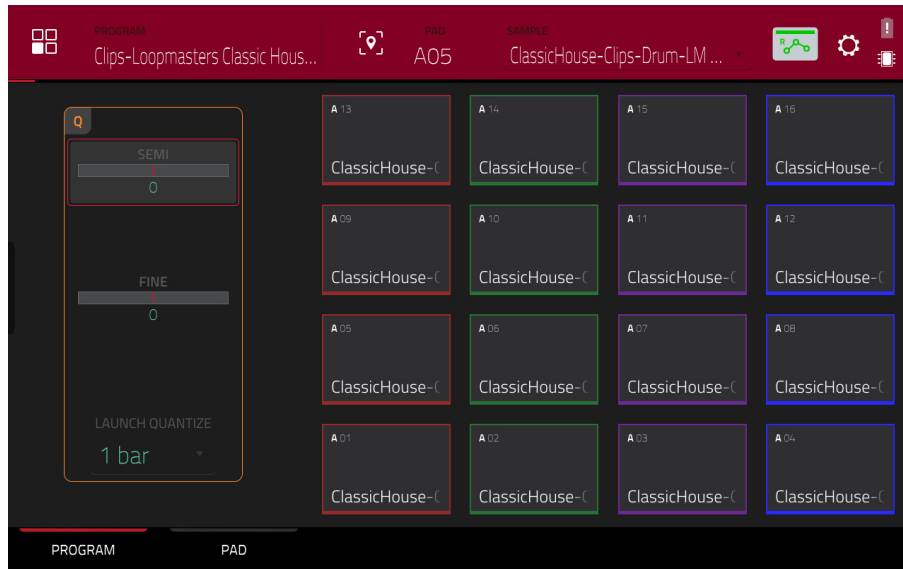

**To assign a sample to a pad**, press or tap a pad to select it (it will play its assigned samples, if any). Tap the **Sample** field, and then use the **data dial** or **-/+** buttons to select a clip. Alternatively, double-tap the **Sample** field, and then tap a clip to select it.

**To clear the assigned clip from a selected pad**, assign a sample to a pad, but select **None**.

**Coarse** lets you transpose the program up to 36 semitones up or down.

**Fine** provides fine-tuning of the program up to 99 cents up or down.

Use the **Launch Quantize** field to set the quantization of the program in bars (or subdivisions of a bar).

## Pad

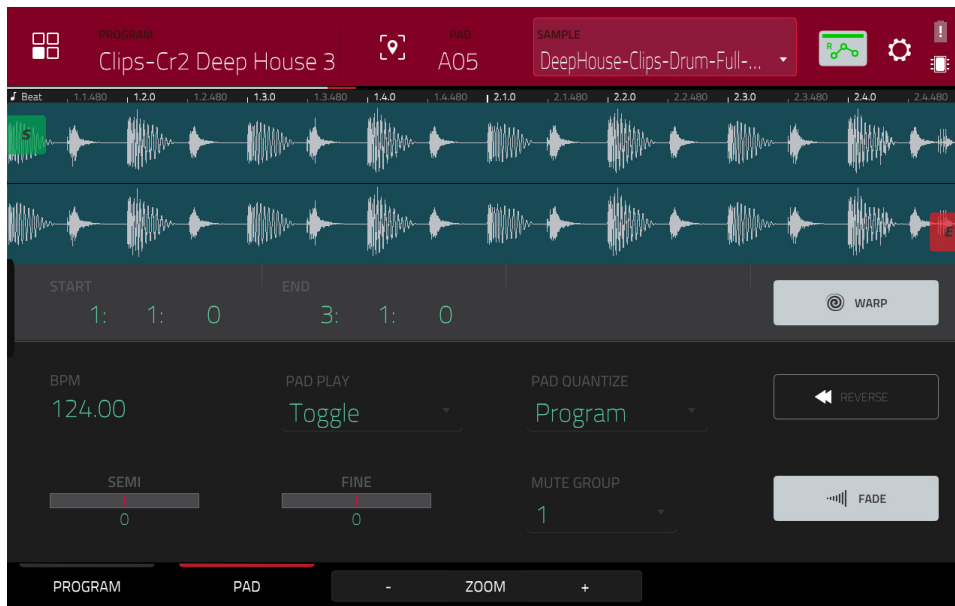

The upper half of the screen shows the clip waveform. The lower half shows the editing controls.

The waveform display shows the “active” section of the clip waveform. Swipe left or right on the waveform to move through it.

Above the waveform is the timeline, shown in bars, beats, and ticks.

The green marker and red marker are the start point and end point (respectively). These two points define the region of the sample that will be played.

**To move the start point or end point of the selected region**, do any of the following:

- Tap and drag the **S** or **E** marker left or right.
- Use the **Start** or **End** fields shown below the waveform.
- Use the **first** row of **Q-Link knobs (Layer 1 Start)** to adjust the start point or the **second** row of **Q-Link knobs (Layer 1 End)** to adjust the end point. The right-most **Q-Link knobs (12 and 16)** provide coarse adjustment. The left-most **Q-Link knobs (9 and 13)** provide fine adjustment.

Use the **Zoom +** or **Zoom -** buttons at the bottom of the screen to zoom in or out (respectively) of the waveform.



Below is a brief step-by-step process so you can get familiar with setting up a clip. Continue reading the rest of this chapter to learn how to use the parameters in this window.

### To assign and edit a clip:

1. Assign a sample to a pad using the **Program** tab (described [earlier](#)). For example, start with a four-bar drum loop.
2. In the **Pad** tab, note that the **BPM** field has a value, which is automatically detected.

If the **Warp** button is not already on, tap it. The Warp function keeps the loop in time with the sequence tempo or the global tempo.

3. If you need to edit the loop's tempo manually, do any of the following:
  - Tap the **BPM** field, and then use the **data dial** or **-/+** buttons to change the value.
  - Double-tap the **BPM** field, and then use the numeric keyboard that appears to enter a value.
4. Let's shorten the loop to a two-bar loop by doing any of the following:
  - Tap and drag the start point (**S**) or end point (**E**) marker.
  - Tap the **beat**, **bar**, or **tick** value of the **Start** or **End** fields, and then use the **data dial** or **-/+** buttons to change the value.
  - Double-tap the **beat**, **bar**, or **tick** value of the **Start** or **End** fields, and then use the numeric keyboard that appears to enter a value.

Set the locations properly to ensure the loop's timing is correct—neither too short nor too long. When the loop repeats, it should feel seamless.

5. If the **Fade** button is not already on, tap it. This applies a very small fade-in and fade-out at the start and end of the clip to prevent “clicks” and glitches if start point or end point is not at a “zero-crossing.”
6. If you need to edit the loop's pitch manually, do any of the following:
  - Tap the **Coarse** or **Fine** slider, and then use the **data dial** or **-/+** buttons to change the value.
  - Use **Q-Link Knobs 1** and **2** (**Layer \_\_ Semi Tune** and **Layer \_\_ Fine Tune**) to change the value of the **Coarse** or **Fine** sliders.
  - Double-tap the **Coarse** or **Fine** slider, and then use the numeric keyboard that appears to enter a value.

The **Coarse** slider adjusts the pitch in semitones. The **Fine** value adjusts the pitch in cents. You will hear the pitch adjust in real time.

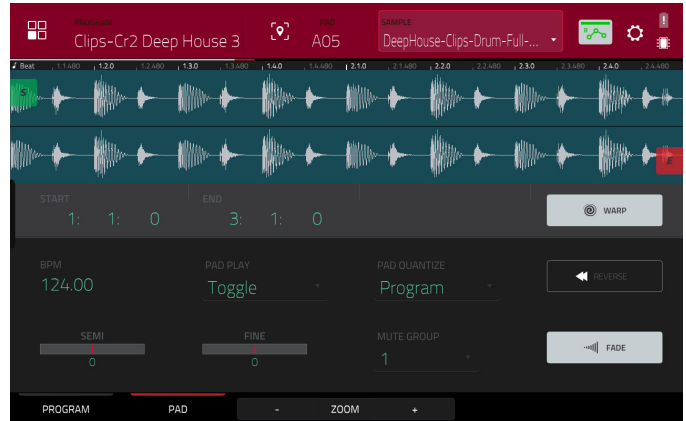

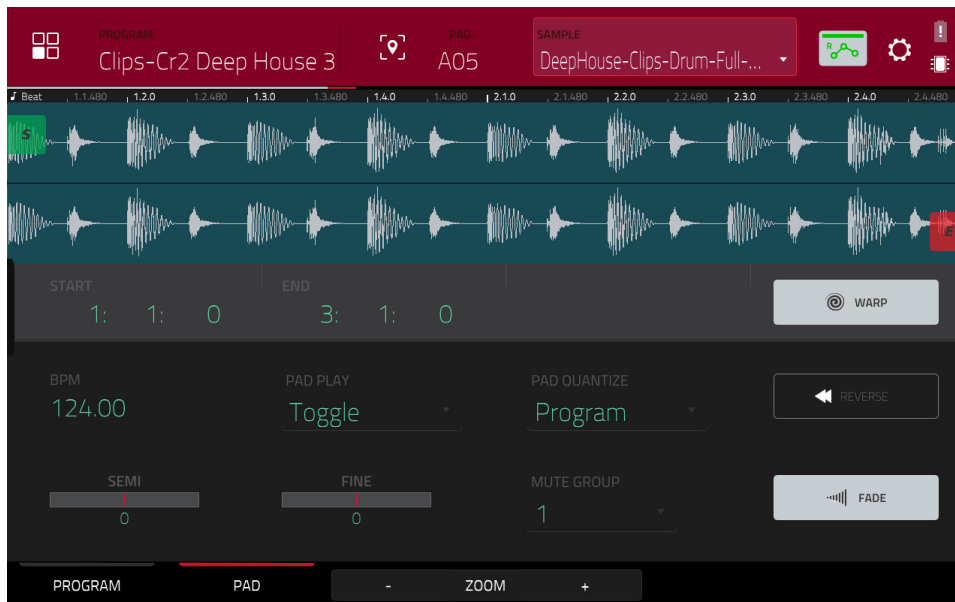

Tap **Warp** to lengthen or shorten the clip without changing its pitch, and use the **BPM** field to change the tempo. Use the **Coarse** and **Fine** sliders if you want to change the pitch.

Use the **Pad Play** field to determine how the clip is played.

**One Shot:** When you press the pad, the entire clip will play from start to end and then stop.

**Toggle:** When you press the pad, the entire clip will play from start to end and loop indefinitely. Pressing it again—or launching another in the same mute group—will stop its playback. This is the most common usage.

Use the **Pad Quantize** field to set the quantization of the pad in bars (or subdivisions of a bar). When set to **Program** so it uses the same quantization as the overall program (determined by the **Launch Quantize** field). When set to **Off**, the pad will not follow any quantization at all.

Tap **Reverse** to reverse the clip's audio.

**Coarse** lets you transpose the pad up to 36 semitones up or down.

**Fine** provides fine-tuning of the pad up to 99 cents up or down.

Use the **Mute Group** field to assign the selected pad to one of the 32 available groups. When pads assigned to the same mute group receive MIDI notes, the last pad played will silence all other pads in that mute group. A mute group affects pads within that program only; mute groups do not affect pads in other programs.

By default, each column of pads is assigned to the same mute group. This means only one pad from each column can be playing its clip at a time. You can use the **Mute Group** field to configure this any way you like, though.

Use the **Fade** button to apply a very small fade-in and fade-out at the start and end of the clip. This can help prevent “clicks” and glitches that may occur if the start point or end point is not placed at the waveform's “zero-crossings.”

## Plugin Programs

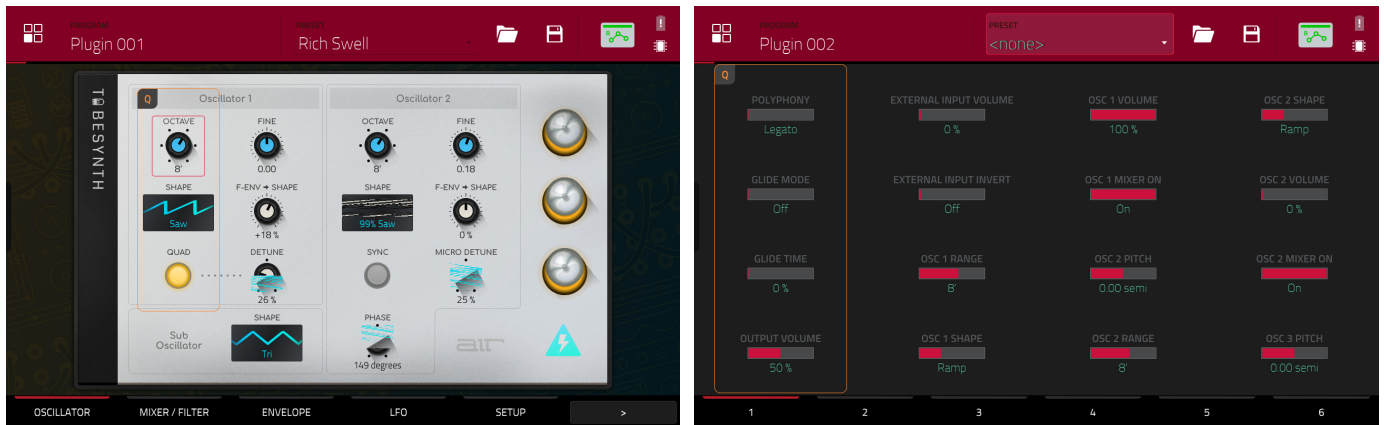

For plugin programs, you will see a graphical representation of the plugin interface, or an overview of all available plugin parameters with a slider for each.

**To select an effect preset**, use the dropdown menu at the top of the screen.

**To load a saved preset**, tap the **folder icon** at the top of the screen.

**To save a preset**, tap the **disk icon** at the top of the screen.

The automation button indicates the global automation state. This is shown in several modes. See [General Features > Automation](#) to learn about this.

Use the **user interface** or **sliders** to set the value of each parameter.

Use the **tabs** at the bottom of the screen to access the available parameters.

**To assign a parameter to one of the sliders**, use the MPC software.

**Note:** To see the user guide in the MPC software and learn how to do this, click the **Help** menu, select **MPC Help**, and select **MPC User Manual**.

## MIDI Programs

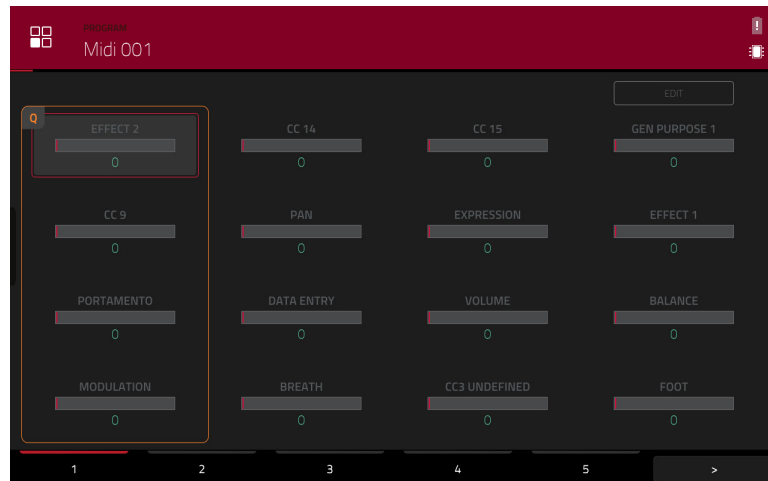

For MIDI programs, you will see an overview of all available MIDI CCs with a slider for each.

Use the **sliders** to set the value of each parameter.

Use the six **tabs** at the bottom of the screen to access the available parameters.

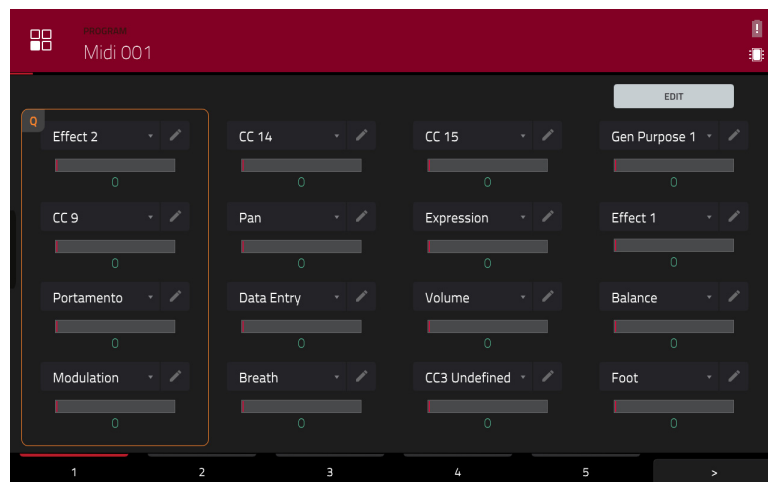

Tap the **Edit** button in the top-right of the page to edit the MIDI program assignments and naming.

**To assign a parameter**, tap the **dropdown menu** and use the **data dial** or **+/-** buttons to scroll through the available MIDI assignments. You can also double-tap the menu to view a list of assignments.

**To rename a parameter**, tap the **pencil icon** next to the dropdown menu, and then use the keyboard that appears to enter a new name. Once renamed, you can save the program and use it with other projects to retain your custom naming.

## CV Programs

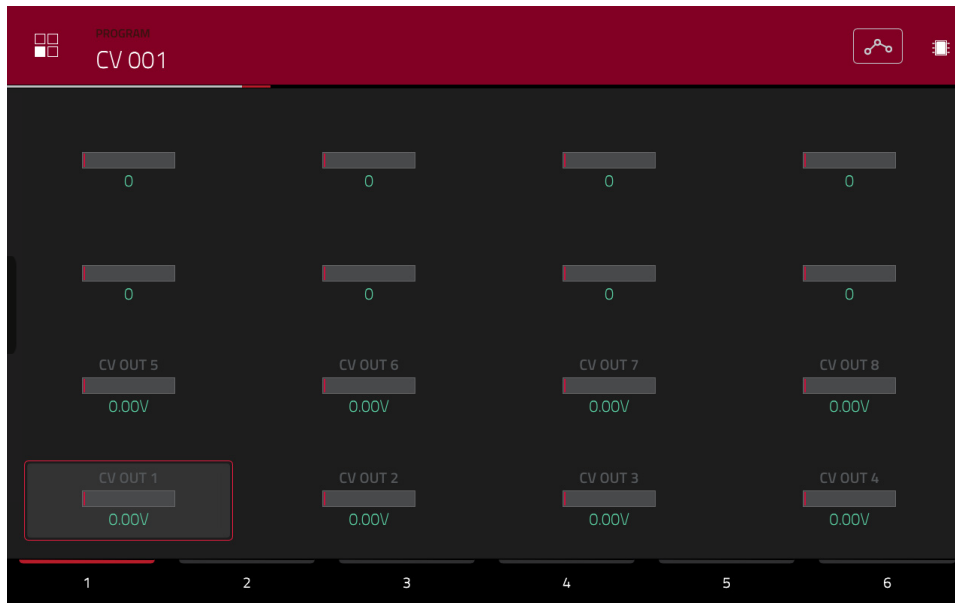

For CV programs, you will see an overview of all available CV outputs with a slider for each.

The automation button indicates the global automation state. This is shown in several modes. See [General Features > Automation](#) to learn about this.

Use the **sliders** to set the value of each parameter.

Use the six **tabs** at the bottom of the screen to access the available parameters.

**To assign a parameter to one of the sliders**, use the MPC software.

**Note:** To see user guide in the MPC software and learn how to do this, click the **Help** menu, select **MPC Help**, and select **MPC User Manual**.

## Anatomy of an Envelope

An envelope creates a variable control signal. It can be used, for instance, to modulate the filter settings of a sound over a given period of time.

For drum programs, use the **AD/AHDS** selector to select an AD or AHDS envelope. When **Sample Play** is set to **Note-On**, it will use an ADSR envelope.

Keygroup programs always use **AHDS** envelopes. When **Sample Play** is set to **Note-On**, it will use an **ADSR** envelope.

With **AHDS** envelopes, the following happens when you trigger a sample:

1. Within the period of time you have defined with the attack (**Atk**), the sample volume rises to its maximum value.
2. The sample's maximum volume will be maintained during the **Hold** phase.
3. During the **Decay** phase, the sample's volume will gradually drop to the sustain level.
4. The sample's volume will stay at the sustain level (**Sust**) until the pad is released.

Use the **A Shape** and **D Shape** fields to adjust the curve of the **Attack** and **Decay** phases, respectively.

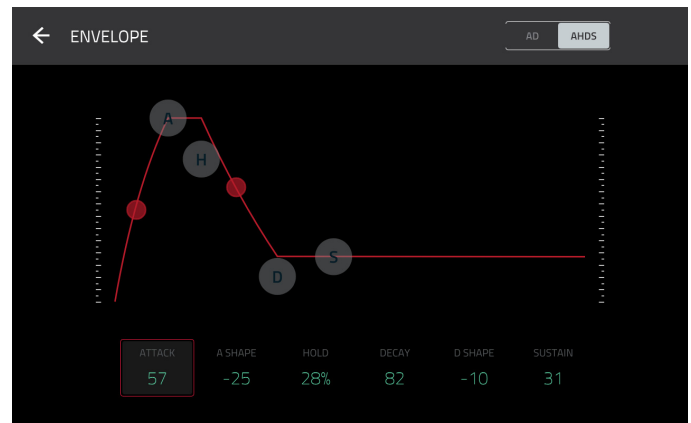

With **AD** envelopes, the following happens when you trigger a sample:

1. Within the period of time you have defined with the attack (**Atk**), the sample volume rises to its maximum value.
2. The sample's maximum volume will be maintained until its **Decay** phase, when the sample's volume will gradually drop to zero over the set duration. Click the **Type** drop-down menu to select how the decay functions:

**Decay From Start:** The volume will start decreasing immediately after reaching its maximum level.

**Decay From End:** The maximum volume will be maintained for a hold phase until it reaches the decay phase.

Use the **A Shape** and **D Shape** fields to adjust the curve of the **Attack** and **Decay** phases, respectively.

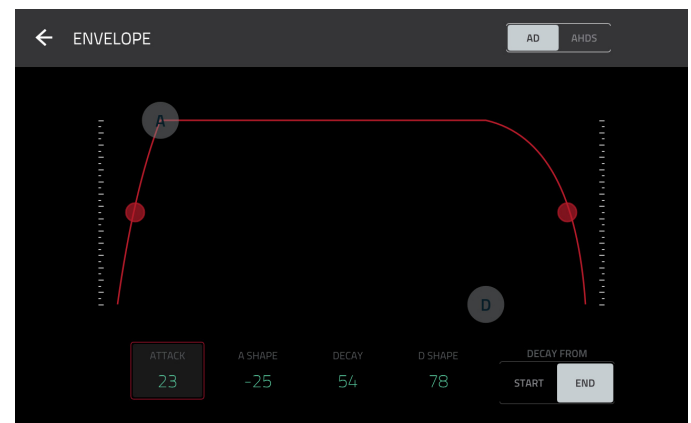

With **ADSR** envelopes, the following happens when you trigger a sample:

1. Within the period of time defined by **Attack**, the sample volume rises to its maximum value.
2. During the **Decay** phase, the sample's volume will gradually drop to the **Sustain** level.
3. The sample's volume will stay at the **Sustain** level until the **Release** phase begins.
4. The sample's volume will drop to "zero" over the duration set by **Release**.

Use the **A Shape**, **D Shape** and **R Shape** fields to adjust the curve of the **Attack**, **Decay** and **Release** phases, respectively.

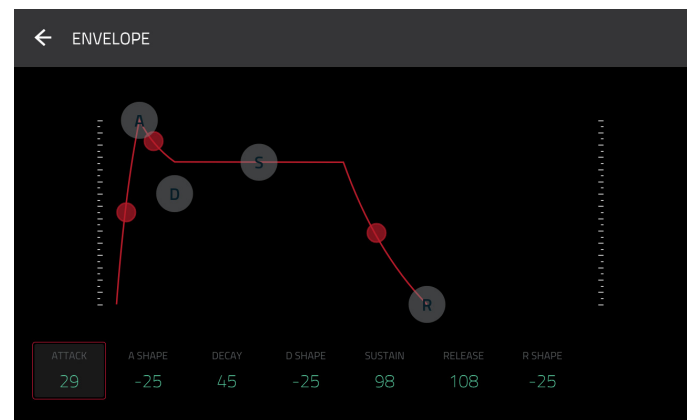

## List Edit Mode

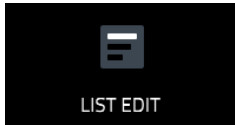

List Edit Mode has some of the features of the Grid View—as well as some additional ones—but with a different interface/workflow.

| #  | TIME      | PAD/NOTE   | LENGTH | VELOCITY | MOD TYPE   | VALUE | PROB | RAT |
|----|-----------|------------|--------|----------|------------|-------|------|-----|
| 1  | 001:01:00 | Expression |        |          | Expression | 127   |      |     |
| 2  | 001:01:00 | A03 (42)   |        |          | Pad Mute   | Off   | On   |     |
| 3  | 001:01:00 |            |        |          | Pan        | 50R   |      |     |
| 4  | 001:01:00 | A01 (37)   | 23     | 127      | -          |       | 100% | -   |
| 5  | 001:01:00 | A12 (43)   | 23     | 127      | -          |       | 100% | -   |
| 6  | 001:01:00 | A13 (49)   | 23     | 127      | -          |       | 100% | -   |
| 7  | 001:01:24 | A07 (46)   | 23     | 36       | -          |       | 100% | -   |
| 8  | 001:01:48 |            |        |          | Pan        | 50R   |      |     |
| 9  | 001:01:48 | A05 (40)   | 23     | 91       | -          |       | 100% | -   |
| 10 | 001:01:72 | A06 (38)   | 23     | 61       | -          |       | 100% | -   |

The time counter at the top of the screen indicates the current playhead position. This is shown in most of the modes. See [General Features > Time Counter/Locate](#) to learn about this.

The clock icon at the top of the screen opens the **Timing Correct** window. See [General Features > Timing Correct \(TC\)](#) to learn about this.

The **View** menu lets you select what type of events are shown in the list.

**All:** Select this option to show all event types.

**Notes:** Select this option to show only notes.

**Aftertouch:** Select this option to show only aftertouch messages.

**Track Automation:** Select this option to show only track automation events.

**Program Automation:** Select this option to show only program automation events.

**Pitch Bend:** Select this option to show only pitch bend events.

**Control Change:** Select this option to show only MIDI CC messages.

**Program Change:** Select this option to show only MIDI program change messages.

**Ch Pressure:** Select this option to show only channel pressure messages.

**Solo/Mute:** Select this option to show only solo and mute events for tracks, programs, and pads.

**Other:** Select this option to show other types of events not listed above, such as pad or keygroup parameters.

The automation button indicates the global automation state. This is shown in several modes. See [General Features > Automation](#) to learn about this.

The **Settings** window lets you configure certain List Edit Mode settings.

To view the **Settings**, tap the gear icon.

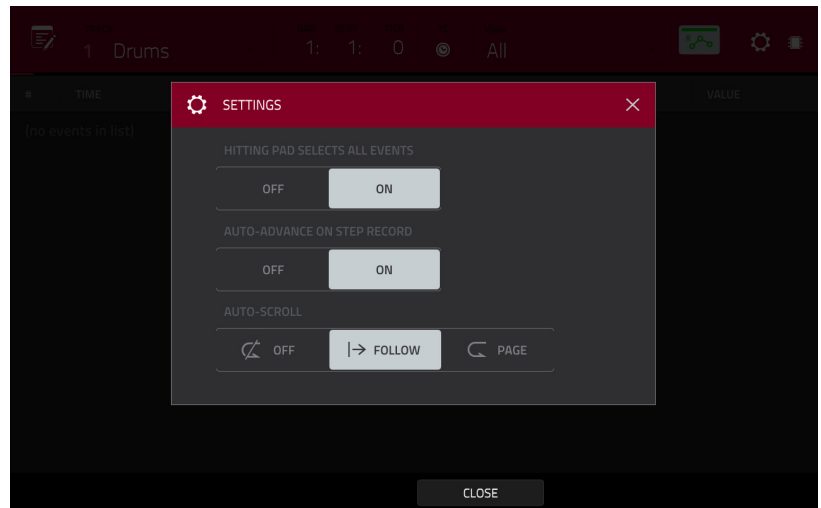

Use the **Hitting Pad Selects All Events** selector to turn the feature on or off. When **On**, pressing a pad will automatically select all note events for that pad in the sequence on that track. When set to **Off**, pressing a pad will simply play its sound without selecting any note events.

Use the **Auto-Advance on Step Record** selector to turn the feature on or off. When set to **On**, pressing a pad when the track is record-armed will move the audio playhead forward by a length determined by the current **Time Division** setting in the **TC/Timing Correct** window. When set to **Off**, pressing a pad when the track is record-armed will not change the audio playhead position.

Use the **Auto-Scroll** selector to set how the screen behaves relative to the audio playhead.

**Follow:** The list will scroll along in the background while keeping the audio playhead centered.

**Page:** The list will move to the “next page” to follow the audio playhead.

**Off:** The list will not move at all.

These functions also apply to the Grid View, Audio Edit Mode, and Sample Edit Mode.

| # | TIME | PAD/NOTE | LENGTH | VELOCITY | MOD TYPE | VALUE |
|---|------|----------|--------|----------|----------|-------|
|---|------|----------|--------|----------|----------|-------|

The sequence for the track will be shown as a list of events, with the following parameters:

**#:** This is the number of the note event.

**Time:** This is the position of the note event in bars, beats, and ticks. If multiple note events occur at the same time, additional note events will be listed immediately below, but their **Time** values will be grayed out.

**Event Type:** This icon indicates the type of event (e.g., **Note**, **Aftertouch**, **Track Automation**, etc.). See the list of icons below showing the different types of events.

**Pad/Note:** This is the pad and/or corresponding MIDI note number. For drum programs, you will see the pad number. For keygroup programs, plugin programs, and midi programs, you will see the note.

**Length:** This is the length of the note event in ticks.

**Velocity:** This is the velocity of the note event with its corresponding color.

**Mod Type:** This is the type of modifier used on the note event via automation.

**Value:** This is the value of the modifier automation.



| #  | TIME      | PAD/NOTE | LENGTH | VELOCITY | MOD TYPE   | VALUE | PROB | RAT |
|----|-----------|----------|--------|----------|------------|-------|------|-----|
| 1  | 001:01:00 |          |        |          | Expression | 127   |      |     |
| 2  | 001:01:00 | A03 (42) |        |          | Pad Mute   | Off   | On   |     |
| 3  | 001:01:00 |          |        |          | Pan        | 50R   |      |     |
| 4  | 001:01:00 | A01 (37) | 23     | 127      | -          |       | 100% | -   |
| 5  | 001:01:00 | A12 (43) | 23     | 127      | -          |       | 100% | -   |
| 6  | 001:01:00 | A13 (49) | 23     | 127      | -          |       | 100% | -   |
| 7  | 001:01:24 | A07 (46) | 23     | 36       | -          |       | 100% | -   |
| 8  | 001:01:48 |          |        |          | Pan        | 50R   |      |     |
| 9  | 001:01:48 | A05 (40) | 23     | 91       | -          |       | 100% | -   |
| 10 | 001:01:72 | A06 (38) | 23     | 61       | -          |       | 100% | -   |

The **red arrow** (▶) on the left side of the list represents the audio playhead's current position. If your sequence is playing, the arrow will move accordingly.

The following icons indicate the corresponding types of events:



**Note**



**Track Mixer Automation (Volume, Pan, Mute, Solo)**



**Track MIDI CC Automation (0–127)**



**Track Parameter Automation (Aftertouch, Pitchbend, Channel Pressure, or Program Change)**



**Program Mixer Automation (Volume, Pan, Mute, Solo, or Send 1–4)**



**Program Parameter Automation (options vary based on the type of program)**



**Program Insert Effect Automation (options vary based on the effect)**



**Pad/Keygroup Mixer Automation (Level, Pan, Pad Mute, Pad Solo, or Send 1–4)**



**Pad/Keygroup Parameter Automation (options vary based on the type of program)**



**Pad/Keygroup Insert Effect Automation (options vary based on the effect)**

**To select an event**, tap it.

**To select multiple events**, press and hold **Shift** and tap each event.

**To insert a note event**, press **Rec** or **Overdub** so the button is lit, and then press a **pad**. A note event will be created at the current location using the pad you pressed. You can keep pressing additional pads, which will continue to insert each press as a single note event in the order you pressed them (similar to a step sequencer). Press **Stop** to exit this function.

**Note:** Depending on the **Auto-Advance on Step Record** setting, the current time position will either advance each time you press a pad or remain in place. See the earlier description of **Auto-Advance on Step Record** to learn about this.

Alternatively, tap **Insert** at the bottom of the screen to open the Insert Event window. Use the **Time Counter** fields to set the location of the event. Use the **Type** field to set the type of event. Use the **Pad** field to set the pad where the note event will be created.

**To edit the Pad/Note, Length, or Velocity or numeric Value of an event**, tap the value to select it, and then use the **data dial** or **-/+** buttons to change the value. Alternatively, double-tap it and use the numeric keypad that appears to enter a value (for **Length**, **Velocity**, or numeric **Value** only).

**To edit the Length of an event according to your Timing Correct settings**, tap the value to select it, and then press and hold **Shift** and use the **data dial** or **-/+** buttons to change the value.

**To shift the Pad/Note of an event by pad bank**, tap the value to select it, and then press and hold **Shift** and use the **data dial** or **-/+** buttons to change the pad bank.

**To turn a Solo/Mute event on or off**, tap the desired setting on the **On/Off** switch. Alternatively, tap the **On/Off** switch to select it, and then use the **data dial** or **-/+** buttons to change the value.

**To move an event**, tap it to select it, tap **Nudge** at the bottom of the screen, and then use the **data dial** or **-/+** buttons to shift the event up or down. Repeat this for other events, or tap **Nudge** again to turn the feature off.

**To move an event according to your Timing Correct settings**, tap the **Time** value to select it, and then press and hold **Shift** and use the **data dial** or **-/+** buttons to change the value.

**To play an event**, tap it to select it, and then tap **Play** (▶) at the bottom of the screen. This works with note events only.

**To delete an event**, tap it to select it, and then tap **Delete** at the bottom of the screen.

## Browser



The Browser lets you navigate your MPC hardware's internal and external hard disks to load samples, sequences, songs, etc. Using filter buttons and user-definable folders, you can easily adapt it to your preferred workflow. You can also audition (preview) your samples before loading them.

**Important:** You can install an additional SATA drive in your MPC X, MPC Live, MPC Live II, MPC Key 61, or MPC Key 37 hardware, allowing for even more storage space. See [Appendix > SATA Drive Installation](#) to learn more about this.

**Important:** MPC hardware supports read and write capability for **exFAT**, **FAT32**, **NTFS**, and **EXT4** file systems as well as read-only capability for **HFS+** file systems. We recommend using an exFAT file system as it is the most robust one supported by both Windows and macOS.

To show the Browser, do any of the following:

- Press **Menu** and then tap **Browser**.
- Press **Browse** (MPC X, MPC One, MPC Studio), **Shift+Menu/Browse** (MPC Live, MPC Live II, MPC Key 61, MPC Touch), or **Load** (MPC Key 37).

To browse for files, tap **Browse** in the lower-left corner. See the [Browse](#) section to learn about this.

To view the project's sample pool and pads, tap **Sample Assign** in the lower-left corner. See the [Sample Assign](#) section to learn about this.

## Browse

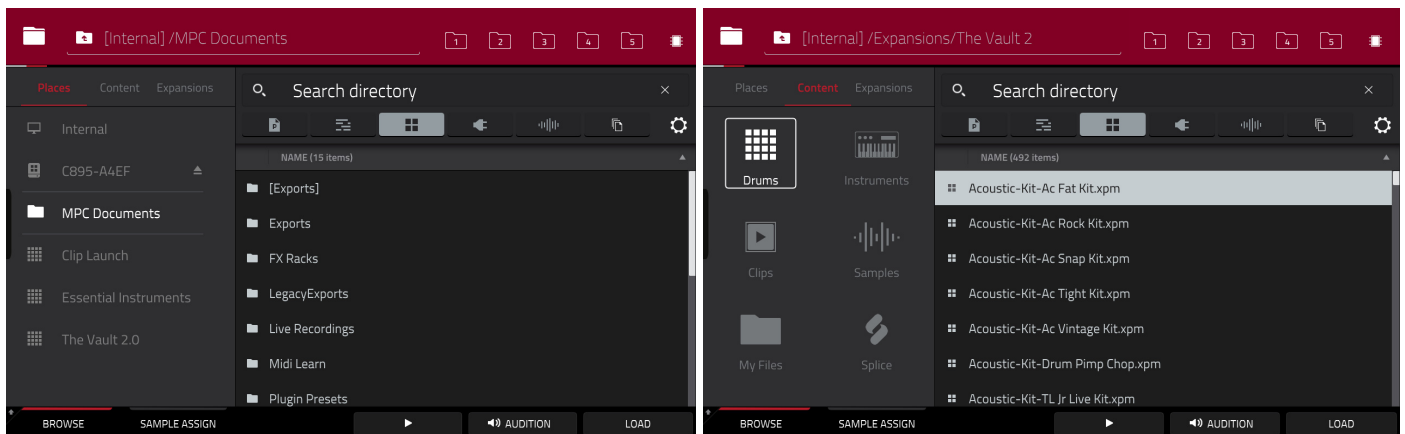

When the **Browse** tab is selected, you can do any of the following:

To browse your files by location, tap **Places** on the left side of the screen.

**Internal** is the internal drive of MPC X/Live/Live II/One/Key 61/Key 37.

**MPC Documents** is a shortcut to the **MPC Documents** folder on the internal drive of MPC X/Live/Live II/One/Key 61/Key 37.

If you have storage devices connected to USB ports or SD card slot of MPC X/Live/Live II/One/Key 61/Key 37, or your computer (with MPC Studio or MPC Touch), they will appear in this column, as well.

To browse your files by content, tap **Content** and then tap the type of file: **Drums**, **Instruments**, **Clips**, **Samples**, **My Files**, or **Splice** (see [below](#) to learn about these content buttons).

To browse your MPC Expansions (MPC X/Live/Live II/One/Key 61/Key 37 only), tap **Expansions** (see [Addenda > Updates in MPC 2.1 > New Features > Exporting Expansions](#) to learn how to export MPC Expansions from your computer to your MPC).

To move up one folder level, tap the **folder/↑** icon in the upper-left corner.

To move through a list, swipe up or down, turn the **data dial** or use the **-/+** buttons.

To select a file or folder, tap it once.

**To enter a folder**, double-tap it or tap **Open** in the lower-right corner. Alternatively, press the **data dial**, or press the **center cursor** or **Enter** (MPC X), to enter a selected folder. You can also tap one of the **folder buttons (1–5)** in the upper-right corner to jump immediately to those pre-assigned file paths (see [below](#) to learn how to assign these file paths).

**To load a selected file**, double-tap it, tap **Load**, press the **data dial**, or press the **center cursor** or **Enter** (MPC X). If the file is a sample, it will be loaded to the project's sample pool. If the file is a project, it will be loaded in its entirety (you will be asked if you want to close your current project).

**To load all files in a folder**, select the folder (so it is highlighted in the list), press and hold **Shift**, and then tap **Load All** in the lower-right corner.

**Important:** Although you can load multiple files at once, any samples you load into a project will be automatically converted to full-quality uncompressed audio files, so they may use more storage space than they do on your external storage device. If you are unable to load multiple files at once due to this, select fewer files and try again.

**To delete a selected file or folder**, press and hold **Shift** and then tap **Delete File** at the bottom of the screen.

**To preview a selected sound**, tap and hold **Play** (▶) at the bottom of the screen.

**To enable or disable the audition function and set its volume level**, tap **Audition** at the bottom of the screen. In the screen that appears, tap **Auto** to enable or disable it, and tap and drag the **level slider** up or down to set the volume level. Use the **Sync** and **Warp** buttons to audition samples and loops in time with your sequence. See [Addenda > Updates in MPC 2.5 > New Features > Browser Audition Warp and Sync](#) for more information. Tap **Audition** once more to hide the window.

**To show the information for the current storage device**, press and hold **Shift** and then tap **Drive Info** at the bottom of the screen. The drive's information will appear in a new window. Tap **OK** to return to the previous screen.

**To format a storage device to use an exFAT file system**, select it in the **Browser**, press and hold **Shift** and then tap **Format Drive** at the bottom of the screen. In the window that appears, tap **OK** and then **Format** in the next window to format the device, or tap **Cancel** to return to the previous screen without formatting. This formatting process will set the device to use the exFAT file system, remove any partitions from the drive, and erase all of its content. (Devices that are uninitialized or do not have a file system will not be recognized by the MPC hardware and consequently cannot be formatted.)

Tap the **gear icon** to open the Browser settings window.

Tap the **Show file size**, **Show modified date** or **Show created date** boxes to show the respective file information in the list.

Tap the **Search includes subfolders** box to enable recursive searching. When enabled, searching a directory will also search all subfolders within it.

Tap the **Hide project data folders** box to enable or disable MPC project folders from appearing in the file list.

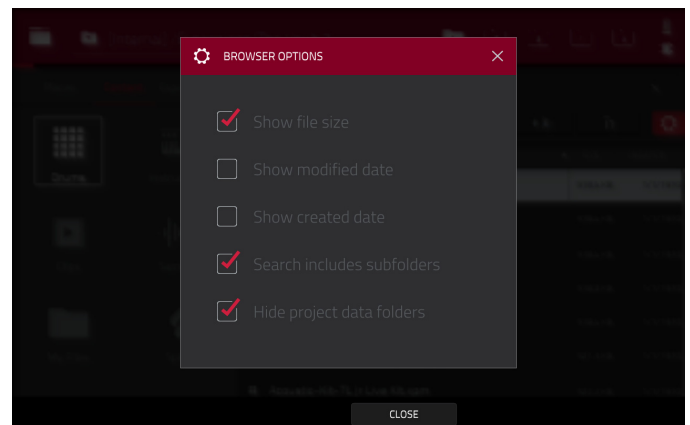

To get the most efficient use of the Browser, set the file paths to your favorite drive locations first. There are five **folder buttons** labeled **1–5** in the upper-right corner. You can set these to be shortcuts to five locations on your MPC hardware's internal drive and/or any connected storage devices, giving you quick access to your files.

**To assign the current location to a folder button**, press and hold **Shift**, and then tap one of the **folder buttons (1–5)**. Now, when you tap that folder button again, the Browser will show that folder's content immediately.



Use the six filter buttons to show only specific types of files in the list below. Folders will still be shown in the list.



**To show project files only**, tap the **P/page icon**.

**To show sequence files only**, tap the **bars icon**.

**To show program files only**, tap the **four-squares icon**.

**To show preset files only**, tap the **plug icon**.

**To show sample files only**, tap the **waveform icon**.

**To show all file types**, tap the **three-pages icon**.

Use the six **Content** buttons to show specific locations in the internal drive of MPC X/Live/Live II/One/Key 61/Key 37 and filter them automatically by file type:

**Drums:** Tap this button to enter the **Expansions/The Vault 2** folder on the internal drive, viewing **program** files only.

**Instruments:** Tap this button to enter the **Expansions/Instruments** folder on the internal drive, viewing **program** files only.

**Clips:** Tap this button to enter the **Expansions/Clips** folder on the internal drive, viewing **program** files only.

**Samples:** Tap this button to enter the **Expansions/The Vault 2** folder on the internal drive, viewing **sample** files only.

**My Files:** Tap this button to enter the **MPC Documents** folder, viewing **all** files.

**Splice:** Tap this button to view samples synced from a paired Splice account. See [Operation > Menu > Preferences > Splice](#) for more information.

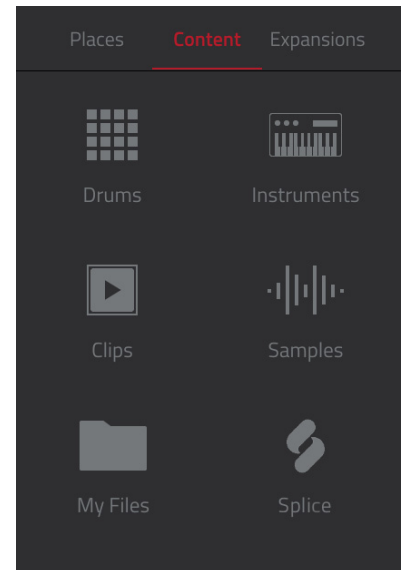

## Sample Assign

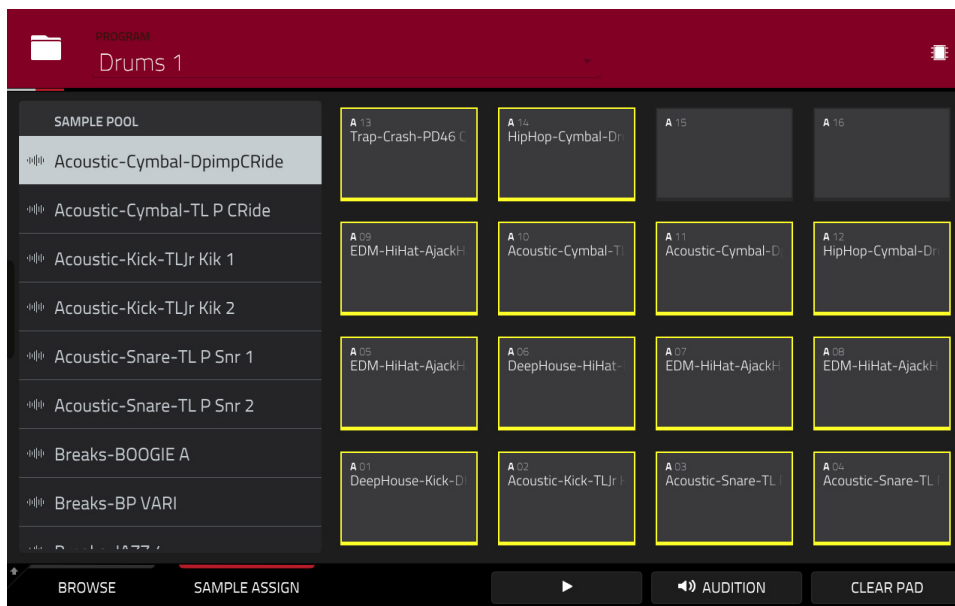

When the **Sample Assign** tab is selected, you can do any of the following:

**To select a program in the project**, double-tap the **Program** field at the top of the screen. In the list that appears, tap the desired program. Alternatively, tap the **Program** field and then use the **data dial** or the **-/+** buttons to select a location.

**To move through the sample pool**, swipe up or down, turn the **data dial**, or use the **-/+** buttons.

**To preview a selected sound**, tap and hold **Play** (▶) at the bottom of the screen.

**To enable or disable the audition function and set its volume level**, tap **Audition** at the bottom of the screen. In the screen that appears, tap **Auto** to enable or disable it, and tap and drag the **level slider** up or down to set the volume level. Tap **Audition** once more to hide the window.

**To assign a sample to a pad**, press it or tap it on the screen so it lights **green**. Then, in the **Sample Pool** list, tap the desired sample. Alternatively, use the **data dial** or **-/+** buttons to select a sample, and press the **data dial**, or press the **center cursor** or **Enter** (MPC X), to assign it. You can also tap and drag from the sample name to the desired pad. Hold **Shift** while tapping and dragging to move the sample to a specific layer on the pad, indicated by the red bar.

**To clear a sample from a pad**, press it or tap it on the screen so it lights **green**. Then, tap **Clear Pad** at the bottom of the screen.

**To delete a sample**, tap and hold on the sample name until **Delete Sample** appears, and then tap it.

## Sampler

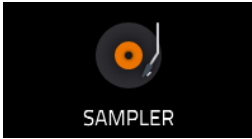

The Sampler lets you record audio samples to use in your projects.

**Important:** To record any audio, you need to connect an audio source to your MPC hardware or to your computer's audio interface.

To open the **Sampler**, do any of the following:

- Press **Menu** and then tap **Sampler**.
- Press **Sampler** (MPC X, MPC One), **Shift+Mix/Sampler** (MPC Live II), or **Shift+Sample Edit/Sampler** (MPC Key 61, MPC Key 37).
- Press and hold **Mode** and press **Pad 13** (MPC Studio).

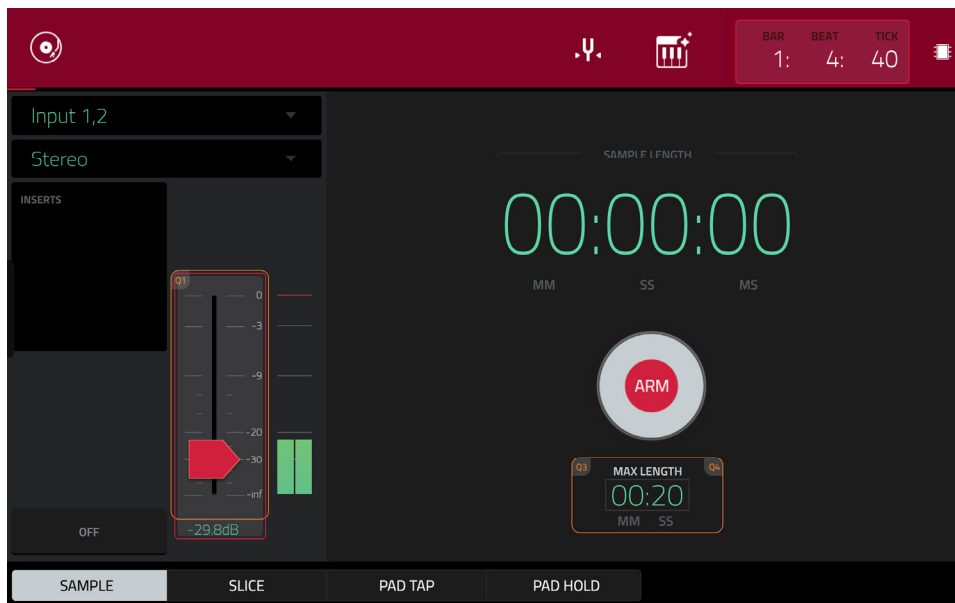

To set up the Sampler before recording:

1. Make sure to reduce the volume levels of your audio source and speakers, headphones, and/or monitors before you make any connections to avoid “pops” or feedback.
2. Connect a synthesizer or other line-level audio source to the input/inputs of your MPC hardware.
3. Turn the **3/4 Rec Gain** (MPC X), **Gain** (MPC Key 61), or **Rec Vol** (MPC Live, MPC Live II, MPC One, MPC Key 37, MPC Touch) knob to set the input level while playing your audio source. You should now see the level in the meter. Make sure it does not exceed the maximum level (the meter should not be “peaking” constantly).
4. Set the recording controls as desired (described in this chapter).
5. Tap the **Arm** button to record-arm the Sampler.

You can use the Sampler to record using four different methods: **Sample**, **Slice**, **Pad Tap**, or **Pad Hold**, all described later in this chapter. The following controls are present regardless of which method you use.

The Sampler page also contains the **Auto Sampler**, which lets you capture and convert any plugin preset or external instrument preset into a Keygroup sampler patch.

The time counter in the upper-right corner shows the current playhead position. This is shown in most of the modes. See [General Features > Time Counter/Locate](#) to learn about this.

Tap the **tuning fork icon** to open the tuner. See [Operation > Menu > Tuner](#) for more information.

The upper-left **Input Source** field defines whether you are going to record an external audio signal, which you can set to a pair of inputs (**Input 1,2-3,4** in Standalone Mode, **Input 1,2-31,32** in Controller Mode) or a single input (**Input 1-4** in Standalone Mode, **Input 1-32** in Controller Mode). You can also select an internal signal from within your MPC hardware (**Resample L**, **Resample R**, or **Resample L+R**).

Resampling does not require an audio connection because the source is internal and is therefore recorded without any loss in audio quality. You can, for example, use Resample to record two or more samples by pressing the corresponding pads simultaneously.

Use the second upper-left **Mono/Stereo** field to choose whether your recorded samples will be monaural (**Mono**) or binaural (**Stereo**).

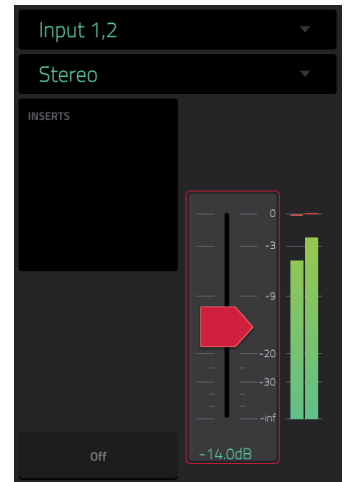

The **Inserts** field shows any enabled or disabled effects for the Sampler. Tap the area under **Inserts** to open a window where you can load, change, and enable or disable the effects.

**Important:** These effects are applied to the audio as you record it. This means that the effects cannot be “removed” from the sound later. Learn more about how effects work in [General Features > Effects](#).

Tap the **Monitor** button to enable or disable input monitoring. When set to **In**, the audio you hear in your headphones will be taken **before** it reaches the Sampler, ensuring zero latency. When off, the audio you hear in your headphones will be taken **after** it is processed in the Sampler, so there may be some latency, but you will hear the audio source as it sounds in the recording.

**Tip:** To avoid possible clicks or feedback while input monitoring, reduce the level of the audio sources.

Use the **threshold slider** to adjust the threshold. Alternatively, turn **Q-Link Knob 1** (MPC X) or the **first Q-Link knob** in the **fourth column** (MPC Live, MPC Live II, MPC One, MPC Key 61, MPC Key 37, MPC Touch).

When the Sampler is record-armed, it automatically starts recording when the level of the incoming source exceeds this setting. If you set it too high, the recording may not start when you play the input source, or the start of the material you wanted to record may be missing. If you set it too low, the recording may start too early, before you play the external source. Set this parameter to an appropriate level using the level meter.

**To reset the “peak hold,”** which shows the highest level of your input signal in the level meter, tap it.

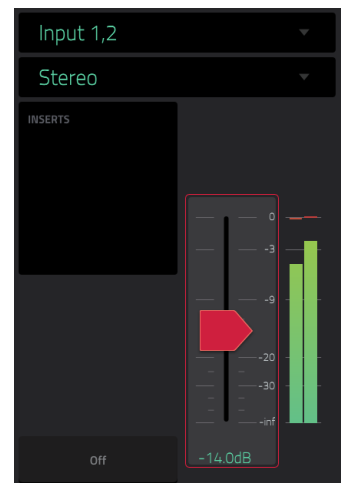



For reference, the **Sample Length** counter shows you the length of your sample during the recording procedure.

Tap **Arm** to record-arm the Sampler. The button will then change to **Record** and show **Waiting for signal**.

At that point, start recording by doing either of the following:

- Start performing so that the incoming audio level exceeds the level of the **threshold slider**.
- Tap **Record** under the **Sample Length** counter.

To disarm the track instead, tap **Cancel**.

Use the **Max Length** field to define the maximum sampling time. Alternatively, turn the **Q-Link Knobs 3 and 4** (MPC X) or the **third and fourth Q-Link knobs** in the **fourth column** (MPC Live, MPC Live II, MPC One, MPC Key 61, MPC Key 37, MPC Touch): **Minutes** and **Seconds**.

You can record up to 19 minutes and 59 seconds (**19:59**) per sample. We recommend setting these to values that roughly match your estimated recording duration.

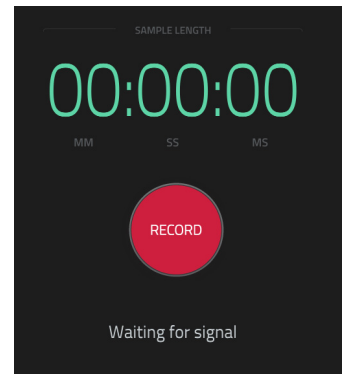
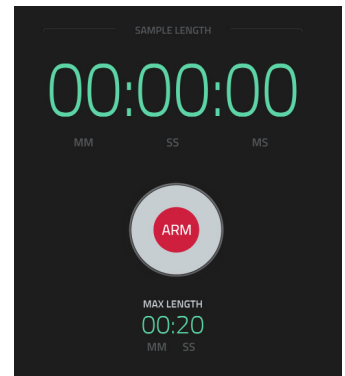

## Sample

Using this method, you can insert slice markers directly in your sample as you record it.

Slice markers divide the sample into multiple regions called **slices**, which you can adjust in the Chop Mode of Sample Edit Mode (see [Sample Edit Mode > Chop Mode](#) for more information). This is useful when working with a long sample with different sounds throughout (e.g., a drum loop or a long melodic or harmonic passage).

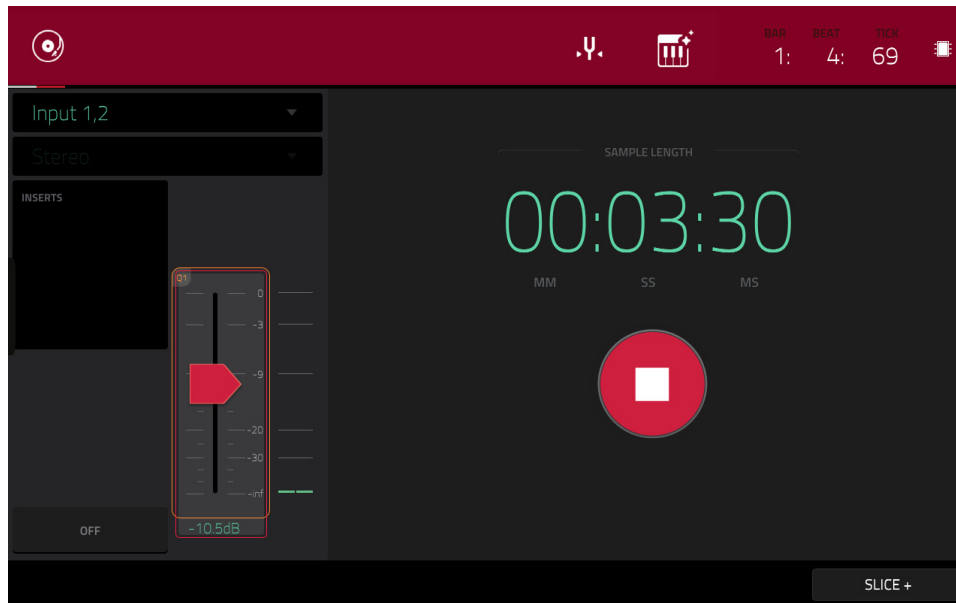

**To start recording**, do one of the following:

- Start performing so that the incoming audio level exceeds the level of the **threshold slider**.
- Tap **Record** under the **Sample Length** counter.

**To insert a slice marker in a sample while recording**, tap **Slice+** (in the lower-right corner) as the sample records. Each time you tap it, a slice marker will be placed at that location.

**To stop recording**, tap **Stop** under the **Sample Length** counter.

After you stop your recording, the **Keep or Discard Sample** window will appear.

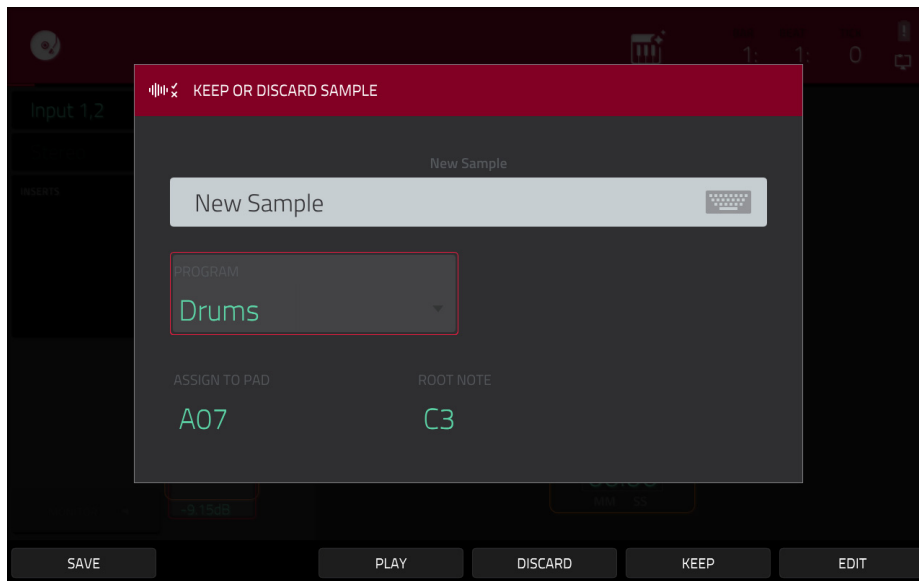

Use the **Edit Name** field to name the new sample. Tap it and use the virtual keyboard that appears.

Use the **Program** field to assign the new sample to a program. Select **<none>** if you want to save it to the project without assigning it to a program.

Use the **Assign to Pad** field to assign the sample to a pad in the program.

Use the **Root Note** field to set where the sample's original pitch will be on the keyboard.

If you recorded a sample while a sequence was playing, the **Keep or Discard Sample** window will show a few more options after you select a pad.

Check the **Add Event** box to automatically add the sample to the currently playing sequence.

Use the **@** field to select where you want the event to start:

- **Start:** The sample will be a note event at the start of the currently playing sequence.
- **Trigger:** The sample will be a note event where you began recording it in the currently playing sequence.

Use the **Track** field to set which track will contain the new event.

**To confirm your selections**, tap **Keep** at the bottom of the screen.

**To discard the recording and return to the Sampler**, tap **Discard** at the bottom of the screen.

**To play the recording**, tap **Play** at the bottom of the screen.

**Tip:** We recommend editing your recorded sample in **Sample Edit Mode** (see [Sample Edit Mode](#) for more information).

## Slice

Using this method, the pads correspond to slices of the currently recorded sample. Slice markers divide the sample into multiple regions called **slices**, which you can adjust in the Chop Mode of Sample Edit Mode (see [Sample Edit Mode > Chop Mode](#) for more information). This is useful when working with a long sample with different sounds throughout (e.g., a drum loop or a long melodic or harmonic passage).

**To start recording**, do one of the following:

- Start performing so that the incoming audio level exceeds the level of the **threshold slider**.
- Tap **Record** under the **Sample Length** counter.

**To insert a slice marker in a sample while recording**, press any **pad** as the sample records. Each time you press it, a slice marker will be placed at that location.

The number of the pad that flashes **red** is the number of the slice marker that will be inserted next. The numbers of the pads that are lit **yellow** are the numbers of the slice markers that are already inserted.

When you are done recording, you can name the sample and create a new program using the slices.

**To stop recording**, tap the round **Stop** button.

After you stop your recording, the **Keep or Discard Sample** window will appear.

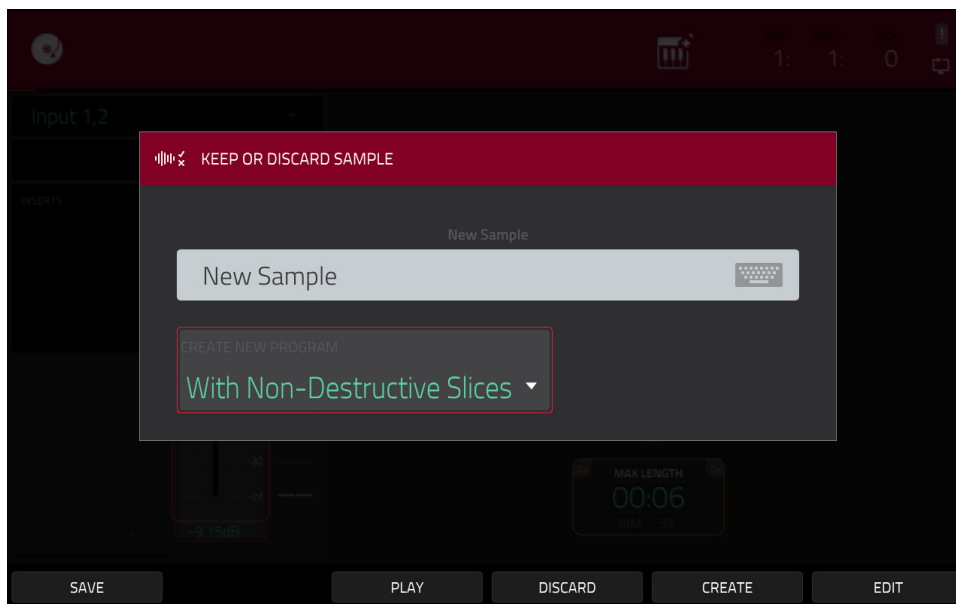

Use the **Edit Name** field to name the new sample. Tap it and use the virtual keyboard that appears. Otherwise, the process will add a consecutive number after the sample name.

Use the **Create New Program** field to assign the new sample to a new program:

**Off:** No program will be created. The slices will still be added to your project's sample pool.

**With Non-Destructive Slices:** In the new program, each pad's **Slice** setting will be set to the corresponding slice number. This is identical to how you can assign samples in Sample Edit Mode (as described in [Sample Edit Mode > Chop Mode > Converting or Assigning Slices](#)).

**With Pad Parameters:** In the new program, each pad's **Slice** setting will be set to **Pad**. The **Pad Start** and **Pad End** will be set to the slice's start point and end point values, and the **Loop Position** will be set to the slice's start point but with **Pad Loop** deactivated. This is identical to how you can assign samples in Sample Edit Mode (as described in [Sample Edit Mode > Chop Mode > Converting or Assigning Slices](#)).

**To confirm your selections**, tap **Create** or **Keep** at the bottom of the screen.

**To discard the recording and return to the Sampler**, tap **Discard** at the bottom of the screen.

**To play the recording**, tap **Play** at the bottom of the screen.

**Tip:** We recommend editing your recorded sample in **Sample Edit Mode** (see [Sample Edit Mode](#) for more information).

## Pad Tap

**Important:** This mode works for **drum programs only**; you must select a drum program before using this mode. Otherwise, this feature will not do anything, even though it may appear to work.

With this method, pressing a pad immediately starts or continues recording directly to that pad (make sure you are using the desired program before you start recording). Pads with assigned samples are lit **bright yellow**. Pads without samples are lit **dim yellow**.

**To start recording to a pad**, press it. Recording will start immediately, and the pad will flash **red**. If you press a new pad, the recording will stop on the previous pad, which will turn **green**, and start on the new pad, which will flash **red**.

**Note:** If you start recording by tapping **Record** under the **Sample Length** counter—or if the volume exceeds the level of the **threshold slider**—the sample will record to your project's sample pool, not to a pad.

**To stop recording to a pad**, press the currently recording **pad**, which is flashing **red**. The sample will continue recording. You can start recording on another **pad** at any time.

**To stop all recording**, tap **Stop** under the **Sample Length** counter.

When you are done recording, each pad that you have pressed during recording:

- will have its **Slice** setting set to **Pad**;
- will have its **Pad Start** and **Pad End** set to the slice's start point and end point values; and
- will have its **Loop Position** set to the slice's start point but with **Pad Loop** deactivated.

This is identical to how you can assign samples in Sample Edit Mode (as described in [Sample Edit Mode > Chop Mode > Converting or Assigning Slices](#)).

**Tip:** We recommend editing your recorded sample in **Sample Edit Mode** (see [Sample Edit Mode](#) for more information).

## Pad Hold

**Important:** This mode works for **drum programs only**; you must select a drum program before using this mode. Otherwise, this feature will not do anything, even though it may appear to work.

With this method, pressing and holding a pad immediately starts or continues recording directly to that pad (make sure you are using the desired program before you start recording). Pads with assigned samples are lit **bright yellow**. Pads without samples are lit **dim yellow**.

**To start recording to a pad**, press and hold it. Recording will start immediately, and the pad will light **red**.

**Note:** If you start recording by tapping **Record** under the **Sample Length** counter—or if the volume exceeds the level of the **threshold slider**—the sample will record to your project's sample pool, not to a pad.

**To stop recording**, release the **pad**. The pad will light **green**, and the sample will continue recording. You can start recording on another **pad** at any time.

**To stop all recording**, tap **Stop** under the **Sample Length** counter.

When you are done recording, each pad that you have pressed during recording:

- will have its **Slice** setting set to **Pad**;
- will have its **Pad Start** and **Pad End** set to the slice's start point and end point values; and
- will have its **Loop Position** set to the slice's start point but with **Pad Loop** deactivated.

This is identical to how you can assign samples in Sample Edit Mode (as described in [Sample Edit Mode > Chop Mode > Converting or Assigning Slices](#)).

**Tip:** We recommend editing your recorded sample in **Sample Edit Mode** (see [Sample Edit Mode](#) for more information).

## Auto Sampler

The Auto Sampler allows you to capture and convert any plugin preset or external instrument preset into a Keygroup sampler patch.

To open the Auto Sampler, press the **Auto Sampler** icon in the toolbar.



### Sample Source Information

The **Track name** and **Program name** fields show the target track and program that will be sampled. This will be automatically selected as the active track and program when Auto Sampler is opened.

Use the **Record from** field to select an external or resample input to record from:

To capture the output of a plugin, simply select a Plugin track before opening Auto Sampler.

**Note:** When a plugin track is selected, the Auto Sampler will only sample the plugin track, regardless of the setting in the **Record From** field.

To capture a preset from an external instrument such as a sound module, select the **Input** that the external instrument is connected to.

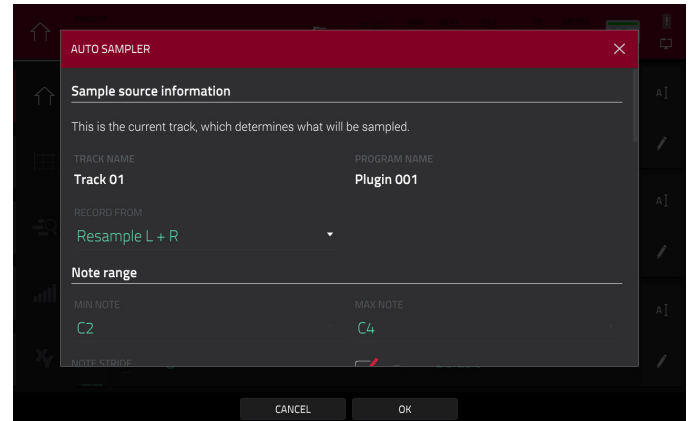

### Note Range

Use the **Min note** and **Max note** settings to determine the lowest and highest notes used to create the sampler patch.

Use the **Note stride** to determine the range of notes that each sample will cover. For instance, a note stride of **5** means that every 5 notes will utilize a different sample.

Check the **Extend min/max notes** box to sample all the way to the lowest and highest notes, regardless of the **Min Note** and **Max Note** settings.

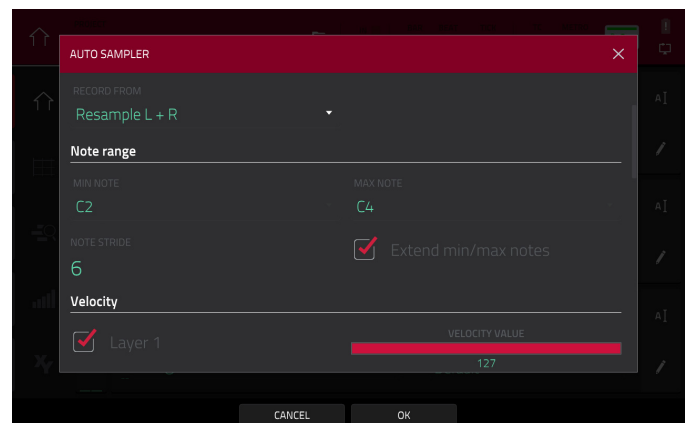

### Velocity

Tap the boxes next to **Layers 1–4** to select how many layers will be used to create the sampler patch.

Use the **Velocity** value sliders to set the velocity of each layer.

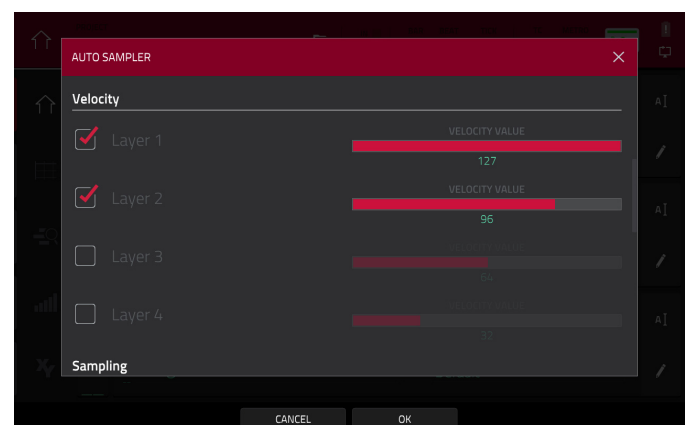

## Looper

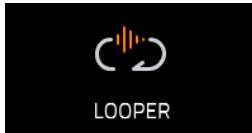

The Looper lets you record and overdub audio in real time—a great tool for live performance as well as spontaneous moments in the studio. You can export the loop as a sample to use in your project.

To open the Looper, do either of the following:

- Press **Menu**, and then tap **Looper**.
- Press **Shift+Sampler/Looper** (MPC X, MPC One).
- Press and hold **Mode** and press **Pad 14** (MPC Studio).



Below is a brief step-by-step process so you can get started quickly. Continue reading the rest of this chapter to learn how to use the Looper in different cases.

### To get started using the Looper:

1. Make sure to reduce the volume levels of your audio source and speakers/headphones/monitors before you make any connections to avoid “pops” or feedback.
2. Connect a synthesizer, audio player, etc. to the input/inputs of your MPC hardware.
3. Turn the **3/4 Rec Gain** (MPC X), **Gain** (MPC Key 61), or **Rec Vol** (MPC Live, MPC Live II, MPC One, MPC Key 37, MPC Touch) knob to set the input level while playing your audio source. You should now see the level in the meter. Make sure it does not exceed the maximum level (the meter should not be “peaking” constantly).
4. Set the recording controls as desired (described in this chapter).
5. Tap the **Record To** selector so **Overdub** is selected.
6. Tap the **Rec/Record** button in the lower-right corner to record-arm the Looper.
7. Play your audio source. The Looper will start recording immediately when the input level reaches the threshold value. Alternatively, tap **▶/Play** at the bottom of the screen to manually start recording.

Each time the Looper repeats, its contents are being overdubbed—a new layer of audio will be added each time you let the Looper repeat as it records.

**Tip:** You can record a loop while playing a sequence in the background for reference.

8. To stop recording, tap **▶/Play** at the bottom of the screen.

To export your loop as a sample, tap **Export** to open the **Keep or Discard Sample** window.

To clear the contents of the Looper, tap **Clear**.



The time counter at the top of the screen indicates the current playhead position. This is shown in most of the modes. See [General Features > Time Counter/Locate](#) to learn about this.

The upper-left **Input Source** field defines whether you are going to record an external audio signal, which you can set to a pair of inputs (**Input 1,2–3,4** in Standalone Mode, **Input 1,2–31,32** in Controller Mode) or a single input (**Input 1–4** in Standalone Mode, **Input 1–32** in Controller Mode). You can also select an internal signal from within your MPC hardware (**Resample L**, **Resample R**, or **Resample L+R**).

Resampling does not require an audio connection because the source is internal and is therefore recorded without any loss in audio quality. You can, for example, use Resample to record two or more samples by pressing the corresponding pads simultaneously.

Use the second upper-left **Mono/Stereo** field to choose whether your recorded loop will be monaural (**Mono**) or binaural (**Stereo**).

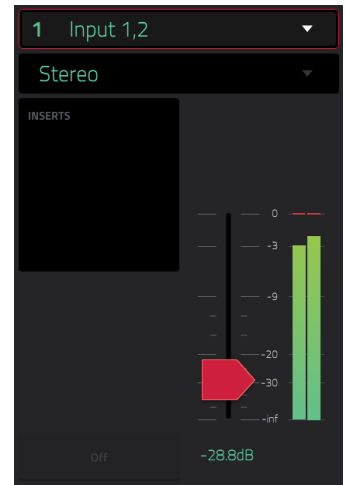

The **Inserts** field shows any enabled or disabled effects for the Looper. Tap the area under **Inserts** to open a window where you can load, change, and enable or disable the effects.

**Important:** These effects are applied to the audio as you record it. This means that the effects cannot be “removed” from the sound later. Learn more about how effects work in [General Features > Effects](#).

Tap the **Monitor** button to enable or disable input monitoring.

When set to **In**, the audio you hear in your headphones will be taken **before** it reaches the Looper, ensuring zero latency. You can turn input monitoring on only if the **Input Source** field is set to an input, not to a **Resample** setting.

When **off**, the audio you hear in your headphones will be taken **after** it is processed in the Looper, so there may be some latency, but you will hear the audio source as it sounds in the recording.

**Tip:** To avoid possible clicks or feedback while input monitoring, reduce the level of the audio sources.

Use the **threshold slider** to adjust the threshold. Alternatively, turn **Q-Link Knob 1 (Threshold)** on MPC X) or the **first Q-Link knob** in the **fourth column** (MPC Live, MPC Live II, MPC One, MPC Key 61, MPC Key 37, MPC Touch). The threshold slider will work only when **Sync** is **off** (see [below](#)).

When the Looper is record-armed, it automatically starts recording when the level of the incoming source exceeds this setting. If you set it too high, the recording may not start when you play the input source, or the start of the material you wanted to record may be missing. If you set it too low, the recording may start too early, before you play the external source. Set this parameter to an appropriate level using the level meter.

**To reset the “peak hold,”** which shows the highest level of your input signal in the level meter, tap it.

Use the **Bars** field to define the length of your loop. Regardless of how much or how little audio you record, this is how long your loop will be.

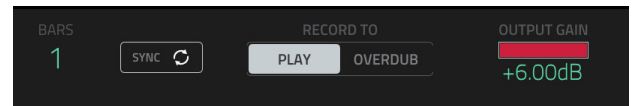

Use the **Sync** button to sync or un-sync the looper with sequence playback. When on, the Looper will stay in step with your current sequence. When you play or record into the Looper, it will wait until the sequence starts playing Bar 1 to start.

Use the **Record To** selector to determine the loop recording behavior:

**Play:** Before recording, you must first tap the ►/Play button on the screen, which will start playing the Looper.

**Overdub:** Before recording, you must first tap the **Rec/Record** button in the lower-right corner to record-arm the Looper.

Use the **Output Gain** slider to set the output signal level of the Looper.

To record with the Looper:

**Important:**

To record without erasing any audio you've already recorded in the loop, use the **Overdub** button.

To overwrite the audio you've already recorded, use the **Replace** button.



If **Record To** is set to **Play**:

To start recording, tap the **Replace** or **Overdub** button as the loop is playing. The Looper will start recording immediately.

To stop recording, tap the **Replace** or **Overdub** button. The Looper will stop recording but continue playing.

To stop playback and recording, tap the ►/Play button.

If **Record To** is set to **Overdub**:

To start recording, tap the ►/Play button on the screen.

If **Sync** is off, you can also play your audio source so that the input level reaches the threshold value.

If **Sync** is on, you can also press the **Play** or **Play Start** button to start playing a sequence; recording will start when the sequence starts on Bar 1.

To stop recording, tap **Overdub**. The Looper will stop recording but continue playing.

To stop playback and recording, tap the ►/Play button, or press **Stop** to stop sequence playback.

To play or stop the loop (without recording), tap the ►/Play button on the screen.

To reverse loop playback, tap **Reverse**. If **Sync** is on, playback will reverse once the Looper's playhead reaches the end of the loop. If **Sync** is off, playback will reverse immediately.

To erase the loop immediately, tap **Clear**.

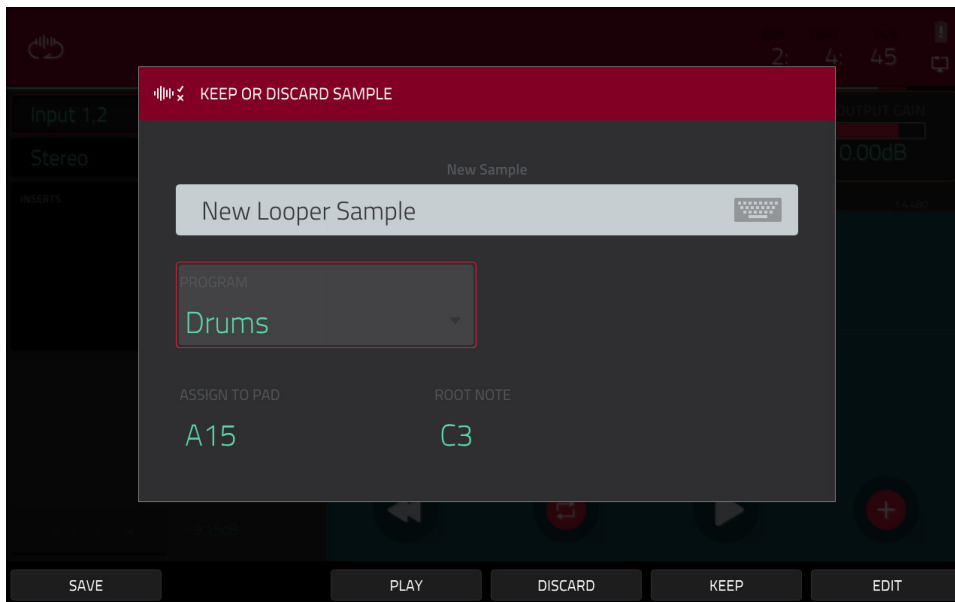

### To export the loop as a sample:

1. Tap **Export** to open the **Export Loop as a Sample** window.
2. Tap the **Edit Name** field and use the virtual keyboard that appears to enter a new name.
3. **Optional:** Use the **Program** field to assign it directly to a program. **To ignore this feature**, select **<none>**.
4. **Optional:** If you're assigning the sample to a program, use the **Assign to Pad** field to assign it to a specific pad. Alternatively, just press the pad. **To ignore this feature**, select **Off**.
5. Use the **Root Note** field to select the sample's root note.
6. **Optional:** Tap and hold your finger on **Play** to play the sample.
7. Tap **Do It** to confirm your choice, or **Cancel** to cancel.

When your loop is done exporting, it will be added to your project's sample pool with the name you entered and will be assigned to the program and pad you selected (if any).

## Pad Mixer

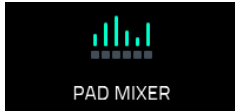

In the Pad Mixer, you can set a program's levels, stereo panning, routing, and effects.

This mode appears differently for each type of program:

For **drum programs**, this mode shows a pad with controls for each individual pad (of 128).

For **keygroup programs**, this mode shows a pad with controls for each individual keygroup (up to 128).

For **clip programs**, this mode shows a pad with controls for each individual clip (up to 16). Even though you can view other pad banks, only **Pad Bank A** is relevant for clip programs.

For **MIDI programs**, **plugin programs**, and **CV programs**, this mode is unavailable.

For more information on how these programs differ, please see [General Features > Programs](#).

To enter the Pad Mixer, do any of the following:

- Press **Menu**, and then tap **Pad Mixer**.
- Press **Pad Mixer** (MPC X), **Shift+Track Mix/Pad Mix** (MPC One), or **Shift+Mix/Pad** (MPC Key 61, MPC Key 37).
- Press and hold **Mode** and press **Pad 7** (MPC Studio).



The Pad Mixer works like an audio mixer with various settings for each pad, shown in a 4x4 array. All of their functionality is identical. If a sample has been assigned to a pad, its name is displayed at the top of it.

To **select a pad**, press its corresponding pad or tap it on the screen. Alternatively, use the numbered **Pad** field in the upper-left corner.

To **view more channels**, use the **Pad Bank** buttons.

Use the **Program** field in the upper-left corner to select the program whose pads you want to view. Remember that only drum programs, keygroup programs, or clip programs will display properly in the Pad Mixer.

Use the **Track** field at the top of the screen to select the desired track.

The time counter in the upper-right corner shows the current playhead position. This is shown in most of the modes. See [General Features > Time Counter/Locate](#) to learn about this.

The automation button indicates the global automation state. This is shown in several modes. See [General Features > Automation](#) to learn about this.

**To view a specific setting on all channels**, tap the **Level**, **Pan**, **Mute**, **Send**, **Insert**, or **Route** button at the bottom of the screen. You can tap the **Send** or **Insert** buttons multiple times to cycle through the four available slots for each.

When a pad is selected, you can view and adjust all of its settings in the left side of the screen rather than using the tab buttons at the bottom.

When viewing the channel strip:

The first field shows the current pad number. Press a **pad** or double-tap the **field** to select a different pad.

The second field shows where the pad is routed, which you can change: **Program** (the usual setting); **Out 1,2-7,8**, **Out 1-8** or **Sub 1-8** in Standalone Mode; and **Out 1,2-31,32** or **Out 1-32** in Controller Mode.

**Note:** When set to a mono channel, the left and right channels are summed post-pan knob. If the pan knob is set to the center position, the left and right channels will be summed and padded. If the pan knob is set to the maximum left or right positions, only the respective channel will be sent to the output.

The **Inserts** field shows any enabled or disabled effects for that pad. Tap the area under **Inserts** to open a window where you can load, change, and enable or disable the effects.

Tap **Solo** or **Mute** to solo or mute the pad (respectively).

Adjust the **pan knob** or **level slider** to change the panning or level of the pad.

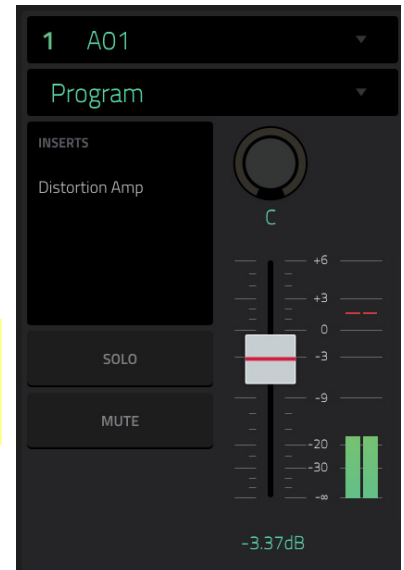

## Levels

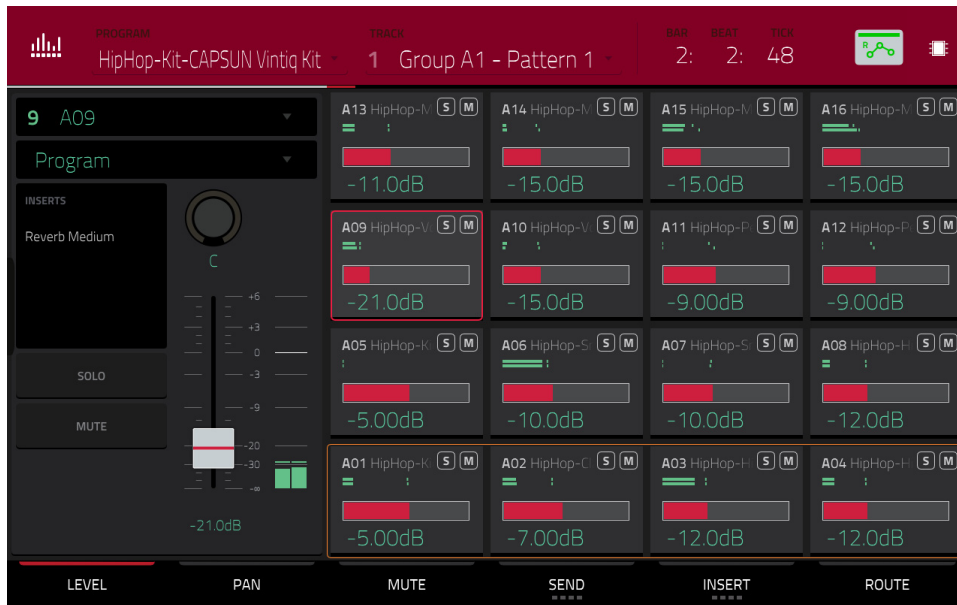

When the **Level** tab is selected, use the **data dial** or **-/+** buttons to adjust the level of the currently selected pad.

The level sliders and meters in each pad show a visual representation of the level. Double-tap a **pad** on the screen to open a large version of the level slider and meter.

## Panning

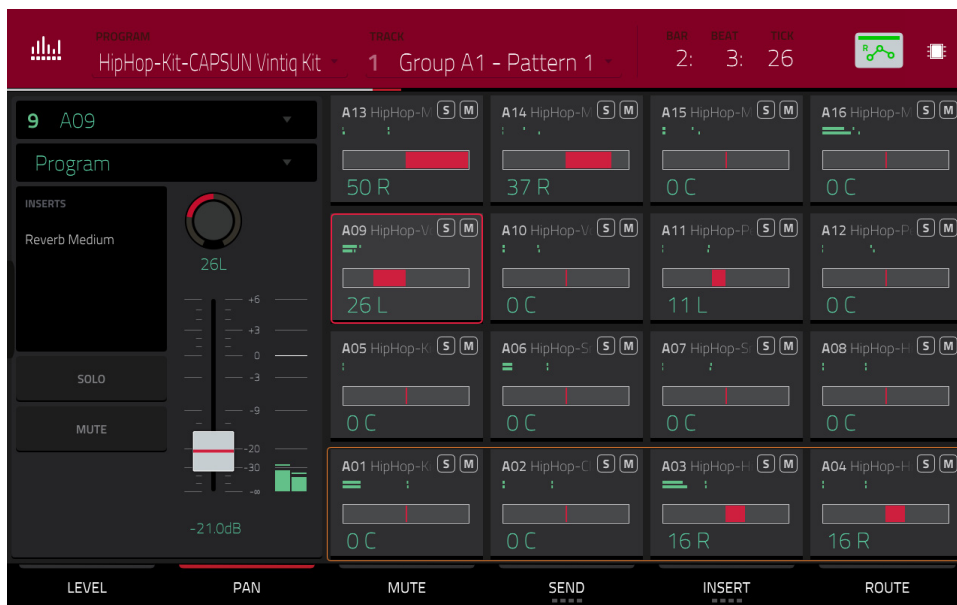

When the **Pan** tab is selected, use the **data dial** or **-/+** buttons to adjust the panning of the currently selected pad.

The pan sliders in each pad show a visual representation of the level. Double-tap a **pad** on the screen to open a large version of the **pan knob**.

## Mute

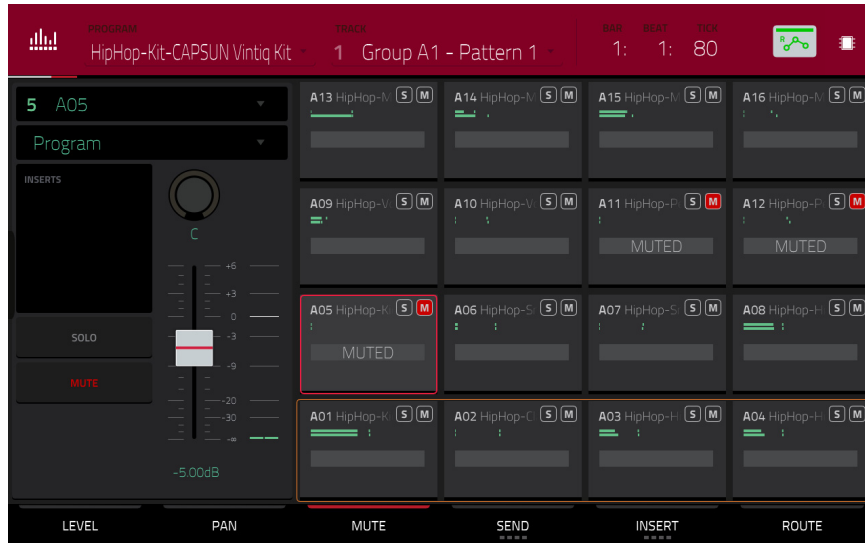

When the **Mute** tab is selected, mute the currently selected pad by doing any of the following:

- Turn the **data dial**.
- Use the **-/+** buttons.
- Tap the **pad** on the screen.

When a pad is muted, its **M** button will light **red**.

## Send Effects



When the **Send** tab is selected, use the **data dial** or **-/+** buttons to adjust the send level of the currently selected pad. The level sliders in each pad show a visual representation of the level. Double-tap a **pad** on the screen to open a large version of the level slider.

You can select up to **four send effects** for each pad. You can use various effects included in your MPC hardware as well as other VST and AU plugins installed on your computer. Tap the **Send** button to cycle through the four available slots for each.

To learn how to use send effects, please see [General Features > Effects > Send/Return Effects](#).

**Important: To use a send effect, you have to load an effect into the corresponding send effect slot in the Channel Mixer.**



## Insert Effects

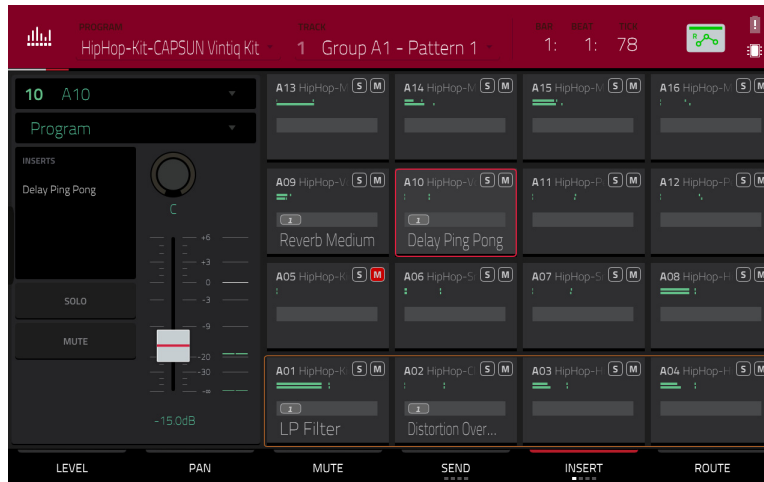

When the **Insert** tab is selected, use the **data dial** or **-/+** buttons to open a window where you can select an effect for the currently selected pad.

Instead of level sliders, there are fields that display 0–4 boxes to indicate which insert slots have a loaded effect.

The level meters in each pad show a visual representation of the level. Double-tap a **pad** on the screen to open a window where you can load, change, and enable or disable the effects for all four insert slots.

You can select up to **four insert effects** for each pad. You can use various effects included in your MPC hardware as well as other VST and AU plugins installed on your computer. Tap the **Insert** button to cycle through the four available slots for each.

To learn how to use insert effects, please see [General Features > Effects > Insert Effects](#).

### Important:

When using keygroup insert effects, they will be applied to that keygroup only. Keep this in mind if you load insert effects to multiple keygroups with overlapping note ranges—the effects will overlap in that range as well.

If a routing is set to anything other than **Program**, then a program insert effect will **not** be applied to that pad or keygroup.

## Routing

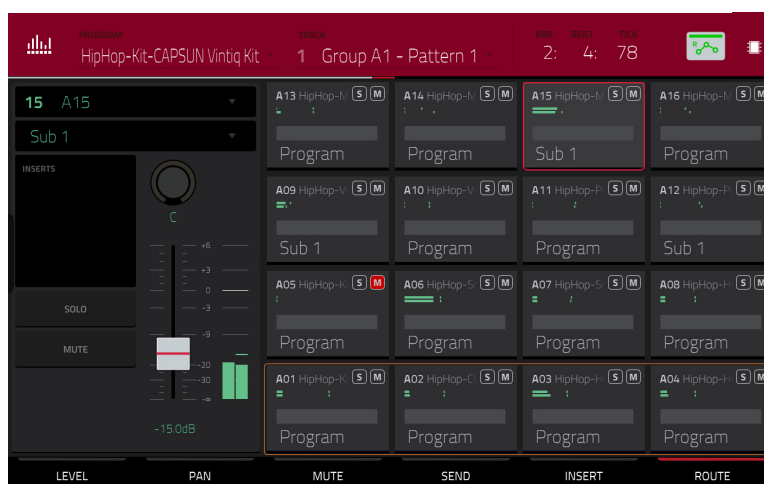

When the **Route** tab is selected, use the **data dial** or **-/+** buttons to select the output of the currently selected pad. Usually, this is set to **Program**. Double-tap a **pad** on the screen to select a different destination: **Out 1,2–7,8**, **Out 1–8** or **Sub 1–8** in Standalone Mode; and **Out 1,2–31,32** or **Out 1–32** in Controller Mode.

**Note:** When set to a mono channel, the left and right channels are summed post-pan knob. If the pan knob is set to the center position, the left and right channels will be summed and panned. If the pan knob is set to the maximum left or right positions, only the respective channel will be sent to the output.

## Channel Mixer



In the Channel (Track) Mixer, you can set levels, stereo panning, and other settings for your tracks, programs, returns, submixes and main outputs.

To open the **Channel Mixer**, do either of the following:

- Press **Menu**, and then tap **Channel Mixer**.
- Press **Ch. Mixer** (MPC X), **Track Mix** (MPC One), or **Mix** (MPC Key 61, MPC Key 37).
- Press and hold **Mode** and press **Pad 8** (MPC Studio).

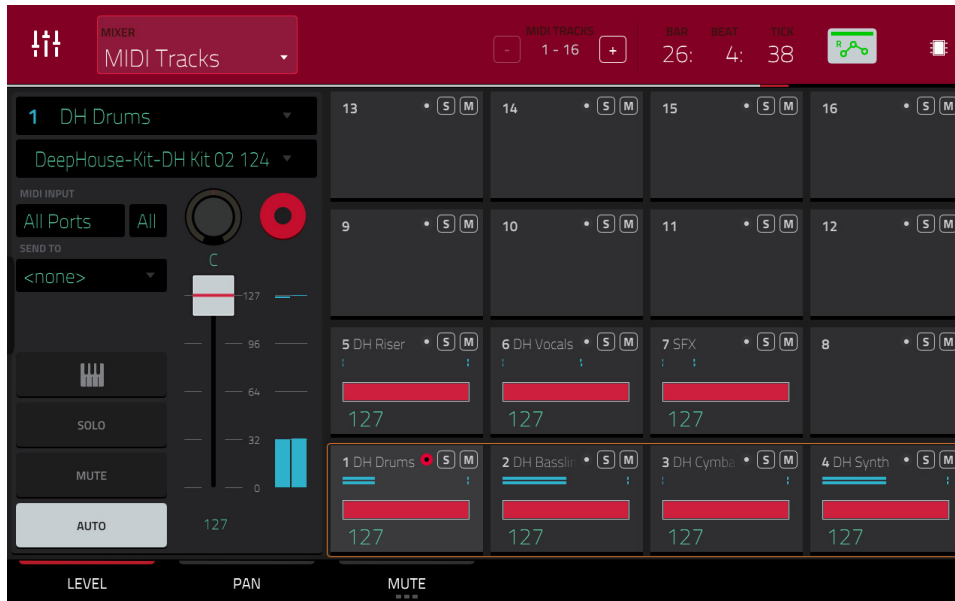

The Channel Mixer works like an audio mixer with various settings for each channel, shown in a 4x4 array. Their functionality is mostly identical. The name of the track, program, or channel is displayed at the top of each one.

Use the **Mixer** field at the top of the screen to select which mixer you want to view: **MIDI Tracks**, **Audio Tracks**, **Programs**, **Returns**, **Submixes**, or **Main Outputs**. Each page has slight differences, described in each section.

The following controls and tabs are available for all of the mixers (or most of them, as indicated).

**To select a channel**, tap its corresponding pad on the screen. Alternatively, use the field in the upper-left corner.

**To view more channels** (while viewing tracks or programs), use the **-/+** buttons at the top of the screen.

The time counter in the upper-right corner shows the current playhead position. This is shown in most of the modes. See **General Features > Time Counter/Locate** to learn about this.

The automation button indicates the global automation state. This is shown in several modes. See **General Features > Automation** to learn about this.

## Levels

When the **Level** tab is selected, use the **data dial** or **-/+** buttons to adjust the velocity level or volume level of the currently selected track, program, return, submix, or main output.

The level sliders and meters in each pad show a visual representation of the level. Double-tap a **pad** on the screen to open a large version of the level slider and meter.

## Panning

When the **Pan** tab is selected, use the **data dial** or **-/+** buttons to adjust the panning of the currently selected track, program, return, submix, or main output.

The pan sliders in each pad show a visual representation of the level. Double-tap a **pad** on the screen to open a large version of a **pan knob**.

## Mute/Solo/Rec Arm

Tap this tab to cycle it through **Mute**, **Solo**, and **Rec Arm** functions.

When **Mute** is selected, mute tracks, programs, returns, submixes, or main outputs by doing any of the following:

- Turn or press the **center cursor** or **Enter** (MPC X), or the **data dial** (MPC Live, MPC Live II, MPC One, MPC Key 61, MPC Key 37, MPC Touch).
- Use the **-/+** buttons.
- Tap the **pad** on the screen.
- Turn each of the **Q-Link knobs** to mute or unmute each of the pads.

When a track, program, return, submix, or main output is muted, its **M** button will light **red**.

When **Solo** is selected, solo tracks, programs, returns, submixes, or main outputs by doing any of the following:

- Turn or press the **center cursor** or **Enter** (MPC X), or the **data dial** (MPC Live, MPC Live II, MPC One, MPC Key 61, MPC Key 37, MPC Touch).
- Use the **-/+** buttons.
- Tap the **pad** on the screen.
- Turn each of the **Q-Link knobs** to solo or unsolo each of the pads.

When a track, program, return, submix, or main output is soloed, its **S** button will light **green** while other tracks are muted with their **M** buttons lit **red**.

The **Solo** tab is available for tracks and programs only.

When **Rec Arm** is selected, record-enable audio tracks by doing any of the following:

- Turn or press the **center cursor** or **Enter** (MPC X), or the **data dial** (MPC Live, MPC Live II, MPC One, MPC Key 61, MPC Key 37, MPC Touch).
- Use the **-/+** buttons.
- Tap the **pad** on the screen. Press and hold **Shift** while tapping a **pad** on the screen to record-enable multiple tracks at once.

**Send Levels** (audio tracks, programs, and submixes only)

When the **Send** tab is selected, use the **data dial** or **-/+** buttons to adjust the send level of audio tracks, programs, or submixes.

The level sliders in each pad show a visual representation of the level. Double-tap a **pad** on the screen to open a large version of the level slider.

You can use up to four send channels. Tap **Send** to cycle through the four available slots for each.

**To learn how to use send effects**, please see [General Features > Effects > Send/Return Effects](#).

**Important:** When using send channels, make sure you have already loaded at least one effect to it using the return mixer. See [Returns](#) below to learn how to do this.

**Insert Effects** (audio tracks, programs, returns, submixes, and main outputs only)

When the **Insert** tab is selected, use the **data dial** or **-/+** buttons to open a window where you can select an effect for the currently selected audio track, program, return, submix, or main output.

Instead of level sliders, there are fields that display 0–4 boxes to indicate which insert slots have a loaded effect.

The level meters in each pad show a visual representation of the level. Double-tap a **pad** on the screen to open a large version of the level slider.

You can select up to four insert effects for each audio track, program, return, submix, or main output. Tap the **Insert** button to cycle through the four available slots for each.

**To learn how to use insert effects**, please see [General Features > Effects > Insert Effects](#).

**Routing** (audio tracks, programs, returns, and submixes only)

When the **Route** tab is selected, use the **data dial** or **-/+** buttons to select the output of the currently selected program, return, or submix.

## MIDI Tracks

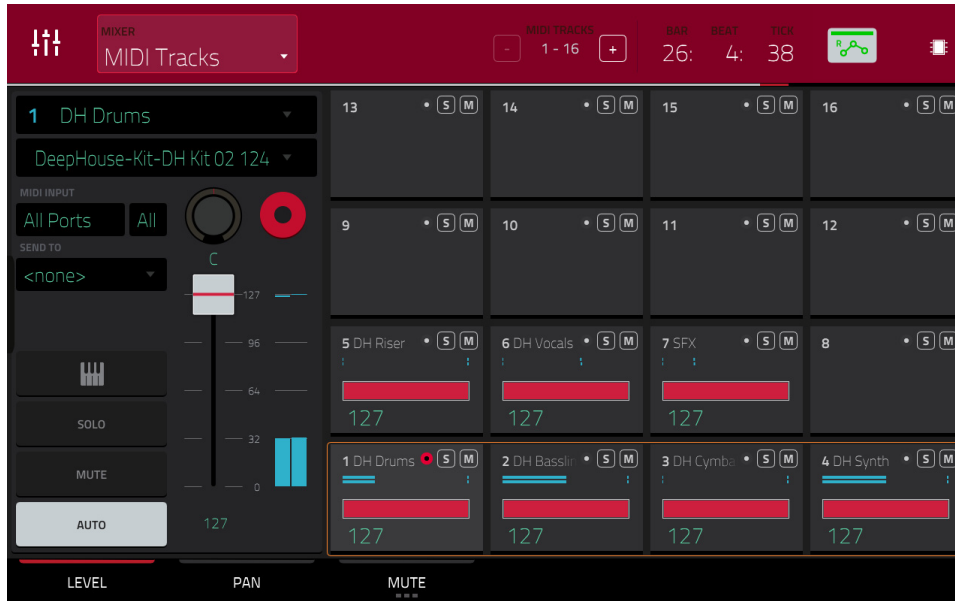

The MIDI Track Mixer shows levels, panning, and mute states for all used tracks.

**To view a specific setting on all tracks**, tap **Level**, **Pan**, or **Mute** at the bottom of the screen. Tap **Mute/Solo/Rec Arm** to switch between them.

When a track is selected, you can view and adjust all of its settings in the left side of the screen rather than using the tab buttons at the bottom.

When viewing the MIDI track channel strip:

**Note:** This is the same as the MIDI track channel strip in Main Mode.

The first field shows the current track (which you can change).

The second field shows the current program the track is using (which you can change to a program of the same type).

Use the **MIDI Input** and **Channel** fields to configure the MIDI input settings.

Use the **MIDI Output** and **Channel** fields to configure the MIDI output settings (MIDI tracks only).

Use the **Send To** field to send the track's MIDI output to another track.

Tap **Solo** or **Mute** to solo or mute the track (respectively).

Use the **monitor button** to set the monitor behavior for the track:

**Off:** The track's MIDI input is not monitored, and playback of recorded events will be heard. This setting is useful when using keyboards with Local Control active.

**In:** The track's MIDI input is always monitored regardless of the track's Record Arm state, and playback from recorded events will not be heard.

**Auto:** The track's MIDI input is monitored when the track is record armed, and playback of recorded events will be heard.

**Merge:** The track's MIDI input is always monitored, and playback of recorded events will be heard.

Adjust the **pan knob** or **velocity slider** to change the panning or velocity of the track.

## Audio Tracks

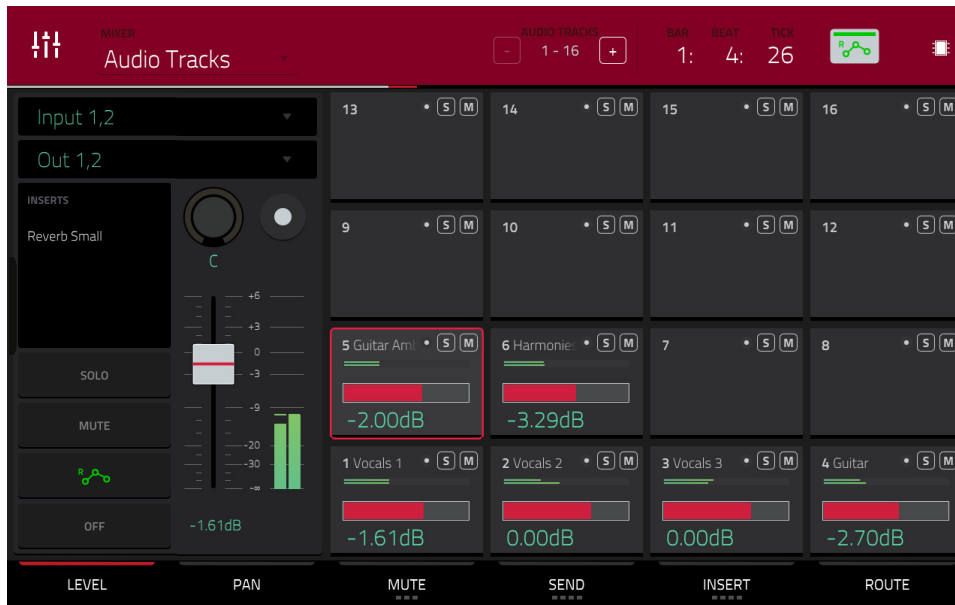

The Audio Track Mixer shows levels, mute/solo/record-arm states, send and insert effects, and routing for all used tracks.

**To view a specific setting on all tracks**, tap **Level**, **Pan**, **Mute/Solo/Rec Arm**, **Send**, **Insert**, or **Route** at the bottom of the screen. Tap **Mute/Solo/Rec Arm** to cycle through them.

When a track is selected, you can view and adjust all of its settings in the left side of the screen rather than using the tab buttons at the bottom.

When viewing the audio track channel strip:

**Note:** This is the same as the audio track channel strip in Main Mode.

The first field defines the input source of the external audio signal, which you can set to a pair of inputs (**Input 1,2-3,4** in Standalone Mode, **Input 1,2-31,32** in Controller Mode) or a single input (**Input 1-4** in Standalone Mode, **Input 1-32** in Controller Mode).

The second field shows where the track is routed, which you can change: **Out 1,2-7,8**, **Out 1-8** or **Sub 1-8** in Standalone Mode; and **Out 1,2-31,32** or **Out 1-32** in Controller Mode.

**Note:** When set to a mono channel, the left and right channels are summed post-pan knob. If the pan knob is set to the center position, the left and right channels will be summed and padded. If the pan knob is set to the maximum left or right positions, only the respective channel will be sent to the output.

The **Inserts** field shows any enabled or disabled effects for that audio track. Tap the area under **Inserts** to open a window where you can load, change, and enable or disable the effects for all four insert slots.

Tap **Solo** or **Mute** to solo or mute the track (respectively).

Tap the **Monitor** button to set how your audio track will be monitored. Tapping it will cycle through its three states:

When set to **Auto**, you will hear incoming audio while the track is record-enabled only.

When **on**, you will hear incoming audio whether or not the track is record-enabled.

When **off**, you will never hear any incoming audio.

Tap the **automation button** to toggle between its two states. Alternatively, press **Read/Write** (MPC X, MPC Key 61) or **Automation** (MPC Key 37).

When set to **Read (R)**, the audio track will read automation data but will not record any additional automation over it. (Think of this as a protective feature to prevent accidental changes to your automation while recording.)

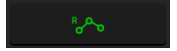

When set to **Write (W)**, the audio track can record automation. (If you have any Q-Link knobs assigned to automatable parameters, make sure not to touch any accidentally while you are recording.)



**Tip:** You can quickly set all programs and audio tracks to the same automation by tapping the global automation button in the upper-right corner of the screen. See [General Features > Automation](#) to learn about this.

Press and hold **Shift** and tap the **automation button** to disable program automation. Alternatively, press **Shift+Read/Write** (MPC X, MPC Key 61) or **Shift+Automation** (MPC Key 37). When **off**, the audio track will ignore automation data.

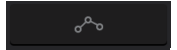

**Important:** If you have already recorded automation and turn it off, the audio track will still use the effect and its parameter values at the point where you turned it off.

Adjust the **pan knob** or **level slider** to change the panning or level of the track.

Tap the **Record Arm** button or press **Rec Arm** (MPC X) to record-enable the track. When you begin audio recording, the audio signal will be recorded to this track.

**Tip:** You can select multiple tracks in the **Rec Arm** tab by pressing and holding **Shift** and tapping each **pad** on the screen. You can also do this in the Track View by pressing and holding **Shift** while tapping the **Arm** button to each track. You can also set the Rec Arm preference to either Single or Multi in the [Preferences](#).

## Programs

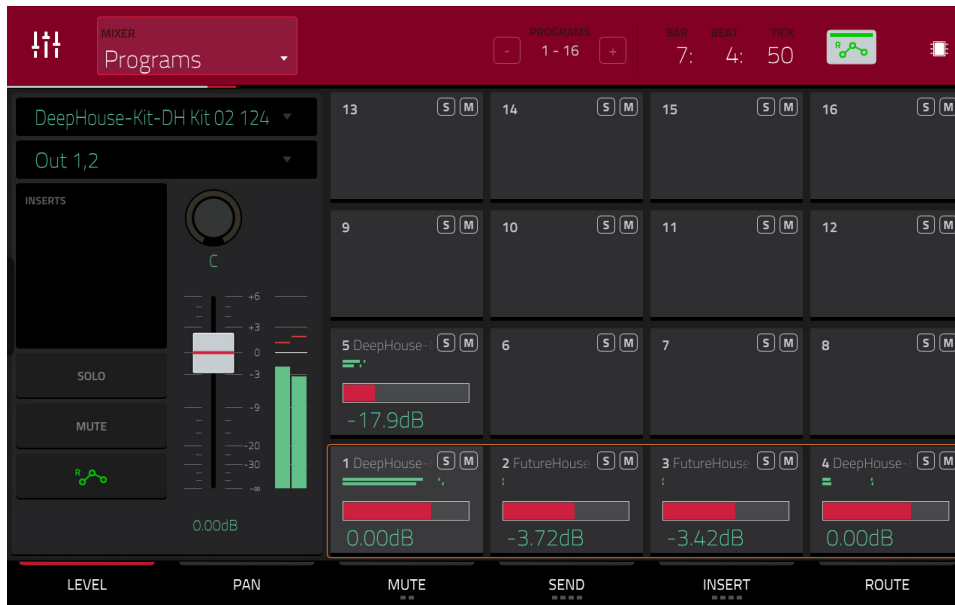

The Program Mixer shows levels, panning, mute states, send and insert effects, and routing for all programs.

**To view a specific setting on all programs**, tap **Level**, **Pan**, **Mute/Solo**, **Send**, **Insert**, or **Route** at the bottom of the screen. Tap **Mute/Solo** to switch between them. Tap **Send** or **Insert** to cycle through the four available slots for each.

When a program is selected, you can view and adjust all of its settings in the left side of the screen rather than using the tab buttons at the bottom.

When viewing the program channel strip:

**Note:** This is the same as the program channel strip in Main Mode.

The first field shows the current program number and name (which you can change).

The second field shows where the program is routed, which you can change: **Out 1,2-7,8** or **Out 1-8** in Standalone Mode, **Out 1,2-31,32** or **Out 1-32** in Controller Mode. You can also select a submix (**Sub 1-8**) in Controller Mode.

**Note:** When set to a mono channel, the left and right channels are summed post-pan knob. If the pan knob is set to the center position, the left and right channels will be summed and padded. If the pan knob is set to the maximum left or right positions, only the respective channel will be sent to the output.

The **Inserts** field shows any enabled or disabled effects for that program. Tap the area under **Inserts** to open a window where you can load, change, and enable or disable the effects for all four insert slots.

Tap **Solo** or **Mute** to solo or mute the program (respectively).



Tap the **automation button** to toggle between its two states. Alternatively, press **Read/Write** (MPC X, MPC Key 61) or **Automation** (MPC Key 37).

When set to **Read (R)**, the program will read automation data but will not record any additional automation over it. (Think of this as a protective feature to prevent accidental changes to your automation while recording.)



When set to **Write (W)**, the program can record automation. (If you have any Q-Link knobs assigned to automatable parameters, make sure not to touch any accidentally while you are recording.)



Press and hold **Shift** and tap the **automation button** to disable program automation. Alternatively, press **Shift+Read/Write** (MPC X, MPC Key 61) or **Shift+Automation** (MPC Key 37). When **off**, the program will ignore automation data. Tap the **program automation button** (or press **Read/Write** [MPC X, MPC Key 61] or **Automation** [MPC Key 37]) to enable program automation again.



**Important:** If you have already recorded automation and turn it off, the track will still use the effect and its parameter values at the point where you turned it off.

**Tip:** You can quickly set all programs and audio tracks to the same automation by tapping the global automation button in the upper-right corner of the screen. See [General Features > Automation](#) to learn about this.

Adjust the **pan knob** or **level slider** to change the panning or level of the program.

## Returns

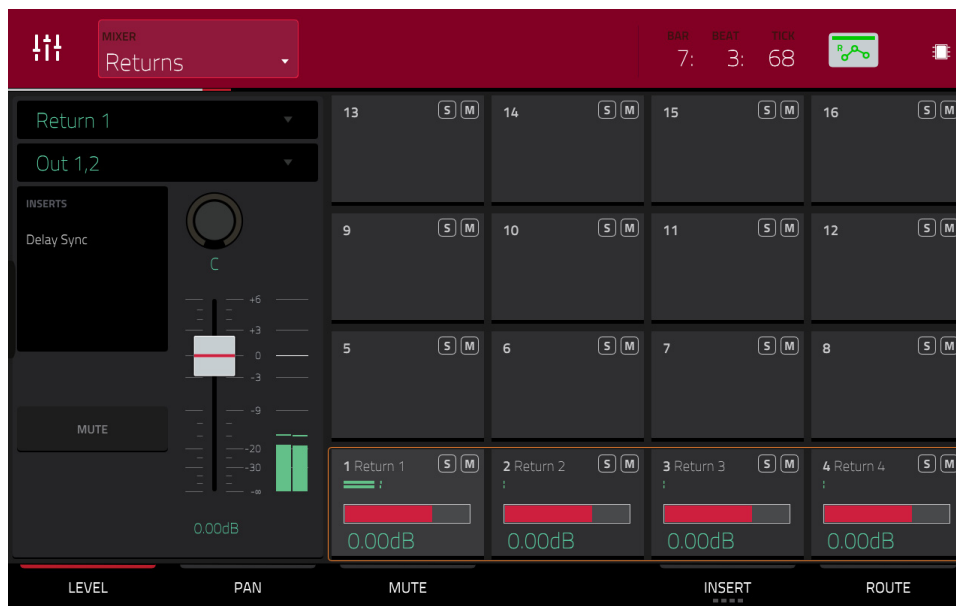

Pads, programs, and audio tracks can each be sent to up to four send channels. Their audio signals will be routed to the send channels at their designated send levels. After being processed by the effects on those channels, their signals are then sent to the assigned main output based on their return settings (levels, panning, etc.). This view displays the four return channels. The return mixer shows levels, panning, mute states, insert effects, and routing for all used tracks.

**To view a specific setting on all returns**, tap **Level**, **Pan**, **Mute**, **Insert**, or **Route** at the bottom of the screen. You can tap **Insert** multiple times to cycle through the four available slots.

When a return is selected, you can view and adjust all of its settings in the left side of the screen rather than using the tab buttons at the bottom.

When viewing the return channel strip:

The first field shows the current return number (which you can change).

The second field shows where the return is routed, which you can change: **Out 1,2–7,8** or **Out 1–8** in Standalone Mode; **Out 1,2–31,32** or **Out 1–32** in Controller Mode (MPC Live/MPC Live II do not use Out 7,8, and MPC One/MPC Key 61/MPC Key 37 do not use Out 3,4–7,8 in Standalone Mode, but displays them to maintain compatibility with MPC X, which does use them).

**Note:** When set to a mono channel, the left and right channels are summed post-pan knob. If the pan knob is set to the center position, the left and right channels will be summed and padded. If the pan knob is set to the maximum left or right positions, only the respective channel will be sent to the output.

The **Inserts** field shows any enabled or disabled effects for that return. Tap the area under **Inserts** to open a window where you can load, change, and enable or disable the effects for all four insert slots.

Tap **Mute** to mute the return.

Adjust the **pan knob** or **level slider** to change the panning or level of the return.

## Submixes

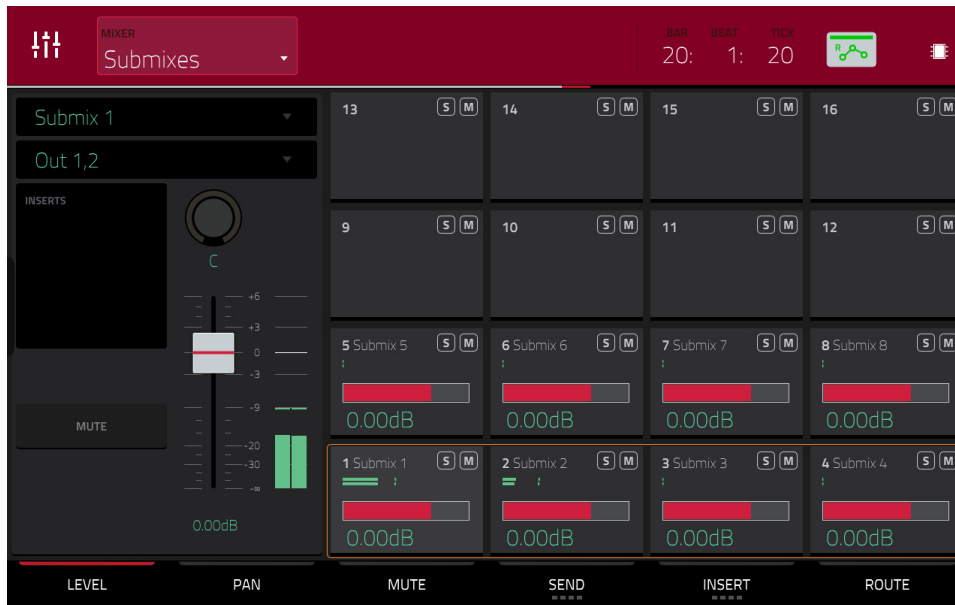

The Submixer shows levels, panning, mute states, send and insert effects, and routing for the eight available submixes.

**To view a specific setting on all submixes**, tap **Level**, **Pan**, **Mute**, **Send**, **Insert**, or **Route** at the bottom of the screen. You can tap **Send** or **Insert** multiple times to cycle through the four available slots for each.

When a submix is selected, you can view and adjust all of its settings in the left side of the screen rather than using the tab buttons at the bottom.

When viewing the submixer channel strip:

The first field shows the current submix (which you can change).

The second field shows where the submix is routed, which you can change: **Out 1,2–31,32** or **Out 1–32**.

**Note:** When set to a mono channel, the left and right channels are summed post-pan knob. If the pan knob is set to the center position, the left and right channels will be summed and padded. If the pan knob is set to the maximum left or right positions, only the respective channel will be sent to the output.

The **Inserts** field shows any enabled or disabled effects for that submix. Tap the area under **Inserts** to open a window where you can load, change, and enable or disable the effects for all four insert slots.

Tap **Mute** to mute the submix.

Adjust the **pan knob** or **level slider** to change the panning or level of the submix.

## Main Outputs

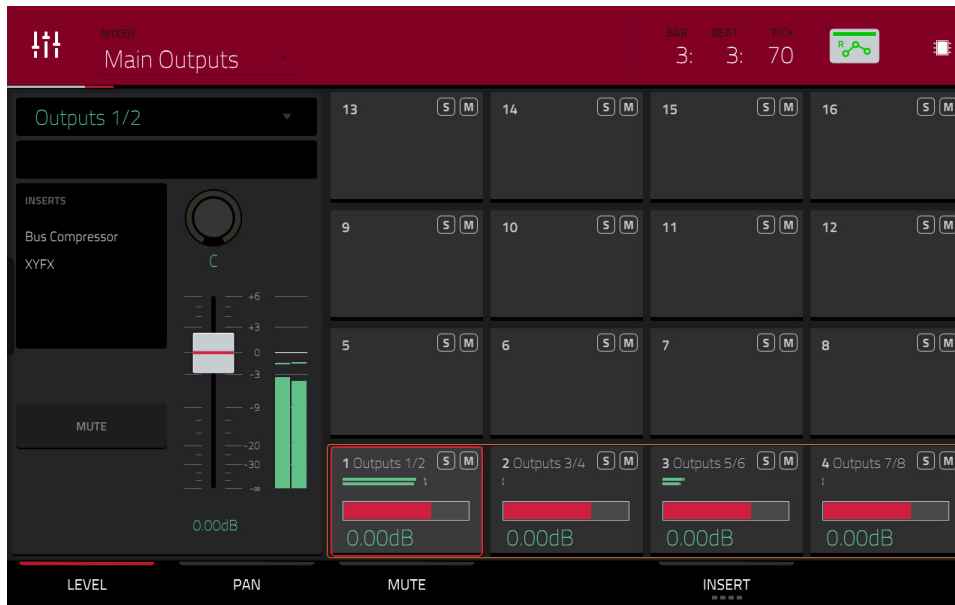

The Main Outputs Mixer shows levels, panning, mute states, and insert effects for all used stereo pairs of outputs (**Out 1,2–7,8** in Standalone Mode, **Out 1,2–31,32** in Controller Mode; MPC Live/MPC Live II do not use Out 7,8 and MPC One/MPC Key 61/MPC Key 37 do not use Out 3,4–7,8 in Standalone Mode, but displays them to maintain compatibility with MPC X, which does use them).

**To view a specific setting on all outputs**, tap **Level**, **Pan**, **Mute**, or **Insert** at the bottom of the screen. You can tap **Insert** multiple times to cycle through the four available slots.

When viewing the main output channel strip:

**Note:** This is the same as the main output channel strip in Main Mode.

The first field shows the current main output (which you can change).

The **Inserts** field shows any enabled or disabled effects for that main output. Tap the area under **Inserts** to open a window where you can load, change, and enable or disable the effects for all four insert slots.

Tap **Mute** to mute that main output.

Adjust the **pan knob** or **level slider** to change the panning or level of the main output.

## Pad Mute Mode



Pad Mute Mode lets you easily mute pads within a program or set mute groups for each pad within a program.

To enter **Pad Mute Mode**, do either of the following:

- Press **Menu**, and then tap **Pad Mute**.
- Press **Shift+Track Mute/Pad Mute** (MPC X, MPC One, MPC Key 37), or **Shift+Mute/Pad** (MPC Key 61).
- Press **Pad Mute** (MPC Studio).

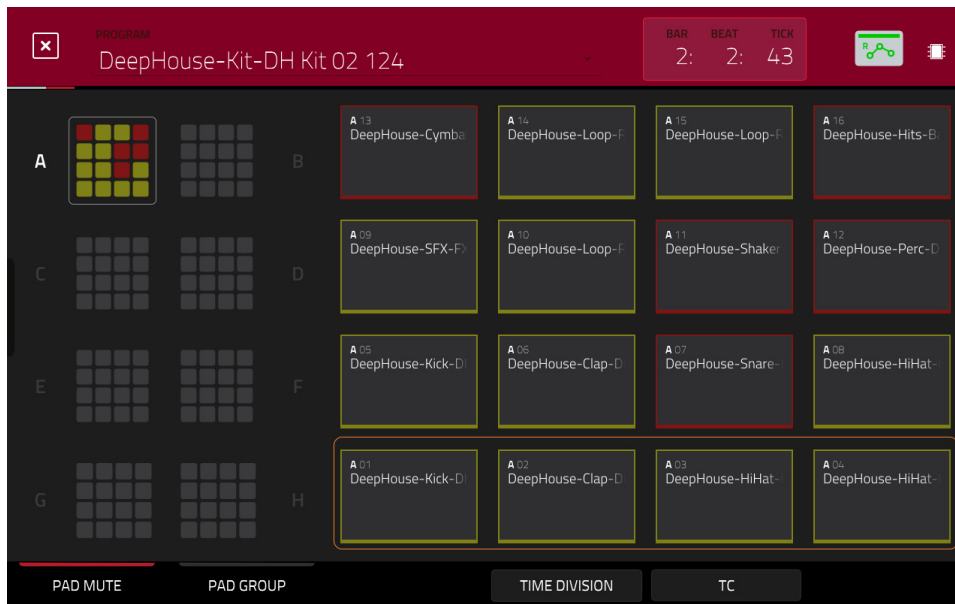

There are two tabs you can view in this mode: **Pad Mute** or **Pad Group**. Tap each button in the lower-left corner to select it. See the following [Pad Mute](#) and [Pad Group](#) sections to learn about each.

Use the **Program** field at the top of the screen to select a program.

The time counter in the upper-right corner shows the current playhead position. This is shown in most of the modes. See [General Features > Time Counter/Locate](#) to learn about this.

The automation button indicates the global automation state. This is shown in several modes. See [General Features > Automation](#) to learn about this.

**Time Correct** lets you quantize pad mutes. This is useful when you want your mutes to line up with a specific time division. For example, with **Time Division** set to **1 Bar**, your mutes will always align with the beginning of the measure immediately after you press the pad.

Tap **Time Division** at the bottom of the screen, and select a value from **1/16** to **2 Bars** (T indicates a triplet-based time division).

Tap **TC** at the bottom of the screen to enable or disable the Time Correct feature.

## Pad Mute

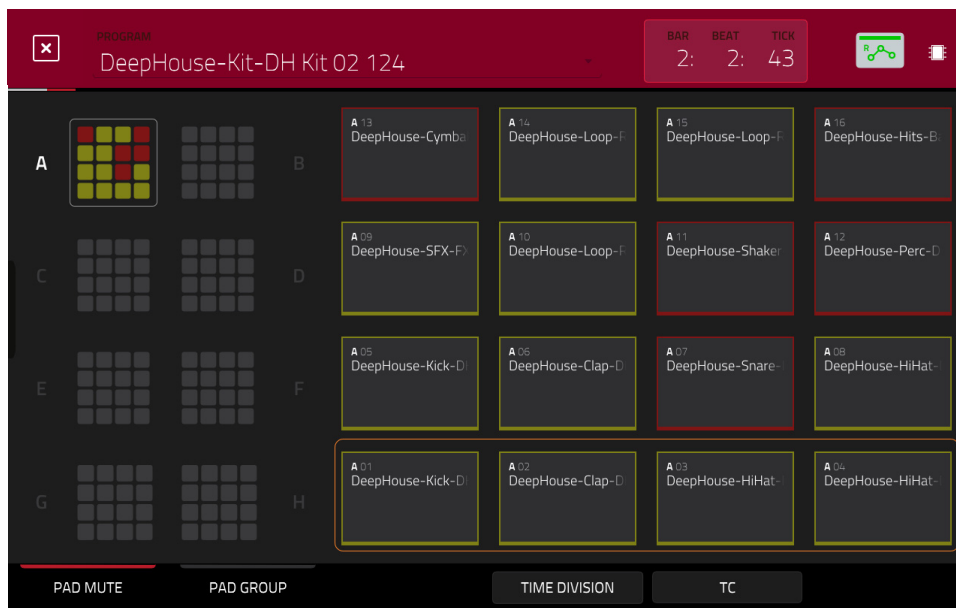

You can mute or unmute individual sounds (on a single track) in real time by pressing the pads. This is useful if you want to hear a track without a particular sound or if you want to isolate specific sounds or combinations of sounds.

**Tip:** This function is similar to muting pads one at a time in the grid—but more convenient.

### To mute pads in this mode:

1. If the **Pad Mute** tab in the lower-left corner is not already selected, tap it.
2. Select the desired pad bank. Use the **Pad Bank Buttons** or tap a pad bank shown on the left side of the screen.
3. **To mute or unmute a pad's sound**, press it or tap it on the screen. Muted pads are lit **red**. Unmuted pads are lit **yellow**. Unused pads do not show any sample names.

**To assign pads to pad groups within this tab**, turn each of the **Q-Link knobs** (when the **Screen Control Q-Link** button is selected) to assign each of the pads to a pad group. The number of each pad's group is shown in its upper-right corner.



## Track Mute Mode

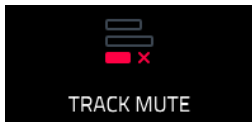

Track Mute Mode lets you easily mute tracks within a sequence or set track groups, enabling you to mute multiple tracks at once.

To enter **Track Mute Mode**, do either of the following:

- Press **Menu**, and then tap **Track Mute**.
- Press **Track Mute** (MPC X, MPC One, MPC Key 37), or press **Mute** (MPC Key 61).
- Press and hold **Shift** and press **Pad Mute** (MPC Studio).

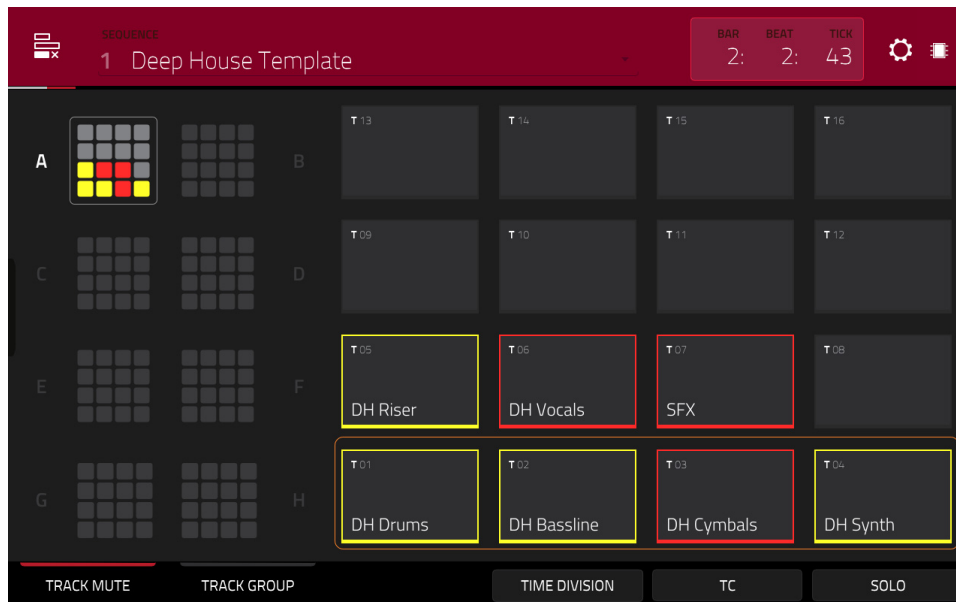

There are two tabs you can view in this mode: **Track Mute** or **Track Group**. Tap each button in the lower-left corner to select it. See the following [Track Mute](#) and [Track Group](#) sections to learn about each.

Use the **Sequence** field at the top of the screen to select a sequence.

The time counter in the upper-right corner shows the current playhead position. This is shown in most of the modes. See [General Features > Time Counter/Locate](#) to learn about this.

**Time Correct** lets you quantize track mutes. This is useful when you want your mutes to line up with a specific time division. For example, with **Time Division** set to **1 Bar**, your mutes will always align with the beginning of the measure immediately after you press the pad.

Tap **Time Division** at the bottom of the screen, and select a value from **1/16** to **2 Bars** (**T** indicates a triplet-based time division).

Tap **TC** at the bottom of the screen to enable or disable the Time Correct feature.

Tap **Solo** to turn track soloing on or off. When on, using Track Mute Mode will solo tracks instead of muting them.



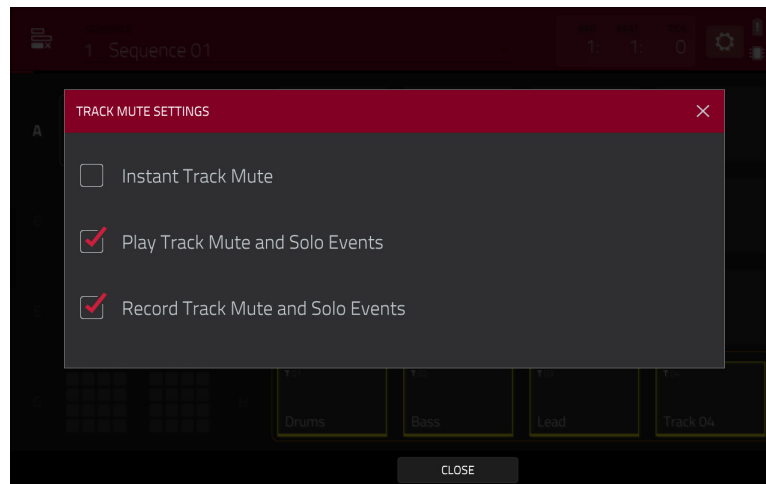

Tap the **gear icon** to open the Track Mute Settings window.

Check the **Instant Track Mute** box to instantly mute all audio on a track when mute is enabled. When unchecked, any sustained sounds will continue to play when mute is enabled.

Check the **Play Track Mute and Solo Events** to play back track muting and soloing recorded with automation.

Check the **Record Track Mute and Solo Events** to capture track muting and soloing when recording automation.

## Track Mute

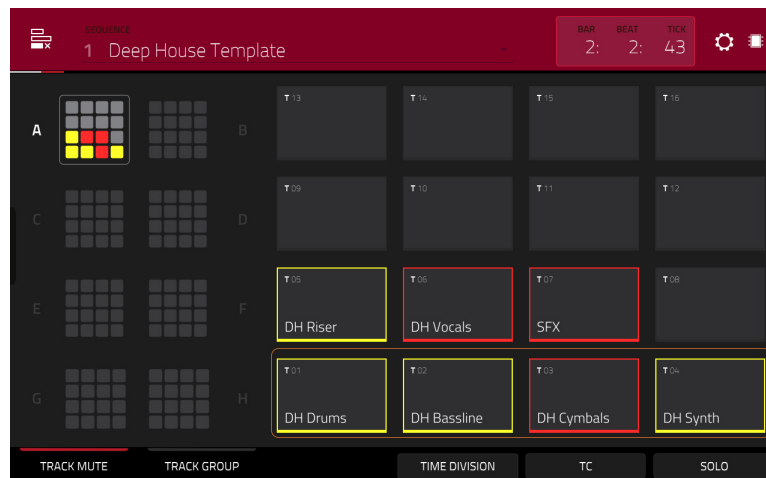

This is useful if you want to hear a sequence without a particular track (e.g., muting your keyboard track to focus on the bass) or if you want to isolate specific sounds or combinations of sounds that are separated by track.

**Tip:** This function is similar to, but more convenient than, muting tracks one at a time in the Track View.

### To mute tracks in this mode:

1. If the **Track Mute** tab in the lower-left corner is not already selected, tap it.
2. Select the desired pad bank. Use the **Pad Bank** buttons or tap a pad bank shown on the left side of the screen.
3. **To mute or unmute a track**, press the corresponding **pad** or tap it on the screen. Pads for muted tracks are lit **red**. Pads for unmuted tracks are lit **yellow**. Pads for unused tracks do not show any information.

**To assign tracks to track groups within this tab**, turn each of the **Q-Link knobs** (when the **Screen Control Q-Link** button is selected) to assign each of the pads to a track group. The number of each pad's track group is shown in its upper-right corner.

## Track Group

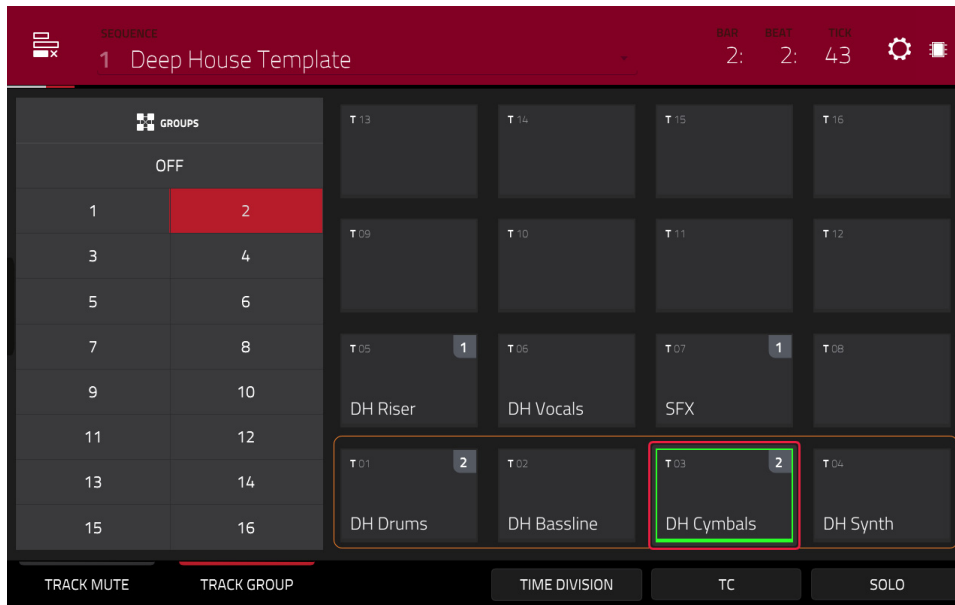

The track group feature extends the concept of track mutes: you can mute or unmute multiple tracks (in a single sequence) by pressing one pad that you have assigned to a track group. This is useful if you want to hear a track without a particular group of sounds or if you want to isolate specific sounds in various combinations. You can create up to 16 different track groups.

### To assign tracks to track groups:

1. If the **Track Group** tab in the lower-left corner is not already selected, tap it.
2. Select the desired pad bank by using the **Pad Bank** buttons.
3. **To select a track to add to a mute group**, press the corresponding **pad** or tap it on the screen. The pad for the selected track is lit **green**. If there are other pads for tracks in the same mute group, they will flash **yellow**.
4. **To add the track to a mute group**, tap the number of the desired mute group.

**To remove the track from the mute group**, tap **Off**.

Alternatively, turn each of the **Q-Link knobs** (when the **Screen Control Q-Link** button is selected) to assign each of the pads to a track group. The number of each pad's track group is shown in its upper-right corner.

## Next Sequence Mode

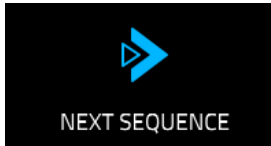

Next Sequence Mode lets you trigger different sequences simply by playing the pads. This is useful for live performances, letting you change a song's structure in real time.

To enter **Next Sequence Mode**, do either of the following:

- Press **Menu**, and then tap **Next Sequence**.
- Press **Next Seq** (MPC X, MPC Live II, MPC One).
- Press and hold **Mode** and press **Pad 9** (MPC Studio).

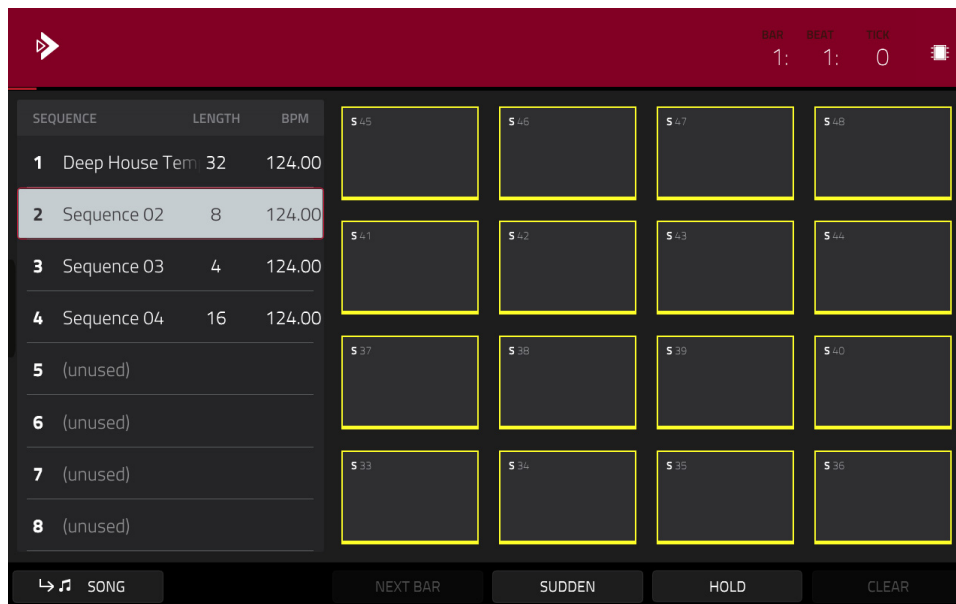

The time counter in the upper-right corner shows the current playhead position. This is shown in most of the modes. See [General Features > Time Counter/Locate](#) to learn about this.

The sequence playlist on the left side shows a list-style overview of **all** used sequences in your project:

The **Sequence** column shows the name of the song's sequences.

The **Length** column shows the bar length of a sequence.

The **BPM** column shows the tempo of a sequence in beats per minute.

The currently selected sequence is highlighted in the list. Tap a sequence in the list to select it.

| SEQUENCE         | LENGTH | BPM    |
|------------------|--------|--------|
| 1 Deep House Tem | 32     | 124.00 |
| 2 Sequence 02    | 8      | 124.00 |
| 3 Sequence 03    | 4      | 124.00 |
| 4 Sequence 04    | 16     | 124.00 |
| 5 (unused)       |        |        |
| 6 (unused)       |        |        |
| 7 (unused)       |        |        |
| 8 (unused)       |        |        |

In Next Sequence Mode, every pad is assigned to a sequence, starting from **Pad A01** with **Sequence 1** and ascending from there. The pads will show the names of their corresponding sequences. Empty pads correspond to unused sequences. The currently selected pad will flash **green**.

During playback, change the next sequence that will play by pressing the corresponding pad or tapping it on the screen. If you do not select another sequence, the current sequence will repeat indefinitely.



As a sequence plays, you can use the buttons at the bottom of the screen to change how playback works:

**To switch to the currently selected sequence at the beginning of the next bar**, tap **Next Bar**. This is useful if you want to switch to another sequence before the current one ends without having to worry about timing issues.

**To switch to the currently selected sequence immediately**, tap **Sudden**. The new sequence will start playing whether or not the current sequence is done. This is useful in live performances if you need to switch to the next sequence instantly at a certain cue.

**To delete the currently selected sequence from the sequence playlist**, tap **Clear**. This option is available only if that sequence is not playing at that moment.

**To repeat the current sequence indefinitely and temporarily ignore pad presses**, tap **Hold**. **To return to normal operation**, tap it again. This is useful if you want to select other pads without selecting them to play next.

**To copy the sequence playlist to a song**, tap ↵ **Song** while playback is stopped.

In the **Copy to Song** screen that appears, select a song, and then tap **Do It** to continue or **Close** to cancel.

To read more about Song Mode, please see the [Song Mode](#) chapter.

## Song Mode



SONG

Song Mode lets you arrange sequences in a specific order and/or repetition to create songs. You can edit the structure of a song during playback for easy, on-the-fly composing.

A project can contain up to 32 songs, each consisting of up to 999 “steps.” Each step can have an assigned sequence as well as the number of times that sequence will repeat.

To open **Song Mode**, do either of the following:

- Press **Menu**, and then tap **Song Mode**.
- Press **Shift+Next Seq/Song** (MPC X).
- Press and hold **Mode** and press **Pad 10** (MPC Studio).

**Important:** If a sequence is currently playing, stop playback before entering Song Mode. You cannot enter Song Mode during playback.

**Important:** When creating a song, the program used by each track in the song’s **first sequence** will be used by **all subsequent tracks**. In other words, all identically numbered tracks (across sequences) will use the program used by the first sequence in the song—regardless of what programs each track uses while not in Song Mode.

For example, if you create a project in this way…:

Track 1 of **Sequence 1** uses a **drum** program.

Track 1 of **Sequence 2** uses a **keygroup** program.

A song uses Sequence 1 as its first sequence and then uses Sequence 2 any time after it.

…then, in that song, Track 1 in Sequence 2 will use the same drum program as Track 1, Sequence 1.

Because of this, we recommend trying to be consistent while creating tracks in sequences that you intend to use in a single song. Remember that you can copy one track to another if you ever need to reorder the tracks of a sequence (see [Modes > Main Mode > Track Section](#) to learn about this).

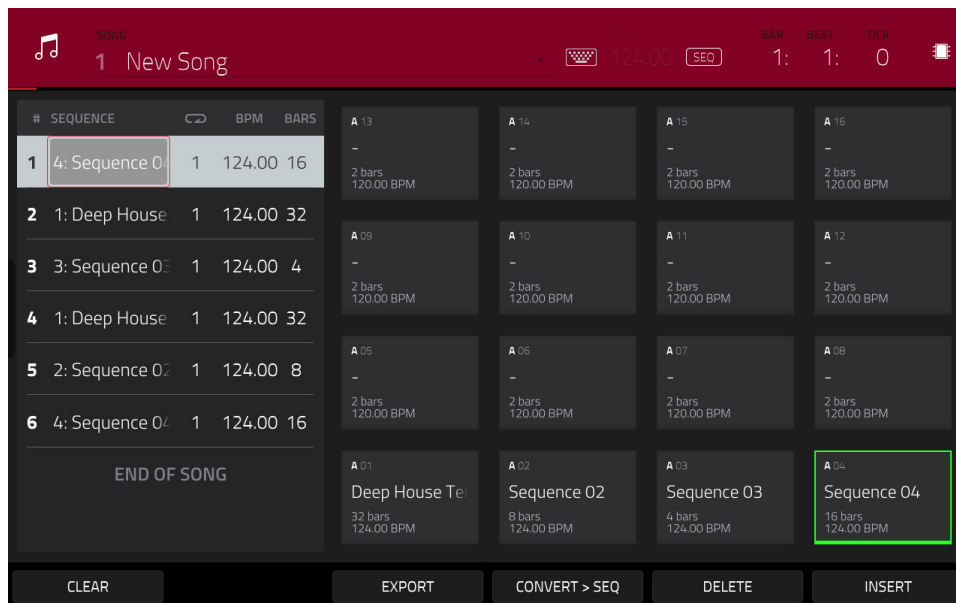

Use the **Song** field to select the song you want to show.

Use the **BPM** field to adjust the tempo of the sequence.

To set whether the sequence follows its own tempo (**Seq**) or a global tempo (**Gbl**), tap the **Seq/Gbl** button next to the BPM field. Alternatively, press **Shift+Tap/Master**.

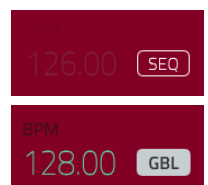

The sequence playlist on the left lists of the “steps” of a song.

Each step has (in columns, left to right):

- the step number (each song can contain up to 999 steps)
- a sequence number and name
- how many times the sequence plays (each step can play up to 999 times; set it to **Hold** [the lowest/minimum value] to set the sequence to repeat indefinitely until you stop playback)
- the tempo of the sequence
- the number of bars the step occupies (based on how many times it plays)

| #           | SEQUENCE       |   | BPM    | BARs |
|-------------|----------------|---|--------|------|
| 1           | 4: Sequence 01 | 1 | 124.00 | 16   |
| 2           | 1: Deep House  | 1 | 124.00 | 32   |
| 3           | 3: Sequence 03 | 1 | 124.00 | 4    |
| 4           | 1: Deep House  | 1 | 124.00 | 32   |
| 5           | 2: Sequence 02 | 1 | 124.00 | 8    |
| 6           | 4: Sequence 04 | 1 | 124.00 | 16   |
| END OF SONG |                |   |        |      |

Each used sequence is assigned to a pad. Empty pads correspond to unused sequences. Use the **Pad Bank** buttons to access the sequences assigned to pads in other banks.

|                      |                      |                      |                      |
|----------------------|----------------------|----------------------|----------------------|
| A 05<br>-            | A 06<br>-            | A 07<br>-            | A 08<br>-            |
| 2 bars<br>126.00 BPM | 2 bars<br>126.00 BPM | 2 bars<br>126.00 BPM | 2 bars<br>126.00 BPM |
| A 01<br>Sequence 01  | A 02<br>Sequence 02  | A 03<br>Sequence 03  | A 04<br>Sequence 04  |
| 2 bars<br>126.00 BPM | 2 bars<br>126.00 BPM | 2 bars<br>126.00 BPM | 2 bars<br>126.00 BPM |

| #           | SEQUENCE       |   | BPM    | BARs |
|-------------|----------------|---|--------|------|
| 1           | 4: Sequence 01 | 1 | 124.00 | 16   |
| 2           | 1: Deep House  | 1 | 124.00 | 32   |
| 3           | 3: Sequence 03 | 1 | 124.00 | 4    |
| 4           | 1: Deep House  | 1 | 124.00 | 32   |
| 5           | 2: Sequence 02 | 1 | 124.00 | 8    |
| 6           | 4: Sequence 04 | 1 | 124.00 | 16   |
| END OF SONG |                |   |        |      |

|                       |                      |                      |                       |
|-----------------------|----------------------|----------------------|-----------------------|
| A 13<br>-             | A 14<br>-            | A 15<br>-            | A 16<br>-             |
| 2 bars<br>120.00 BPM  | 2 bars<br>120.00 BPM | 2 bars<br>120.00 BPM | 2 bars<br>120.00 BPM  |
| A 09<br>-             | A 10<br>-            | A 11<br>-            | A 12<br>-             |
| 2 bars<br>120.00 BPM  | 2 bars<br>120.00 BPM | 2 bars<br>120.00 BPM | 2 bars<br>120.00 BPM  |
| A 05<br>-             | A 16<br>-            | A 07<br>-            | A 18<br>-             |
| 2 bars<br>120.00 BPM  | 2 bars<br>120.00 BPM | 2 bars<br>120.00 BPM | 2 bars<br>120.00 BPM  |
| A 01<br>Deep House Te | A 02<br>Sequence 02  | A 03<br>Sequence 03  | A 04<br>Sequence 04   |
| 32 bars<br>124.00 BPM | 8 bars<br>124.00 BPM | 4 bars<br>124.00 BPM | 16 bars<br>124.00 BPM |

### To insert a step:

1. Tap a **step** in the sequence playlist after which you want to insert a step.
2. Tap **Insert** in the lower-right corner of the screen.

### Alternatively, “record” a song using the pads:

**Note:** The sequences or song will not play back as you use the pads to create your song in this way. Pressing the pads just enters their corresponding sequences as steps.

1. Press **Rec** or **Overdub** to “record-arm” the song.
2. Press or tap the **pad** that corresponds to the first sequence you want to use. That sequence will appear in the sequence playlist as the first step.
3. Repeat **Step 2** for each additional step you want to add to the sequence playlist. Press or tap a **pad** multiple times to add to the number of times it plays.
4. Press **Stop** to stop “recording.”

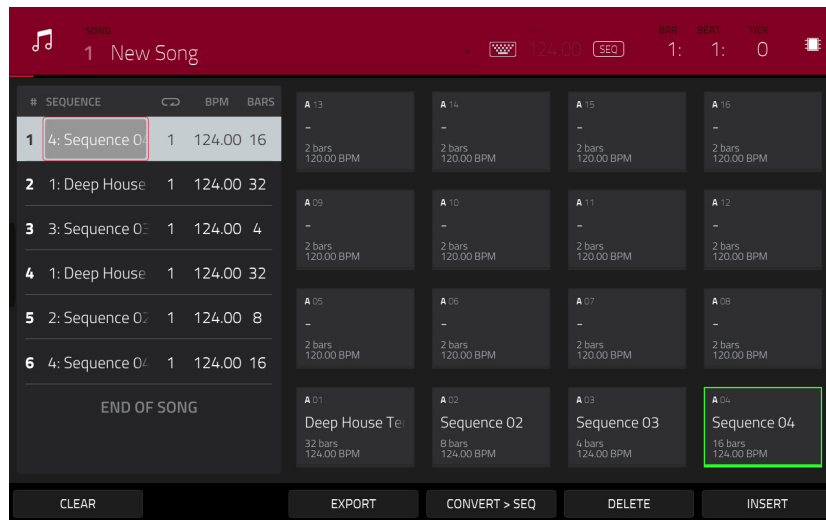

### To change a step's sequence:

1. In the desired step, tap the **sequence name**.
2. Use the **data dial** or **-/+** buttons to select another sequence.

**To delete a step**, tap it, and then tap **Delete** in the lower-right corner of the screen.

**To clear the entire sequence playlist** (delete all steps), tap **Clear**.

**To switch to the next sequence at the beginning of the next bar during playback**, tap **Next**. This is useful if you want to switch to another sequence before the current one ends without having to worry about timing issues.

**To switch to the next sequence immediately during playback**, tap **Sudden**. The new sequence will start playing whether or not the current sequence is done. This is useful in live performances if you need to switch to the next sequence instantly at a certain cue.

### To convert the current song to a single sequence:

1. Tap **Convert > Seq** to open the **Convert to Sequence** window.
2. Use the **To Sequence** field to select which sequence you want the song to export to.
3. Use the **Track Status** field to select whether you want the song to **Ignore Muted Tracks** or **Include Muted Tracks** in the new sequence.
4. **To confirm your selections**, tap **Do It**.  
**To cancel the process**, tap **Close**.

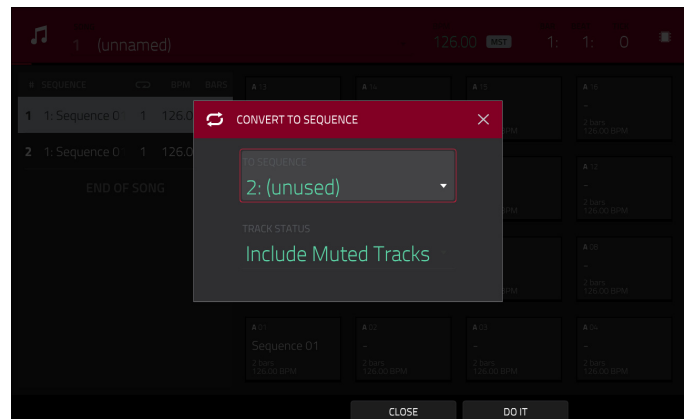

**To render/export your song as an audio file**, tap **Export** to open the **Audio Mixdown** screen. See [General Features > Audio Mixdown](#) to learn how to use this screen to export your song.

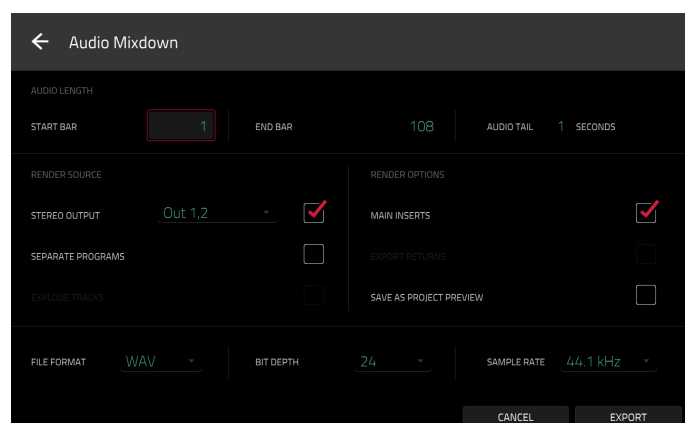

## Q-Link Edit Mode



Q-Link Edit Mode lets you determine what the Q-Link knobs control in other modes. This is helpful when you want to use the Q-Link knobs to control parameters that might not be shown in the current mode—or parameters that are shown across different modes.

To enter Q-Link Edit Mode, do any of the following:

- Press **Menu**, and then tap **Q-Link Edit**.
- Press **Shift+Screen Control/Edit** (MPC X), **Shift+Sample Edit/Q-Link Edit** (MPC One), or **Shift+Q-Link** (MPC Key 61, MPC Key 37).
- Press and hold one of the five **Q-Link** buttons above the **Q-Link knobs**, and then tap **Q-Link Edit** at the bottom of the window that appears (MPC X).

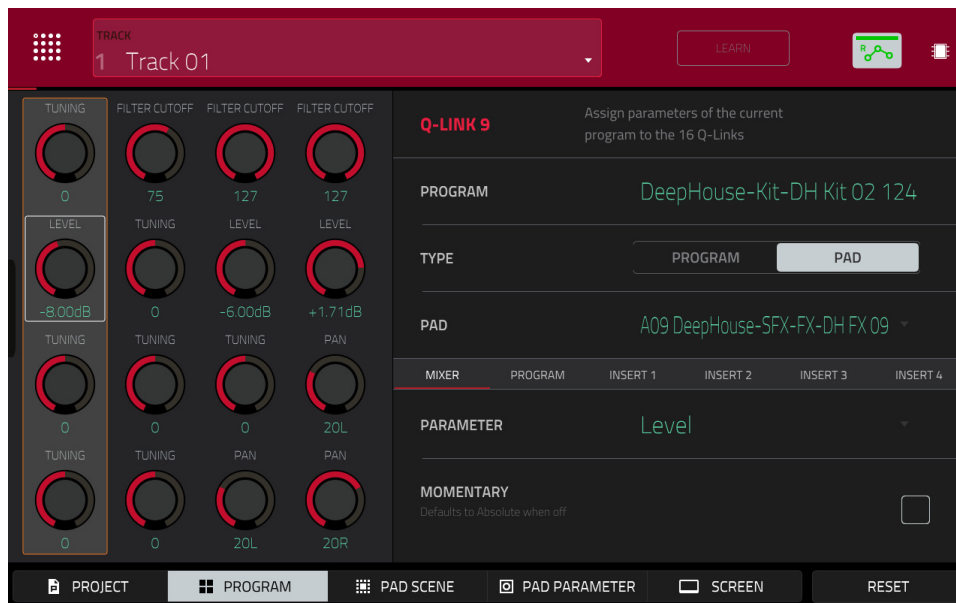

To select an edit mode for the Q-Link knobs, tap one of the five buttons at the bottom of the screen. If you are using MPC X, you can also press one of the five **Q-Link** buttons above the **Q-Link knobs** (**Project**, **Program**, **Pad Scene**, **Pad Param**, or **Screen Control/Edit**):

**Project:** In this edit mode, the Q-Link knobs can control 16 parameters within the current project overall. See the following [Project](#) section to learn about this specific Q-Link Edit Mode.

**Program/Audio Track:** In this edit mode, the Q-Link knobs can control 16 program or audio track parameters. See the following [Program/Audio Track](#) section to learn about this specific Q-Link Edit Mode.

**Pad Scene** (for drum programs only): In this edit mode, the Q-Link knobs can control 16 parameters for the currently selected pad. See the following [Pad Scene](#) section to learn about this specific Q-Link Edit Mode.

**Pad Parameter:** In this edit mode, the 16 Q-Link knobs correspond to the 16 pads, each one controlling the same parameter for each pad. This is useful if you need to adjust the same parameter on multiple pads at once rather than having to select and edit each pad individually. See the following [Pad Parameter](#) section to learn about this specific Q-Link Edit Mode.

**Screen:** In this edit mode, the Q-Link knobs will control a parameter or group of parameters in your currently selected mode (e.g., Main Mode, Sample Edit Mode, etc.).

Use the **Track** field to select a track that uses the desired program (and therefore pad/pads). The contents of the screen below will vary based on (1) the type of program each track uses and (2) the Q-Link Edit Mode you selected.



Tap the **Learn** button to turn Learn Mode on or off. When **on**, adjusting a control from your MPC touchscreen (in standalone mode or controller mode) or MPC software (in controller mode) will immediately assign it to the currently selected Q-Link knob.

This button is not available while in **Screen Q-Link Edit Mode** where the Q-Link knobs are unassignable.

#### To assign a function to a Q-Link knob in Learn Mode:

1. Tap **Learn** so the button is lit. (This will stop playback. Resuming playback will exit Learn Mode.)
2. Touch or turn the desired **Q-Link knob**.
3. In standalone mode, use the touchscreen to navigate to a **slider, knob**, or other control that you want to assign to the Q-Link knob, and then adjust it. Or, in controller mode, adjust a control in the MPC software or from your connected MPC hardware. The Q-Link knob will be able to control that parameter immediately.

**To assign functions to other Q-Link knobs**, repeat Steps 2–3.

**To exit Learn Mode**, tap **Learn** (or resume playback).

The automation button indicates the global automation state. This is shown in several modes. See [General Features > Automation](#) to learn about this.

At any time, in any mode, you can show the **Q-Links** window over the touchscreen's current contents. These are the same parameters and settings as what is shown in Q-Link Edit Mode.

**To show the Q-Links window**, press and hold any of the **Q-Link** buttons: **Project, Program, Pad Scene, Pad Param**, or **Screen Control/Edit** (MPC X) or the **Q-Link** button (MPC Live, MPC Live II, MPC One, MPC Key 61, MPC Key 37, MPC Touch).

**To close the Q-Links window**, release that **Q-Link** button.

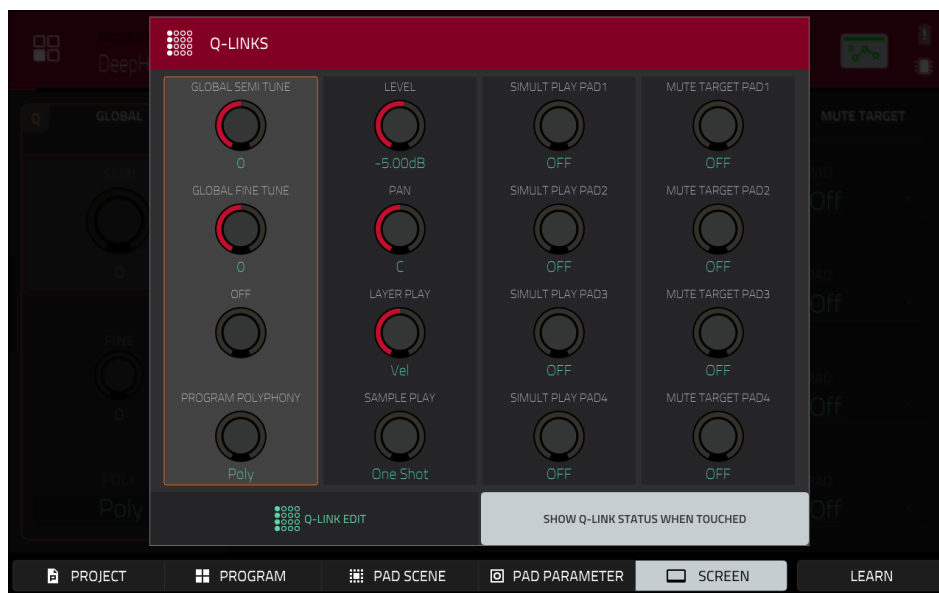

While the **Q-Links** window is shown:

**To adjust the settings of the selected knobs**, turn the corresponding **Q-Link knobs** on your MPC hardware.

**To select an edit mode for the Q-Link knobs**, tap one of the five buttons at the bottom of the screen. If you are using MPC X, you can also press one of the five **Q-Link** buttons above the **Q-Link knobs**: **Project, Program, Pad Scene, Pad Parameter**, or **Screen**.

**To turn Learn Mode on or off**, tap **Learn**. (This button is not available while in **Screen Q-Link Edit Mode** where the Q-Link knobs are unassignable.)

**To enter Q-Link Edit Mode immediately** (regardless of the current mode), tap **Q-Link Edit** at the bottom of the window.

**To enable or disable the Q-Link overlay**, tap **Show Q-Link Status When Touched** at the bottom of the window. A panel will appear on the right side of the touchscreen showing the available parameters being controlled and their values.

## Project

In the **Project** Q-Link Edit Mode, the Q-Link knobs control 16 parameters within the current project.

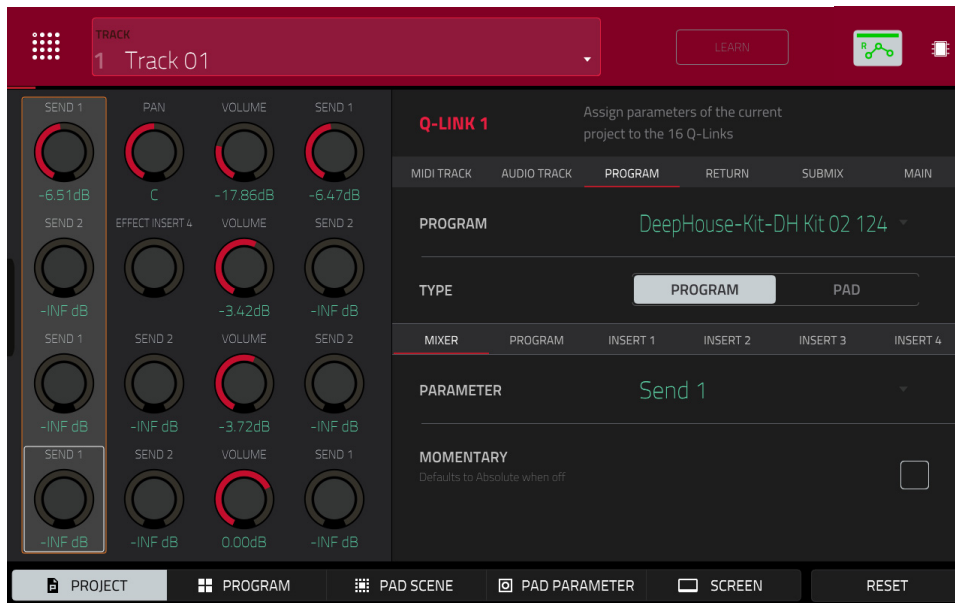

Next to the top row of Q-Link knobs on the screen, tap one of these tabs to select the type of parameters you want to control with the Q-Link knobs:

**MIDI Track:** MIDI track parameters. Use the **MIDI Track** field to select one of the MIDI tracks in your project.

**Audio Track:** audio track parameters. Use the **Audio Track** field to select one of the audio tracks in your project.

**Program:** program parameters. Use the **Program** field to select one of the programs in your project.

**Return:** return parameters. Use the **Return** field to select one of **Returns 1–4**.

**Submix:** submix parameters. Use the **Submix** field to select one of **Submixes 1–8**.

**Main:** main output parameters. Use the **Main** field to select one of the output pairs: **Outputs 1/2–7/8** in Standalone Mode or **Outputs 1/2–31/32** in Controller Mode (MPC Live/MPC Live II do not use Out 7,8 and MPC One/MPC Key 61/MPC Key 37 do not use Out 3,4–7,8 in Standalone Mode, but displays them to maintain compatibility with MPC X, which does use them).

Next to the second row of Q-Link knobs on the screen, tap one of these tabs to select the type of parameters you want to control with the Q-Link knobs:

**Mixer:** general mixer parameters

**Program** (in the **Program** tab if a drum program or clip program is selected): program parameters

**Insert 1–4** (not available in the **MIDI Track** tab or **Program** tab if a MIDI program is selected): parameters for its program insert effects

If the **Program** tab is selected, use the **Type** selector to determine whether the Q-Link knobs will control the parameters of the entire program (**Program**) or for a single pad (**Pad**).

**To select a program**, use the **Program** field next to the top row of Q-Link knobs on the screen.

**To select a pad** (if **Type** is set to **Pad**), use the **Pad** field.

Use the **Parameter** field to select the parameter you want to control with the currently selected Q-Link knob.

When the **MIDI Track** tab is selected:

**Mixer:** Off, Volume, Pan, Mute, Solo

When the **Audio Track** tab is selected:

**Mixer:** Off, Volume, Pan, Mute, Solo, Send 1–4

**Insert 1–4:** Off, other available parameters depend on the effect

When the **Program** tab is selected and **Type** is set to **Program**:

**Mixer:** Off, Volume, Pan, Mute, Solo, Send 1–4

**Program:** Off, Global Semi Tune, Global Fine Tune

**Insert 1–4:** Off, other available parameters depend on the effect

When the **Program** tab is selected and **Type** is set to **Pad**:

**Mixer:** Off, Level, Pan, Pad Mute, Pad Solo, Send 1–4

**Program:**

|                       |                          |                        |                               |
|-----------------------|--------------------------|------------------------|-------------------------------|
| Off                   | Filter Env Attack Curve  | Layer Semi Tune (1–4)  | Layer Reverse (1–4)           |
| Tuning                | Filter Env Decay Curve   | Layer Fine Tune (1–4)  | Layer Offset (1–4)            |
| Filter Cutoff         | Filter Env Release Curve | Velocity to Start      | Layer Loop Xfade (1–4)        |
| Filter Resonance      | Pitch Env Attack         | Vel to Filter Attack   | Layer Loop Xfade Type (1–4)   |
| Filter Env Amount     | Pitch Env Hold           | Velocity to Env Amount | Layer Slice Tail Length (1–4) |
| Amp Env Attack        | Pitch Env Decay          | Velocity to Filter     | Layer Slice Tail Start (1–4)  |
| Amp Env Decay         | Pitch Env Sustain        | LFO to Pitch           | Layer Pitch Random (1–4)      |
| Amp Env Release       | Pitch Env Release        | LFO to Filter          | Layer Level Random (1–4)      |
| Amp Env Hold          | Pitch Env Decay Mode     | LFO to Amp             | Layer Pan Random (1–4)        |
| Amp Env Sustain       | Pitch Env Attack Curve   | LFO to Pan             | Layer Offset Random (1–4)     |
| Filter Env Attack     | Pitch Env Decay Curve    | LFO Wave               | Attack Random                 |
| Filter Env Hold       | Pitch Env Release Curve  | LFO Rate               | Decay Random                  |
| Filter Env Decay      | Pitch Env Depth          | LFO Sync               | Cutoff Random                 |
| Filter Env Sustain    | Pitch Env Type           | Velocity to Pitch      | Resonance Random              |
| Filter Env Release    | DrumFX (1–8)             | Vel to Volume Attack   | Total Random Amount           |
| Amp Env Attack Curve  | DrumFX Type (1–8)        | Velocity to Amp        | LFO Level                     |
| Amp Env Decay Curve   | Layer Level (1–4)        | Velocity to Pan        | LFO Delay                     |
| Amp Env Release Curve | Layer Sample Pan (1–4)   | Layer Slice (1–4)      | LFO Fade In                   |

**Insert 1–4:** Off, other available parameters depend on the effect

When the **Return** tab is selected:

**Mixer:** Off, Volume, Pan, Mute

**Insert 1–4:** Off, other available parameters depend on the effect

When the **Submix** tab is selected:

**Mixer:** Off, Volume, Pan, Mute, Send 1–4

**Insert 1–4:** Off, other available parameters depend on the effect

When the **Main** tab is selected:

**Mixer:** Off, Volume, Pan, Mute

**Insert 1–4:** Off, other available parameters depend on the effect

Tap the **Momentary** checkbox to turn momentary behavior on or off.

When **on**, moving the Q-Link knob will adjust its parameter, but the parameter will immediately return to its original position (when you turned Momentary on) when you release the Q-Link knob.

When **off**, moving the Q-Link knob will adjust its parameter, and the parameter will remain at its new setting when you release the Q-Link knob.

## Program/Audio Track

In the **Program/Audio Track** Q-Link Edit Mode, the Q-Link knobs control 16 parameters within the currently selected program or audio track.

When a **MIDI track** is selected:

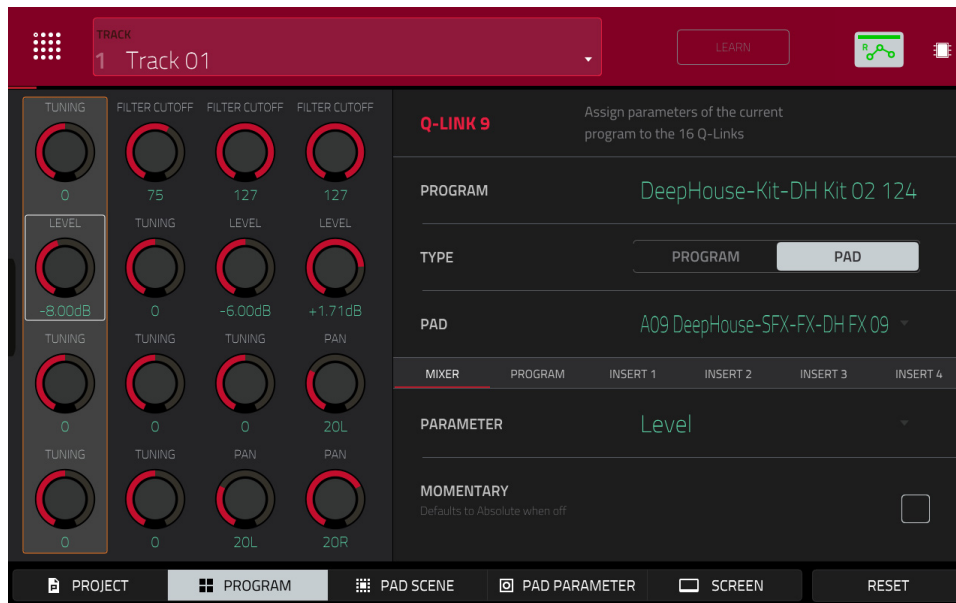

Next to the top row of Q-Link knobs on the screen, tap one of these tabs to select the type of parameters you want to control with the Q-Link knobs:

**Mixer:** general mixer parameters

**Program:** program parameters

**Insert 1–4:** parameters for its program insert effects

Use the **Type** selector to determine whether the Q-Link knobs will control the parameters of the entire program (**Program**) or for a single pad (**Pad**).

**To select a program,** use the **Track** field at the top of the screen to select a track that uses it. The program name will appear in the **Program** field next to the top row of Q-Link knobs on the screen.

**To select a pad** (if **Type** is set to **Pad**), use the **Pad** field.

Use the **Parameter** field to select the parameter you want to control with the Q-Link knobs.

When **Type** is set to **Program**:

**Mixer:** Off, Volume, Pan, Mute, Solo, Send 1–4

**Program:** Off, Global Semi Tune, Global Fine Tune

**Insert 1–4:** Off, other available parameters depend on the effect

When **Type** is set to **Pad**:

**Mixer:** Off, Level, Pan, Pad Mute, Pad Solo, Send 1–4

**Program:**

|                       |                          |                        |                               |
|-----------------------|--------------------------|------------------------|-------------------------------|
| Off                   | Filter Env Attack Curve  | Layer Semi Tune (1–4)  | Layer Reverse (1–4)           |
| Tuning                | Filter Env Decay Curve   | Layer Fine Tune (1–4)  | Layer Offset (1–4)            |
| Filter Cutoff         | Filter Env Release Curve | Velocity to Start      | Layer Loop Xfade (1–4)        |
| Filter Resonance      | Pitch Env Attack         | Vel to Filter Attack   | Layer Loop Xfade Type (1–4)   |
| Filter Env Amount     | Pitch Env Hold           | Velocity to Env Amount | Layer Slice Tail Length (1–4) |
| Amp Env Attack        | Pitch Env Decay          | Velocity to Filter     | Layer Slice Tail Start (1–4)  |
| Amp Env Decay         | Pitch Env Sustain        | LFO to Pitch           | Layer Pitch Random (1–4)      |
| Amp Env Release       | Pitch Env Release        | LFO to Filter          | Layer Level Random (1–4)      |
| Amp Env Hold          | Pitch Env Decay Mode     | LFO to Amp             | Layer Pan Random (1–4)        |
| Amp Env Sustain       | Pitch Env Attack Curve   | LFO to Pan             | Layer Offset Random (1–4)     |
| Filter Env Attack     | Pitch Env Decay Curve    | LFO Wave               | Attack Random                 |
| Filter Env Hold       | Pitch Env Release Curve  | LFO Rate               | Decay Random                  |
| Filter Env Decay      | Pitch Env Depth          | LFO Sync               | Cutoff Random                 |
| Filter Env Sustain    | Pitch Env Type           | Velocity to Pitch      | Resonance Random              |
| Filter Env Release    | DrumFX (1–8)             | Vel to Volume Attack   | Total Random Amount           |
| Amp Env Attack Curve  | DrumFX Type (1–8)        | Velocity to Amp        | LFO Level                     |
| Amp Env Decay Curve   | Layer Level (1–4)        | Velocity to Pan        | LFO Delay                     |
| Amp Env Release Curve | Layer Sample Pan (1–4)   | Layer Slice (1–4)      | LFO Fade In                   |

**Insert 1–4:** Off, other available parameters depend on the effect

Tap the **Momentary** checkbox to turn momentary behavior on or off.

When **on**, moving the Q-Link knob will adjust its parameter, but the parameter will immediately return to its original position (when you turned Momentary on) when you release the Q-Link knob.

When **off**, moving the Q-Link knob will adjust its parameter, and the parameter will remain at its new setting when you release the Q-Link knob.

When an **audio track** is selected:

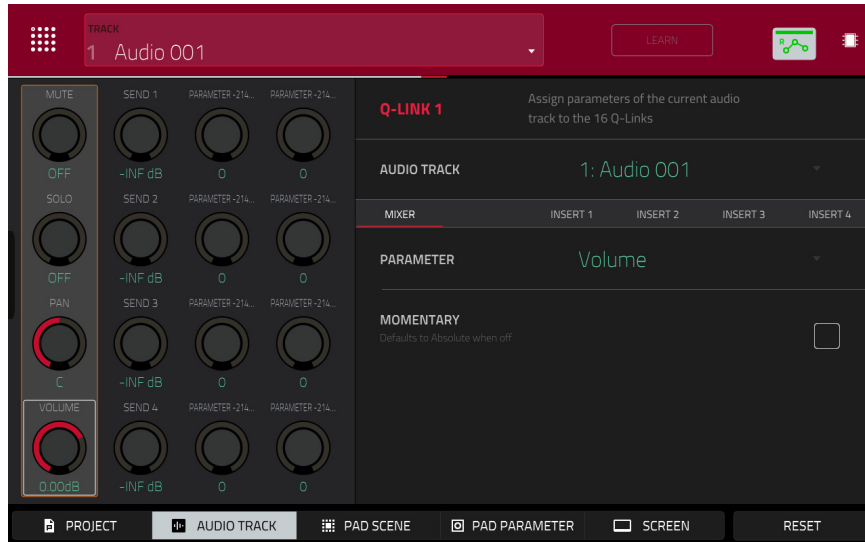

Next to the top row of Q-Link knobs on the screen, tap one of these tabs to select the type of parameters you want to control with the Q-Link knobs:

**Mixer:** general mixer parameters

**Insert 1–4:** parameters for its program insert effects

Use the **Parameter** field to select the parameter you want to control with the Q-Link knobs.

Tap the **Momentary** checkbox to turn momentary behavior on or off.

When **on**, moving the Q-Link knob will adjust its parameter, but the parameter will immediately return to its original position (when you turned Momentary on) when you release the Q-Link knob.

When **off**, moving the Q-Link knob will adjust its parameter, and the parameter will remain at its new setting when you release the Q-Link knob.

## Pad Scene

In the **Pad Scene** Q-Link Edit Mode, the Q-Link knobs control your favorite 16 parameters for the currently selected pad. You can select another pad simply by pressing it, allowing you to adjust the same 16 parameters for that new pad. (These assignments are automatically saved with other user settings. Any project you load will use these assignments.)

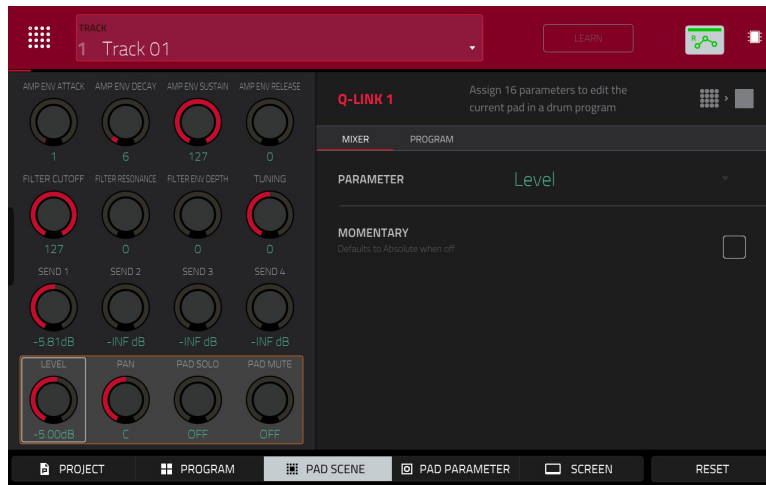

To select a pad, press it.

Next to the top row of Q-Link knobs on the screen, tap one of these tabs to select the type of parameters you want to control with the Q-Link knobs:

**Mixer:** general mixer parameters

**Program:** pad parameters (i.e., parameters used in Program Edit Mode)

Use the **Parameter** field to select the parameter you want to control with the Q-Link knobs.

**Mixer:** Off, Level, Pan, Pad Mute, Pad Solo, Send 1–4

**Program:**

|                       |                          |                        |                               |
|-----------------------|--------------------------|------------------------|-------------------------------|
| Off                   | Filter Env Attack Curve  | Layer Semi Tune (1–4)  | Layer Reverse (1–4)           |
| Tuning                | Filter Env Decay Curve   | Layer Fine Tune (1–4)  | Layer Offset (1–4)            |
| Filter Cutoff         | Filter Env Release Curve | Velocity to Start      | Layer Loop Xfade (1–4)        |
| Filter Resonance      | Pitch Env Attack         | Vel to Filter Attack   | Layer Loop Xfade Type (1–4)   |
| Filter Env Amount     | Pitch Env Hold           | Velocity to Env Amount | Layer Slice Tail Length (1–4) |
| Amp Env Attack        | Pitch Env Decay          | Velocity to Filter     | Layer Slice Tail Start (1–4)  |
| Amp Env Decay         | Pitch Env Sustain        | LFO to Pitch           | Layer Pitch Random (1–4)      |
| Amp Env Release       | Pitch Env Release        | LFO to Filter          | Layer Level Random (1–4)      |
| Amp Env Hold          | Pitch Env Decay Mode     | LFO to Amp             | Layer Pan Random (1–4)        |
| Amp Env Sustain       | Pitch Env Attack Curve   | LFO to Pan             | Layer Offset Random (1–4)     |
| Filter Env Attack     | Pitch Env Decay Curve    | LFO Wave               | Attack Random                 |
| Filter Env Hold       | Pitch Env Release Curve  | LFO Rate               | Decay Random                  |
| Filter Env Decay      | Pitch Env Depth          | LFO Sync               | Cutoff Random                 |
| Filter Env Sustain    | Pitch Env Type           | Velocity to Pitch      | Resonance Random              |
| Filter Env Release    | DrumFX (1–8)             | Vel to Volume Attack   | Total Random Amount           |
| Amp Env Attack Curve  | DrumFX Type (1–8)        | Velocity to Amp        | LFO Level                     |
| Amp Env Decay Curve   | Layer Level (1–4)        | Velocity to Pan        | LFO Delay                     |
| Amp Env Release Curve | Layer Sample Pan (1–4)   | Layer Slice (1–4)      | LFO Fade In                   |

Tap the **Momentary** checkbox to turn momentary behavior on or off.

When **on**, moving the Q-Link knob will adjust its parameter, but the parameter will immediately return to its original position (when you turned Momentary on) when you release the Q-Link knob.

When **off**, moving the Q-Link knob will adjust its parameter, and the parameter will remain at its new setting when you release the Q-Link knob.

## Pad Parameter

In the **Pad Parameter** Q-Link Edit Mode, the Q-Link knobs control the same pad parameter for the each of the 16 pads in the current pad bank.

For example, if the **Parameter** is set to **Level**, the 16 Q-Link knobs will adjust the 16 independent **Level** settings for each pad in the current pad bank. You could then set the **Parameter** to **Pan** and use the Q-Link knobs to adjust the panning of all 16 pads.

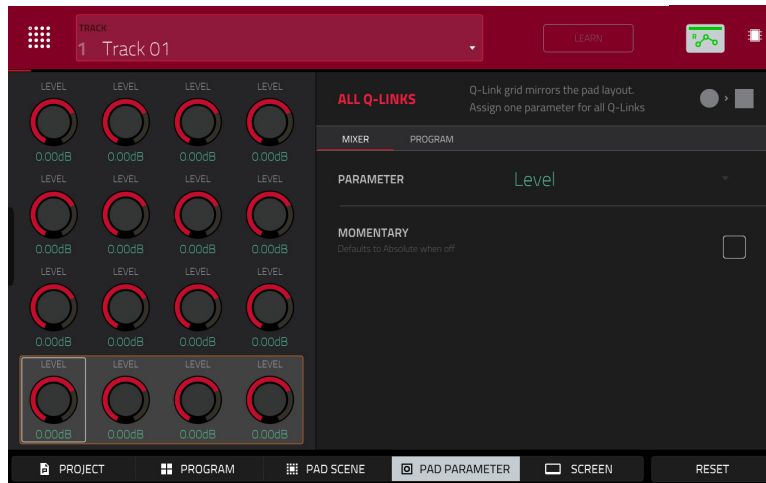

Next to the top row of Q-Link knobs on the screen, tap one of these tabs to select the type of parameter you want to control with the Q-Link knobs:

**Mixer:** general mixer parameters

**Program:** pad parameters (i.e., parameters used in Program Edit Mode)

Use the **Parameter** field to select the parameter you want to control with the Q-Link knobs.

**Mixer:** Off, Level, Pan, Pad Mute, Pad Solo, Send 1–4

**Program:**

|                       |                          |                        |                               |
|-----------------------|--------------------------|------------------------|-------------------------------|
| Off                   | Filter Env Attack Curve  | Layer Semi Tune (1–4)  | Layer Reverse (1–4)           |
| Tuning                | Filter Env Decay Curve   | Layer Fine Tune (1–4)  | Layer Offset (1–4)            |
| Filter Cutoff         | Filter Env Release Curve | Velocity to Start      | Layer Loop Xfade (1–4)        |
| Filter Resonance      | Pitch Env Attack         | Vel to Filter Attack   | Layer Loop Xfade Type (1–4)   |
| Filter Env Amount     | Pitch Env Hold           | Velocity to Env Amount | Layer Slice Tail Length (1–4) |
| Amp Env Attack        | Pitch Env Decay          | Velocity to Filter     | Layer Slice Tail Start (1–4)  |
| Amp Env Decay         | Pitch Env Sustain        | LFO to Pitch           | Layer Pitch Random (1–4)      |
| Amp Env Release       | Pitch Env Release        | LFO to Filter          | Layer Level Random (1–4)      |
| Amp Env Hold          | Pitch Env Decay Mode     | LFO to Amp             | Layer Pan Random (1–4)        |
| Amp Env Sustain       | Pitch Env Attack Curve   | LFO to Pan             | Layer Offset Random (1–4)     |
| Filter Env Attack     | Pitch Env Decay Curve    | LFO Wave               | Attack Random                 |
| Filter Env Hold       | Pitch Env Release Curve  | LFO Rate               | Decay Random                  |
| Filter Env Decay      | Pitch Env Depth          | LFO Sync               | Cutoff Random                 |
| Filter Env Sustain    | Pitch Env Type           | Velocity to Pitch      | Resonance Random              |
| Filter Env Release    | DrumFX (1–8)             | Vel to Volume Attack   | Total Random Amount           |
| Amp Env Attack Curve  | DrumFX Type (1–8)        | Velocity to Amp        | LFO Level                     |
| Amp Env Decay Curve   | Layer Level (1–4)        | Velocity to Pan        | LFO Delay                     |
| Amp Env Release Curve | Layer Sample Pan (1–4)   | Layer Slice (1–4)      | LFO Fade In                   |

Tap the **Momentary** checkbox to turn momentary behavior on or off.

When **on**, moving the Q-Link knob will adjust its parameter, but the parameter will immediately return to its original position (when you turned Momentary on) when you release the Q-Link knob.

When **off**, moving the Q-Link knob will adjust its parameter, and the parameter will remain at its new setting when you release the Q-Link knob.



## Screen

In the **Screen** Q-Link Edit Mode, the Q-Link knobs will control only the parameter or group of parameters in your currently selected mode (e.g., Main Mode, Sample Edit Mode, etc.).

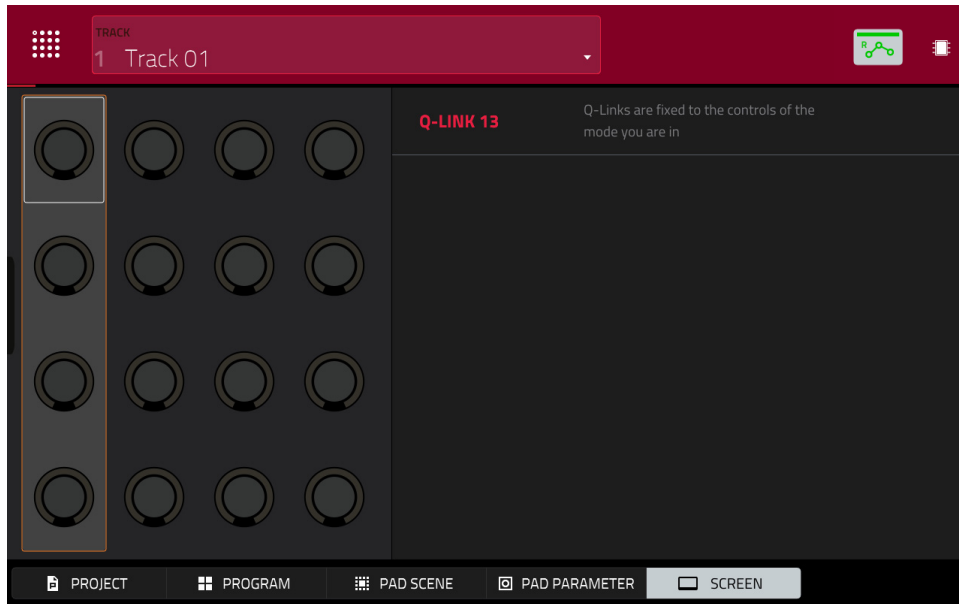

## Pad Color Mode

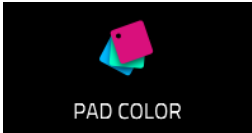

Pad Color Mode lets you assign specific colors to your pads in each program.

To enter **Pad Color Mode**, enter **Main** mode and tap the **pencil icon** in the **Program** section to open the edit options, and then tap **Pad Color**.

**Important:** If you are already in Pad Color Mode and want to assign pad colors for another program, exit Pad Color Mode first, and then select another track in Main mode that uses the desired program.

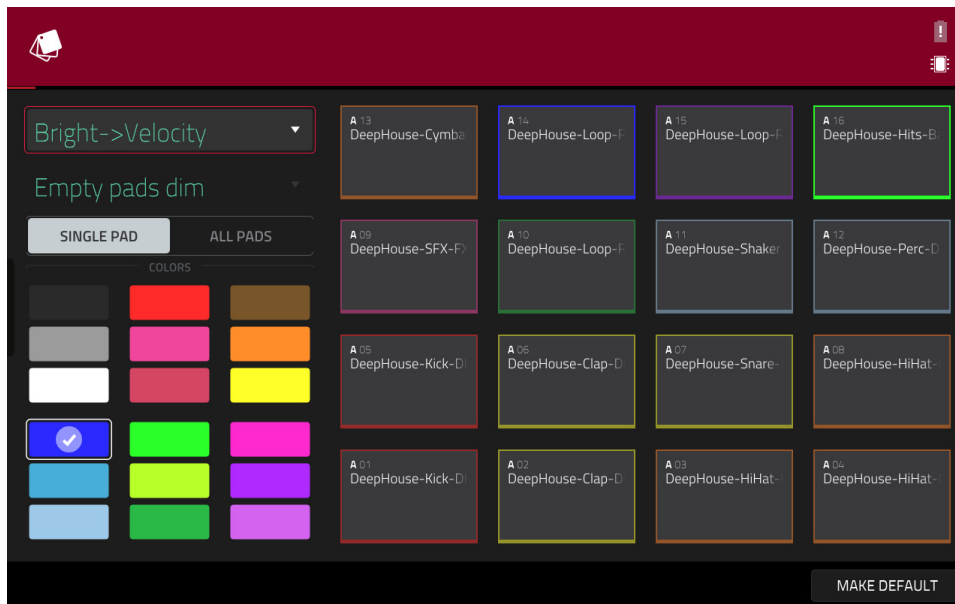

Use the field in the upper-left corner to set how the pad lights will display:

**Off:** The pads will be unlit whether you are playing them or not.

**Classic Velocity:** The pads will be unlit while you are not playing them. When you press them, they will light with colors according to the velocity: red indicates a high velocity, yellow indicates a low velocity.

**Fixed:** The pads will be lit with their assigned colors whether you are playing them or not.

**Off->Velocity:** The pads will be unlit when you are not playing them. When you press them, they will light with their assigned color with a brightness that corresponds with the velocity.

**Dim->Velocity:** The pads will be dimly lit when you are not playing them. When you press them, they will light with their assigned color with a brightness that corresponds with the velocity.

**Bright->Velocity:** The pads will be brightly lit when you are not playing them. When you press them, they will light with their assigned color with a brightness that corresponds with the velocity.

Use the **Empty Pads** field in the upper-left corner to set how empty pads will display:

**Empty pads off:** Pads without any sounds will remain off.

**Empty pads dim:** Pads without any sounds will remain more dimly lit than pads with sounds assigned.

**Empty pads normal:** Pads without any sounds will appear the same as pads with sounds assigned.

Use the **Single Pad/All Pads** select to determine whether you are setting the color for a **Single Pad** or **All Pads**.

**Tip: To quickly assign that color to all pads in the program,** press and hold **Shift** while tapping a color button.

Use the **color buttons** to select which color you are assigning.

**Tip: To select the color button corresponding a specific pad's color,** press and hold **Shift**, and then press the pad or tap it on the screen.

Press a **pad** on your MPC hardware or tap it on the screen to assign the selected color to it.

**To make the current pad color settings the defaults for all programs on the same type** (e.g., drum programs, keygroup programs, etc.), tap **Make Default**. In the window that appears, tap **Do It** to confirm your choice or **Cancel** to cancel.

## MIDI Control Mode



You can use MIDI Control Mode on your MPC hardware to customize what MIDI messages are sent from certain controls on your hardware. This custom “control map” will then work whenever you are in MIDI Control Mode. The edits you make in MIDI Control Mode will be retained with the current MPC project.

In Standalone Mode, this feature enables you to use your MPC hardware to control external MIDI devices connected to its MIDI out.

In Controller Mode, this is helpful when using MPC as a plugin: you can use MIDI Control Mode to use your MPC hardware to control your host software, and then switch back to any other mode to control the MPC plugin.

To enter **MIDI Control Mode**, do either of the following:

- Press **Menu**, and then tap **MIDI Control**.
- Press **Shift+Program Edit/MIDI Control** (MPC One), or press **Shift+Keyboard Control/MIDI Control** (MPC Key 61, MPC Key 37).
- Press and hold **Mode** and press **Pad 11** (MPC Studio).

### Important:

**In Standalone Mode:** Make sure your MPC hardware is using the correct MIDI output. You can set this using the **MIDI Output Port** field at the top of the touchscreen, or in **Preferences** (see [General Features > Menu > Preferences > MIDI / Sync](#)).

**In Controller Mode:** In your host software, make sure your MPC hardware is selected as a MIDI controller device.

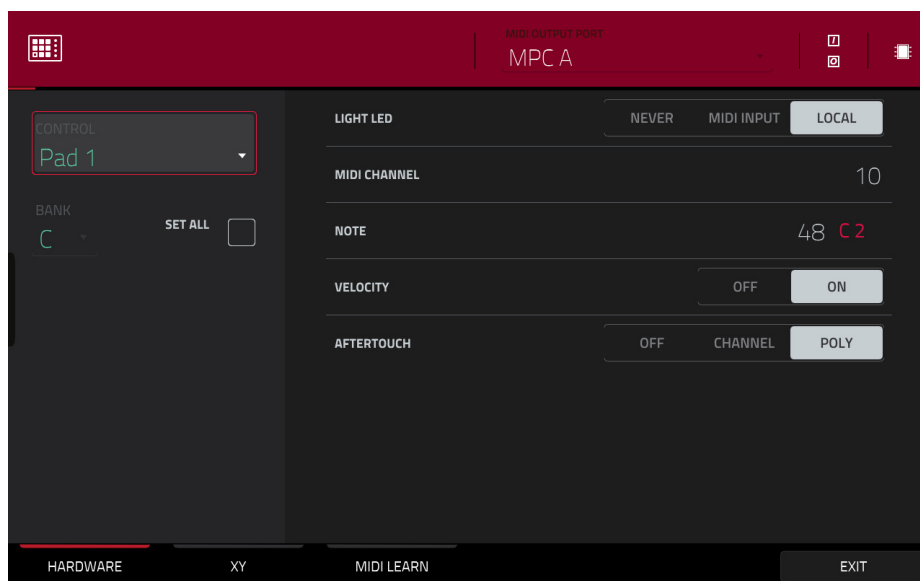

In the touchscreen, use the fields and selectors to set each control’s parameters to your preference. The available parameters depend on its type: a **pad**, or **button**, a **Q-Link knob**, or each axis of the **XY pad**. When you have set all of the parameters as desired, you can select another control or enter another mode.

Use the **MIDI Output Port** field at the top of the touchscreen to set the MIDI port that the MPC hardware will send messages from. You can also set this in the **MIDI / Sync** section of the [Preferences](#) menu.

Tap the I/O buttons at the top of the touchscreen to open the [MIDI Monitor](#).

To select a control to edit, do any of the following:

- Press or turn it. In the lower-left corner, tap the **Hardware** tab to edit a **pad**, **button**, or **Q-Link knob**, or tap the **XY** tab to edit the **XY pad**.
- Tap the **Control** field in the upper-left corner, and then turn the **data dial** to select one.
- Double-tap the **Control** field, and then tap a control name in the menu that appears.

**Note:** The **Control** field menu will show many more hardware controls than are actually available on your MPC hardware. This is because the list includes all possible controls from all current MPC models (MPC X, MPC Live, MPC Touch, etc.). You can edit only the controls that are described in this chapter.

**Note:** The software window will also display a graphical interface resembling your MPC hardware. Editable controls show their current MIDI message. Pads and Q-Link knobs show their current MIDI channels.

## Pads

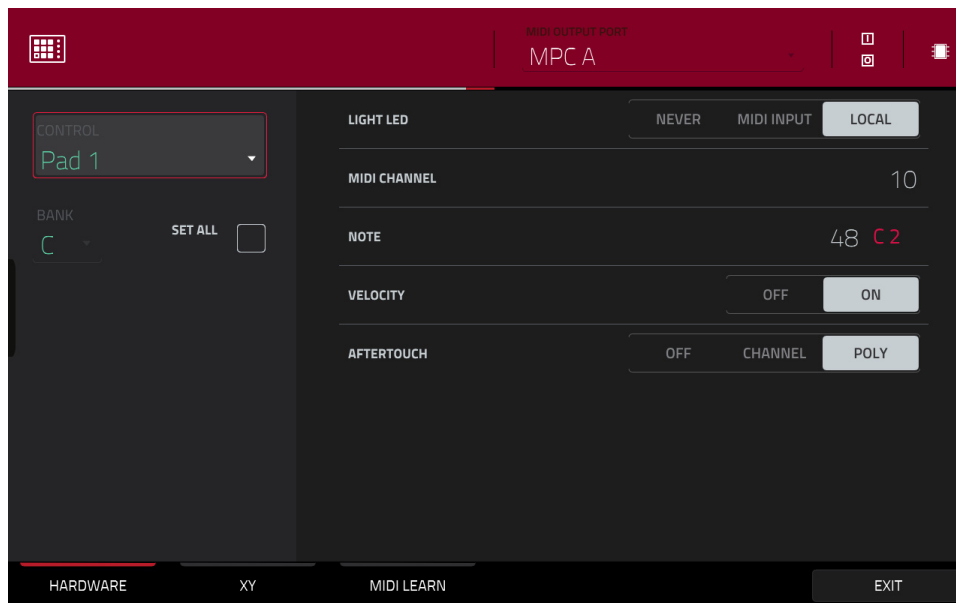

These are the MIDI parameters you can edit for each **pad**:

**Control:** This is the hardware control you are currently editing (**Pad 1–Pad 16**).

**Bank:** This is the pad bank the pad belongs to. If you check the **Set All** box, the pad's messages and parameters will be identical across all eight banks.

**Set All:** When this box is checked, the pad's messages and parameters will be identical across all eight banks. When this box is unchecked, the pad's messages and parameters will apply to the current pad only.

**Light LED:** This determines how the pad's LEDs will behave.

When set to **Never**, the LEDs will always be off.

When set to **MIDI Input**, the LEDs will light up when the software receives a MIDI message that matches the pad.

When set to **Local**, the LEDs will light up when you press the pad and/or MIDI input is received.

**MIDI Channel:** This determines which MIDI channel (**1–16**) the pad will use to send its message to the software.

**Note:** This is the MIDI note number the pad will send to the software when you press it (**0–127** or **C-2 to G8**).

**Velocity:** This determines whether the pad will be velocity-sensitive (**On**) or not (**Off**). When set to **Off**, pressing the pad will send a note at full-level (**127**) always.

**Aftertouch:** This determines how the pad's aftertouch (pressure applied to the pad after the initial press) behaves.

**Off:** The pad will not send any aftertouch messages.

**Channel:** If you press multiple pads that have this setting, the aftertouch messages they send will be identical.

**Poly:** If you press multiple pads, the aftertouch message each pad sends will be independent from the others.

## Buttons

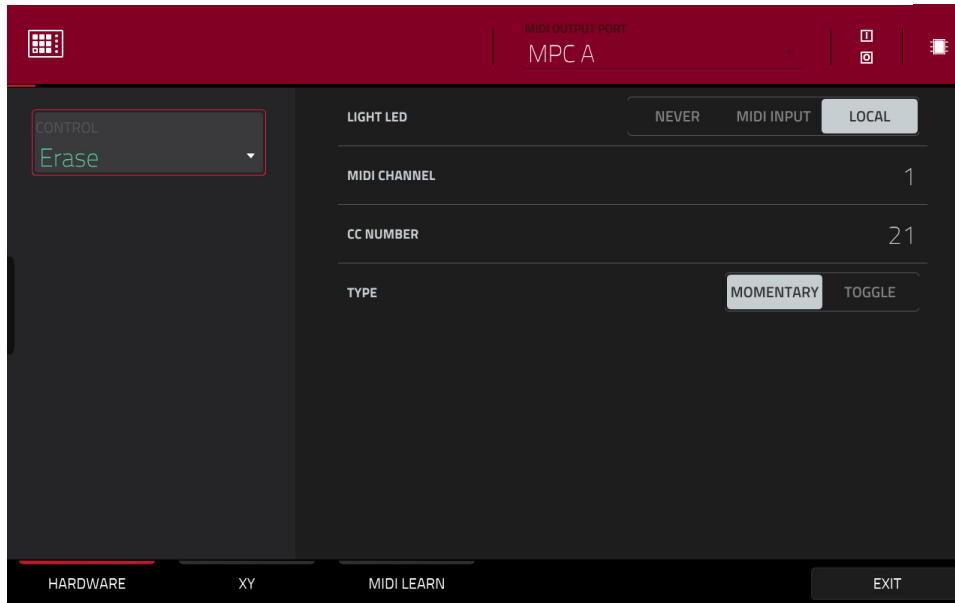

These are the MIDI parameters you can edit for each button. You can edit the **Erase**, **Tap**, **Undo/Redo**, or **Copy/Delete** buttons:

**Control:** This is the hardware control you are currently editing (**Erase**, **Tap**, **Undo**, or **Copy**).

**Light LED:** This determines how the button's LED (or multiple LEDs) will behave.

When set to **Never**, the LEDs will always be off.

When set to **MIDI Input**, the LEDs will light up when the software receives a MIDI message that matches the button.

When set to **Local**, the LEDs will light up when you press the button and/or MIDI input is received.

**MIDI Channel:** This determines which MIDI channel (**1–16**) the button will use to send its message to the software.

**CC Number:** This determines what MIDI Control Change number the button will send to the software.

**Type:** This determines whether the button will behave as a **Momentary** switch or **Toggle** (latching) switch.

## Q-Link Knobs

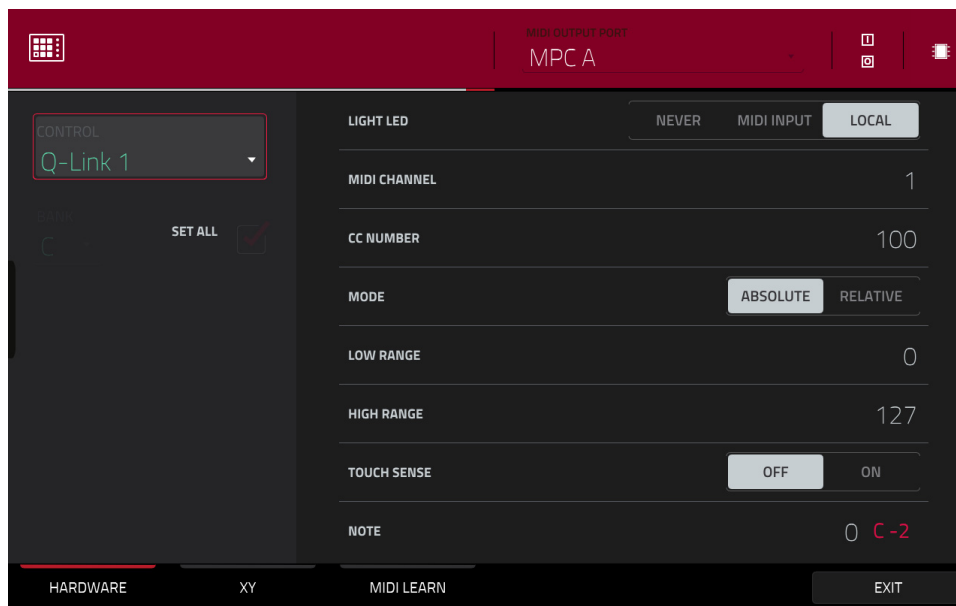

These are the MIDI parameters you can edit for each **Q-Link knob**:

**Control:** This is the hardware control you are currently editing (**Q-Link 1–4**).

**Light LED:** Although you can edit this parameter, it does not actually have a function on your MPC hardware.

When set to **Never**, the LEDs will always be off.

When set to **MIDI Input**, the LEDs will light up when the software receives a MIDI message that matches the Q-Link knob.

When set to **Local**, the LEDs will light up when you touch or turn the Q-Link knob and/or MIDI input is received.

**MIDI Channel:** This determines which MIDI channel (**1–16**) the Q-Link knob will use to send its message to the software.

**CC Number:** This determines what MIDI Control Change number the Q-Link knob will send to the software.

**Mode:** This determines how the Q-Link knob will control its parameter.

**Absolute:** The Q-Link knob's current position determines its parameter's value; moving it may cause its parameter to "snap" to a new position if you're using it to control different parameters in different modes.

**Relative:** Moving the Q-Link knob will increase or decrease its parameter regardless of its physical position.

**Low Range:** This is the Q-Link knob's lowest possible value (**0–127**).

**High Range:** This is the Q-Link knob's highest possible value (**0–127**).

**Touch Sense:** This activates or deactivates the Q-Link knob's touch-capacitive circuitry.

**On:** You can touch the Q-Link knob to send a Note On message to the software (this is how your MPC hardware normally works).

**Off:** The Q-Link knob will not send any Note On messages; it will only send CC messages when you turn it.

**Note:** This is the MIDI note number the Q-Link knob will send to the software when you touch it (**0–127** or **C-2** to **G8**). **Touch Sense** must be set to **On** for this to work.

## XY Pad

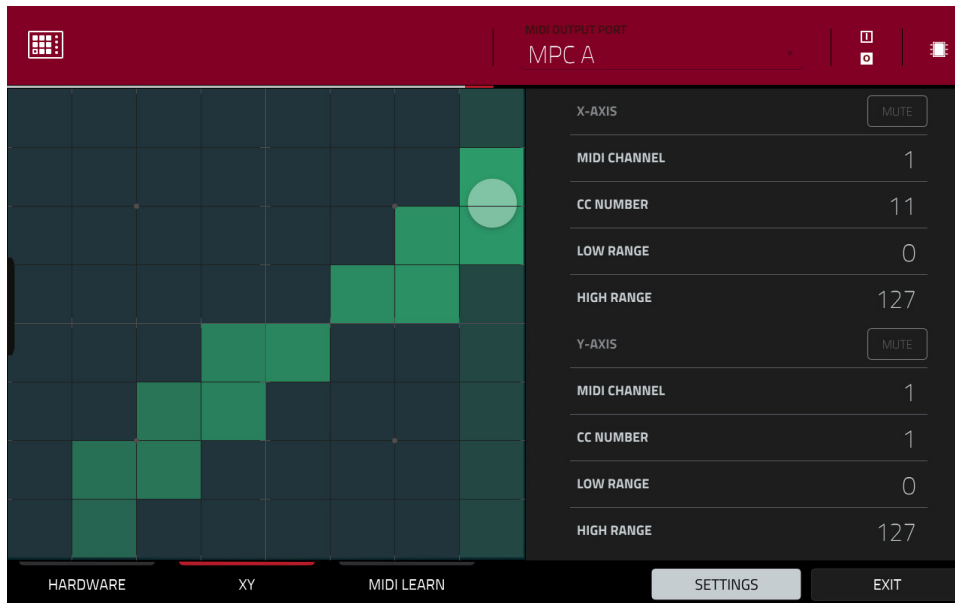

These are the MIDI parameters you can edit for each axis of the **XY pad**:

**Control:** This is the axis you are currently editing (**XYFX X-Axis** or **XYFX Y-Axis**). This field will be hidden if you tapped the **XY** tab to show the XY pad's parameters. You can tap the **Hardware** tab to show this field.

**Mute:** This button determines whether the axis is muted or not. When muted, its MIDI output is disabled. You must be viewing the **Settings** to do this.

**MIDI Channel:** This determines which MIDI channel (**1–16**) the axis will use to send its message to the software.

**CC Number:** This determines what MIDI Control Change number the axis will send to the software.

**Low Range:** This is the axis's lowest possible value (**0–127**).

**High Range:** This is the axis's highest possible value (**0–127**).



## MIDI Learn

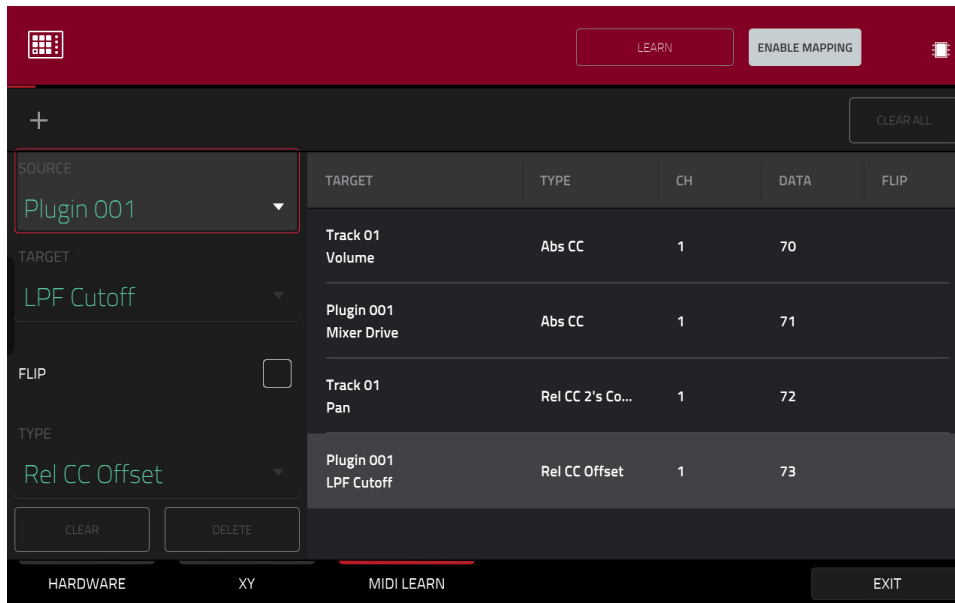

You can use the MIDI Learn function to assign external MIDI controllers to various parameters in your specific MPC project:

- Mixer parameters such as volume, pan, mute, and solo for MIDI or audio tracks, programs, returns, submixes, and main outputs
- Pad parameters (for drum programs and clip programs only) such as tuning, filter and amp envelopes, layer settings, LFO settings, and velocity
- Program parameters, which depend on the program type
- Insert effects parameters, which depend on the effect type

These assignments will be saved with your MPC project.

**Tip:** Because these MIDI assignments are saved within a project, you can use them while working with a project on both the desktop version of the MPC software **or** on your MPC hardware in Standalone Mode. You can also include them with a user template.

**To display the MIDI Learn window,** press **Menu**, tap **MIDI Control** to enter MIDI Control Mode, and then tap the **MIDI Learn** tab.

Each assignment has the following settings:

**Source:** This is the name or number of the track, program, return, submix, or main output.

**Target:** This is the name of the assigned command or parameter.

**Type:** This is the type of message:

- **Toggle Button:** When the control is a button, pressing it will activate or deactivate its command or parameter. It will remain in that state until you press it again.
- **Momentary Button:** When the control is a button, pressing and holding it down will activate its command or parameter. Releasing the button will deactivate it.
- **Fixed Button:** When the control is a button, pressing it will send its command.
- **Note:** When the control is a button, pressing it will send the MIDI note (determined by the **Data** field).
- **Abs CC:** When the control is a knob, turning it will send its CC message (determined by the **Data** field) according to the precise physical position of the knob. (When you start turning it, the value may “jump” from its current value to the one corresponding to the knob’s position.) This is for use with knobs that have a maximum and minimum position.

- **Rel CC Offset:** When the control is a knob, turning it will send the CC message (determined by the **Data** field), starting from the current value. This is for use with 360° knobs controlling parameters that have a maximum and minimum position.
- **Rel CC 2's Complement:** When the control is a knob, turning it will send the CC message (determined by the **Data** field), starting from the current value. This is for use with 360° knobs controlling bipolar parameters where there is a center (12:00) position (e.g., panning).

This is automatically detected based on the **Source** and **Target** fields, though you can use this field to assign it manually if it does not detect it properly.

**Ch:** This is the MIDI channel the control is using.

**Data:** This is the MIDI note number or CC number.

**Flip:** Tap this box to select or deselect it. When selected, the control's polarity will be reversed (e.g., a button's "off" state will become its "on" state and vice versa).

#### To assign a parameter to a hardware control:

1. Tap **Learn** in the upper-right corner so it is **on**. (The **Enable Mapping** button will also activate if it is not already on.)
2. Tap **+** in the upper-left corner to create an "empty" assignment (its **Target** menu will be set to **None** and **Off**).  
Alternatively, tap an assignment that is already in the list if you want to change it.
3. Move or press the desired control on your MIDI controller. The **Type**, **Ch**, and **Data** fields will be automatically assigned.
4. Use the **Source** field to select a MIDI or audio track, program, return, submix, or main output (for drum programs and clip programs, you can select the entire program or a single pad within it). The **Target** menu will indicate the source you selected.
5. Use the **Target** menu to select the parameter. Your selection will be shown under **Target** in the list, as well.  
The control on your MIDI controller will now control the **Target** parameter.

**To assign more controls**, repeat **Steps 2–5**.

**To stop assigning controls**, tap **Learn** again so it turns **off**.

**To clear an assignment**, follow the steps above to reassign its **Source** field to **None** and assign its **Target** field to **Off**.

**To clear a MIDI control from an assignment**, tap it in the list, and then tap **Clear** in the lower-left corner.

**To delete an assignment** (the entire slot), tap it in the list, and then tap **Delete** in the lower-left corner.

**To delete all assignments**, press and hold **Shift**, and then tap **Delete** in the lower-left corner. In the window that appears, tap **Remove All** to continue or tap **Cancel** to not delete any assignments.

## Keyboard Control

The keyboard control screen allows you to edit the functions of the keyboard on MPC Key 61 and MPC Key 37.

**To access Keyboard Control**, press the **Keyboard Control** button on your MPC Key 61 or MPC Key 37. You can then edit the following parameters.

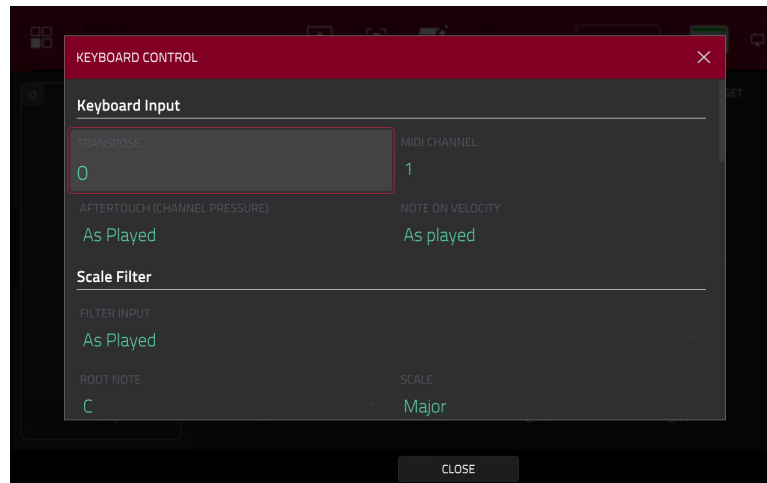

### Keyboard Input

**Transpose:** This determines the amount of transposition to the keyboard, up to **36 semitones** up or down.

**MIDI Channel:** This determines which MIDI channel (**1–16**) the keyboard input will use to receive messages.

**Aftertouch (Channel Pressure):** This determines whether aftertouch is enabled (**As Played**) or not (**Disable**).

**Note On Velocity:** This determines the incoming velocity of note on messages. For velocity that is responsive to your playing, select **As played**. Alternatively, you can set a fixed velocity for all note on messages, at **12%, 18%, 25%, 31%, 37%, 43%, Half, 56%, 62%, 68%, 75%, 81%, 87%, 93%** or **Full** velocity.

### Scale Filter

**Filter Input:** This determines how specific notes are filtered. Select **As Played** to apply no filtering, **Snap to Scale** to shift non-scale notes played to the nearest scale degree, or **Filter to Scale** to disable non-scale notes from playing entirely.

**Root Note:** This determines the root note of the set scale.

**Scale:** This determines the type of scale used for note filtering. The available scales are:

|                  |                  |          |                 |
|------------------|------------------|----------|-----------------|
| Chromatic        | Pentatonic Minor | Aeolian  | Hungarian Gypsy |
| Major            | Dorian           | Locrian  | Persian         |
| Natural Minor    | Phrygian         | Blues    | Major Bebop     |
| Harmonic Minor   | Lydian           | Flamenco | Whole Tone      |
| Pentatonic Major | Mixolydian       | Gypsy    |                 |

### Internal Keyboard Routing

**Keyboard Route:** This determines where MIDI data from the keyboard is sent. Select from the following options:

**Local Off:** Keyboard MIDI data is only sent to the MIDI out. This may be useful if working with external sound modules.

**Global:** Keyboard MIDI data will always go to the current track.

**Tracks:** The Keyboard will appear as a port in the list of available track MIDI Inputs.

**Global and Tracks:** Keyboard MIDI data will go to the current track and be available as a track MIDI input.

## External Keyboard Routing

**MIDI Output Port:** This determines the MIDI port where the keyboard will output MIDI externally.

**Keyboard sends MIDI here:** Check this box to send all MIDI from the keyboard to the selected MIDI Output port.

**MIDI Channel:** This determines which MIDI channel (**1–16**) the keyboard will use to send messages externally.

**Minimum Note / Maximum Note:** This determines the range of notes that will output MIDI externally.

## Keyboard Settings

**Velocity Response:** This determines how playing the keys translates into velocity values. Select preset **Light 1–3**, **Linear**, or **Heavy 1–3** responses, or select **Custom** to create your own response using the following settings:

**Velocity Curve:** Use this slider to adjust the velocity curve, from **-50** to **0** to **+50**. At negative values, it takes more force to hit higher velocity values; at positive values, it takes less force.

**Gain:** Use this slider to apply additional gain to the velocity curve, from **-20** to **0** to **+20**. Increasing the gain will make it easier to hit high velocity values, and decreasing it will make it harder.

**Black Key Sensitivity:** Use this slider to set the sensitivity of the keyboard's black keys, from **-20** to **0** to **+20**.

**White Key Sensitivity:** Use this slider to set the sensitivity of the keyboard's white keys, from **-20** to **0** to **+20**.

## Pedal Settings

**Pedal:** This determines the pedal input port from MPC Key 61/MPC Key 37. Select **Sustain**, **FS2**, or **Expression**.

**Type:** This determines the pedal type, either **Switch** (on/off) or **Variable** (such as an expression pedal).

**Polarity:** This determines the polarity of the pedal input. Select **Auto**, **Positive**, or **Negative**. If you are having issues with your pedal, check the settings on your hardware or try adjusting this field for the correct behavior.

**CC Assign:** This is the MIDI CC assignment the pedal will send. Select **Disable**, **Default** (varies depending on the port used), or **CC 000–126**.

## Pitch Bend / Mod Wheel

**Pitch Bend:** Use this field to select the MIDI function for the keyboard pitch wheel. Select **Disable**, **Default – Pitch Bend**, or **CC 000–126**.

**Mod Wheel:** Use this field to select the MIDI function for the keyboard modulation wheel. Select **Disable**, **Default – CC 001: Modulation**, or **CC 000–126**.

## Global Pitch Bend Settings

**Global Pitch Bend:** Check this box to override the pitch bend settings of all programs, so that those with pitch bend disabled or set to different ranges will only use the Global Range instead. When unchecked, all programs may use their individual pitch bend settings.

**Range Up/Range Down:** Use these sliders to set the range of the pitch bend in semitones.

## Ableton Control Mode

See [Addenda > Updates in MPC 2.7 > New Features > Ableton Live Control](#) for more information.

**Note:** Ableton Control Mode is not compatible with MPC One, MPC Touch, and MPC Studio.

## Pad Perform Mode



Pad Perform Mode lets you assign musical scales/modes, chords, or progressions to the pads for more creative performance.

**To open the Pad Perform window,** do any of the following while using a keygroup program, MIDI program, plugin program, or CV program:

- Tap **Pad Perform** in the Program section of Main Mode.
- Press **Pad Perform** (MPC X).
- Hold **Shift** and press **16 Level** (MPC Live, MPC Live II, MPC One, MPC Key 61, MPC Key 37, and MPC Touch).

Although you can enter Pad Perform Mode while using a drum program or clip program, it does not work with these programs.

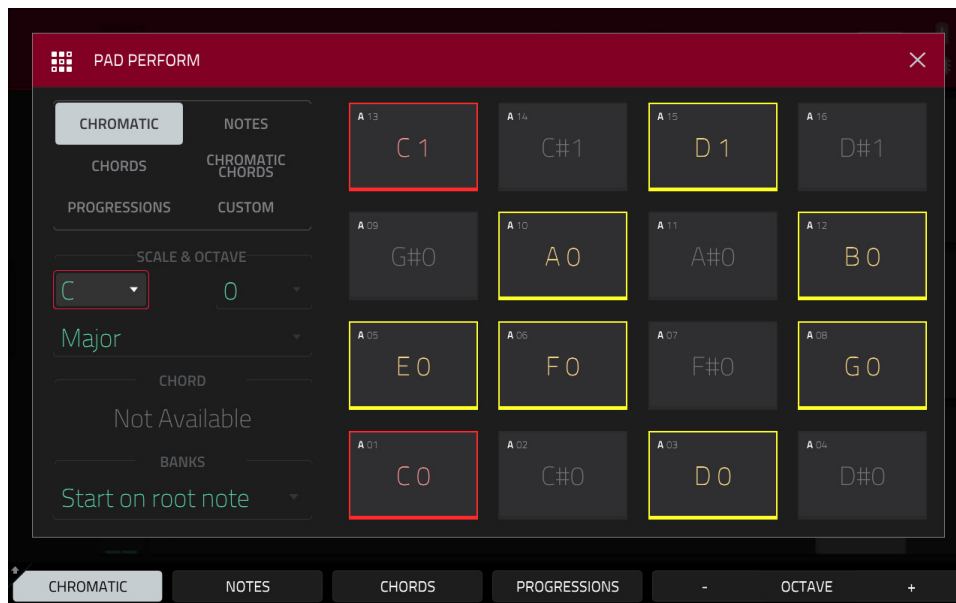

The touchscreen will show the current pad bank's mapping of notes or chords.

Use the type selector in the top-left to determine what will be mapped over the pads:

**Chromatic:** Each pad is assigned a note, ascending by one semitone with each pad. Pads with notes in the key determined by the **Scale** will be lit, while pads with notes between the scale degrees will be unlit.

**Notes:** Each pad is assigned a note, ascending by one scale degree with each pad.

**Chords:** Each pad is assigned a chord, the root note ascending by one scale degree with each pad. All available chords will play in the key determined by the **Scale**.

**Chromatic Chords:** Each pad is assigned a chord, the root note ascending by one scale degree with each pad. You can play any chord type regardless of the key determined by the **Scale**. Essentially, this is like the Chords setting but with more options to play chords out of the set key.

**Progressions:** Each pad is assigned a chord in a chord progression. You can play the pads in (or out of) order to construct songs quickly. The available chords are determined by the **Chord** field.

**Tip:** You can use your own progressions (created in the desktop version of the MPC software) on your MPC hardware. See [Addenda > Updates in MPC 2.1 > New Features > Pad Perform Mode: User Progressions](#) to learn more about this.

**Custom:** Each pad is assigned a custom note. See [Addenda > Updates in MPC 2.11 > New Features > Pad Perform and 16 Levels Enhancements](#) to learn more about this.

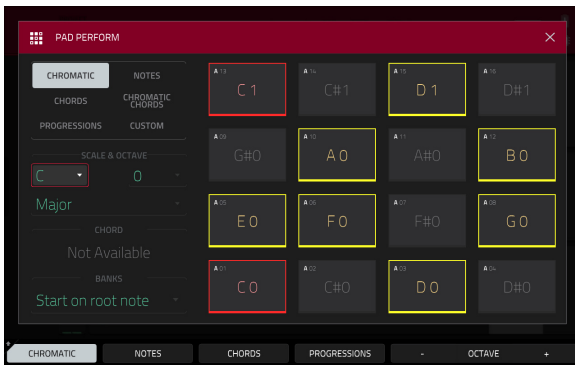

Chromatic Notes in Pad Perform Mode.

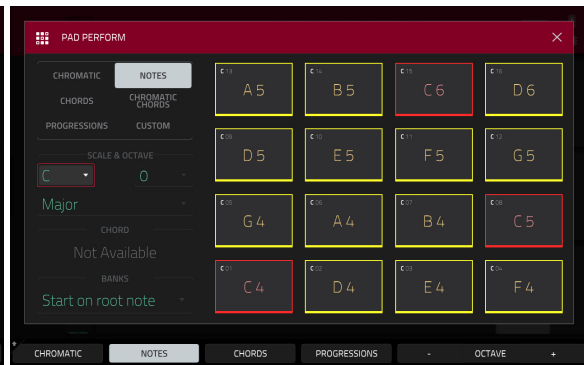

Notes in Pad Perform Mode.

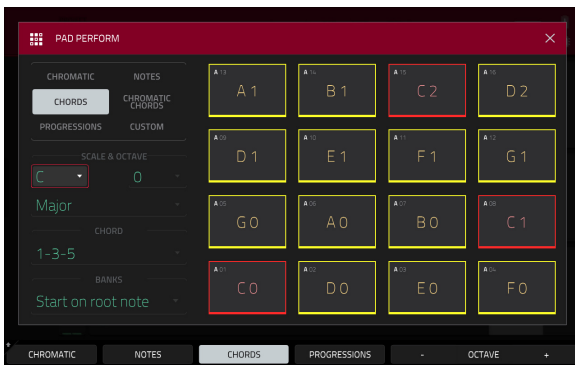

Chords in Pad Perform Mode.

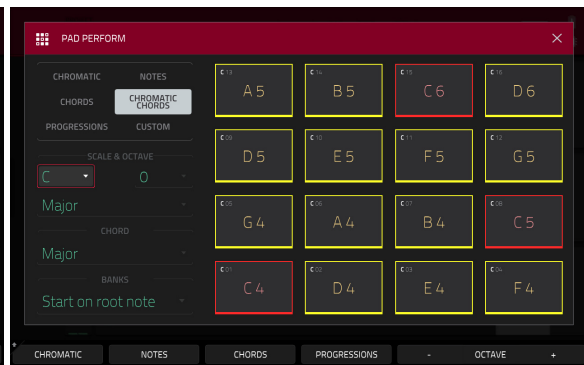

Chromatic Chords in Pad Perform Mode.

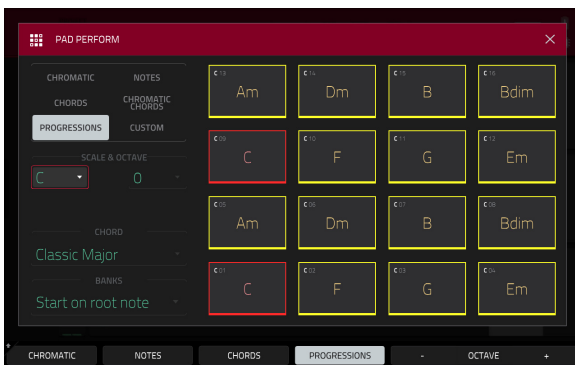

Progressions in Pad Perform Mode.

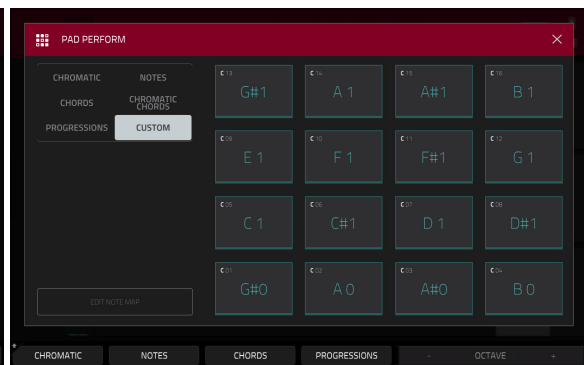

Custom Map in Pad Perform Mode

Use the **Scale & Octave** fields to determine the root note and the scale type.

**Root Note** (pitch and register): This is the starting point of the scale. The available notes are all chromatic notes across the range of the pads. The pad that's assigned the root note will be lit differently (and highlighted on the screen) to indicate where the scale starts in each octave.

**Scale Type**: This is the scale or mode based on the root note (this is disabled when **Type** is set to **Progressions**). The available scales are:

|                  |                 |             |            |
|------------------|-----------------|-------------|------------|
| Major            | Blues (minor)   | Major Bebop | Lydian     |
| Natural Minor    | Flamenco        | Whole Tone  | Mixolydian |
| Harmonic Minor   | Gypsy           | Chromatic   | Aeolian    |
| Pentatonic Major | Hungarian Gypsy | Dorian      | Locrian    |
| Pentatonic Minor | Persian         | Phrygian    |            |

Use the **Chord** fields to determine what chord type will play when pressing a pad. The chord will use those scale degrees based off of the pad's root note. You can use this only when the **Type** is set to **Chords** or **Chromatic Chords**.

When set to **Chords**, the available chords are:

|                     |                         |
|---------------------|-------------------------|
| 1-3-5 (major/minor) | 1-3-5-7 (major7/minor7) |
| 1-4-5 (sus4)        | 1-3-5-7b (dominant)     |
| 1-2-5 (sus2)        |                         |

When set to **Chromatic Chords**, the available chords are:

|       |        |            |
|-------|--------|------------|
| Major | Major7 | Augmented  |
| Minor | Minor7 | Diminished |
| Sus2  | Major9 |            |
| Sus4  | Minor9 |            |

Use the **Banks** field to determine how the notes are mapped across the pad banks.

**Continuous: Pad 01** of one bank is always one scale degree higher than **Pad 16** of the previous bank.

**Start on Root: Pad 01** will always be the root note of the scale in every pad bank.

You can use the buttons at the bottom of the screen to quickly select different Types and Chords:

Tap **Notes** to automatically set the **Type** to **Notes**.

Tap **Chords** to automatically set the **Type** to **Chords**.

Tap **Progressions** to automatically set the **Type** to **Progressions**.

Tap **Octave -/+** to shift the pad assignments down or up by an octave.

Press **Shift+1-3-5** to automatically set the **Type** to **Chords** and set the **Chord** to **1-3-5** (major/minor).

Press **Shift+1-4-5** to automatically set the **Type** to **Chords** and set the **Chord** to **1-4-5** (sus4).

Press **Shift+1-3-5-7** to automatically set the **Type** to **Chords** and set the **Chord** to **1-3-5-7** (major7/minor7).

Press **Shift+1-3-5-7b** to automatically set the **Type** to **Chords** and set the **Chord** to **1-3-5-7b** (dominant).

Press **Shift+Note -/+** to shift the pad assignments down or up by a semitone, essentially raising or lowering the **Root Note** field by a half-step.

## Appendix

### Effects & Parameters

This chapter lists the available effects. To learn more about how effects work with MPC, please see [General Features > Effects](#).

Effects with a \* next to their name are not included with MPC and are available for purchase from [thempcstore.com](http://thempcstore.com).

**Note:** Some of these effects have a “sync” version (e.g., **Flanger Sync**, **Autopan Sync**, etc.) whose rates will be affected by the current tempo. While viewing the rate of these effects, a “.” next to the time division indicates a triplet-based rate.

### Delay/Reverb

**Options:** [AIR Delay](#), [AIR Diff Delay](#), [AIR Multitap Delay\\*](#), [AIR Non-Lin Reverb](#), [AIR Reverb](#), [AIR Spring Reverb](#), [Delay Analog Sync](#), [Delay Analog](#), [Delay HP](#), [Delay LP](#), [Delay Mono Sync](#), [Delay Mono](#), [Delay Multi-Tap](#), [Delay Ping Pong](#), [Delay Stereo](#), [Delay Sync \(Stereo\)](#), [Delay Tape Sync](#), [Reverb In Gate](#), [Reverb Large 2](#), [Reverb Large](#), [Reverb Medium](#), [Reverb Out Gate](#), [Reverb Small](#), [Sample Delay](#)

#### AIR Delay

This is a classic delay line effect with a variable feedback filter. Additional Ratio and Width parameters enable you to achieve a wide range of stereo delay effects.

| Parameter       | Value Range       | Default Value |
|-----------------|-------------------|---------------|
| Time            |                   |               |
| Sync Off        | 1 ms – 2.00 s     | 388 ms        |
| Sync On         | 1/32 – 8/4        | 1/8D          |
| Sync            | Off, On           | Off           |
| Feedback        | 0–100%            | 40%           |
| Mix             | 0–100% (dry–wet)  | 50%           |
| Delay Ratio     | 50:100 – 100:50   | 100:100       |
| Delay HPF       | 20.0 Hz – 1.0 kHz | 20.0 Hz       |
| Delay Width     | 0–100%            | 100%          |
| Feedback Damp   | 1.0 – 20.0 kHz    | 20.0 kHz      |
| Feedback Reso   | 0–100%            | 0%            |
| Fdbk. Reso Freq | 100 Hz – 10.0 kHz | 1.0 kHz       |



### AIR Diff Delay

This is a delay line effect that is synchronized to your session tempo and uses an adjustable amount of diffusion to emulate the dissipation of echoes in reverberant space.

| Parameter       | Value Range  | Default Value   |
|-----------------|--|-----------------|
| Time            | Sync Off: 1 – 1000 ms<br>Sync On: 1/64 – 4/4 (including Triplet and Dotted variations) | 161 ms<br>1/16D |
| Sync            | Off, On  | On              |
| Width           | 0–100%   | 100%            |
| Mix             | 0–100% (dry–wet)   | 40%             |
| Feedback        | 0–100%   | 50%             |
| Fdbk. Diffusion | 0–100%   | 40%             |
| Fdbk. High Damp | 0–100%   | 35%             |
| Low Cut         | 20.0 Hz – 1.00 kHz   | 20.0 Hz         |
| Pan             | -100 – 0 – +100%   | 0%              |

### AIR Multitap Delay \*

This effect is a versatile, creative delay plugin with a wide range of applications from subtle stereo delays to complex repeating patterns.

| Parameter | Value Range                                    | Default Value |
|-----------|--|---------------|
| Delay     | Sync On: 1/16 – 8/4<br>Sync Off: 0 ms – 4.00 s | 4/4<br>2.25 s |
| Feedback  | 0–100%   | 50%           |
| Mix       | -100.0 – 0.0 dB                                | -50.0 dB      |
| From/To   | Varies   | Tap 5 / Input |
| Sync      | Off, On  | On            |
| Low Cut   | 20.0 Hz – 1.00 kHz                             | 500 Hz        |
| High Cut  | 1.00 kHz – 20.0 kHz                            | 2.00 kHz      |
| 1–5       | Off, On  | On            |
| Tap Delay | 10.0 ms – 10.0 s                               | Varies        |
| Pan       | L100 – C – R100                                | Varies        |
| Level     | -Inf – 0.0 dB                                  | 0.0 dB        |

### AIR Non-Lin Reverb

This is a spatial effect, designed to produce synthetic, processed ambience with special gated and reversed reverb effects.

| Parameter | Value Range      | Default Value |
|-----------|------------------|---------------|
| Pre-Delay | 0–250 ms         | 0 ms          |
| Dry Delay | 0–1500 ms        | 0 ms          |
| Time      | 0–1000 ms        | 250 ms        |
| Mix       | 0–100% (dry–wet) | 50%           |
| Diffusion | 0–100%           | 100%          |
| Width     | 0–100%           | 50%           |
| Shape     | Gated, Reverse   | Gated         |
| Low-Cut   | 20.0 Hz–1.00 kHz | 141 Hz        |
| High-Cut  | 1.00–20.0 kHz    | 9.46 kHz      |

### AIR Reverb

This is a spatial effect, with a wide range of reverb types to add space or room to your audio signal.

| Tab               | Parameter     | Values   | Default Value |
|-------------------|---------------|--|---------------|
| <b>Reverb</b>     | Pre-Delay     | 0–250 ms   | 0 ms          |
|                   | Room Size     | 0–100%   | 100%          |
|                   | Time          | 0.4 ms – +inf s  | 1.9 s         |
|                   | Mix           | 0–100%   | 50%           |
| Early Reflection  | Type          | Off, Booth, Club, Room, Small Chamber, Medium Chamber, Large Chamber, Small Studio, Large Studio, Scoring Stage, Philharmonic, Concert Hall, Church, Opera House, Vintage 1, Vintage 2 | Off           |
|                   | Length        | 0–100%   | 100%          |
|                   | ER / Tail Mix | 0–100%   | 50%           |
| Reverb            | Input Width   | 0–100%   | 0%            |
|                   | Output Width  | 0–100%   | 0%            |
|                   | Delay         | 0–250 ms   | 0 ms          |
| Room              | Ambience      | 0–100%   | 0%            |
|                   | Density       | 0–100%   | 100%          |
| <b>Hi/Lo Freq</b> |               |  |               |
| Hi Freq           | Time          | -100 – 0 – 100%  | 0%            |
|                   | Freq          | 2.00 – 20.0 kHz  | 6.32 kHz      |
|                   | Cut           | 1.0 – 20.0 kHz   | 9.46 kHz      |
| Lo Freq           | Time          | -100 – 0 – 100%  | 0%            |
|                   | Freq          | 20.0 Hz – 2.00 kHz   | 200 Hz        |
|                   | Cut           | 1 – 1000 Hz  | 1 Hz          |

### AIR Spring Reverb

This is a spatial effect, designed to emulate the sound of a spring reverb tank.

| Parameter | Value Range      | Default Value |
|-----------|------------------|---------------|
| Pre-Delay | 0–250 ms         | 3 ms          |
| Time      | 1.0–10.0 s       | 4.0 s         |
| Mix       | 0–100 (dry–wet)  | 50%           |
| Diffusion | 0–100%           | 100%          |
| Width     | 0–100%           | 0%            |
| Low Cut   | 20.0 Hz –1.0 kHz | 141 Hz        |

### Delay Analog Sync

Analog Delay is similar to Mono Delay, except that it's designed to emulate an analog "Bucket Brigade"-style delay. This delay has a unique character to it that gives a warmer sound by adding subtle inaccuracies in phase and timing.

| Parameter | Value Range           | Default Value |
|-----------|-----------------------|---------------|
| Dry/Wet   | 0–100 (dry–wet)       | 50            |
| Time      | 1 bar – 1/16 triplets | 1/4           |
| Feedback  | 0–100                 | 50            |
| Ramp      | 0–100                 | 50            |

### Delay Analog

Analog Delay is similar to the Mono Delay, except that it's designed to emulate an analog "Bucket Brigade"-style delay. This delay has a unique character to it that gives a warmer sound by adding subtle inaccuracies in phase and timing.

| Parameter | Value Range     | Default Value |
|-----------|-----------------|---------------|
| Dry/Wet   | 0–100 (dry–wet) | 50            |
| Time      | 2–2000 ms       | 100           |
| Feedback  | 0–100           | 25            |

### Delay HP

HP Delay is identical to the Mono Delay, but it uses a resonant high-pass filter in the delay line.

| Parameter | Value Range     | Default Value |
|-----------|-----------------|---------------|
| Dry/Wet   | 0–100 (dry–wet) | 50            |
| Time      | 2–2000 ms       | 100           |
| Feedback  | 0–100           | 50            |
| Cutoff    | 0–100           | 33            |
| Resonance | 0–100           | 33            |

### Delay LP

LP Delay is identical to the Mono Delay, but it uses a resonant low-pass filter in the delay line.

| Parameter | Value Range     | Default Value |
|-----------|-----------------|---------------|
| Dry/Wet   | 0–100 (dry–wet) | 50            |
| Time      | 2–2000 ms       | 500           |
| Feedback  | 0–100           | 50            |
| Cutoff    | 0–100           | 50            |
| Resonance | 0–100           | 20            |

### Delay Mono Sync

This mono effect delays the original signal for a specified period of time (synced to the project tempo) and plays it back over an adjustable period of time.

| Parameter | Value Range           | Default Value |
|-----------|-----------------------|---------------|
| Dry/Wet   | 0–100 (dry–wet)       | 50            |
| Time      | 1 bar – 1/16 triplets | 1/4           |
| Feedback  | 0–100                 | 50            |
| Damping   | 0–100                 | 100           |

### Delay Mono

This mono effect delays the original signal for a specified period of time and plays it back over an adjustable period of time.

| Parameter | Value Range     | Default Value |
|-----------|-----------------|---------------|
| Dry/Wet   | 0–100 (dry–wet) | 50            |
| Time      | 2–2000 ms       | 100           |
| Feedback  | 0–100           | 25            |
| Damping   | 0–100           | 100           |

### Delay Multi-Tap

This delay is a mono delay which has three delay generators with independently adjustable delay times and stereo position.

| Parameter | Value Range     | Default Value |
|-----------|-----------------|---------------|
| Dry/Wet   | 0–100 (dry–wet) | 50            |
| Time 1    | 2–2000 ms       | 100           |
| Time 2    | 2–2000 ms       | 100           |
| Time 3    | 2–2000 ms       | 100           |
| Feedback  | 0–100           | 25            |
| Pan 1     | 0–100           | 50            |
| Pan 2     | 0–100           | 50            |
| Pan 3     | 0–100           | 50            |
| Damping   | 0–100           | 100           |
| Gain 1    | 0–100           | 25            |
| Gain 2    | 0–100           | 25            |
| Gain 3    | 0–100           | 25            |

### Delay Ping Pong

This stereo delay allows you to set different delay times for its left and right repeats.

| Parameter   | Value Range     | Default Value |
|-------------|-----------------|---------------|
| Dry/Wet     | 0–100 (dry–wet) | 50            |
| Time, Left  | 2–2000 ms       | 100           |
| Time, Right | 2–2000 ms       | 100           |
| Feedback    | 0–100           | 25            |
| Damping     | 0–100           | 100           |

### Delay Stereo

Stereo Delay operates similarly to Mono Delay but in true stereo.

| Parameter | Value Range     | Default Value |
|-----------|-----------------|---------------|
| Dry/Wet   | 0–100 (dry–wet) | 50            |
| Time      | 2–2000 ms       | 100           |
| Feedback  | 0–100           | 25            |
| Damping   | 0–100           | 100           |

### Delay Sync (Stereo)

This effect is the same as Delay Stereo but is synced to the project tempo.

| Parameter | Value Range           | Default Value |
|-----------|-----------------------|---------------|
| Dry/Wet   | 0–100 (dry–wet)       | 50            |
| Time      | 1 bar – 1/16 triplets | 1/4           |
| Feedback  | 0–100                 | 50            |
| Damping   | 0–100                 | 100           |

### Delay Tape Sync

Tape Delay emulates a delay system using an analog tape loop and a series of tape heads to produce an echo effect. This delay type yields a very distinct echo sound often heard in reggae and dub-style music.

| Parameter     | Value Range           | Default Value |
|---------------|-----------------------|---------------|
| Dry/Wet       | 0–100 (dry–wet)       | 50            |
| Time          | 1 bar – 1/16 triplets | 1/4           |
| Feedback      | 0–100                 | 50            |
| Ramp          | 0–100                 | 50            |
| Head 1        | 0–100                 | 100           |
| Head 2        | 0–100                 | 0             |
| Head 3        | 0–100                 | 0             |
| Head 4        | 0–100                 | 0             |
| Tone          | 0–100                 | 50            |
| Spread        | 0–100                 | 50            |
| Wow & Flutter | 0–100                 | 50            |

### Reverb In Gate

This is a hall reverb with an additional control. The reverb effect is cut off when the input drops below the level set in the **Gate In** parameter.

| Parameter        | Value Range     | Default Value |
|------------------|-----------------|---------------|
| Dry/Wet          | 0–100 (dry–wet) | 50            |
| Pre-Delay        | 1–100           | 50            |
| Early Reflection | 0–100           | 50            |
| Density          | 0–100           | 50            |
| Diffuse          | 0–100           | 50            |
| Decay            | 0–100           | 75            |
| Lo-Cut           | 0–100           | 10            |
| Hi-Cut           | 0–100           | 10            |
| Gate In          | 0–100           | 0             |

**Reverb Large 2**

This is a less CPU-intensive spatial effect, emulating the sound of a large hall.

| Parameter        | Value Range     | Default Value |
|------------------|-----------------|---------------|
| Dry/Wet          | 0–100 (dry–wet) | 50            |
| Pre-Delay        | 1–100           | 50            |
| Early Reflection | 0–100           | 50            |
| Density          | 0–100           | 50            |
| Diffuse          | 0–100           | 50            |
| Decay            | 0–100           | 75            |
| Lo-Cut           | 0–100           | 10            |
| Hi-Cut           | 0–100           | 10            |

**Reverb Large**

This is a spatial effect, designed to emulate the sound of a large hall.

| Parameter        | Value Range     | Default Value |
|------------------|-----------------|---------------|
| Dry/Wet          | 0–100 (dry–wet) | 50            |
| Pre-Delay        | 1–100           | 50            |
| Early Reflection | 0–100           | 50            |
| Density          | 0–100           | 50            |
| Diffuse          | 0–100           | 50            |
| Decay            | 0–100           | 75            |
| Lo-Cut           | 0–100           | 10            |
| Hi-Cut           | 0–100           | 10            |

**Reverb Medium**

This is a spatial effect, designed to emulate a medium room.

| Parameter        | Value Range     | Default Value |
|------------------|-----------------|---------------|
| Dry/Wet          | 0–100 (dry–wet) | 50            |
| Pre-Delay        | 1–100           | 50            |
| Early Reflection | 0–100           | 50            |
| Density          | 0–100           | 50            |
| Diffuse          | 0–100           | 50            |
| Decay            | 0–100           | 50            |
| Lo-Cut           | 0–100           | 15            |
| Hi-Cut           | 0–100           | 10            |

### Reverb Out Gate

This is a hall reverb that has an additional control. The reverb effect is cut off when the output drops below the level set in the **Gate Out** parameter.

| Parameter        | Value Range     | Default Value |
|------------------|-----------------|---------------|
| Dry/Wet          | 0–100 (dry–wet) | 50            |
| Pre-Delay        | 1–100           | 50            |
| Early Reflection | 0–100           | 50            |
| Density          | 0–100           | 50            |
| Diffuse          | 0–100           | 50            |
| Decay            | 0–100           | 75            |
| Lo-Cut           | 0–100           | 10            |
| Hi-Cut           | 0–100           | 10            |
| Gate Out         | 0–100           | 0             |

### Reverb Small

This is a spatial effect, designed to emulate a small room.

| Parameter        | Value Range     | Default Value |
|------------------|-----------------|---------------|
| Dry/Wet          | 0–100 (dry–wet) | 50            |
| Pre-Delay        | 1–100           | 50            |
| Early Reflection | 0–100           | 50            |
| Density          | 0–100           | 50            |
| Diffuse          | 0–100           | 50            |
| Decay            | 0–100           | 50            |
| Lo-Cut           | 0–100           | 15            |
| Hi-Cut           | 0–100           | 10            |

### Sample Delay

This effect is a utility delay plugin that can delay the left and right channels by different, small amounts to loosen percussion elements or add stereo width.

| Parameter    | Value Range                           | Default Value             |
|--------------|---------------------------------------|---------------------------|
| Left / Right | 0–11025 Samples<br>or<br>0.0–250.0 ms | 0 Samples<br>or<br>0.0 ms |
| Samples / MS | Samples, MS                           | Samples                   |
| Link         | Off, On                               | Off                       |

## Dynamics

Options: *AIR Channel Strip*, *AIR Compressor*, *AIR Expander\**, *AIR Limiter*, *AIR Maximizer*, *AIR Noise Gate*, *AIR Pumper*, *AIR Transient*, *Bus Compressor*, *Compressor Opto*, *Compressor VCA*, *Compressor Vintage*, *Mother Ducker Input*, *Mother Ducker*, *Transient Shaper*

### AIR Channel Strip

This specially-designed plugin combines multiple effects with a fast interface. The EQ section provides a highpass filter, low and high shelves, and a fully parametric mid-band. For dynamics, the AIR Compressor and Gate algorithms are perfect for achieving hard-hitting drum sounds.

| Tab       | Parameter       | Value Range        | Default Value |
|-----------|-----------------|--------------------|---------------|
|           | EQ Enable       | Enabled, Bypass    | Enabled       |
|           | Gate Enable     | Enabled, Bypass    | Enabled       |
|           | Comp Enable     | Enabled, Bypass    | Enabled       |
|           | Output          | -Inf – +24.00 dB   | 0.00 dB       |
| EQ        | High Shelf Gain | -12.0 – +12.0 dB   | 0.0 dB        |
|           | High Shelf Freq | 1.20 – 20.0 kHz    | 6.00 kHz      |
|           | Mid Gain        | -18.0 – +18.0 dB   | 0.0 dB        |
|           | Mid Freq        | 40.0 Hz – 16.0 kHz | 247 Hz        |
|           | Mid Q           | 0.40 – 10.00       | 1.00          |
|           | Low Shelf Gain  | -12.0 – +12.0 dB   | 0.0 dB        |
|           | Low Shelf Freq  | 20.0 Hz – 1.00 kHz | 100 Hz        |
|           | HP Filter       | 0 – 1000 Hz        | 0 Hz          |
| Gate/Comp | Gate Thresh     | -120.0 – 0.0 dB    | -120.0 dB     |
|           | Gate Depth      | 0 – -120.0 dB      | -120.0 dB     |
|           | Gate Attack     | 0.01 – 1000.00 ms  | 0.18 ms       |
|           | Gate Release    | 1.00 – 3000.00 ms  | 7.40 ms       |
|           | Comp Thresh     | 0.0 – -60.0 dB     | 0.0 dB        |
|           | Comp Ratio      | 1.0:1 – 100.0:1    | 3.9:1         |
|           | Comp Attack     | 100 us – 300 ms    | 5.48 ms       |
|           | Comp Release    | 10.0 ms – 4.00 s   | 200 ms        |



## AIR Compressor

This basic compressor effect changes the dynamic range of a signal by automatically reducing its gain if it exceeds a certain level (the threshold).

| Parameter | Value Range      | Default Value |
|-----------|------------------|---------------|
| Threshold | -60.0 – 0 dB     | -48.0 dB      |
| Ratio     | 1.0:1 – 100.0:1  | 3.9:1         |
| Output    | 0.0 – 30.0 dB    | 15.0 dB       |
| Mix       | 0–100% (dry-wet) | 100%          |
| Knee      | 0–100%           | 50%           |
| Attack    | 100 us – 300 ms  | 5.48 ms       |
| Release   | 10.0 ms – 4.00 s | 200 ms        |

## AIR Expander \*

This effect is a vital dynamic processor to reduce and remove the unwanted quieter elements of your tracks.

| Parameter | Value Range            | Default Value |
|-----------|------------------------|---------------|
| Threshold | -40.0 – 0.0 dB         | -15.4 dB      |
| Output    | -20.0 – 0.0 – +20.0 dB | 0.0 dB        |
| Ratio     | 1:1.0 – 1:100          | 1:10          |
| Range     | 0.0 – 40.0 dB          | 40.0 dB       |
| Attack    | 10.0 us – 100 ms       | 1.00 ms       |
| Release   | 10.0 ms – 10.0 s       | 166 ms        |

## AIR Limiter

This is a lookahead limiter perfect for mastering or mixing.

| Parameter  | Value Range        | Default Value |
|------------|--------------------|---------------|
| Gain       | -12.0 – 36.0 dB    | 0.0 dB        |
| Ceiling    | -24.0 – 0.0 dB     | 0.0 dB        |
| Look Ahead | 0.0 – 20.0 ms      | 0.0 ms        |
| Release    | 10.0 ms – 10.0 s   | 316 ms        |
| LF Mono    | 10.0 Hz – 1.00 kHz | 10.0 Hz       |

## AIR Maximizer

This effect is a limiter optimized for professional mastering.

| Parameter  | Value Range        | Default Value |
|------------|--------------------|---------------|
| Threshold  | -40.0 – 0.0 dB     | -20.0 dB      |
| Ceiling    | -20.0 – 0.0 dB FS  | -5.0 dB FS    |
| Look Ahead | 0.0 – 20.0 ms      | 0.0 ms        |
| Knee       | Hard, Soft         | Hard          |
| Release    | 10.0 ms – 10.0 s   | 316 ms        |
| LF Mono    | 10.0 Hz – 1.00 kHz | 10.0 Hz       |

### AIR Noise Gate

This effect is similar to a compressor, but instead of attenuating audio signal that rises above a threshold, a noise gate attenuates audio signal that falls below a threshold by a set amount. This can help reduce background noise in your audio signal.

| Parameter      | Value Range       | Default Value |
|----------------|-------------------|---------------|
| Threshold      | -120.0 – 0.0 dB   | -48.0 dB      |
| Depth          | 0 dB – -120.0 dB  | -120 dB       |
| Denoise Filter | Off, On           | Off           |
| Denoise Thresh | -120.0 – 0.0 dB   | -60.0 dB      |
| Attack         | 0.01 – 1000.00 ms | 0.18 ms       |
| Hold           | 0 – 1000 ms       | 250 ms        |
| Release        | 1.00 – 3000.00 ms | 7.40 ms       |

### AIR Pumper

This effect creates a rhythmic pumping effect, similar to that of sidechain compression.

| Parameter      | Value Range        | Default Value |
|----------------|--------------------|---------------|
| Depth          | 0–100%             | 80%           |
| Speed          | Bar, 1/2 – 1/32T   | 1/4           |
| Release Shape  | 0–100%             | 10%           |
| Trigger Offset | -100.0 – +100.0 ms | 0.0 ms        |
| Attack         | 0–100%             | 5%            |
| Hold           | 0–100%             | 10%           |
| Release        | 0–100%             | 60%           |

### AIR Transient

This effect is used to enhance or soften the Attack and Release phases of audio material.

| Parameter    | Value Range      | Default Value |
|--------------|------------------|---------------|
| Attack       | -100 – 0 – +100% | 0%            |
| Attack Shape | 0–100%           | 50%           |
| Sustain      | -100 – 0 – +100% | 0%            |
| Output       | -20.0 – +20.0 dB | 0.0 dB        |
| Limit        | Off, On          | On            |

### Bus Compressor

This is the most transparent compressor, able to perform substantial volume adjustments without artifacts.

| Parameter | Value Range     | Default Value |
|-----------|-----------------|---------------|
| Dry/Wet   | 0–100 (dry–wet) | 100           |
| Attack    | 0–100           | 50            |
| Release   | 0–100           | 50            |
| Threshold | -50 – 0 dB      | 0             |
| Ratio     | 1–20            | 1             |
| Oldskool  | Off, On         | Off           |
| Output    | -6 – 24 dB      | 0             |

### Compressor Opto

The Opto Compressor is modeled after a vintage compressor type using an optical circuit to control the volume reduction of the input signal. These compressors are usually associated with soft and unobtrusive attack and release characteristics.

| Parameter | Value Range     | Default Value |
|-----------|-----------------|---------------|
| Dry/Wet   | 0–100 (dry–wet) | 100           |
| Input     | -6 – 18 dB      | 0             |
| Attack    | 0–100           | 50            |
| Release   | 0–100           | 50            |
| Threshold | -50 – 0 dB      | 0             |
| Ratio     | 1–20            | 1             |
| Knee      | 1–100           | 1             |
| Output    | -6 – 24 dB      | 0             |

### Compressor VCA

This compressor is more modern-sounding, with a slightly more transparent sound. A VCA Compressor tends to have quicker attack and release times than an Opto Compressor.

| Parameter | Value Range     | Default Value |
|-----------|-----------------|---------------|
| Dry/Wet   | 0–100 (dry–wet) | 100           |
| Input     | -6 – 18 dB      | 0             |
| Attack    | 0–100           | 50            |
| Release   | 0–100           | 50            |
| Threshold | -50 – 0 dB      | 0             |
| Ratio     | 1–20            | 1             |
| Knee      | 1–100           | 1             |
| Output    | -6 – 24 dB      | 0             |

### Compressor Vintage

This compressor has a sound similar to classic tube compressors, with their gentle yet pumping response and a dash of tube saturation.

| Parameter | Value Range     | Default Value |
|-----------|-----------------|---------------|
| Dry/Wet   | 0–100 (dry–wet) | 100           |
| Input     | -6 – 18 dB      | 0             |
| Attack    | 0–100           | 50            |
| Release   | 0–100           | 50            |
| Threshold | -50 – 0 dB      | 0             |
| Ratio     | 1–20            | 1             |
| Knee      | 1–100           | 1             |
| Output    | -6 – 24 dB      | 0             |

## Mother Ducker Input

Add this effect as an insert to the track you want to use as a trigger input, such as a kick drum track.

| Parameter | Value Range | Default Value |
|-----------|-------------|---------------|
| To        | Bus 1–8     | Bus 1         |

## Mother Ducker

Add this effect as an insert to the track you want to have the ducking effect applied to. Use the meters to monitor the level from your trigger input and tweak the Threshold and Ratio parameters to adjust the amount of ducking. The Attack and Release parameters can be used to sculpt the envelope of the gain reduction to achieve exactly the pumping effect you are after. Mother Ducker has eight internal buses so you can set up multiple channel strips with ducking effects from different sources.

| Parameter | Value Range           | Default Value |
|-----------|-----------------------|---------------|
| Ratio     | 1.00:1 – 60.00:1      | 6.00:1        |
| Knee      | 0.000 – 6.000 dB      | 0.000 dB      |
| Attack    | 1.0 – 1000.0 ms       | 10.0 ms       |
| Release   | 1.0 – 1000.0 ms       | 100.0 ms      |
| Threshold | -100.000 – 0.000 dB   | -6.021 dB     |
| Gain      | -100.000 – +12.000 dB | -0.000 dB     |
| Auto Gain | On, Off               | On            |
| From      | Bus 1–8               | Bus 1         |

## Transient Shaper

A transient shaper can be used to enhance or soften the Attack and Release phases of audio material.

| Parameter | Value Range     | Default Value |
|-----------|-----------------|---------------|
| Dry/Wet   | 0–100 (dry–wet) | 100           |
| Attack    | 0–100           | 50            |
| Release   | 0–100           | 50            |
| Output    | 0–100           | 50            |

## EQ/Filter

Options: Options: [AIR Enhancer](#), [AIR Filter Gate](#), [AIR Filter](#), [AIR Kill EQ](#), [AIR Para EQ](#), [AIR Vintage Filter\\*](#), [HP Filter Sweep](#), [HP Filter Sync](#), [HP Filter](#), [HP Shelving Filter](#), [LP Filter Sweep](#), [LP Filter Sync](#), [LP Filter](#), [LP Shelving Filter](#), [PEQ 2-Band](#), [2-Shelf](#), [PEQ 4-Band](#)

## AIR Enhancer

This effect enhances the low and high broadband frequencies of the audio signal.

| Parameter  | Value Range                | Default Value |
|------------|----------------------------|---------------|
| High Gain  | 0.0 – 12.0 dB              | 0.0 dB        |
| Low Gain   | 0.0 – 12.0 dB              | 0.0 dB        |
| Output     | - Inf – 0.0 dB             | 0.0 dB        |
| Freq. High | 1.0 – 10.0 kHz             | 3.16 kHz      |
| Freq. Low  | 40.0 – 640 Hz              | 160 Hz        |
| Harmonics  | 0.0 – 12.0 dB              | 0.0 dB        |
| Phase      | + (positive), - (negative) | +             |

**AIR Filter Gate**

This effect chops your audio signal into rhythmic patterns with variable filtering, amplitude and panning.

| Parameter     | Value Range  | Default Value |
|---------------|--|---------------|
| Pattern       | Straight, Pulse, Pumper, Marching, Fader, Offbeats, Off+Pan, L/R Pan, LL/RR Pan, Slow Pan, Rand Pan, Shorter, Longer, Reverse, Random, Keyed 1–2, Half Time, 12-Step, Ducked, Trance 1–6, Tech 1–6 | Straight      |
| Rate          | 1/2–1/32, including Dotted and Triplet   | 1/16          |
| Swing         | 50.0–66.7%   | 50.0%         |
| Mix           | 0–100%   | 100%          |
| Filter Mode   | Off, LP, BP, HP, Phaser  | LP            |
| Filter Cutoff | -100 – 0 – 100%  | 0%            |
| Filter Reso   | -100 – 0 – 100%  | 0%            |
| Gate Attack   | 0–100%   | 25%           |
| Gate Hold     | 0–100%   | 50%           |
| Gate Release  | 0–100%   | 25%           |
| Mod LFO Wave  | Random; 2–12, 16, 24, 32, 48, 64, 96, 128, 192, 256 Steps  | Random        |
| Mod Env       | -100 – 0 – 100%  | 0%            |
| Mod LFO       | 0–100%   | 0%            |

**AIR Filter**

This effect applies a filter to the audio signal and then applies selectable saturation or reduction to the filtered signal.

| Parameter        | Value Range   | Default Value |
|------------------|---|---------------|
| Cutoff Freq      | 55.0 Hz – 20.0 kHz  | 20.0 kHz      |
| Reso Factor      | 0.7 – 20.0  | 1.0           |
| Type             | LP4–1, BP2, BP4, HP2_LP1, HP3_LP1, HP4–1, BR2, BR4, BR2_LP1, BR2_LP2, HP1_BR2, BP2_BR2, HP1_LP2, HP1_LP3, AP3, AP3_LP1, HP1_AP3 | LP4           |
| Output Gain      | -Inf dB – 0.0 dB  | 0.0 dB        |
| Saturation Type  | Resample, Bit Crush, Rectify, Hard Clip, Distort, Overdrive   | Overdrive     |
| Saturation Drive | 0.0 – 12.0 dB   | 0.0 dB        |
| Saturation Mode  | DCF, CVF  | DCF           |

**AIR Kill EQ**

This effect can zap out the Low, Mid or High broadband frequency from an audio signal.

| Parameter  | Value Range       | Default Value |
|------------|-------------------|---------------|
| High       | Thru, Kill        | Thru          |
| Mid        | Thru, Kill        | Thru          |
| Low        | Thru, Kill        | Thru          |
| Output     | -20.0 – +20.0 dB  | 0.0 dB        |
| High Gain  | -Inf – +12.0 dB   | 0.0 dB        |
| Mid Gain   | -Inf – +12.0 dB   | 0.0 dB        |
| Low Gain   | -Inf – +12.0 dB   | 0.0 dB        |
| High Freq. | 500 Hz – 8.00 kHz | 2.00 kHz      |
| Offset     | -100 – +100%      | 0%            |
| Low Freq.  | 50.0 – 800 Hz     | 200 Hz        |

**AIR Para EQ**

This effect is a powerful four-band parametric equalizer with four independent EQ ranges, adjustable Low and High EQ filter types, and dedicated Low Cut and High Cut.

| Parameter       | Value Range         | Default Value |
|-----------------|---------------------|---------------|
| High Freq       | 1.2 – 20.0 kHz      | 6.00 kHz      |
| High Q          |                     |               |
| Shelf           | 0.40 – 2.00         | 1.00          |
| Bell            | 0.40 – 10.00        | 1.00          |
| High Gain       |                     |               |
| Shelf           | -12.0 – +12.0 dB    | 0.0 dB        |
| Bell            | -18.0 – 18.0 dB     | 0.0 dB        |
| High Type       | Shelf, Bell         | Shelf         |
| High Out/In     | Out, In             |               |
| High Mid Freq   | 120 Hz – 16.0 kHz   | 2.00 kHz      |
| High Mid Q      | 0.40 – 10.00        | 1.00          |
| High Mid Gain   | -18.0 – 18.0 dB     | 0.0 dB        |
| High Mid Out/In | Out, In             |               |
| Low Mid Freq    | 40.0 Hz – 16.00 kHz | 247 Hz        |
| Low Mid Q       | 0.40 – 10.00        | 1.00          |
| Low Mid Gain    | -18.0 – 18.0 dB     | 0.0 dB        |
| Low Mid Out/In  | Out, In             |               |
| Low Freq        | 20.0 Hz – 1.00 kHz  | 100 Hz        |
| Low Q           |                     |               |
| Shelf           | 0.40 – 2.00         | 1.00          |
| Bell            | 0.40 – 10.00        | 1.00          |
| Low Gain        |                     |               |
| Shelf           | -12.0 – +12.0 dB    | 0.0 dB        |
| Bell            | -18.0 – 18.0 dB     | 0.0 dB        |
| Low Type        | Shelf, Bell         | Shelf         |

**AIR Para EQ** (continued)

| Parameter       | Value Range        | Default Value |
|-----------------|--------------------|---------------|
| Low Out/In      | Out, In            |               |
| Output          | -20.0 – +20.0 dB   | 0.0 dB        |
| High Cut Freq   | 120 Hz – 20.0 kHz  | 20.0 kHz      |
| High Cut Type   | 6, 12, 18, 24 dB   | 12 dB         |
| High Cut Out/In | Out, In            |               |
| Low Cut Freq    | 20.0 Hz – 8.00 kHz | 100 Hz        |
| Low Cut Type    | 6, 12, 18, 24 dB   | 12 dB         |
| Low Cut Out/In  | Out, In            |               |

**AIR Vintage Filter \***

This effect is a powerful filter plugin for bringing those classic analog filter sounds to your tracks, perfect for synths, guitars plus loads more.

| Parameter  | Value Range              | Default Value |
|------------|--------------------------|---------------|
| Cutoff     | 20.0 Hz – 20.0 kHz       | 878 Hz        |
| Resonance  | 0–100%                   | 0%            |
| Fat        | 0–200%                   | 200%          |
| Mode       | LP24, LP18, LP12, BP, HP | LP18          |
| Attack     | 10.0 ms – 10 s           | 10.0 ms       |
| Release    | 10.0 ms – 10 s           | 966 ms        |
| Env. Depth | -100 – 0 – +100%         | +37%          |
| Sync       | Off, On                  | On            |
| Rate       |                          |               |
| Sync On:   | 16 – 8/4                 | 4T            |
| Sync Off:  | 0.01–10.0 Hz             | 2.54 Hz       |
| LFO Depth  | 0–100%                   | 61%           |
| Output     | -Inf dB – 0.0 dB         | 0.0 dB        |

**HP Filter Sweep**

This effect is a high-pass filter with its cutoff frequency modulated by an LFO.

| Parameter      | Value Range     | Default Value |
|----------------|-----------------|---------------|
| Dry/Wet        | 0–100 (dry–wet) | 80            |
| Low Frequency  | 0–100           | 50            |
| High Frequency | 0–100           | 100           |
| Resonance      | 0–100           | 33            |
| Rate           | 0–100           | 10            |

### HP Filter Sync

This effect is a high-pass filter with its cutoff frequency modulated by an LFO.

| Parameter      | Value Range     | Default Value |
|----------------|-----------------|---------------|
| Dry/Wet        | 0–100 (dry–wet) | 100           |
| Low Frequency  | 0–100           | 0             |
| High Frequency | 0–100           | 100           |
| Resonance      | 0–100           | 50            |
| Rate           | 8 bars – 1/32   | 1/4           |

### HP Filter

This effect is a static filter without modulation.

| Parameter | Value Range | Default Value |
|-----------|-------------|---------------|
| Frequency | 10–19999 Hz | 1500          |
| Resonance | 0–100       | 0             |

### HP Shelving Filter

This filter differs from the standard filter type, as it attenuates all frequencies after the cutoff point equally.

| Parameter | Value Range     | Default Value |
|-----------|-----------------|---------------|
| Frequency | 10–19999 Hz     | 1500          |
| Resonance | 0–100           | 0             |
| Gain      | -18.0 – 18.0 dB | 0.0           |

### LP Filter Sweep

This effect is a low-pass filter with its cutoff frequency modulated by an LFO.

| Parameter      | Value Range     | Default Value |
|----------------|-----------------|---------------|
| Dry/Wet        | 0–100 (dry–wet) | 80            |
| Low Frequency  | 0–100           | 0             |
| High Frequency | 0–100           | 100           |
| Resonance      | 0–100           | 33            |
| Rate           | 0–100           | 10            |

### LP Filter Sync

This effect is a low-pass filter with its cutoff frequency modulated by an LFO.

| Parameter      | Value Range     | Default Value |
|----------------|-----------------|---------------|
| Dry/Wet        | 0–100 (dry–wet) | 100           |
| Low Frequency  | 0–100           | 0             |
| High Frequency | 0–100           | 100           |
| Resonance      | 0–100           | 50            |
| Rate           | 8 bars – 1/32   | 1/4           |

### LP Filter

This effect is a static filter without modulation.

| Parameter | Value Range | Default Value |
|-----------|-------------|---------------|
| Frequency | 10–19999 Hz | 1500          |
| Resonance | 0–100       | 0             |



**LP Shelving Filter**

This filter differs from the standard filter type, as it attenuates all frequencies after the cutoff point equally.

| Parameter | Value Range     | Default Value |
|-----------|-----------------|---------------|
| Frequency | 10–19999 Hz     | 1500          |
| Resonance | 0–100           | 0             |
| Gain      | -18.0 – 18.0 dB | 0.0           |

**PEQ 2-Band, 2-Shelf**

This effect is a combination of one two-band parametric equalizer and two shelving filters.

| Parameter      | Value Range     | Default Value |
|----------------|-----------------|---------------|
| Low Frequency  | 22–1000 Hz      | 220           |
| Frequency 1    | 82–3900 Hz      | 820           |
| Frequency 2    | 220–10000 Hz    | 2200          |
| High Frequency | 560–19999 Hz    | 5600          |
| Q1             | 0–100           | 0             |
| Q2             | 0–100           | 0             |
| Low Gain       | -18.0 – 18.0 dB | 0.0           |
| Gain 1         | -18.0 – 18.0 dB | 0.0           |
| Gain 2         | -18.0 – 18.0 dB | 0.0           |
| High Gain      | -18.0 – 18.0 dB | 0.0           |

**PEQ 4-Band**

This effect is a powerful four-band parametric equalizer with four independent EQ ranges.

| Parameter      | Value Range     | Default Value |
|----------------|-----------------|---------------|
| Low Frequency  | 22–1000 Hz      | 220           |
| Frequency 1    | 82–3900 Hz      | 820           |
| Frequency 2    | 220–10000 Hz    | 2200          |
| High Frequency | 560–19999 Hz    | 5600          |
| Q1             | 0–100           | 5             |
| Q2             | 0–100           | 5             |
| Q3             | 0–100           | 5             |
| Q4             | 0–100           | 5             |
| Gain 1         | -18.0 – 18.0 dB | 0.0           |
| Gain 2         | -18.0 – 18.0 dB | 0.0           |
| Gain 3         | -18.0 – 18.0 dB | 0.0           |
| Gain 4         | -18.0 – 18.0 dB | 0.0           |

**Harmonic**

Options: *AIR Amp Sim*, *AIR Diode Clip*, *AIR Distortion*, *AIR Flavor*, *AIR Freq Shift*, *AIR Lo-Fi*, *AIR Talk Box*, *AIR Tube Drive*, *Decimator*, *Distortion Amp*, *Distortion Custom*, *Distortion Fuzz*, *Distortion Grimey*, *Distortion Overdrive*, *Frequency Shifter*, *Granulator*, *Resampler*, *TouchFX*, *XYFX*

**AIR Amp Sim**

This effect simulates guitar and bass amplifiers with a wide range of available cabinet models and tone shaping options.

| Parameter | Value Range  | Default Value |
|-----------|--|---------------|
| Cab Model | D.I., Brit, 1x8", 1x12", 2x10", 2x12", 4x10", 4x12", 1x15" Bass, 4x10" Bass, Radio | 4x10"         |
| Drive     | 0.0–11.0   | 0.0           |
| Mode      | Mono, Stereo   | Stereo        |
| Output    | -12.0 – 0.0 – +12.0 dB   | 0.0 dB        |
| Soft Clip | 0–100%   | 0%            |
| Top Boost | 0–100%   | 0%            |
| Bias      | 0–100%   | 0%            |
| Bass      | -12.0 – 0.0 – +12.0 dB   | -12.0 dB      |
| Mid       | -12.0 – 0.0 – +12.0 dB   | 0.0 dB        |
| Mid Freq  | 250 Hz – 4.00 kHz  | 1.00 kHz      |
| Treble    | -12.0 – 0.0 – +12.0 dB   | 0.0 dB        |

**AIR Diode Clip**

This is a distortion effect that can be used for anything from adding subtle grit to drum breaks to aggressive distorted mayhem.

| Parameter    | Value Range           | Default Value |
|--------------|-----------------------|---------------|
| Input HP     | 200 – 800 Hz          | 500 Hz        |
| Env Speed    | 0–100%                | 50%           |
| Output HP    | 1000 – 4000 Hz        | 2000 Hz       |
| Output LP    | 1000 – 12000 Hz       | 6000 Hz       |
| Wide         | Off, On               | Off           |
| Solo         | Off, On               | Off           |
| Oversampling | Off, On               | On            |
| Level        | -inf – 0.0 – +12.0 dB | 0.0 dB        |

**AIR Distortion**

This effect is a multi-type distortion that adds color to your audio signal with varying types and amounts of distortion.

| Parameter        | Value Range       | Default Value |
|------------------|-------------------|---------------|
| Mode             | Hard, Soft, Wrap  | Hard          |
| Drive            | 0 – 60 dB         | 15 dB         |
| Output           | 0–100%            | 100%          |
| Mix              | 0–100% (dry-wet)  | 100%          |
| Tone Pre-Shape   | -100 – 0 – +100%  | 0%            |
| Tone High Cut    | 1.00 – 20.0 kHz   | 20.0 kHz      |
| Stereo           | On, Off           | Off           |
| Clipping Thresh. | -20.0 – 0.0 dB FS | -10.0 dB FS   |
| Clipping Edge    | 0–100%            | 0%            |

**AIR Flavor**

This effect applies EQ simulations of radios, phones, tape machines, and more to dramatically change the timbre of your sound.

| Parameter        | Value Range | Default Value |
|------------------|-------------|---------------|
| Timbre           | Varies      | Neutral       |
| Timbre Depth     | 0–100%      | 100%          |
| Vinyl Distortion | 0–100%      | 0%            |
| Vinyl Noise      | 0–100%      | 0%            |
| Flutter          | 0–100%      | 0%            |
| Monofy           | 0–100%      | 0%            |

**AIR Freq Shift**

This effect shifts the audio signal's individual frequencies for unique effects.

| Parameter | Value Range                 | Default Value |
|-----------|-----------------------------|---------------|
| Mode      | Up, Down, Up & Down, Stereo | Up            |
| Frequency | 10.0 mHz – 10.0 kHz         | 316 mHz       |
| Feedback  | 0–100%                      | 0%            |
| Mix       | 0–100% (dry-wet)            | 100%          |

**AIR Lo-Fi**

This effect is used to bit-crush, down-sample, clip, rectify and mangle an audio signal.

| Tab       | Parameter   | Value Range                                | Default Value    |           |
|-----------|-------------|--|------------------|-----------|
| Lo-Fi     | Bit Depth   | 1.0 – 16.0 bit                             | 16.0 bit         |           |
|           | Sample Rate | 500 Hz – 50.0 kHz                          | 50.0 kHz         |           |
|           | Mix         | 0–100%                                     | 100%             |           |
|           | Distortion  | Clip                                       | 0.0 – 40.0 dB    | 0.0 dB    |
|           |             | Rectify                                    | 0–100%           | 0%        |
|           |             | Noise Mod                                  | 0–100%           | 0%        |
|           | Anti-Alias  | Pre  | 0.125 – 2.000 Fs | 0.5000 Fs |
|           |             | Post                                       | 0.125 – 2.000 Fs | 1.000 Fs  |
|           |             | Enable                                     | On, Off          | Off       |
| LFO / Env | Wave        | Sine, Tri, Saw, Square, Morse, S&H, Random | Sine             |           |
|           | Rate        |  |                  |           |
|           | Sync Off:   | 0.01 – 10.0 Hz                             | 1.00 Hz          |           |
|           | Sync On:    | 8/4 – 16                                   | 2T               |           |
|           | Sync        | On, Off                                    | Off              |           |
|           | Depth       | -100 – 0 – 100%                            | 0%               |           |
|           | Attack      | 0.1 – 10.0 s                               | 0.5 s            |           |
|           | Release     | 0.1 – 10.0 s                               | 0.5 s            |           |
|           | Depth       | -100 – 0 – 100%                            | 0%               |           |

**AIR Talk Box**

This effect adds voice-like resonances to audio signals.

| Parameter   | Value Range  | Default Value |
|-------------|--|---------------|
| Vowel       | OO, OU, AU, AH, AA, AE, EA, EE, EH, ER, UH, OH, OO | AH            |
| Env Depth   | -100 – 0 – +100%                                   | 0%            |
| Formant     | -12.00 – +12.00                                    | 0.00          |
| Mix         | 0–100%   | 100%          |
| LFO Wave    | Sine, Tri, Saw, Square, S&H, Random                | Sine          |
| LFO Rate    |  |               |
| Sync Off:   | 0.01 – 10.0 Hz                                     | 1.00 Hz       |
| Sync On:    | 8/4 – 16   | 2T            |
| LFO Sync    | Off, On  | Off           |
| LFO Depth   | -100 – 0 – +100%                                   | 0%            |
| Env Thresh  | -60.0 – 0.0 dB                                     | -30.0 dB      |
| Env Attack  | 0.1 – 10.0 s                                       | 0.5 s         |
| Env Release | 0.1 – 10.0 s                                       | 0.5 s         |

### AIR Tube Drive

This effect is designed to reproduce the sound of an overdriven tube amplifier.

| Parameter  | Value Range      | Default Value |
|------------|------------------|---------------|
| Drive      | 0–100%           | 0%            |
| Headroom   | -30.0 – 0.0 dB   | -15.0 dB      |
| Saturation | 0–100%           | 50%           |
| Output     | -20.0 – +20.0 dB | 0.0 dB        |

### Decimator

Decimator down-samples the incoming signal by removing bits from the digital signal. The difference between decimation and resampling is that Decimator does not use any filtering to mask or correct digital artifacts. The result is an effect ranging from mild to almost completely pure digital distortion, depending on the setting and the source material.

| Parameter   | Value Range     | Default Value |
|-------------|-----------------|---------------|
| Dry/Wet     | 0–100 (dry–wet) | 100           |
| Decimate    | 0–100           | 0             |
| Bit Reducer | 4–32            | 32            |

### Distortion Amp

This effect is designed to reproduce the sound of a tube amplifier at high volumes.

| Parameter | Value Range     | Default Value |
|-----------|-----------------|---------------|
| Dry/Wet   | 0–100 (dry–wet) | 100           |
| Drive     | 0–100           | 50            |
| Tone      | 0–100           | 50            |
| Dynamics  | 0–100           | 50            |
| Output    | 0–100           | 50            |

### Distortion Custom

This effect is a highly customized distortion, capable of a wide range of useable sounds.

| Parameter | Value Range     | Default Value |
|-----------|-----------------|---------------|
| Dry/Wet   | 0–100 (dry–wet) | 100           |
| Drive     | 0–100           | 50            |
| +Soft     | 5–75            | 2             |
| +Clip     | 5–50            | 25            |
| –Soft     | 5–75            | 2             |
| –Clip     | 5–50            | 25            |
| Low       | -18.0 – 18.0 dB | 0.0           |
| Mid       | -18.0 – 18.0 dB | 0.0           |
| High      | -18.0 – 18.0 dB | 0.0           |
| Output    | -18.0 – 18.0 dB | 50            |

### Distortion Fuzz

This popular effect uses hard clipping of the audio signal, which, at extreme settings, can turn a standard waveform into a square wave, producing a “razor” effect.

| Parameter | Value Range     | Default Value |
|-----------|-----------------|---------------|
| Dry/Wet   | 0–100 (dry–wet) | 100           |
| Drive     | 0–100           | 50            |
| Output    | 0–100           | 50            |
| Low       | 0–100           | 50            |
| Low-Mid   | 0–100           | 50            |
| High-Mid  | 0–100           | 50            |
| High      | 0–100           | 50            |

### Distortion Grimey

This is a unique distortion effect that distorts a frequency range in a selectable band.

| Parameter | Value Range     | Default Value |
|-----------|-----------------|---------------|
| Dry/Wet   | 0–100 (dry–wet) | 100           |
| Drive     | 0–100           | 50            |
| Grime     | 0–100           | 50            |
| Center    | 0–100           | 50            |
| Width     | 0–100           | 50            |
| Resonance | 0–100           | 50            |
| Output    | 0–100           | 50            |

### Distortion Overdrive

This distortion is designed to sound like a mildly distorting amplifier at medium volumes. It is the smoothest distortion type available.

| Parameter | Value Range     | Default Value |
|-----------|-----------------|---------------|
| Dry/Wet   | 0–100 (dry–wet) | 100           |
| Drive     | 0–100           | 50            |
| Tone      | 0–100           | 50            |
| Output    | 0–100           | 50            |

### Frequency Shifter

A frequency shifter changes the frequencies of an input signal by a fixed amount and alters the relationship of the original harmonics. This can produce a chorus-like effect as well as very crazy artificial timbres.

| Parameter  | Value Range     | Default Value |
|------------|-----------------|---------------|
| Dry/Wet    | 0–100 (dry–wet) | 100           |
| Frequency  | -1000 – 1000    | 0             |
| Asynchrony | 0–1000          | 0             |
| A Pan      | 0–100           | 0             |
| B Pan      | 0–100           | 100           |
| A Gain     | 0–100           | 75            |
| B Gain     | 0–100           | 75            |

## Granulator

This effect turns your incoming audio into small grains of sound that can be looped, pitch shifted, and manipulated in new and interesting ways.

| Parameter             | Value Range                  | Default Value   |
|-----------------------|------------------------------|-----------------|
| Grain Density         | 1.0–300.0 grains/sec         | 68.0 grains/sec |
| Grain Window          | 20.0–1000.0 ms               | 608.0 ms        |
| Grain Length          | 10.0–200.0 ms                | 171.9 ms        |
| Grain Feedback        | -99.9 – 0.0 – 99.9%          | 0.0%            |
| Trigger Randomization | 0–100%                       | 0.0%            |
| Pitch Randomization   | 0–100%                       | 0.0%            |
| Pitch                 | -12.0 – 0.0 – 12.0 semitones | 0.0 semitones   |
| Fine                  | -50.0 – 0.0 – 50.0%          | 0.0%            |
| Stereo                | 0–100%                       | 0.0%            |
| Mix                   | 0–100%                       | 34.6%           |
| Freeze                | Off, On                      | Off             |

## Resampler

Resampler is similar to [Decimator](#) in that it removes bits from an incoming signal. The difference is that Resampler applies a complex suite of filters and anti-aliasing to attempt to retain the original sound quality. This is a method used by popular vintage samplers and sampling drum machines from the 1980s. Resampler can be used to achieve a “dirty” sound on drum loops, without the harshness of distortion.

| Parameter | Value Range     | Default Value |
|-----------|-----------------|---------------|
| Dry/Wet   | 0–100 (dry–wet) | 100           |
| Rate      | 0–100           | 0             |
| Decimate  | 0–100           | 0             |

## TouchFX

See [Addenda > Updates in MPC 2.10.1 > New Features > Touch Strip and Touch FX](#) for more information.

## XYFX

See [Operation > Modes > XYFX Mode](#) for more information.

## Modulation

Options: *AIR Chorus\**, *AIR Ensemble*, *AIR Flanger*, *AIR Fuzz-Wah*, *AIR Half Speed*, *AIR Multi-Chorus*, *AIR Phaser*, *AIR Pitch Shifter*, *AIR Stereo Width*, *AIR Stutter*, *Auto Wah*, *Autopan Sync*, *Autopan*, *Chorus 2-Voice*, *Chorus 4-Voice*, *Flanger Sync*, *Flanger*, *Phaser 1*, *Phaser 2*, *Phaser Sync*, *Tremolo Sync*, *Tremolo*

### AIR Chorus \*

This effect is a compact but powerful plugin for classic chorus warmth and depth.

| Parameter | Value Range          | Default Value |
|-----------|----------------------|---------------|
| Rate      | 0.01 – 10.0 Hz       | 1.01 Hz       |
| Depth     | 0.00 – 24.00 ms      | 7.10 ms       |
| Mix       | 0–100%               | 50%           |
| Feedback  | 0–100%               | 0%            |
| Pre-Delay | 0.00–24.00 ms        | 2.00 ms       |
| Wave      | Triangle, Sine       | Sine          |
| Offset    | -180 – 0 – +180 deg. | +90 deg.      |

### AIR Ensemble

This effect applies fluid, shimmering modulation effects to the audio signal.

| Parameter    | Value Range      | Default Value |
|--------------|------------------|---------------|
| Rate         | 0.01 – 10.0 Hz   | 1.00 Hz       |
| Depth        | 0.00 – 24.00 ms  | 6.00 ms       |
| Width        | 0–100%           | 100%          |
| Mix          | 0–100% (dry–wet) | 75%           |
| Mod. Delay   | 0.00 – 24.00 ms  | 0.00 ms       |
| Mod. Shimmer | 0–100%           | 50%           |

### AIR Flanger

This effect applies a short, modulating delay to the audio signal.

| Parameter | Value Range       | Default Value |
|-----------|-------------------|---------------|
| Rate      | 0.02 – 10.00 Hz   | 0.40 Hz       |
| Depth     | 0–100%            | 50%           |
| Feedback  | 0–100%            | 50%           |
| Mix       | 0–100% (dry–wet)  | 50%           |
| Headroom  | -20.0 – 0.0 dB FS | -10.0 dB FS   |



**AIR Fuzz Wah**

This is a multi-effect that combines transistor-like distortion and wah.

| Tab        | Parameter       | Value Range                 | Default Value |
|------------|-----------------|-----------------------------|---------------|
| Fuzz-Wah   | Mix             | 0–100% (dry–wet)            | 100%          |
|            | Order           | Fuzz>Wah, Wah>Fuzz          | Fuzz>Wah      |
|            | Fuzz Mix        | 0–100% (dry–wet)            | 100%          |
|            | Wah Mix         | 0–100% (dry–wet)            | 100%          |
|            | Fuzz Drive      | 0 – 40 dB                   | 20 dB         |
|            | Fuzz Tone       | 1.00 – 10.0 kHz             | 3.16 kHz      |
|            | Fuzz Output     | -Inf – 0.0 dB               | 0.0 dB        |
|            | Fuzz Enable     | Off, On                     | Off           |
|            | Wah Pedal       | 0–100%                      | 50%           |
|            | Wah Filter Mode | Lowpass, Bandpass, Highpass | Bandpass      |
|            | Min. Freq.      | 50.0 Hz – 4.00 kHz          | 428 Hz        |
|            | Max Freq.       | 50.0 Hz – 4.00 kHz          | 2.07 kHz      |
|            | Min. Resonance  | 0–100%                      | 55%           |
|            | Max Resonance   | 0–100%                      | 33%           |
|            | Wah Enable      | Off, On                     | On            |
| Modulation | Mode            | LFO, Env                    | LFO           |
|            | Rate            |                             |               |
|            | LFO             | 8/4 – 16                    | 4T            |
|            | Env             | 0–100%                      | 75%           |
|            | Depth           | -100 – 0 – 100%             | 0%            |

**AIR Half Speed**

This effect can quickly create half-speed versions from any input material. Filter the processed audio using the built-in high pass and low pass filter to create dramatic transitions, and use the fade in and fade out parameters to create synchronized transitions between dry and effected audio.

| Parameter   | Value Range             | Default Value |
|-------------|-------------------------|---------------|
|             | Start, Stop             |               |
| Loop Length | 1/16 – 4 Bars           | 1 Bar         |
| Mode        | *1.5, *2, *4            | *2            |
| Mix         | 0–100%                  | 100%          |
| Loop Fade   | 1.00 – 200 ms           | 4.90 ms       |
| Fade In     | Hard, Soft, 1/16–4 Bars | Hard          |
| Fade Out    | Hard, Soft, 1/16–4 Bars | Hard          |
| HPF         | Off, 20.0 Hz – 20.0 kHz | Off           |
| LPF         | 20.0 Hz – 19.9 kHz, Off | Off           |
| Band        | Off, On                 | Off           |

### AIR Multi-Chorus

This effect applies a thick, complex chorus effect to your audio signal.

| Parameter      | Value Range        | Default Value |
|----------------|--------------------|---------------|
| Rate           | 0.01 – 10.0 Hz     | 1.00 Hz       |
| Depth          | 0.00 – 24.00 ms    | 6.00 ms       |
| Voices         | 3, 4, 6            | 4             |
| Mix            | 0–100% (dry–wet)   | 50%           |
| Chorus Low Cut | 20.0 Hz – 1.00 kHz | 20.0 Hz       |
| Chorus Width   | 0–100%             | 100%          |
| Mod Wave       | Sine, Tri          | Tri           |
| Mod Delay      | 0.00 – 24.00 ms    | 6.0 ms        |

### AIR Phaser

This effect applies a phaser to your audio signal, for that wonderful "wooshy," "squishy" sound.

| Parameter    | Value Range                | Default Value |
|--------------|----------------------------|---------------|
| Rate         | 0.10 – 10.00 Hz            | 1.00 Hz       |
| Depth        | 0–100%                     | 50%           |
| Feedback     | 0–100%                     | 0%            |
| Mix          | 0–100% (dry–wet)           | 50%           |
| Phaser Model | Vibe, Stone, Ninety, Tron, | Ninety        |
| Offset       |                            |               |
| Phase        | -180 – +180 deg.           | 0 deg.        |
| Rate         | 25–400%                    | 100%          |
| Type         | Phase, Rate                | Phase         |

### AIR Pitch Shifter

This effect alters the pitch of the audio signal and can be adjusted based on the source or style of the signal.

| Parameter | Value Range                          | Default Value |
|-----------|--------------------------------------|---------------|
| Mode      | Vocal, Bass, Beats, Chords, Textures | Vocal         |
| Shift     | -24.0 – 0 – 24.0                     | 0.0           |
| Mix       | 0–100%                               | 100%          |

### AIR Stereo Width

This effect creates a wider stereo presence in an audio signal.

| Parameter  | Value Range           | Default Value |
|------------|-----------------------|---------------|
| Width      | 0–200%                | 100%          |
| Delay      | 0.0 – 8.0 ms          | 0.0 ms        |
| Level Trim | -Inf – 0.0 – +12.0 dB | 0.0 dB        |
| Pan Trim   | L100 – <C> – R100     | <C>           |
| High       | 0–200%                | 100%          |
| Mid        | 0–200%                | 100%          |
| Low        | 0–200%                | 100%          |

## AIR Stutter

This effect creates mind-blowing glitch effects using a wide range of volume, pan and pitch stutter effects.

| Parameter   | Value Range          | Default Value |
|-------------|----------------------|---------------|
| Intervals   | 1/64 – ¼             | 1/16          |
| Sync        | Off, On              | On            |
| Steps       | 2–64                 | 5             |
| Step Length | 0–100%               | 100%          |
| Freeze      | Off, On              | Off           |
| Decay       | 50.0 ms – 100 s      | 6.99 s        |
| Volume      | -12.0 – 0.0 – 6.0 dB | -1.2 dB       |
| Mix         | 0–100%               | 100%          |
| Pan Mod     | 0–100%               | 50%           |
| Pitch Mod   | -100 – 0 – +100%     | 0%            |

## Auto Wah

This effect is a low-pass filter modulated by an envelope that yields a classic funky “wah-wah”- like sound. The envelope is triggered by the incoming signal’s amplitude. The amount of the envelope on the cutoff frequency is user-definable.

| Parameter   | Value Range     | Default Value |
|-------------|-----------------|---------------|
| Dry/Wet     | 0–100 (dry–wet) | 100           |
| Resonance   | 0–100           | 75            |
| Attack      | 0–100           | 30            |
| Release     | 0–100           | 30            |
| Center      | 0–100           | 50            |
| Sensitivity | 0–100           | 50            |

## Autopan Sync

This effect uses an LFO (tempo-synced to your project) to move the incoming signal back and forth across the stereo field, creating a rotary effect.

| Parameter | Value Range     | Default Value |
|-----------|-----------------|---------------|
| Dry/Wet   | 0–100 (dry–wet) | 100           |
| Rate      | 8 bars – 1/32   | 1/4           |

## Autopan

This effect uses an LFO to move the incoming signal back and forth across the stereo field, creating a rotary effect.

| Parameter | Value Range     | Default Value |
|-----------|-----------------|---------------|
| Dry/Wet   | 0–100 (dry–wet) | 100           |
| Rate      | 0–100           | 10            |

## Chorus 2-Voice

This effect uses an LFO to modulate the pitch and a delay of the input signal, which are then added to the dry signal. In small amounts, this creates the illusion of multiple voices playing at once. Turn up the **Feedback** and **Amount** for more pronounced “shimmering” and “watery” sounds.

| Parameter | Value Range     | Default Value |
|-----------|-----------------|---------------|
| Dry/Wet   | 0–100 (dry–wet) | 100           |
| Delay     | 0–100           | 20            |
| Amount    | 0–100           | 80            |
| Width     | 0–100           | 80            |
| Feedback  | 0–100           | 50            |
| Rate      | 0–100           | 10            |

### Chorus 4-Voice

This effect is the same as Chorus 2-Voice, but adds additional voices for more pronounced modulation.

| Parameter | Value Range     | Default Value |
|-----------|-----------------|---------------|
| Dry/Wet   | 0–100 (dry–wet) | 100           |
| Delay     | 0–100           | 20            |
| Amount    | 0–100           | 80            |
| Width     | 0–100           | 80            |
| Feedback  | 0–100           | 50            |
| Rate      | 0–100           | 10            |

### Flanger Sync

This effect is the same as Flanger, but syncs to your project tempo.

| Parameter | Value Range            | Default Value |
|-----------|------------------------|---------------|
| Dry/Wet   | 0–100 (dry–wet)        | 100           |
| Rate      | 8 bars – 1/16 triplets | 1/4           |
| Feedback  | -100 – 100             | 0             |
| Delay     | 0–100                  | 20            |
| Width     | 0–100                  | 80            |

### Flanger

A flanger is a modulated delay to emulate the sound created when running two analog tape machines in parallel with a slight time misalignment. Slow **Rate** settings can produce a “whooshing” jet engine sound, while faster rates result in more of a “warble.”

| Parameter | Value Range     | Default Value |
|-----------|-----------------|---------------|
| Dry/Wet   | 0–100 (dry–wet) | 100           |
| Rate      | 0–100           | 10            |
| Feedback  | -100 – 100      | 0             |
| Delay     | 0–100           | 20            |
| Width     | 0–100           | 80            |

### Phaser 1

This effect applies multiple ganged all-pass filters to create “notches,” or sharp spikes, in the frequency spectrum. The frequencies of these all-pass filters are usually modulated by an LFO to create a sweeping sound.

| Parameter | Value Range     | Default Value |
|-----------|-----------------|---------------|
| Dry/Wet   | 0–100 (dry–wet) | 100           |
| Rate      | 0–100           | 10            |

### Phaser 2

This effect is a variation on Phaser 1.

| Parameter | Value Range     | Default Value |
|-----------|-----------------|---------------|
| Dry/Wet   | 0–100 (dry–wet) | 100           |
| Rate      | 0–100           | 10            |

### Phaser Sync

This effect is similar to Phaser 1/Phaser 2, but the LFO is synced to the project tempo..

| Parameter | Value Range           | Default Value |
|-----------|-----------------------|---------------|
| Dry/Wet   | 0–100 (dry–wet)       | 100           |
| Rate      | 1 bar – 1/16 triplets | 1/4           |

## Tremolo Sync

This effect uses an LFO (synced to project tempo) to increase and decrease the volume of the signal. Depending on the LFO shape, this can produce a smooth wave effect (sine wave) or a stuttering “on-off” effect (square wave).

| Parameter      | Value Range           | Default Value |
|----------------|-----------------------|---------------|
| Dry/Wet        | 0–100 (dry–wet)       | 100           |
| Rate           | 1 bar – 1/16 triplets | 1/4           |
| Sine to Square | 0–100 (sine–square)   | 0             |

## Tremolo

This effect is the same as Tremolo sync, but the LFO is not synced to project tempo.

| Parameter      | Value Range         | Default Value |
|----------------|---------------------|---------------|
| Dry/Wet        | 0–100 (dry–wet)     | 100           |
| Rate           | 0–100               | 10            |
| Sine to Square | 0–100 (sine–square) | 0             |

## Vocal

Options: [AIR Vocal Doubler](#), [AIR Vocal Harmonizer](#), [AIR Vocal Tuner](#)

### AIR Vocal Doubler

This effect creates realistic vocal doubles to add width or thickness to a vocal line.

| Parameter      | Value Range    | Default Value |
|----------------|----------------|---------------|
| Voices         | 1–8            | 4             |
| Stereo Spread  | 0–100%         | 70%           |
| Lead Volume    | -Inf – +6.0 dB | 0.0 dB        |
| Doubler Volume | -Inf – +6.0 dB | 0.0 dB        |
| Pitch          | +/- 0–250%     | +/- 38%       |
| Pitch Speed    | 0–100%         | 75%           |
| Timing         | 0–800 ms       | 63 ms         |

**AIR Vocal Harmonizer**

This effect can create up to four-part realistic vocal harmonies and complex doubling effects. Each vocal part has its own level, delay, formant, mode and interval parameters.

| Parameter       | Value Range   | Default Value |
|-----------------|---|---------------|
| Key             | A–G#  | C             |
| Scale           | Major, Minor, Harm Minor, Melo Minor, Dorian, Phrygian, Lydian, Mixo, Locrian, Chromatic, Penta, Maj Triad, Min Triad, Root | Major         |
| Lead Volume     | -Inf – 0.0 dB   | 0.0 dB        |
| Harmony Volume  | -Inf – 0.0 dB   | -2.5 dB       |
| Timing          | 0–100%  | 42%           |
| Tuning          | 0–100%  | 14%           |
| Smooth          | 5–200 ms  | 8 ms          |
| Voice Range     | Very Low, Low, Mid, High, Very High   | Mid           |
| Root Mode Split | A–G#  | E             |
| Reference       | 420.0–460.0 Hz  | 440.0 Hz      |
| Delay Sync      | Off, On   | On            |
| Harmony 1–4     | Off, On   | 1 On          |

**AIR Vocal Tuner**

This effect applies pitch correction for natural sounding or hard-tuned vocal effects.

| Parameter   | Value Range   | Default Value |
|-------------|---|---------------|
| Detection   | Unworried, Default, Selective, Picky, Blind   | Default       |
| Voice Range | Very Low, Low, Mid, High, Very High   | Mid           |
| Key         | A–G#  | A             |
| Scale       | Major, Minor, Harm Minor, Melo Minor, Dorian, Phrygian, Lydian, Mixo, Locrian, Chromatic, Penta, Maj Triad, Min Triad, Root | Minor         |
| Retune Time | 1–1000 ms   | 32 ms         |
| Reference   | 420.0–460.0 Hz  | 440.0 Hz      |

## Glossary

This glossary briefly defines and explains many of the technical terms used throughout this manual.

- Aftertouch** The majority of contemporary keyboards are capable of generating aftertouch messages. On this type of keyboard, when you press harder on a key you are already holding down, a MIDI aftertouch message is generated. This feature makes sounds even more expressive (e.g., through vibrato).
- Aliasing** Aliasing is an audible side effect arising in digital systems as soon as a signal contains harmonics higher than half the sampling frequency.
- Amount** Describes to which extent a modulation source influences a given parameter.
- Amplifier** An amplifier is a component that influences the volume level of a sound via a control signal. It can be modulated by a control signal (e.g., generated by an *envelope* or an *LFO*).
- Attack** An *envelope* parameter. This term describes the ascent rate of a time-relevant process (e.g., an envelope from its starting point to the point where it reaches its highest value). The attack phase is initiated immediately after a trigger signal is received (e.g., after you play a note on a trigger pad or a keyboard).
- Bit Rate** Bit rate (also known as **word length**), is the number of bits used to store the level information of each single sample slice within a whole sample. The higher the bit rate, the more precise the information about a sample (i.e., its dynamics' resolution). Normal audio CDs are 16-bit. The MPC hardware supports full 24-bit resolution.
- Bounce** When you “bounce” a sequence, track, or program, you are rendering that part of your project as an audio file (as opposed to a MIDI file). The MPC hardware lets you bounce sequences, tracks, or programs as **samples** (saved to your project's sample pool) or as full **audio tracks** (saved to your project's sample pool **and** added directly to the current sequence).
- Bouncing a **track** will render that track after it is sent through its program. Bouncing a **program** will render all tracks that use that program after they are sent through it. Bouncing a **sequence** will render all tracks in that sequence after they are sent through their respective programs.
- Clipping** Clipping is a sort of distortion that occurs when a signal exceeds the maximum value that can be handled by a signal processing system it is fed into. The curve of a clipped signal is dependent on the system where the clipping occurs. In the analog domain, clipping effectively limits the signal to a given maximum level. In the digital domain, clipping is similar to a numerical overflow, resulting in negative polarity of the signal's portions exceeding the maximum level.
- Control Change** MIDI messages enable you to manipulate the behavior of a sound generator to a significant degree. This message essentially consists of two components:  
(Controllers)
- The controller number, which defines the parameter to be influenced. It can range from **0** to **127**.
  - The controller value, which determines the extent of the modification.
- Controllers can be used for effects such as slowly swelling vibrato, changing the stereo panning position and influencing filter frequency.
- Cutoff** The cutoff frequency is a significant factor for a *filter*. A low-pass filter for example dampens the portion of the signal that lies above this frequency. Frequencies below this value are allowed to pass through without being processed.

- CV** stands for **control voltage**, an analog method of sending control messages to external synthesizers, drum machines, etc. CV messages are typically used in conjunction with **Gate** messages (CV messages determine the pitch of notes while Gate messages determine note activation and length). CV messages are sent from the CV out ports of your MPC hardware and to the CV in ports of your external MIDI device.
- Please note that each external MIDI device uses a specific control voltage range, which determines how many volts are used in each octave (e.g., **1V/oct**). Be mindful of this when setting it up with the MPC software and/or controller hardware—mismatched voltage ranges can produce unusual/undesirable “re-scaling” of the octaves.
- Decay** Decay describes the descent rate of an **envelope** once the attack phase has reached its maximum and the envelope drops to the level defined by the sustain value.
- Envelope** An envelope is used to modulate a sound-shaping component within a given time. For instance, an envelope that modulates the cutoff frequency of a filter opens and closes this filter over a period of time. An envelope is started via a trigger, usually a MIDI note.
- The classic **ADSR** envelope consists of four individually variable phases: **attack**, **decay**, **sustain**, and **release**. Attack, decay and release are time or slope values, while sustain is an adjustable level. Once an incoming trigger is received, the envelope runs through the attack and decay phases until it reaches the programmed sustain level. This level remains constant until the trigger is terminated. The envelope then initiates the release phase until it reaches the minimum value.
- You can see and read about the envelopes used in MPC hardware in [Operation > Modes > Program Edit Mode > Anatomy of an Envelope](#).
- Filter** A filter is a component that allows some of a signal’s frequencies to pass through it and dampens other frequencies. The most important aspect of a filter is the filter cutoff frequency. Filters generally come in four categories: **low-pass**, **high-pass**, **band-pass**, and **band-stop**. These are the available filters:
- A **low-pass** filter (the most common type) dampens all frequencies above the cutoff frequency.
  - A **high-pass** filter in turn dampens the frequencies below the cutoff.
  - A **band-pass** filter allows only those frequencies around the cutoff frequency to pass. All others are dampened.
  - A **band-stop** filter does the opposite of a band-pass: it dampens only the frequencies around the cutoff frequency.
  - A **band-boost** filter boosts the frequencies around the cutoff frequency, similar to what a band on an equalizer would do. All other frequencies pass through normally.
- The number of **poles** in a filter’s “slope” determines how extreme or subtle the effect of the filter will be. Filters with one or two poles produce a subtler sound while filters with six or eight poles are much more pronounced.
- The **Model** filters are analog-style emulations of famous vintage synth filters. **Model1** is a four-pole filter that distorts at high input levels. **Model2** uses a mellow resonance with a “fattening” distortion in the lower frequencies. **Model3** can produce howling, piercing resonances and extreme sub frequencies—watch your speakers!
- The **Vocal** filters are formant filters that emulate the human voice. **Vocal1** produces “ah” and “ooh” vowel sounds. **Vocal2** uses three bands to produce “oh” and “ee” vowel sounds. **Vocal3** uses five bands to emulate an idealized model of the vocal tract.
- MPC3000 LPF** is a dynamic, resonant low-pass filter (12 dB/oct) that was used on the original MPC3000, released in 1994.
- Please also see the entry for [Resonance](#), an essential characteristic of a filter’s sound.
- Gate** **Gate** messages are analog messages sent to external synthesizers, drum machines, etc. Gate messages are typically used in conjunction with **CV** messages (CV messages determine the pitch of notes while Gate messages determine note activation and length). Gate messages are sent from the CV out ports of your MPC hardware and to the CV/Gate in ports of your external MIDI device.



- LFO** **LFO** is an acronym for **low-frequency oscillator**. The LFO generates a periodic oscillation at a low frequency and features variable waveshapes. Similar to an envelope, an LFO can be used to modulate a sound-shaping component.
- MIDI** **MIDI** stands for **musical instrument digital interface**. Developed in the early 1980s, MIDI enables interaction between various types of electronic music instruments from different manufacturers. At the time a communications standard for heterogeneous devices did not exist, so MIDI was a significant advance. It made it possible to link various devices with one another through simple, standardized connectors.
- Essentially, this is how MIDI works: One sender is connected to one or several receivers. For instance, if you want to use a computer to play a MIDI synthesizer, the computer is the sender and the synthesizer acts as the receiver. With a few exceptions, the majority of MIDI devices are equipped with two or three ports for this purpose: MIDI In, MIDI Out and in some cases MIDI Thru. The sender transfers data to the receiver via the MIDI Out jack. Data are sent via a cable to the receiver's MIDI In jack.
- MIDI Thru has a special function. It allows the sender to transmit to several receivers. It routes the incoming signal to the next device without modifying it. Another device is simply connected to this jack, thus creating a chain through which the sender can address a number of receivers. Of course, it is desirable for the sender to be able to address each device individually. To achieve this, a MIDI channel message is sent with each MIDI event.
- MIDI Channel** This is a very important element of most messages. A receiver can only respond to incoming messages if its receive channel is set to the same channel as the one the sender is using to transmit data. Subsequently, the sender can address specific receivers individually. MIDI Channels 1–16 are available for this purpose.
- MIDI Clock** The MIDI clock message transmits real-time tempo information to synchronize processes among several connected devices (e.g., a sound generator's delay time to a MIDI sequencer).
- Note:** Audio recording is disabled when receiving MIDI Clock sync. Use MIDI Time Code to record audio while receiving MIDI sync.
- Modulation** A modulation influences or changes a sound-shaping component via a modulation source. Modulation sources include envelopes, LFOs or MIDI messages. The modulation destination is a sound-shaping component such as a filter or a VCA.
- Note On & Note Off** This is the most important MIDI message. It determines the pitch and velocity of a generated note. A note-on message will start a note. Its pitch is derived from the note number, which can range from **0** to **127**. The velocity ranges from **1** to **127**. A velocity value of **0** is equivalent to a note-off message.
- Normalize** Normalization is a function to raise the level of a sample to its maximum (**0 dB**) without causing distortion. This function automatically searches a sample for its maximum level and consequently raises the entire sample's level until the previously determined maximum level reaches 0 dB. In general, this results in a higher overall volume of the sample.
- Panning** The process or the result of changing a signal's position within the stereo panorama.
- Pitch-Bend** Pitch-bend is a MIDI message. Although pitch-bend messages are similar in function to control change messages, they are a distinct type of message. The resolution of a pitch-bend message is substantially higher than that of a conventional controller message. The human ear is exceptionally sensitive to deviations in pitch, so the higher resolution is used because it relays pitch-bend information more accurately.

|                       |   |
|-----------------------|---|
| <b>Program</b>        | <p>A program is a file that contains a list of all samples to be used, and settings for each sample (e.g., pad assignments, loop points, pitch tuning, effects, etc.) Program Edit Mode is where you can edit and assign samples (read more about this in <a href="#">Operation &gt; Modes &gt; Program Edit Mode</a>). You can have a total of <b>128</b> programs in a project.</p> <p>There are three kinds of programs that use samples for their sound source. Drum programs are mostly used for creating drum programs and easy and quick assigning of samples to a pad. With keygroup programs, you can use one sample (or more) and spread it across two or more keys and play the sample chromatically over a keyboard. That way, there is no need to sample every key of, for instance, a piano. Clip programs use several samples that can be looped (clips), each of which can be assigned to a pad; launching different combinations of clips together lets you create intriguing, layered performances.</p> |
| <b>Program Change</b> | <p>These are MIDI messages that select sound programs. Programs <b>1–128</b> can be changed via program change messages.</p>  |
| <b>Release</b>        | <p>An <a href="#">envelope</a> parameter. This term describes the descent rate of an envelope to its minimum value after a trigger is terminated. The release phase begins immediately after the trigger is terminated, regardless of the envelope's current status. For instance, the release phase may be initiated during the attack phase.</p>  |
| <b>Resonance</b>      | <p>Resonance or emphasis is an important <a href="#">filter</a> parameter. It emphasizes the frequencies around the filter cutoff frequency by amplifying them with a narrow bandwidth. This is one of the most popular methods of manipulating sounds. If you increase the emphasis to a level where the filter enters a state of self-oscillation, it will generate a relatively pure sine waveform.</p>  |
| <b>Root Key</b>       | <p>The root key defines the original pitch of a recorded instrument or of a sample. Samples in MPC contain the dedicated root key information. This information will be created automatically during recording or importing.</p>  |
| <b>Sample</b>         | <p>When you tap the pads on your MPC hardware, you can trigger sounds that we call <b>samples</b>. Samples are digitized snippets of audio that can be recorded using the recording (sampling) function of your MPC hardware or loaded from the Browser.</p> <p>You can edit and process a sample in different ways. For example, a sample can be trimmed, looped, pitch-shifted or processed, using various effects. When you have finished editing your sample, you can assign it to one or more drum pads to play it. Samples can be either mono or stereo.</p>  |
| <b>Sample Rate</b>    | <p>This is the frequency representing the amount of individual digital sample scans per second that are taken to capture an analog signal digitally. For normal CD audio recordings, <b>44100</b> samples per second are used, also written as <b>44.1 kHz</b>.</p> <p>You can export audio using sampling rates up to <b>96 kHz</b> (see <a href="#">Operation &gt; General Features &gt; Audio Mixdown</a>) and play audio using <b>44.1 kHz</b>.</p>   |
| <b>Sequence</b>       | <p>A sequence is the most basic “building block” of music you can create within an MPC project. MIDI information from your MPC hardware pads, buttons, and Q-Link knobs are recorded to the tracks of a sequence. Each sequence on your MPC hardware can contain <b>128</b> MIDI tracks and <b>8</b> audio tracks. Each project can store up to <b>128</b> separate sequences.</p> <p>The length of a sequence can be set from <b>1</b> to <b>999</b> bars, which would be enough to create an entire song using only one sequence. However, MPC hardware has a dedicated Song Mode that lets you chain sequences together to create a song.</p>  |
| <b>Song</b>           | <p>Song Mode that allows you to arrange different sections (verse, chorus, hook, etc.) in order to build a song. Each song can have up to <b>999</b> “steps” (stages in which a sequence may play one or more times). Each project can store up to <b>32</b> songs.</p>   |

- Stretch Factor** The stretch factor is a value generated by the **Warp** algorithm in the software. When you record an audio file, the current sequence tempo will be embedded with it. This information is stored within the sample file when you save the project. When you warp an audio track region, the warping algorithm uses this sequence tempo and the current value in the **BPM** field to generate the stretch factor.
- Sustain** This term describes the level of an **envelope** remaining constant after it has passed the attack and decay phases. Once reached, the sustain level is kept until the trigger is terminated.
- Time-Stretch** See **Warp** below.
- Track** A sequence on your MPC hardware can contain **128** MIDI tracks and **8** audio tracks.
- Each **MIDI track** contains MIDI note events and controller data. In this case, the track contains no audio information—only MIDI information that uses the samples in a program (or an external MIDI sound module) to generate its audio. You can edit your performance in many different ways once the performance has been captured.
- Each **audio track** contains an audio signal that has been recorded or imported into your project. You can edit this audio within the software and incorporate it into your sequences alongside your MIDI tracks.
- Trigger** A trigger is a signal that initiates events. Trigger signals are very diverse. For instance, a MIDI note or an audio signal can be used as a trigger. The events a trigger can initiate are also very diverse. A common application for a trigger is its use to start an envelope.
- Warp** The Warp feature lengthens or shortens a region of an audio track or sample without changing its pitch. This enables you to fit the length of an audio track or sample to the length of a sequence, a bar in your sequence, etc. while maintaining its original key.
- Please note that the Warp algorithms are very CPU-intensive and can result in audio drop-outs during playback if used too freely. Be mindful of how (and how often) you use the warp function. You can reduce the CPU resources required by doing any/all of the following:
- Minimize the amount of pitch adjustment of warped audio.
  - In Program Edit Mode, avoid using extreme **Stretch** values.
  - Avoid warping very small audio regions.
  - Warp as few tracks or track regions as possible (i.e., reduce the number of total number of voices of the polyphonic limit that use the Warp algorithm at a given time), especially instances where the warped regions start at the same time.
  - Avoid rapidly triggering samples that are warped.
- If you have warped samples used in a drum program, consider using the **Flatten Pad** function to consolidate the affected pad's layers into one audio sample (see [here](#) to learn about this). After you flatten the pad, its sample/samples no longer need to be warped.

## SATA Drive Installation

To create more internal storage space on your MPC hardware, you can purchase a **SATA** (Serial ATA) drive and install it yourself, but read this chapter first.

Your MPC X, MPC Live, MPC Live II, or MPC Key 61 can support nearly any standard 2.5" SATA drive on the market—either a solid-state drive (SSD) or hard-disk drive (HDD). Make sure it uses a **2.5"** (63.5 mm) form factor and uses (or can use) one of these file systems: **exFAT**, **FAT32**, **NTFS**, or **EXT4** (for read and write capability) or **HFS+** (for read-only capability).

**Note:** We recommend using an exFAT file system as it is the most robust one supported by both Windows and macOS.

**Note:** Alternatively, you could install an **mSATA** (mini-SATA) drive, but make sure you also purchase an adapter that enables it to fit into a typical 2.5" SATA interface.

1. Make sure your MPC hardware is powered **off**.
2. Locate the **SATA drive panel** in the center of the bottom panel of your MPC hardware. Use a Phillips-head screwdriver to remove the screws (don't lose them!), and remove the SATA drive panel.
3. Gently pull the **SATA connector and cable** out from inside your MPC hardware. Be careful not to disturb anything inside—handle just the SATA connector and cable.
4. Connect your **SATA drive** to the **SATA connector**. Make sure the connection is secure.
5. Use four **3x5mm mounting screws** (included with MPC hardware or with your SATA drive) to secure the SATA drive to the SATA drive panel. Do not overtighten the screws, but make sure the drive is secure and does not shake.
6. Place the SATA drive panel back onto the bottom panel of your MPC hardware, and use the original screws to secure it in place.

You can now access this drive while using your MPC hardware!

In Standalone Mode, this drive will appear as a second internal drive.

In Controller Mode, this drive will appear as another drive connected to your computer (just as a USB drive or SD card connected does when connected to your MPC hardware).

## MIDI Machine Control (MMC)

Your MPC hardware can send and receive MIDI Machine Control (MMC) messages, a standard protocol for transport controls.

The MPC hardware can send these messages:

| MPC Button                          | MMC Command Sent  |
|-------------------------------------|---|
| Rec                                 | MMC Record Strobe (when recording starts), then MMC Record Exit |
| Overdub                             | MMC Record Strobe (when recording starts), then MMC Record Exit |
| Stop                                | MMC Stop  |
| Play                                | MMC Deferred Play   |
| Play Start                          | MMC Locate Zero, then Deferred Play                             |
| Data Dial, -/+, Step </>, Bar <</>> | MMC Locate values   |

### To set up your MPC hardware to send MMC messages to an external device:

1. Use a standard 5-pin MIDI cable to connect your MPC hardware's **MIDI Out A** to the MIDI input of your external device.
2. Press **Menu** to show the menu, and tap the **gear icon** to enter the **Preferences**.
3. Tap the **Sync** tab.
4. Tap the **Send Port 1** field, and use the **data dial** or **-/+** buttons to select **Midi Out A**.
5. Tap the **Send MMC** box so it is enabled (checked).
6. Exit the **Preferences**.
7. Configure your other device properly so it can receive MMC messages.

The MPC hardware can receive these messages:

| MPC Command Received                | MPC Function                |
|-------------------------------------|-----------------------------|
| MMC Deferred Play                   | Play                        |
| MMC Locate Zero, then Deferred Play | Play Start                  |
| MMC Stop                            | Stop                        |
| MMC Record Strobe                   | Record (Rec)                |
| MMC Pause                           | Stop                        |
| MMC Locate values                   | Change location in sequence |

### To set up your MPC hardware to receive MMC messages from an external device:

1. Use a standard 5-pin MIDI cable to connect your MPC hardware's **MIDI In A** to the MIDI output of your external device.
2. Press **Menu** to show the menu, and tap the **gear icon** to enter the **Preferences**.
3. Tap the **Sync** tab.
4. Tap the **Receive MMC** box so it is enabled (checked).
5. Exit the **Preferences**.
6. Configure your other device properly so it can send MMC messages.

## Technical Specifications

Specifications are subject to change without notice.

### MPC X / MPC X Special Edition

|  |                                  |   |
|--|----------------------------------|---|
| <b>Digital Audio System</b>                                      | <b>ADCs</b>                      | 24-bit @ 44.1, 48, or 96 kHz  |
|  | <b>DACs</b>                      | 24-bit @ 44.1, 48, or 96 kHz  |
|  | <b>Digital Signal Processing</b> | 32-bit floating point   |
| <b>Mic Inputs 1–2</b><br>(2) balanced XLR+1/4"<br>(6.35 mm) TRS  | <b>Dynamic Range</b>             | 112 dB (A-weighted)   |
|  | <b>SNR</b>                       | 111 dB (1 kHz, +4 dBu, A-weighted)  |
|  | <b>THD+N</b>                     | 0.003% (1 kHz, +4 dBu, -1 dBFS)   |
|  | <b>Preamp EIN</b>                | -135 dBu (max gain, 40 $\Omega$ source, A-weighted)<br>-129.5 dBu (max gain, 150 $\Omega$ source, unweighted) |
|  | <b>Frequency Response</b>        | 20 Hz – 20 kHz (+0.2 / -0.2 dB)   |
|  | <b>Maximum Input Level</b>       | +12.5 dBu   |
|  | <b>Sensitivity</b>               | -46 dBu   |
|  | <b>Gain Range</b>                | 58 dB   |
| <b>Line Inputs 1–2</b><br>(2) balanced XLR+1/4"<br>(6.35 mm) TRS | <b>Dynamic Range</b>             | 114 dB (A-weighted)   |
|  | <b>SNR</b>                       | 112 dB (1 kHz, +4 dBu, A-weighted)  |
|  | <b>THD+N</b>                     | 0.003% (1 kHz, +4 dBu, -1 dBFS)   |
|  | <b>Frequency Response</b>        | 20 Hz – 20 kHz (+0.1 / -0.1 dB)   |
|  | <b>Maximum Input Level</b>       | +20 dBu   |
|  | <b>Sensitivity</b>               | -9.5 dBu  |
|  | <b>Gain Range</b>                | 29.5 dB   |
| <b>Line Inputs 3–4</b><br>(2) balanced 1/4"<br>(6.35 mm) TRS     | <b>Dynamic Range</b>             | 114.5 dB (A-weighted)   |
|  | <b>SNR</b>                       | 112.5 dB (1 kHz, +4 dBu, A-weighted)  |
|  | <b>THD+N</b>                     | 0.003% (1 kHz, +4 dBu, -1 dBFS)   |
|  | <b>Frequency Response</b>        | 20 Hz – 20 kHz (+0.1 / -0.1 dB)   |
|  | <b>Maximum Input Level</b>       | +20 dBu   |
|  | <b>Sensitivity</b>               | -10 dBu   |
|  | <b>Gain Range</b>                | 30 dB   |
| <b>Inst Inputs 1–2</b><br>(2) unbalanced 1/4"<br>(6.35 mm) TS    | <b>Dynamic Range</b>             | 113.5 dB (A-weighted)   |
|  | <b>SNR</b>                       | 111.5 dB (1 kHz, +4 dBu, A-weighted)  |
|  | <b>THD+N</b>                     | 0.003% (1 kHz, +4 dBu, -1 dBFS)   |
|  | <b>Frequency Response</b>        | 20 Hz – 20 kHz (+0.1 / -0.2 dB)   |
|  | <b>Maximum Input Level</b>       | +10 dBu   |
|  | <b>Sensitivity</b>               | -20 dBu   |
|  | <b>Gain Range</b>                | 30 dB   |
|  | <b>Input Impedance</b>           | ~ 1 M $\Omega$  |

|   |                                |  |
|---|--------------------------------|--|
| <b>Phono Inputs</b><br>(2) unbalanced RCA   | <b>Dynamic Range</b>           | 108 dB (A-weighted, 63 mVrms @ 1kHz, -1 dBFS, 20 Ω source)   |
|   | <b>SNR</b>                     | 86 dB (A-weighted, 4 mVrms @ 1kHz, 20 Ω source)  |
|   | <b>THD+N</b>                   | 0.005% (1 kHz, -46 dBu, -1 dBFS)   |
|   | <b>Maximum Input Level</b>     | 63 mVrms (1 kHz)   |
|   | <b>Sensitivity</b>             | 2 mVrms (1 kHz)  |
| <b>Main Outputs 1–2</b><br>(2) impedance-balanced<br>1/4" (6.35 mm) TRS   | <b>Dynamic Range</b>           | 114 dB (A-weighted)  |
|   | <b>THD+N</b>                   | 0.006% (1 kHz, -1 dBFS)  |
|   | <b>Frequency Response</b>      | 20 Hz – 20 kHz (+0.0 / -0.2 dB)  |
|   | <b>Maximum Output Level</b>    | +20 dBu  |
|   | <b>Output Impedance</b>        | 100 Ω  |
| <b>Outputs 3–4</b><br>(2) impedance-balanced<br>1/4" (6.35 mm) TRS  | <b>Dynamic Range</b>           | 114 dB (A-weighted)  |
|   | <b>THD+N</b>                   | 0.006% (1 kHz, -1 dBFS)  |
|   | <b>Frequency Response</b>      | 20 Hz – 20 kHz (+0.0 / -0.2 dB)  |
|   | <b>Maximum Output Level</b>    | +20 dBu  |
|   | <b>Output Impedance</b>        | 100 Ω  |
| <b>Outputs 5–8</b><br>(4) impedance-balanced<br>1/4" (6.35 mm) TRS  | <b>Dynamic Range</b>           | 118.5 dB (A-weighted)  |
|   | <b>THD+N</b>                   | 0.001% (1 kHz, -1 dBFS)  |
|   | <b>Frequency Response</b>      | 20 Hz – 20 kHz (+0.1 / -0.0 dB)  |
|   | <b>Maximum Output Level</b>    | +20 dBu  |
|   | <b>Output Impedance</b>        | 100 Ω  |
| <b>Headphone Outputs</b><br>(1) 1/4" (6.35 mm)<br>stereo headphone<br><br>(1) 1/8" (3.5 mm)<br>stereo headphone | <b>Dynamic Range</b>           | 111 dB (A-weighted)  |
|   | <b>THD+N</b>                   | 0.007% (1 kHz, -1 dBFS, 10 mW/channel into 32 Ω headphones)  |
|   | <b>Frequency Response</b>      | 20 Hz – 20 kHz (+0.0 / -0.2 dB)  |
|   | <b>Maximum Power Delivered</b> | 360 mW (<1% THD)   |
|   | <b>Maximum Output Level</b>    | +20 dBu  |
| <b>Mechanical</b>   | <b>Pads</b>                    | (16) velocity- and pressure-sensitive pads, RGB-backlit<br>(8) banks accessible via Pad Bank buttons   |
|   | <b>Knobs</b>                   | (16) 360° touch-sensitive Q-Link knobs for parameter adjustment<br>(7) 270° knobs for gain, mix & level adjustment<br>(1) 360° encoder for value/data adjustment |
|   | <b>Display</b>                 | 10.1" (25.6 cm) full-color 1280x800 display with capacitive multi-touch  |

|   |  |  |
|---|--|--|
| <b>Memory</b>                                 | <b>RAM</b>   | 2 GB (MPC X)<br>4 GB (MPC X Special Edition)   |
|   | <b>Internal Storage</b>  | 16 GB (MPC X) (6 GB user storage)<br>48 GB (MPC X Special Edition) (10 GB user storage)<br>Expandable via SATA connections |
| <b>File System Compatibility</b>              | exFAT (read & write) (recommended)<br>FAT32 (read & write)<br>NTFS (read & write)<br>EXT4 (read & write)<br>HFS+ (read only)<br>Audio Files: AIF/AIFF, FLAC, MP3, OGG, WAV   |  |
| <b>Wi-Fi</b>                                  | <b>Frequency</b>   | 2.4 GHz / 5 GHz  |
|   | <b>Standard</b>  | 802.11a/b/g/n/ac   |
|   | <b>Max. Power</b>  | 2.4 GHz Wi-Fi: +17 dBm<br>5 GHz Wi-Fi: +17 dBm   |
| <b>Bluetooth</b>                              | <b>Version</b>   | 4.0, 4.2, 5 (MPC X)<br>5 (MPC X Special Edition)   |
|   | <b>Profile</b>   | HID, A2DP  |
| <b>Connections</b>                            | <p>(2) XLR+1/4" (6.35 mm) TRS inputs (Input 1/2)</p> <p>(2) 1/4" (6.35 mm) TRS inputs (Input 3/4: 1 stereo pair)</p> <p>(2) 1/4" (6.35 mm) TS instrument inputs (Inst 1/2)</p> <p>(2) RCA inputs (Input 3/4: 1 stereo pair, phono- or line-level)</p> <p>(2) 1/4" (6.35 mm) TS footswitch inputs (FS 1/2)</p> <p>(2) 5-pin MIDI inputs</p> <p>(8) 1/4" (6.35 mm) TRS outputs (Main L/R, Outputs 3/4–7/8: 4 stereo pairs)</p> <p>(4) 5-pin MIDI outputs</p> <p>(8) 1/8" (3.5 mm) CV/Gate outputs</p> <p>(1) 1/4" (6.35 mm) stereo headphone output</p> <p>(1) 1/8" (3.5 mm) stereo headphone output</p> <p>(2) USB Type-A ports</p> <p>(1) USB Type-B port</p> <p>(1) SD card slot</p> <p>(1) power adapter input</p> |  |
| <b>Power</b>                                  | via power adapter: 19 V, 3.42 A, center-positive, included   |  |
| <b>Dimensions</b><br>(width x depth x height) | 19.9" x 16.7" x 3.4" / 50.5 x 42.4 x 8.7 cm (display flat)<br>19.9" x 15.3" x 8.4" / 50.5 x 38.8 x 21.4 cm (display upright)   |  |
| <b>Weight</b>                                 | 12.57 lb.  |  |
|   | 5.66 kg  |  |



## MPC Live

|   |                                  |   |
|---|----------------------------------|---|
| <b>Digital Audio System</b>   | <b>ADCs</b>                      | 24-bit @ 44.1, 48, or 96 kHz                                |
|   | <b>DACs</b>                      | 24-bit @ 44.1, 48, or 96 kHz                                |
|   | <b>Digital Signal Processing</b> | 32-bit floating point                                       |
| <b>Line Inputs</b><br>(2) balanced<br>1/4" (6.35 mm) TRS                | <b>Dynamic Range</b>             | 113.5 dB (A-weighted)                                       |
|   | <b>SNR</b>                       | 108 dB (1 kHz, +4 dBu, A-weighted)                          |
|   | <b>THD+N</b>                     | 0.001% (1 kHz, +4 dBu, -1 dBFS)                             |
|   | <b>Frequency Response</b>        | 20 Hz – 20 kHz (+0.0 / -0.1 dB)                             |
|   | <b>Maximum Input Level</b>       | +11 dBu   |
|   | <b>Sensitivity</b>               | -13.5 dBu   |
|   | <b>Gain Range</b>                | 24.5 dB   |
| <b>Phono Inputs</b><br>(2) unbalanced RCA                               | <b>Dynamic Range</b>             | 107 dB (A-weighted, 63 mVrms @ 1 kHz, -1 dBFS, 20 Ω source) |
|   | <b>SNR</b>                       | 86 dB (A-weighted, 4 mVrms @ 1 kHz, 20 Ω source)            |
|   | <b>THD+N</b>                     | 0.009% (1 kHz, -46 dBu, -1 dBFS)                            |
|   | <b>Maximum Input Level</b>       | 63 mVrms (1 kHz)  |
|   | <b>Sensitivity</b>               | 2 mVrms (1 kHz)   |
| <b>Main Outputs 1–2</b><br>(2) impedance-balanced<br>1/4" (6.35 mm) TRS | <b>Dynamic Range</b>             | 113 dB (A-weighted)   |
|   | <b>THD+N</b>                     | 0.002% (1 kHz, -1 dBFS)                                     |
|   | <b>Frequency Response</b>        | 20 Hz – 20 kHz (+0.0 / -0.5 dB)                             |
|   | <b>Maximum Output Level</b>      | +9 dBu  |
|   | <b>Output Impedance</b>          | 100 Ω   |
| <b>Outputs 3–6</b><br>(4) impedance-balanced<br>1/4" (6.35 mm) TRS      | <b>Dynamic Range</b>             | 116 dB (A-weighted)   |
|   | <b>THD+N</b>                     | 0.001% (1 kHz, -1 dBFS)                                     |
|   | <b>Frequency Response</b>        | 20 Hz – 20 kHz (+0.0 / -0.1 dB)                             |
|   | <b>Maximum Output Level</b>      | +9 dBu  |
|   | <b>Output Impedance</b>          | 100 Ω   |
| <b>Headphone Output</b><br>(1) 1/8" (3.5 mm)<br>stereo headphone        | <b>Dynamic Range</b>             | 112 dB (A-weighted)   |
|   | <b>THD+N</b>                     | 0.005% (1 kHz, -1 dBFS, 10 mW/channel into 32 Ω headphones) |
|   | <b>Frequency Response</b>        | 20 Hz – 20 kHz (+0.0 / -0.2 dB)                             |
|   | <b>Maximum Power Delivered</b>   | +35 mW (<1% THD, 32 Ω headphones)                           |
|   | <b>Maximum Output Level</b>      | +10 dBu   |

|   |  |  |
|---|--|--|
| <b>Mechanical</b>                             | <b>Pads</b>  | (16) velocity- and pressure-sensitive pads, RGB-backlit<br>(8) banks accessible via Pad Bank buttons   |
|   | <b>Knobs</b>   | (4) 360° touch-sensitive Q-Link knobs<br>(4) Q-Link knob columns accessible via Q-Link button<br>(1) 360° encoder for value/data adjustment and selection via push |
|   | <b>Display</b>   | 7" (17.8 cm) full-color 1280x800 display with capacitive multi-touch   |
| <b>Memory</b>                                 | <b>RAM</b>   | 2 GB   |
|   | <b>Internal Storage</b>  | 16 GB (6 GB user storage + 10 GB pre-installed content)<br>Expandable via SATA connections   |
| <b>File System Compatibility</b>              | exFAT (read & write) (recommended)<br>FAT32 (read & write)<br>NTFS (read & write)<br>EXT4 (read & write)<br>HFS+ (read only)<br>Audio Files: AIF/AIFF, FLAC, MP3, OGG, WAV   |  |
| <b>Wi-Fi</b>                                  | <b>Frequency</b>   | 2.4 GHz / 5 GHz  |
|   | <b>Standard</b>  | 802.11a/b/g/n/ac   |
|   | <b>Max. Power</b>  | 2.4 GHz Wi-Fi: +17 dBm<br>5 GHz Wi-Fi: +17 dBm   |
| <b>Bluetooth</b>                              | <b>Version</b>   | 4.0, 4.2   |
|   | <b>Profile</b>   | HID, A2DP  |
| <b>Connections</b>                            | (2) 1/4" (6.35 mm) TRS inputs (1 stereo pair)<br>(6) 1/4" (6.35 mm) TRS outputs (3 stereo pairs)<br>(1) 1/8" (3.5 mm) stereo headphone output<br>(2) RCA inputs (1 stereo pair)<br>(2) 5-pin MIDI inputs<br>(2) 5-pin MIDI outputs<br>(2) USB Type-A ports<br>(1) USB Type-B port<br>(1) SD card slot<br>(1) power adapter input |  |
| <b>Power</b>                                  | via power adapter: 19 V, 3.42 A, center-positive, included<br>via battery: lithium-ion, rechargeable, up to 6 hours of battery life  |  |
| <b>Dimensions</b><br>(width x depth x height) | 16.7" x 8.8" x 2.7"<br>42.4 x 22.4 x 6.9 cm  |  |
| <b>Weight</b>                                 | 5.9 lb.  |  |
|   | 2.7 kg   |  |

## MPC Live II

|   |                                  |   |
|---|----------------------------------|---|
| <b>Digital Audio System</b>   | <b>ADCs</b>                      | 24-bit @ 44.1, 48, or 96 kHz                                  |
|   | <b>DACs</b>                      | 24-bit @ 44.1, 48, or 96 kHz                                  |
|   | <b>Digital Signal Processing</b> | 32-bit floating point   |
| <b>Line Inputs</b><br>(2) balanced<br>1/4" (6.35 mm) TRS                | <b>Dynamic Range</b>             | 113 dB (A-weighted)   |
|   | <b>SNR</b>                       | 108.5 dB (1 kHz, +4 dBu, A-weighted)                          |
|   | <b>THD+N</b>                     | 0.001% (1 kHz, +4 dBu, -1 dBFS)                               |
|   | <b>Frequency Response</b>        | 20 Hz – 20 kHz (+0.0 / -0.1 dB)                               |
|   | <b>Maximum Input Level</b>       | +16.5 dBu   |
|   | <b>Sensitivity</b>               | -13 dBu   |
|   | <b>Gain Range</b>                | 29.5 dB   |
| <b>Phono Inputs</b><br>(2) unbalanced RCA                               | <b>Dynamic Range</b>             | 108.5 dB (A-weighted, 74 mVrms @ 1 kHz, -1 dBFS, 20 Ω source) |
|   | <b>SNR</b>                       | 87 dB (A-weighted, 4 mVrms @ 1 kHz, 20 Ω source)              |
|   | <b>THD+N</b>                     | 0.011% (1 kHz, -46 dBu, -1 dBFS)                              |
|   | <b>Maximum Input Level</b>       | 74 mVrms (1 kHz)  |
|   | <b>Sensitivity</b>               | 2 mVrms (1 kHz)   |
| <b>Main Outputs 1–2</b><br>(2) impedance-balanced<br>1/4" (6.35 mm) TRS | <b>Dynamic Range</b>             | 118 dB (A-weighted)   |
|   | <b>THD+N</b>                     | 0.001% (1 kHz, -1 dBFS)                                       |
|   | <b>Frequency Response</b>        | 20 Hz – 20 kHz (+0.0 / -0.2 dB)                               |
|   | <b>Maximum Output Level</b>      | +9 dBu  |
|   | <b>Output Impedance</b>          | 100 Ω   |
| <b>Outputs 3–4</b><br>(2) impedance-balanced<br>1/4" (6.35 mm) TRS      | <b>Dynamic Range</b>             | 116.5 dB (A-weighted)   |
|   | <b>THD+N</b>                     | 0.001% (1 kHz, -1 dBFS)                                       |
|   | <b>Frequency Response</b>        | 20 Hz – 20 kHz (+0.0 / -0.1 dB)                               |
|   | <b>Maximum Output Level</b>      | +9 dBu  |
|   | <b>Output Impedance</b>          | 100 Ω   |
| <b>Outputs 5–6</b><br>(2) impedance-balanced<br>1/4" (6.35 mm) TRS      | <b>Dynamic Range</b>             | 112.5 dB (A-weighted)   |
|   | <b>THD+N</b>                     | 0.002% (1 kHz, -1 dBFS)                                       |
|   | <b>Frequency Response</b>        | 20 Hz – 20 kHz (+0.0 / -0.1 dB)                               |
|   | <b>Maximum Output Level</b>      | +9 dBu  |
|   | <b>Output Impedance</b>          | 100 Ω   |

|   |   |   |
|---|---|---|
| <b>Headphone Output</b><br>(1) 1/8" (3.5 mm) stereo headphone | <b>Dynamic Range</b>  | 111 dB (A-weighted)   |
|   | <b>THD+N</b>  | 0.003% (1 kHz, -1 dBFS, 10 mW/channel into 32 Ω headphones) |
|   | <b>Frequency Response</b>   | 20 Hz – 20 kHz (+0.0 / -0.2 dB)                             |
|   | <b>Maximum Power Delivered</b>  | +35 mW (<1% THD, 32 Ω headphones)                           |
|   | <b>Maximum Output Level</b>   | +10 dBu   |
|   | <b>Output Impedance</b>   | 32 Ω  |
| <b>Pads</b>   | (16) velocity- and pressure-sensitive pads, RGB-backlit<br>(8) banks accessible via Pad Bank buttons  |   |
| <b>Knobs</b>  | (4) 360° touch-sensitive Q-Link Knobs<br>(4) Q-Link Knob columns accessible via Q-Link button<br>(1) 360° encoder for display navigation and selection via push   |   |
| <b>Buttons</b>  | (27) dedicated function buttons; red-, amber-, or green-backlit   |   |
| <b>Display</b>  | 6.9" / 176 mm (diagonal)<br>5.9" x 3.7" / 150 x 93 mm (width x height)<br>Full-color LED-backlit display with touch interface   |   |
| <b>CPU</b>  | <b>Processor:</b> Quad-core ARM® processor<br><b>RAM:</b> 2 GB<br><b>Storage:</b> 16 GB, expandable via SATA connections  |   |
| <b>Wi-Fi</b>  | <b>Frequency</b>  | 2.4 GHz / 5 GHz   |
|   | <b>Standard</b>   | 802.11a/b/g/n/ac  |
|   | <b>Max. Power</b>   | 2.4 GHz Wi-Fi: +17 dBm<br>5 GHz Wi-Fi: +17 dBm              |
| <b>Bluetooth</b>  | <b>Version</b>  | 4.2, 5  |
|   | <b>Profile</b>  | HID, A2DP   |
| <b>Connections</b>  | (2) 1/4" (6.35 mm) TRS inputs (1 stereo pair)<br>(6) 1/4" (6.35 mm) TRS outputs (3 stereo pairs)<br>(1) 1/4" (6.35 mm) stereo headphone output<br>(2) RCA inputs (1 stereo pair)<br>(2) 5-pin MIDI inputs<br>(2) 5-pin MIDI outputs<br>(4) Stereo CV/Gate outputs<br>(1) Ethernet link port<br>(2) USB Type-A ports<br>(1) USB Type-B port<br>(1) SD card slot<br>(1) power adapter input |   |

|   |   |
|---|---|
| <b>Power</b>                                  | <b>via power adapter:</b> 19 V, 3.42 A, center-positive, included<br><b>via battery:</b> lithium-ion, rechargeable, up to 4 hours of battery life |
| <b>Dimensions</b><br>(width x depth x height) | 16.2" x 9.6" x 1.8"<br>411.5 x 243.8 x 45.7 mm  |
| <b>Weight</b>                                 | 7.45 lbs.<br>3.38 kg  |

## MPC One / MPC One+

|  |   |   |
|--|---|---|
| <b>Digital Audio System</b>                                      | <b>ADCs</b>   | 24-bit @ 44.1, 48, or 96 kHz  |
|  | <b>DACs</b>   | 24-bit @ 44.1, 48, or 96 kHz  |
|  | <b>Digital Signal Processing</b>  | 32-bit floating point   |
| <b>Line Inputs 1–2</b><br>(2) balanced 1/4"<br>(6.35 mm) TRS     | <b>Frequency Response</b>   | 20 Hz – 20 kHz (+0/-0.8 dB)   |
|  | <b>Dynamic Range</b>  | 113 dB (A-weighted)   |
|  | <b>Signal-to-Noise Ratio</b>  | 111 dB (1 kHz, +4 dBu, A-weighted)  |
|  | <b>THD+N</b>  | 0.002% (1 kHz, +4 dBu, -1 dBFS)   |
|  | <b>Max Input Level</b>  | +16 dBu   |
|  | <b>Sensitivity</b>  | -13.5 dBu   |
|  | <b>Gain Range</b>   | 29.5 dB   |
| <b>Line Outputs 1–2</b><br>(2) balanced 1/4"<br>(6.35 mm) TRS    | <b>Frequency Response</b>   | 20 Hz – 20 kHz (+0/-0.8 dB)   |
|  | <b>Dynamic Range</b>  | 113 dB (A-weighted)   |
|  | <b>THD+N</b>  | 0.003% (1 kHz, -1 dBFS)   |
|  | <b>Maximum Output Level</b>   | +9 dBu  |
|  | <b>Output Impedance</b>   | 100 Ω   |
| <b>Headphone Output</b><br>(1) 1/8" (3.5 mm)<br>stereo headphone | <b>Frequency Response</b>   | 20 Hz – 20 kHz (+0/-0.8 dB)   |
|  | <b>Dynamic Range</b>  | 112.5 dB (A-weighted, 32Ω)  |
|  | <b>THD+N</b>  | 0.006% (1 kHz, -1 dBFS, 32Ω)  |
|  | <b>Maximum Output Level</b>   | 28.8 mW @ 32Ω   |
| <b>Mechanical</b>  | <b>Pads</b>   | (16) velocity- and pressure-sensitive pads, RGB-backlit<br>(8) banks accessible via Pad Bank buttons  |
|  | <b>Knobs</b>  | (4) 360° touch-sensitive Q-Link Knobs<br>(4) Q-Link Knob columns accessible via Q-Link button<br>(1) 360° encoder for display navigation and selection via push |
|  | <b>Buttons</b>  | (31) dedicated function buttons; red-, amber-, or green-backlit   |
|  | <b>Display</b>  | 7.0" / 177 mm (diagonal)<br>5.9" x 3.7" / 151 x 94 mm (width x height)<br>Full-color LED-backlit display with touch interface                                   |
| <b>CPU</b>   | <b>Processor:</b> Quad-core ARM® processor<br><b>RAM:</b> 2 GB<br><b>Storage:</b> 2 GB user storage, 2 GB pre-installed content (MPC One)<br>16 GB internal storage, 7.8 GB user storage (MPC One+) |   |

|   |  |
|---|--|
| <b>File System Compatibility</b>              | <p>exFAT (read &amp; write) (recommended)</p> <p>FAT32 (read &amp; write)</p> <p>NTFS (read &amp; write)</p> <p>EXT4 (read &amp; write)</p> <p>HFS+ (read only)</p> <p>Audio Files: AIF/AIFF, FLAC, MP3, OGG, WAV</p>  |
| <b>Wi-Fi</b>                                  | <p><b>Frequency</b> 2.4 GHz / 5 GHz</p>  |
|   | <p><b>Standard</b> 802.11a/b/g/n/ac</p>  |
|   | <p><b>Max. Power</b> 2.4 GHz Wi-Fi: +17 dBm<br/>5 GHz Wi-Fi: +17 dBm</p>   |
| <b>Bluetooth</b>                              | <p><b>Version</b> 4.2, 5 (MPC One)<br/>5 (MPC One+)</p>  |
|   | <p><b>Profile</b> HID, A2DP</p>  |
| <b>Connections</b>                            | <p>(2) 1/4" (6.35 mm) TRS inputs (1 stereo pair)</p> <p>(2) 1/4" (6.35 mm) TRS outputs (1 stereo pair)</p> <p>(1) 1/8" (3.5 mm) stereo headphone output</p> <p>(1) 5-pin MIDI inputs</p> <p>(1) 5-pin MIDI outputs</p> <p>(4) CV/Gate outputs</p> <p>(1) USB Type-A port</p> <p>(1) USB Type-B port</p> <p>(1) SD card slot</p> <p>(1) power adapter input</p> |
| <b>Power</b>                                  | <p>via included power adapter:</p> <p><b>MPC One:</b> 19 V, 3.42 A, center-positive</p> <p><b>MPC One+:</b> 12 V, 3 A, center-positive</p>   |
| <b>Dimensions</b><br>(width x depth x height) | <p>10.7" x 10.7" x 2.1"</p> <p>272 x 272 x 53 mm</p>   |
| <b>Weight</b>                                 | <p>4.7 lbs.</p> <p>2.1 kg</p>  |

## MPC Key 61

|   |                                  |   |
|---|----------------------------------|---|
| <b>Digital Audio System</b>   | <b>ADCs</b>                      | 24-bit @ 44.1, 48, or 96 kHz  |
|   | <b>DACs</b>                      | 24-bit @ 44.1, 48, or 96 kHz  |
|   | <b>Digital Signal Processing</b> | 32-bit floating point   |
| <b>Mic Inputs 1–2</b><br>(2) balanced XLR+1/4"<br>(6.35 mm) TRS         | <b>Frequency Response</b>        | 20 Hz – 20 kHz (+0.2 / -1.0 dB)   |
|   | <b>Dynamic Range</b>             | 111 dB (A-weighted)   |
|   | <b>SNR</b>                       | 110 dB (1 kHz, +4 dBu, A-weighted)  |
|   | <b>THD+N</b>                     | 0.002% (1 kHz, +4 dBu, -1 dBFS)   |
|   | <b>Preamp EIN</b>                | -130 dBu (max gain, 40 Ω source, A-weighted)<br>-128 dBu (max gain, 150 Ω source, unweighted) |
|   | <b>Maximum Input Level</b>       | +13 dBu   |
|   | <b>Sensitivity</b>               | -46 dBu   |
|   | <b>Gain Range</b>                | 59 dB   |
| <b>Line Inputs 1–2</b><br>(2) balanced XLR+1/4"<br>(6.35 mm) TRS        | <b>Frequency Response</b>        | 20 Hz – 20 kHz (+0.2 / -1.0 dB)   |
|   | <b>Dynamic Range</b>             | 112 dB (A-weighted)   |
|   | <b>SNR</b>                       | 111 dB (1 kHz, +4 dBu, A-weighted)  |
|   | <b>THD+N</b>                     | 0.001% (1 kHz, +4 dBu, -1 dBFS)   |
|   | <b>Maximum Input Level</b>       | +20 dBu   |
|   | <b>Sensitivity</b>               | -11 dBu   |
|   | <b>Gain Range</b>                | 31 dB   |
| <b>Inst Inputs 1–2</b><br>(2) unbalanced 1/4"<br>(6.35 mm) TS           | <b>Frequency Response</b>        | 20 Hz – 20 kHz (+0.2 / -1.0 dB)   |
|   | <b>Dynamic Range</b>             | 112 dB (A-weighted)   |
|   | <b>SNR</b>                       | 106 dB (1 kHz, +4 dBu, A-weighted)  |
|   | <b>THD+N</b>                     | 0.001% (1 kHz, +4 dBu, -1 dBFS)   |
|   | <b>Maximum Input Level</b>       | +16 dBu   |
|   | <b>Sensitivity</b>               | -15 dBu   |
|   | <b>Gain Range</b>                | 31 dB   |
|   | <b>Input Impedance</b>           | 1 MΩ  |
| <b>Main Outputs 1–2</b><br>(2) impedance-balanced<br>1/4" (6.35 mm) TRS | <b>Frequency Response</b>        | 20 Hz – 20 kHz (+0.03 / -0.2 dB)  |
|   | <b>Dynamic Range</b>             | 115 dB (A-weighted)   |
|   | <b>THD+N</b>                     | 0.004% (1 kHz, -1 dBFS)   |
|   | <b>Maximum Output Level</b>      | +16 dBu   |
|   | <b>Output Impedance</b>          | 50 Ω  |



|   |  |   |
|---|--|---|
| <b>Outputs 3–4</b><br>(2) impedance-balanced 1/4" (6.35 mm) TRS | <b>Frequency Response</b>  | 20 Hz – 20 kHz (+0.03 / -0.2 dB)  |
|   | <b>Dynamic Range</b>   | 115 dB (A-weighted)   |
|   | <b>THD+N</b>   | 0.004% (1 kHz, -1 dBFS)   |
|   | <b>Maximum Output Level</b>  | +16 dBu   |
|   | <b>Output Impedance</b>  | 50 Ω  |
| <b>Headphone Output</b><br>(1) 1/4" (6.35 mm) stereo headphone  | <b>Frequency Response</b>  | 20 Hz – 20 kHz (+0.05 / -0.2 dB)  |
|   | <b>Dynamic Range</b>   | 108 dB (A-weighted)   |
|   | <b>THD+N</b>   | 0.004% (1 kHz, 10 mW per channel into 32 Ω headphones)  |
|   | <b>Maximum Output Level</b>  | +6 dBu (unloaded)   |
|   | <b>Power Output</b>  | 40 mW RMS (per channel into 32 Ω headphones)  |
| <b>Mechanical</b>   | <b>Keys</b>  | 61 semi-weighted keys with aftertouch   |
|   | <b>Pads</b>  | (16) velocity- and pressure-sensitive pads, RGB-backlit<br>(8) banks accessible via Pad Bank buttons  |
|   | <b>Knobs</b>   | (4) 360° touch-sensitive Q-Link knobs<br>(4) Q-Link Knob columns accessible via Q-Link button<br>(1) 360° encoder for value/data adjustment |
|   | <b>Buttons</b>   | (44) dedicated function buttons; white-, red-, or green-backlit   |
|   | <b>Touch Strip</b>   | (1) Multi-function, touch-capacitive control strip<br>0.8" x 4.4" / 20 x 113 mm (width x height)  |
|   | <b>Display</b>   | 7" / 177 mm (diagonal)<br>Full-color LED-backlit display with touch interface   |
|   | <b>Memory</b>  | <b>RAM</b>  |
| <b>Internal Storage</b>   |  | 32 GB<br>Expandable via SATA connections  |
| <b>File System Compatibility</b>                                | exFAT (read & write) (recommended)<br>FAT32 (read & write)<br>NTFS (read & write)<br>EXT4 (read & write)<br>HFS+ (read only)<br>Audio Files: AIF/AIFF, FLAC, MP3, OGG, WAV |   |

|   |   |  |
|---|---|--|
| <b>Wi-Fi</b>                                  | <b>Frequency</b>  | 2.4 GHz / 5 GHz                                |
|   | <b>Standard</b>   | 802.11a/b/g/n/ac                               |
|   | <b>Max. Power</b>   | 2.4 GHz Wi-Fi: +17 dBm<br>5 GHz Wi-Fi: +17 dBm |
| <b>Bluetooth</b>                              | <b>Version</b>  | 5  |
|   | <b>Profile</b>  | HID, A2DP                                      |
| <b>Connections</b>                            | <p>(2) 1/4" (6.35 mm) Combo XLR/TRS inputs (1 stereo pair)</p> <p>(1) 1/4" (6.35 mm) TRS sustain pedal input (TS compatible)</p> <p>(1) 1/4" (6.35 mm) TRS footswitch pedal input (TS compatible)</p> <p>(1) 1/4" (6.35 mm) TRS expression pedal input (TS compatible)</p> <p>(4) 1/4" (6.35 mm) TRS outputs (2 stereo pairs)</p> <p>(1) 1/4" (6.35 mm) stereo headphone output</p> <p>(8) 1/8" (3.5 mm) TS mono CV/Gate outputs</p> <p>(1) 5-pin MIDI input</p> <p>(1) 5-pin MIDI output</p> <p>(1) 5-pin MIDI thru-port</p> <p>(1) Ethernet link port</p> <p>(2) USB Type-A ports</p> <p>(1) USB Type-B port</p> <p>(1) IEC power input</p> |  |
| <b>Power</b>                                  | 100 V – 240 V AC, 50/60 Hz, 65 W  |  |
| <b>Dimensions</b><br>(width x depth x height) | 38.8" x 12.3" x 3.8"<br>986 x 313 x 96.7 mm   |  |
| <b>Weight</b>                                 | 17.9 lbs.<br>8.1 kg   |  |

## MPC Key 37

|   |                                  |   |
|---|----------------------------------|---|
| <b>Digital Audio System</b>   | <b>ADCs</b>                      | 24-bit @ 44.1, 48, or 96 kHz  |
|   | <b>DACs</b>                      | 24-bit @ 44.1, 48, or 96 kHz  |
|   | <b>Digital Signal Processing</b> | 32-bit floating point   |
| <b>Line Inputs 1–2</b><br>(2) balanced 1/4" (6.35 mm) TRS or unbalanced 1/4" (6.35 mm) TS | <b>Frequency Response</b>        | 20 Hz – 20 kHz (+0.2/-0.5 dB)   |
|   | <b>Signal-to-Noise Ratio</b>     | 107 dB (1 kHz, +6 dBV, A-weighted)  |
|   | <b>THD+N</b>                     | 0.004% (1 kHz, +6 dBV, 0 dBFS)  |
|   | <b>Max Input Level</b>           | +12 dBV   |
|   | <b>Sensitivity</b>               | -10 dBV   |
|   | <b>Gain Range</b>                | 27 dB   |
| <b>Line Outputs 1–2</b><br>(2) impedance-balanced 1/4" (6.35 mm) TRS                      | <b>Frequency Response</b>        | 20 Hz – 20 kHz (+0.2/-0.5 dB)   |
|   | <b>Dynamic Range</b>             | 112 dB (A-weighted)   |
|   | <b>THD+N</b>                     | 0.004% (1 kHz, 0 dBFS)  |
|   | <b>Maximum Output Level</b>      | +6 dBV  |
|   | <b>Output Impedance</b>          | 100 $\Omega$  |
| <b>Headphone Output</b><br>(1) 1/8" (3.5 mm) stereo headphone                             | <b>Frequency Response</b>        | 20 Hz – 20 kHz (+0.2/-0.5 dB)   |
|   | <b>Dynamic Range</b>             | 112 dB (A-weighted)   |
|   | <b>THD+N</b>                     | 0.006% (1 kHz, 10mW per channel into 32 $\Omega$ )  |
|   | <b>Maximum Output Level</b>      | 40 mW RMS (per channel into 32 $\Omega$ )   |
| <b>Mechanical</b>   | <b>Keys</b>                      | 37 synth-action keys with aftertouch  |
|   | <b>Pads</b>                      | (16) velocity- and pressure-sensitive pads, RGB-backlit<br>(8) banks accessible via Pad Bank buttons  |
|   | <b>Knobs</b>                     | (4) 360° touch-sensitive Q-Link knobs<br>(4) Q-Link Knob columns accessible via Q-Link button<br>(1) 360° encoder for value/data adjustment |
|   | <b>Buttons</b>                   | (38) dedicated function buttons; white-, red-, or green-backlit   |
|   | <b>Display</b>                   | 7" / 177 mm (diagonal)<br>Full-color LED-backlit display with touch interface   |
| <b>Memory</b>   | <b>RAM</b>                       | 2 GB  |
|   | <b>Internal Storage</b>          | 32 GB   |

|   |   |
|---|---|
| <b>File System Compatibility</b>              | exFAT (read & write) (recommended)<br>FAT32 (read & write)<br>NTFS (read & write)<br>EXT4 (read & write)<br>HFS+ (read only)<br>Audio Files: AIF/AIFF, FLAC, MP3, OGG, WAV  |
| <b>Wi-Fi</b>                                  | <b>Frequency</b> 2.4 GHz / 5 GHz  |
|   | <b>Standard</b> 802.11a/b/g/n/ac  |
|   | <b>Max. Power</b> 2.4 GHz Wi-Fi: +17 dBm<br>5 GHz Wi-Fi: +17 dBm  |
| <b>Bluetooth</b>                              | <b>Version</b> 5  |
|   | <b>Profile</b> HID, A2DP  |
|   | <b>Max. Power</b> +10 dBm   |
| <b>Connections</b>                            | (2) 1/4" (6.35 mm) TRS inputs (1 stereo pair)<br>(1) 1/4" (6.35 mm) TRS sustain pedal input (TS compatible)<br>(1) 1/4" (6.35 mm) TRS footswitch pedal input (TS compatible)<br>(1) 1/4" (6.35 mm) TRS expression pedal input (TS compatible)<br>(2) 1/4" (6.35 mm) TRS outputs (1 stereo pair)<br>(1) 1/4" (6.35 mm) stereo headphone output<br>(4) 1/8" (3.5 mm) TRS stereo CV/Gate outputs<br>(1) USB Type-A port<br>(1) USB Type-B port<br>(1) 5-pin MIDI input<br>(1) 5-pin MIDI output<br>(1) Power adapter input |
| <b>Power</b>                                  | via included 12 V, 3 A, center-positive power adapter   |
| <b>Dimensions</b><br>(width x depth x height) | 22.92" x 12.36" x 4.08"<br>58.22 x 31.39 x 10.36 cm   |
| <b>Weight</b>                                 | 8.82 lbs.<br>4 kg   |

**MPC Studio mk2**

|   |  |
|---|--|
| <b>Pads</b>                                   | (16) velocity- and pressure-sensitive pads, RGB-backlit<br>(8) banks accessible via Pad Bank buttons |
| <b>Knobs</b>                                  | (1) 360° push encoder for display navigation and selection   |
| <b>Touch Strip</b>                            | (1) multi-function 5.5" (140 mm) touch-capacitive controller with LED indicators                     |
| <b>Buttons</b>                                | (39) LED backlit dedicated function buttons  |
| <b>Display</b>                                | Full-color LCD   |
| <b>Connections</b>                            | (1) 1/8" (3.5 mm) MIDI input<br>(1) 1/8" (3.5 mm) MIDI output<br>(1) USB Type-B port                 |
| <b>Power</b>                                  | via USB  |
| <b>Dimensions</b><br>(width x depth x height) | 12.0" x 6.7" x 1.5"<br>305 x 171 x 37 mm   |
| <b>Weight</b>                                 | 1.8 lbs.<br>0.83 kg  |

## MPC Touch

|   |   |  |
|---|---|--|
| <b>Line Inputs</b><br>(2) balanced<br>1/4" (6.35 mm) TRS            | <b>Dynamic Range</b>  | 102 dB (A-weighted)  |
|   | <b>SNR</b>  | 99 dB (1 kHz, +4 dBu, A-weighted)  |
|   | <b>THD+N</b>  | 0.002% (1 kHz, +4 dBu, -1 dBFS)  |
|   | <b>Frequency Response</b>   | 20 Hz – 20 kHz (+0.1 / -0.1 dB)  |
|   | <b>Maximum Input Level</b>  | +15 dBu  |
|   | <b>Input Impedance</b>  | 12 K $\Omega$ (balanced), 5 K $\Omega$ (unbalanced)  |
|   | <b>Sensitivity</b>  | -16 dBu  |
|   | <b>Gain Range</b>   | 31 dB  |
| <b>Main Outputs</b><br>(2) impedance-balanced 1/4"<br>(6.35 mm) TRS | <b>Dynamic Range</b>  | 100 dB (A-weighted)  |
|   | <b>THD+N</b>  | 0.006% (1 kHz, -1 dBFS)  |
|   | <b>Frequency Response</b>   | 20 Hz – 20 kHz (+0.25 / -0.25 dB)  |
|   | <b>Maximum Output Level</b>   | +8 dBu   |
|   | <b>Output Impedance</b>   | 100 $\Omega$   |
| <b>Headphone Output</b><br>(1) 1/8" (3.5 mm)<br>stereo headphone    | <b>THD+N</b>  | 0.009% (1 kHz, -1 dBFS, 10 mW/channel into 32 $\Omega$ headphones)   |
|   | <b>Frequency Response</b>   | 20 Hz – 20 kHz (+0.3 / -0.3 dB)  |
|   | <b>Maximum Output Level</b>   | +6 dBu   |
|   | <b>Maximum Power Delivered</b>  | 12 mW/channel  |
|   | <b>Output Impedance</b>   | 33 $\Omega$  |
| <b>Mechanical</b>   | <b>Pads</b>   | (16) velocity- and pressure-sensitive pads, RGB-backlit<br>(8) banks accessible via Pad Bank buttons   |
|   | <b>Knobs</b>  | (4) 360° touch-sensitive Q-Link knobs<br>(4) Q-Link knob columns accessible via Q-Link button<br>(1) 360° encoder for value/data adjustment and selection via push |
|   | <b>Display</b>  | 7.0" (17.8 cm) full-color 1280x800 display with capacitive multi-touch   |
| <b>Connections</b>  | (2) 1/4" (6.35 mm) TRS inputs (1 stereo pair)<br>(2) 1/4" (6.35 mm) TRS outputs (1 stereo pair)<br>(1) 1/8" (3.5 mm) stereo headphone output<br>(1) 1/8" (3.5 mm) MIDI input (1/8"-to-5-pin adapter included)<br>(1) 1/8" (3.5 mm) MIDI output (1/8"-to-5-pin adapter included)<br>(1) USB Type-B port<br>(1) power adapter input |  |
| <b>Power</b>  | via power adapter: 6 VDC, 3 A, center-positive, included  |  |
| <b>Dimensions</b><br>(width x depth x height)                       | 16.2" x 8.6" x 1.9"<br>41.1 x 21.8 x 4.8 cm   |  |
| <b>Weight</b>   | 4.6 lb.<br>2.1 kg   |  |

## Trademarks & Licenses

Akai Professional and MPC are trademarks of inMusic Brands, Inc., registered in the U.S. and other countries.

Ableton is a trademark of Ableton AG.

ASIO and VST are trademarks of Steinberg Media Technologies GmbH.

The *Bluetooth* word mark and logos are registered trademarks owned by Bluetooth SIG, Inc. and any use of such marks by Akai Professional is under license.

MPC software incorporates *élastique Pro V3* by [zplane.development](http://zplane.development).

MPC software incorporates *STEMS EFFICIENT V1* by [zplane.development](http://zplane.development).

MPC software incorporates *STEMS PRO V1* by [zplane.development](http://zplane.development).

Apple and macOS are trademarks of Apple Inc., registered in the U.S. and other countries.

SD and SDHC are registered trademarks of SD-3C, LLC.

Windows is a registered trademark of Microsoft Corporation in the United States and other countries.

Pro Tools is a trademark of Avid Technology, Inc. in the U.S. and other countries.

All other product names, company names, trademarks, or trade names are those of their respective owners.

For complete legal information, visit [akaipro.com/product-legal](http://akaipro.com/product-legal)

## Addenda

### Updates in MPC 2.1

#### New Features

#### Exporting Expansions

You can export MPC Expansion Packs (installed on your computer) to your MPC hardware for use in its Standalone Mode. (This has been added to [Operation > Modes > Browser > Browse](#).)

#### To export MPC Expansions:

1. Connect your MPC hardware to your computer. Make sure both are powered on.
2. On your computer, open the MPC software.
3. On your MPC hardware, enter Controller Mode.
4. In the MPC software window, click the **menu icon** ( $\equiv$ ), select **File > Export**, and then click **Expansion...**
5. In the **Export Expansion to Standalone MPC** window that appears, click the **Drive** menu and select a storage device that you will use with your MPC hardware: the internal SATA drive (if you have installed one in your MPC hardware), an SD card, or a USB flash drive.
6. In the **Expansions** list, click the box next to each one to select or deselect it. Only the selected ones will be exported. Click **Select all** to select all of them or **Select none** to deselect all of them.
7. Click **Export** to start exporting, or click **Cancel** to close the window and not export anything.

The exporting process creates an **Expansions** folder at the root level of your storage device and copies your MPC Expansions into it.

**To use your expansions**, restart your MPC hardware in Standalone Mode, enter the **Browser**, and tap **Expansion**.

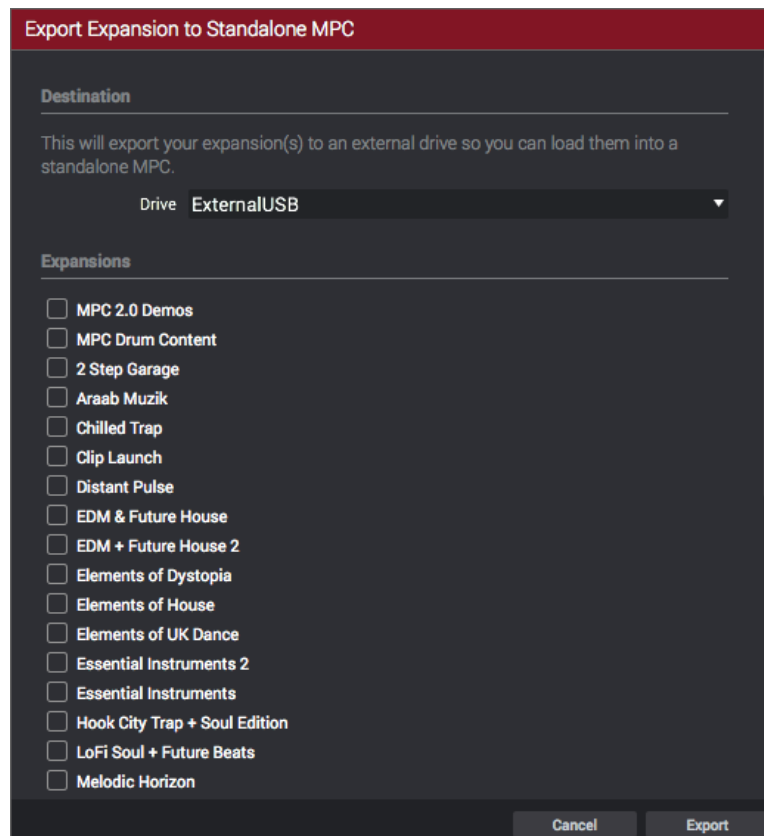



## Snap: Absolute & Relative

While editing a MIDI or audio track, you can now use the Grid View or Audio Edit Mode to move or copy events using two different ways of “snapping” note events to the grid: Absolute or Relative. (This has been added to [Operation > Modes > Grid View](#) and [Audio Edit Mode](#).)

To view the Settings, tap the gear icon.

Use the **Snap Mode** selector to set how events “snap” to the grid.

**Absolute:** Events will “snap” to the nearest time division on the grid (as determined by the **TC** field or **Time Correct** window). This is the typical and traditional method of using the snap/quantization feature.

**Relative:** Events will “snap” to the nearest time division on the grid (as determined by the **TC** field or **Time Correct** window) **plus** the original time position of the event (e.g., an event that is originally three ticks past a time division on the grid will snap only to positions that are three ticks past every time division).

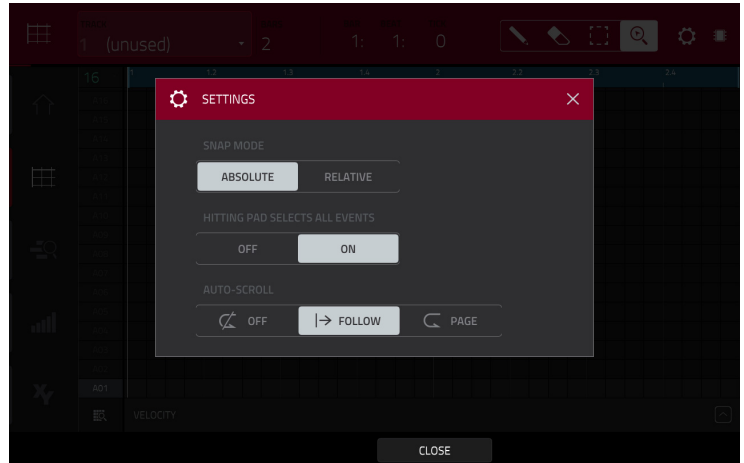

## List Edit Settings: Auto-Advance

The **Settings** window now has some additional lets you configure certain List Edit Mode settings. (This has been added to [Operation > Modes > List Edit Mode](#).)

To view the Settings, tap the gear icon.

Use the **Auto-Advance on Step Record** selector to turn the feature on or off.

When set to **On**, pressing a pad when the track is record-armed will move the audio playhead forward by a length determined by the current **Time Division** setting in the **TC/Timing Correct** window.

When set to **Off**, pressing a pad when the track is record-armed will not change the audio playhead position.

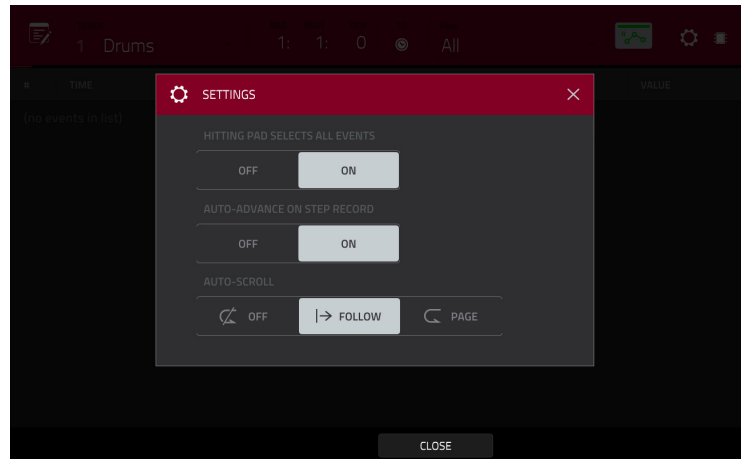

## Pitch Quantization

In a MIDI track, you can now force the pitches of note events into a specific scale. This quantization process is available with other track editing processes. (This has been added to [Operation > Modes > Main Mode > Track Section](#).)

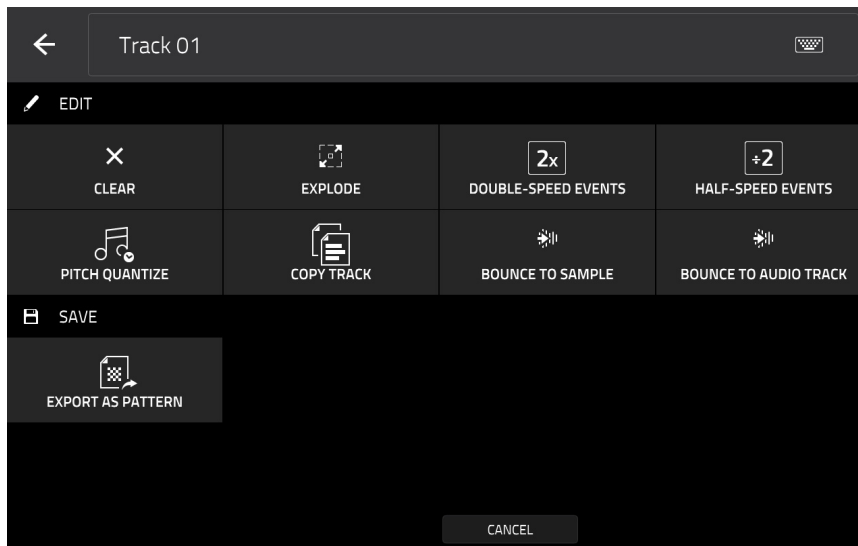

**To edit the track**, tap the **pencil icon** on the right edge of the section. The Track Edit window will open.

**To open the Pitch Quantize window**, tap **Pitch Quantize**.

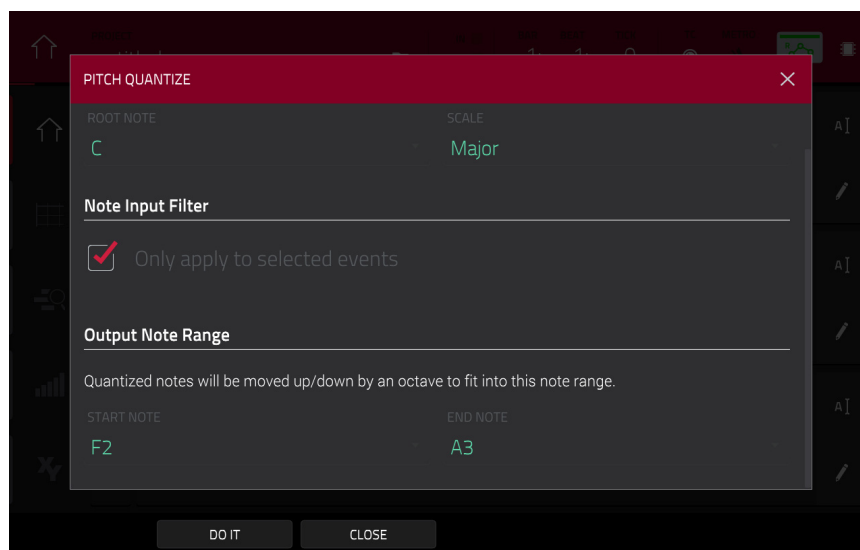

**To select the desired root note of the scale**, use the **Root Note** field.

**To select a type of scale**, use the **Scale** field.

**To determine which note events will be quantized**, tap the **Only apply to selected events** checkbox.

When **on**, only the currently selected note events will be quantized.

When **off**, all pitches in the current track will be quantized.

**To set lowest-possible and highest-possible pitches where the quantized note events will be placed**, use the **Start Note** and **End Note** fields (respectively). If a note event is originally outside of this range, it will be forced to the nearest pitch (within the scale) inside the range.

**To continue and quantize the note events**, tap **Do It**.

**To cancel**, tap **Close**.

## Step Sequencer: Velocity Adjustment via Q-Links

While using the Step Sequencer, you can now use the Q-Link knobs to adjust the velocity of the note event at each step (the Q-Link knobs must be in the **Screen** edit mode). On MPC X, the number of each step will be shown under the corresponding Q-Link knob. (This has been added to [Operation > Modes > Step Sequencer](#)).

**To adjust the velocity of each note event**, use the corresponding **Q-Link knob** to select a value (1–127).

**To enter a note event at a step**, use the corresponding **Q-Link knob** to change its velocity from **0 (Off)** to a value of **1** or greater.

**To delete a note event from a step**, set the corresponding **Q-Link knob** to its minimum position, **0 (Off)**.

## Pad Perform Mode: User Progressions

You can now use your own progressions (created in the desktop version of the MPC software) on your MPC hardware.

### To transfer progressions to your MPC hardware:

1. Connect the storage device that you will use with your MPC hardware (e.g., the internal drive, an SD card, a USB drive) to your computer.
2. On your computer, access the storage device and create a folder named **Progressions** on its root level.
3. Copy your progression files (**.progression**) from your computer to that **Progressions** folder.

By default, progressions are saved here:

**Windows:** C:\Program Files\Akai Pro\MPC\Progressions and/or C:\ProgramData\Akai\MPC\Progressions

**macOS:** ~/Library/Application Support/Akai/MPC/Progressions

4. Eject and disconnect the storage device from your computer, and connect it to your MPC hardware.

**To use your progressions**, start your MPC hardware in Standalone Mode, enter **Pad Perform Mode**, and tap **Progressions**. Your MPC hardware will scan the **Progressions** folder you created and add them to the list of available progressions.

## Faster Attack for Amp Envelopes

In the amp envelope of a drum program or keygroup program, an attack value of **0** now produces a much faster response, thus making your drum hits even punchier than before. (You can set the attack value in Program Edit Mode. See [Operation > Modes > Program Edit Mode > Drum Programs > Filter/Envelope](#) and [Keygroup Programs > Filter/Envelope](#) to learn more.)

**Important:** Any drum or keygroup programs that you created and saved before this update will load in MPC 2.1 with an attack value of **1** to ensure backwards compatibility.

## Updates in MPC 2.2

### New Features

#### MIDI Control Mode: MIDI Learn

You can now use the MIDI Learn function to assign external MIDI controllers to various parameters in your specific MPC project:

- Mixer parameters such as volume, pan, mute, and solo for MIDI or audio tracks, programs, returns, submixes, and main outputs
- Pad parameters (for drum programs and clip programs only) such as tuning, filter and amp envelopes, layer settings, LFO settings, and velocity
- Program parameters, which depend on the program type
- Insert effects parameters, which depend on the effect type

These assignments will be saved with your MPC project.

**Tip:** Because these MIDI assignments are saved within a project, you can use them while working with a project on both the desktop version of the MPC software **or** on your MPC hardware in Standalone Mode. You can also include them with a user template.

To display the MIDI Learn window, press **Menu**, tap **MIDI Control** to enter MIDI Control Mode, and then tap the **MIDI Learn** tab.

Each assignment has the following settings:

**Source:** This is the name or number of the track, program, return, submix, or main output.

**Target:** This is the name of the assigned command or parameter.

**Type:** This is the type of message:

- **Toggle Button:** When the control is a button, pressing it will activate or deactivate its command or parameter. It will remain in that state until you press it again.
- **Momentary Button:** When the control is a button, pressing and holding it down will activate its command or parameter. Releasing the button will deactivate it.
- **Fixed Button:** When the control is a button, pressing it will send its command.
- **Note:** When the control is a button, pressing it will send the MIDI note (determined by the **Data** field).
- **Abs CC:** When the control is a knob, turning it will send its CC message (determined by the **Data** field) according to the precise physical position of the knob. (When you start turning it, the value may “jump” from its current value to the one corresponding to the knob’s position.) This is for use with knobs that have a maximum and minimum position.
- **Rel CC Offset:** When the control is a knob, turning it will send the CC message (determined by the **Data** field), starting from the current value. This is for use with 360° knobs controlling parameters that have a maximum and minimum position.
- **Rel CC 2’s Complement:** When the control is a knob, turning it will send the CC message (determined by the **Data** field), starting from the current value. This is for use with 360° knobs controlling bipolar parameters where there is a center (12:00) position (e.g., panning).

This is automatically detected based on the **Source** and **Target** fields, though you can use this field to assign it manually if it does not detect it properly.

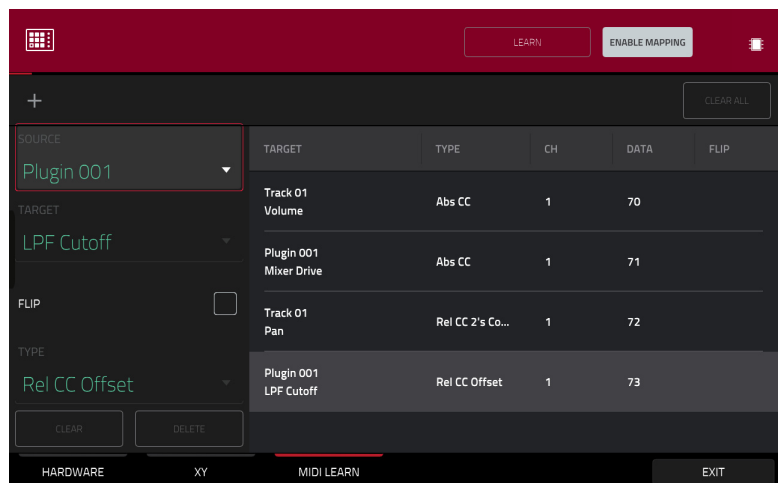

**Ch:** This is the MIDI channel the control is using.

**Data:** This is the MIDI note number or CC number.

**Flip:** Tap this box to select or deselect it. When selected, the control's polarity will be reversed (e.g., a button's "off" state will become its "on" state and vice versa).

#### To assign a parameter to a hardware control:

1. Tap **Learn** in the upper-right corner so it is **on**. (The **Enable Mapping** button will also activate if it is not already on.)
2. Tap **+** in the upper-left corner to create an "empty" assignment (its Target menu will be set to **None** and **Off**).  
Alternatively, tap an assignment that is already in the list if you want to change it.
3. Move or press the desired control on your MIDI controller. The **Type**, **Ch**, and **Data** fields will be automatically assigned.
4. Use the **Source** field to select a MIDI or audio track, program, return, submix, or main output (for drum programs and clip programs, you can select the entire program or a single pad within it). The **Target** menu will indicate the source you selected.
5. Use the **Target** menu to select the parameter. Your selection will be shown under **Target** in the list, as well.  
The control on your MIDI controller will now control the Target parameter.

**To assign more controls**, repeat **Steps 2–5**.

**To stop assigning controls**, tap **Learn** again so it turns **off**.

**To clear an assignment**, follow the steps above to reassign its **Source** field to **None** and assign its **Target** field to **Off**.

**To clear a MIDI control from an assignment**, tap it in the list, and then tap **Clear** in the lower-left corner.

**To delete an assignment** (the entire slot), tap it in the list, and then tap **Delete** in the lower-left corner.

**To delete all assignments**, press and hold **Shift**, and then tap **Delete** in the lower-left corner. In the window that appears, tap **Remove All** to continue or tap **Cancel** to not delete any assignments.

## Humanize

You can now apply randomization to the timing, length, and/or velocity of MIDI events. This process is available with other track editing processes. (This has been added to [Operation > Modes > Main Mode > Track Section](#)).

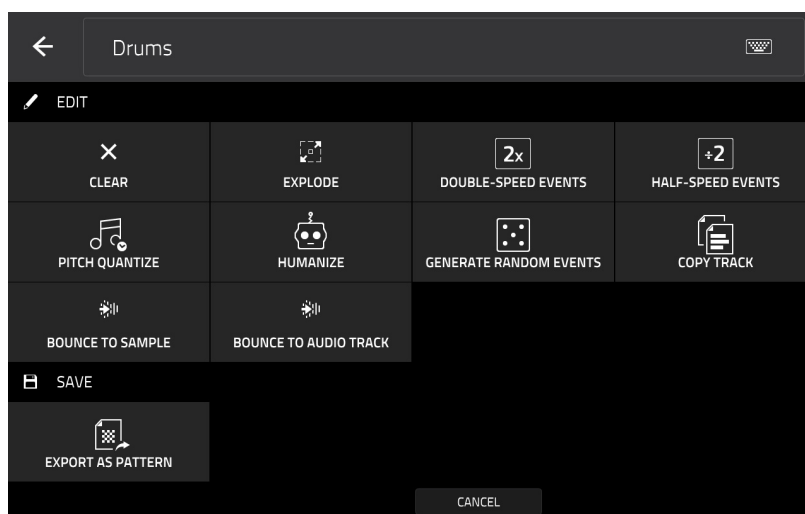

**To edit the track**, tap the **pencil icon** on the right edge of the section. The Track Edit window will open.

**To open the Humanize window**, tap **Humanize**.

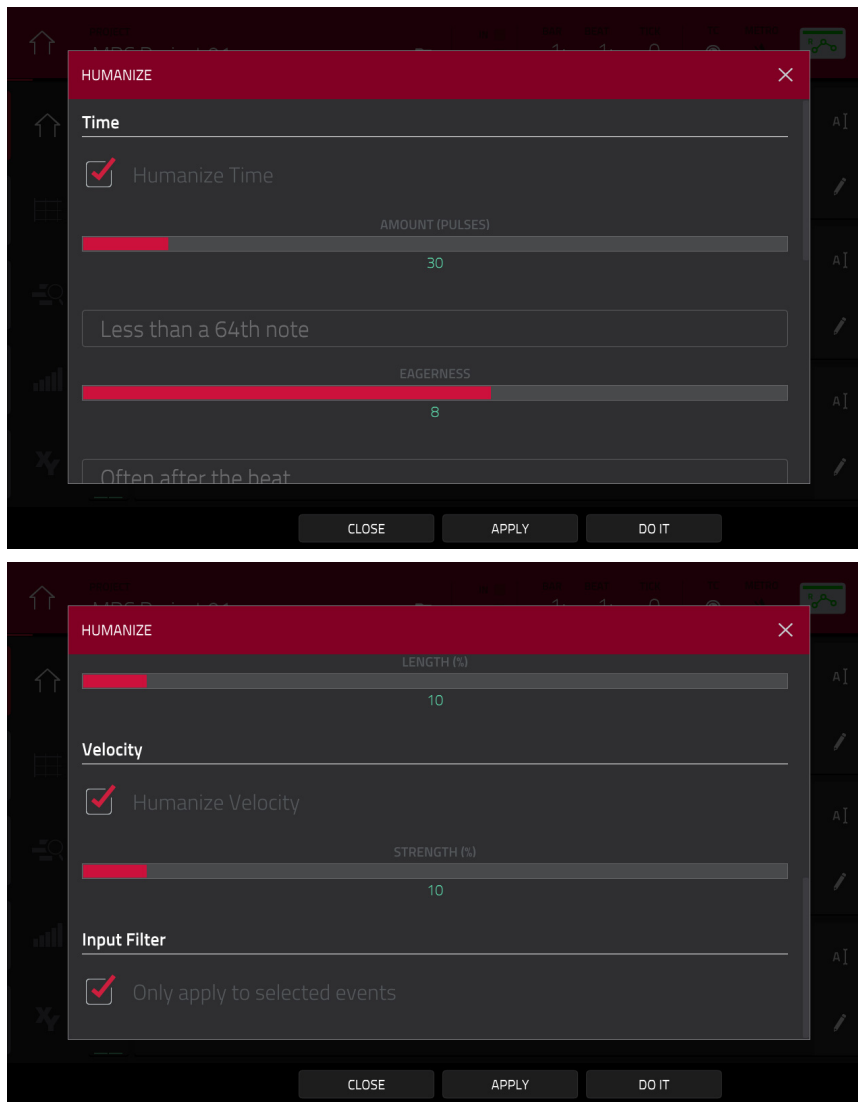

The **Humanize** function applies randomization to the timing, length, and/or velocity of MIDI note events.

**To select whether or not humanization will be applied to the timing of MIDI events**, tap the **Humanize Time** checkbox.

**To select the maximum number of pulses by which the timing of an event will be adjusted**, use the **Amount (Pulses)** slider.

**To set how dramatically the humanization effect is applied to the timing**, use the **Eagerness** slider. Negative values correspond to playing “ahead of the beat” while positive values correspond to playing “behind the beat.”

**To set whether or not humanization will be applied to the duration of MIDI note events**, tap the **Humanize Note Length** checkbox.

**To set how dramatically the humanization effect is applied to note lengths**, use the **Length (%)** slider.

**To set whether or not humanization will be applied to the velocities of MIDI note events**, tap the **Humanize Velocity** checkbox.

**To set how dramatically the humanization effect is applied to note velocities**, use the **Strength (%)** slider.

**To determine which notes will use these humanization values**, tap the **Only Apply to Selected Events** checkbox.

When **on**, just the currently selected notes will be humanized.

When **off**, all notes in the track will be humanized.

**To apply humanization and keep this window open**, tap **Apply**.

**To apply humanization and close the window**, tap **Do It**.

**To close the window without making any changes**, tap **Close**.

## Generate Random Events

You now create random melodic or drum patterns on the current MIDI track. This process is available with other track editing processes. (This has been added to [Operation > Modes > Main Mode > Track Section](#)).

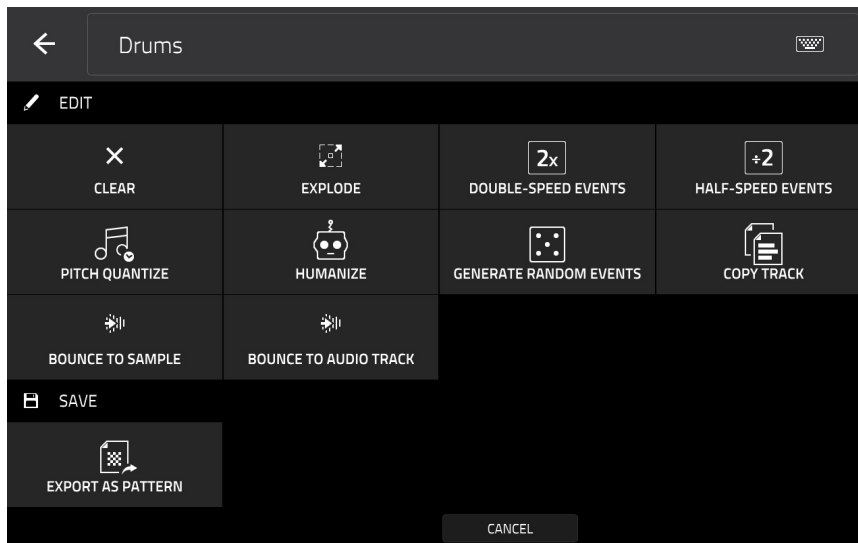

To edit the track, tap the **pencil icon** on the right edge of the section. The Track Edit window will open.

To open the **Generate Random Events** window, tap **Generate Random Events**.

The **Generate Random Events** function creates random melodic or drum patterns on the current MIDI track.

To select the type of events you want to create, use the **Event Type** field to select **Drum Events** or **Melodic Events**.

To select how the events will be created relative to the existing events on the track, use the **Replace** field:

**Replace All Events:** Select this option to replace all events on the track with the randomly generated ones.

**Replace Events in Note Range:** Select this option to replace all events in the designated note range on the track with the randomly generated ones. Use the **Bank** or **Start Pad** and **End Pad** menus to set the note range for drum events or the **Start Note** and **End Note** menus to set the note range for melodic events.

**Add to Existing Events:** Select this option to add the randomly generated events to the track without replacing or overwriting the existing ones.

To set how many bars the events will use, use the **Pattern Size (Bars)** field. The highest possible value is the number of bars in the current sequence.

To select the duration of the events, use the **Note Length** field. (This feature is nonfunctional if **Legato** is enabled while generating melodic events.)

To generate the events and keep this window open, tap **Apply**.

To generate the events and close the window, tap **Do It**.

To close the window without generating any events, tap **Close**.

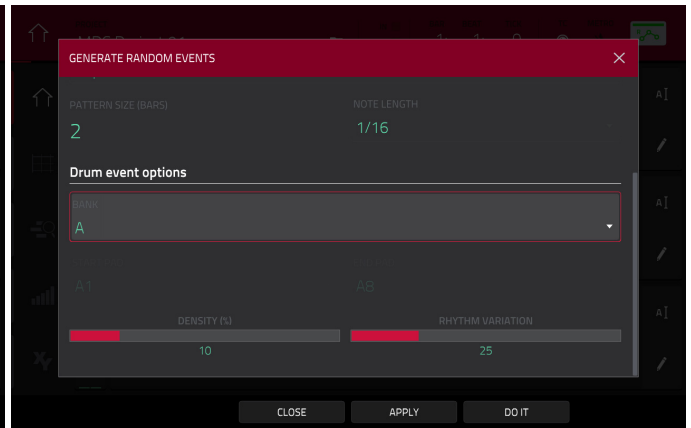
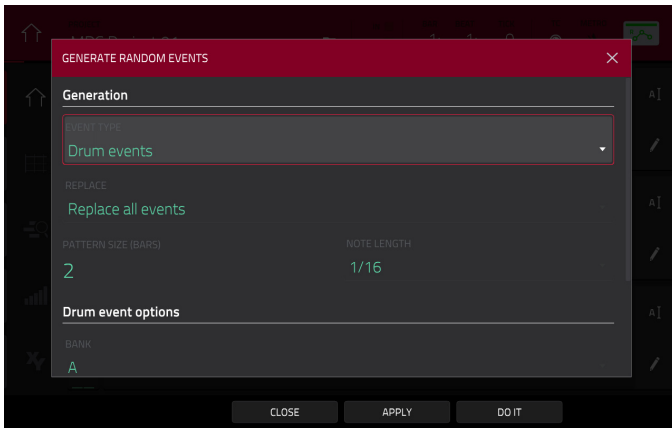

If **Event Type** is set to **Drum Events**:

To select the pad bank that will be used to generate the events, use the **Bank** field or select **Range** to use the **Start Pad** and **End Pad** menus to define a specific pad range instead.

To define a specific pad range over which the events will be generated, use the **Start Pad** or **End Pad** fields. You can use these fields only if the **Bank** menu is set to **Range**.

To set how closely together the events will be placed in the track, use the **Density (%)** slider.

To set how widely or narrowly the rhythmic patterns of the generated notes vary, use the **Rhythm Variation** slider.

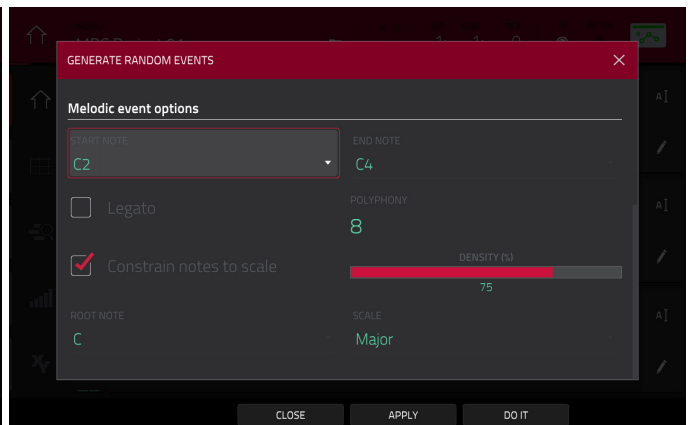
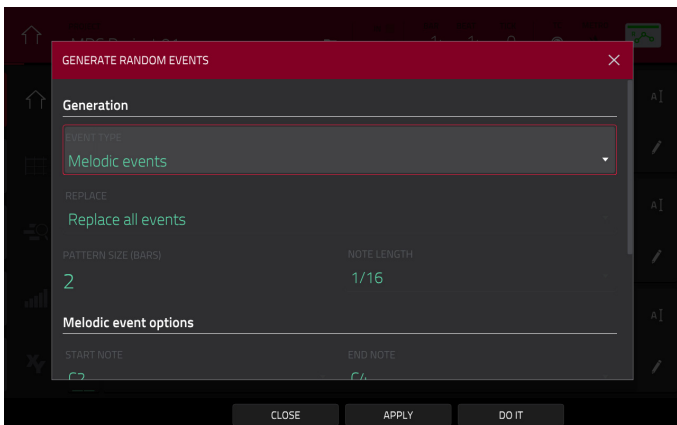

If **Event Type** is set to **Melodic Events**:

To define a specific note range over which the events will be generated, use the **Start Note** or **End Note** fields.

To enable or disable legato, tap the **Legato** checkbox.

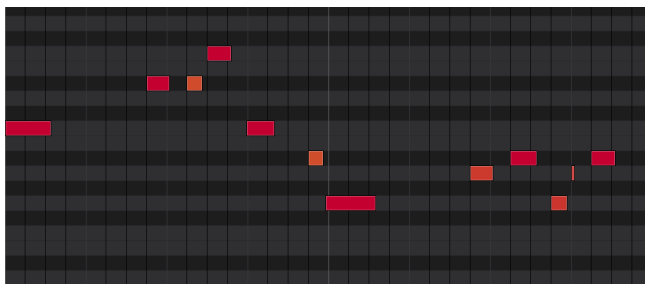

Without legato applied.

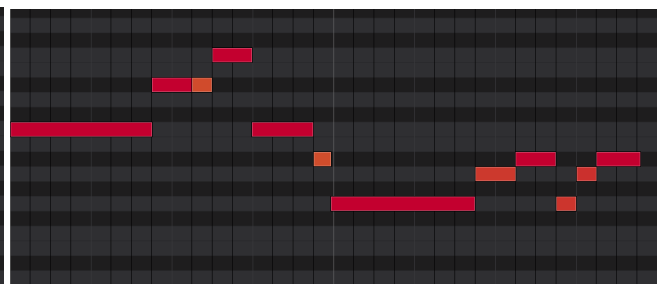

With legato applied.

When **on**, the generated notes will be extended or shortened to create a long, unbroken phrase from the first note event's start point to the last note event's end point. Each note event will sustain until another note event starts. If multiple note events start at the same time (and are not the last note events), their lengths will become identical.

When **off**, the generated notes will use the duration set by the **Note Length** menu.



To set the maximum number of note events that can be sounding simultaneously in the track, use the **Polyphony** field to select **1–8**.

To determine whether or not the notes will use a scale, tap the **Constrain Notes to Scale** checkbox.

When **on**, the notes will be within the scale determined by the **Scale** menu.

When **off**, the notes will be chromatic.

To set how closely together the events will be placed in the track, use the **Density (%)** slider.

To set the root note of the scale that the notes will use, use the **Root Note** field.

To select the scale or mode that the generated notes will use, use the **Scale** field.

## Project Template

You can now select a project file to use as a template for new projects. (This has been added to [Operation > General Features > Menu > Save](#) and [Menu > Preferences > Project Load/Save](#).)

To select a project template file, do either of the following:

1. Tap the icon in the upper-left corner to enter the **Menu**.
2. Tap the **gear icon** to enter the **Preferences**.
3. Tap **Project Load/Save**.
4. Tap the **magnifying-glass icon** next to the **Template File** field to select the project you want to use as a template.
  1. In Main Mode, tap the **Project** field in the upper-left corner.
  2. Tap **Save As...** at the bottom of the screen.
  3. Tap the **Save as Template** checkbox to check it.
  4. Name and select a location for the project, as usual.
  5. Tap **Save**. (The file will now be shown in the **Template File** field in the Preferences' **Project Load/Save** tab.)

To load the project template from the startup screen (when you power on your MPC hardware), tap **User Template** at the bottom of the screen. In order for this option to be available, **New Project Dialog** (in the **Project Defaults** tab) in the **Preferences** must be set to **Demo** or **Demo/Template/Recent**.

## Updates in MPC 2.3

### New Features

#### Arpeggiator

MPC now includes a full-featured arpeggiator and phrase player for melodic program types.

##### To open the Arpeggiator settings:

1. Set the current track type to **Plugin, Keygroup, MIDI, or CV**.
2. Open the Arpeggiator window by doing either of the following:
  - Press and hold the **Note Repeat** button, then tap **Arp** at the bottom-right of the screen.
  - Alternatively, press the **Arpeggiator F-Key (MPC X)**.

To activate the Arpeggiator, tap **Enable** so it is checked. Tap again to **Disable** the Arpeggiator.

To latch the Arpeggiator, tap **Latch** so it is checked. Tap again to **Disable** Latch.

The **Setup** section of the Arpeggiator window sets what kind of arpeggiator will be used and its functions:

Use the **Action** field to set the type: **Arp**, **Note Repeat**, **Rhythm** and **Pattern**. See [below](#) for more details about these types and their additional parameters.

Use the **Step Size** field to set the note value of each arpeggiator step from **1/1–1/64** beats, including **T** (triplet) variations. This field is not used in Pattern mode.

Use the **Note Length** slider to set the length of the played note in each step, from **1–100%**.

Use the **Velocity** field to set the velocity of the arpeggiator notes. Choose **As played**, **From first note**, **Accented**, **Full**, **3/4**, **Half** or **1/4**.

Use the **Swing** field to set the amount of swing in the arpeggiator from **50% to 75%**. Swing lets you "shuffle" your beats—from subtle to extreme.

The **Arp mode** section of the Arpeggiator window is available when the **Action** is set to **Arp**. When this action is selected, hold down a chord and the arpeggiator will play a pattern based on the notes held.

Use the **Pattern** field to set how the arpeggiator triggers the held notes.

Use the **Octaves** field to set how many octaves of the held notes the arpeggiator will cycle through.

Use the **Variation** field to apply rhythmic variation to the set pattern.

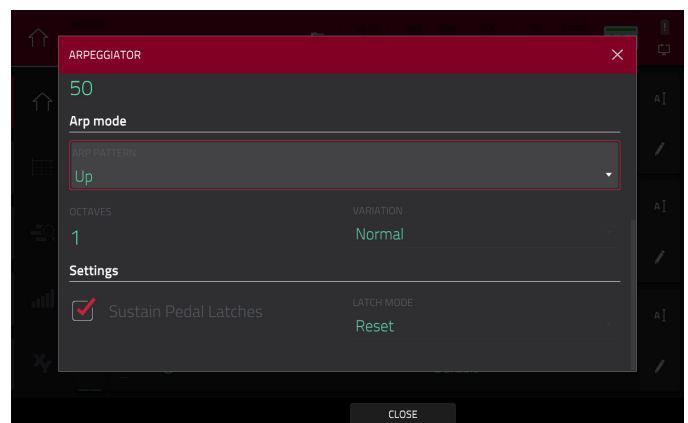
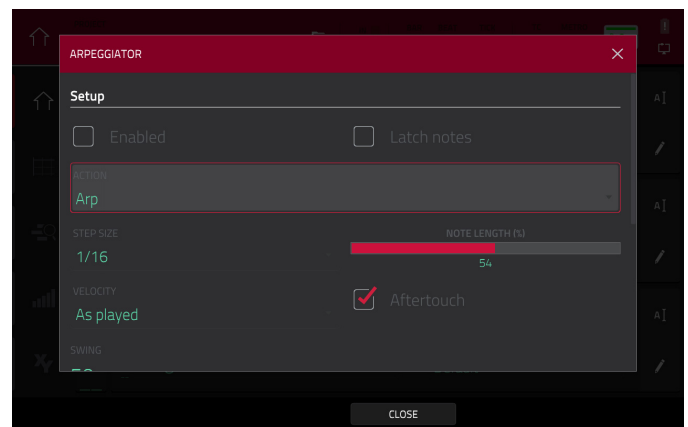

The **Rhythm** section of the Arpeggiator window is available when **Action** is set to **Note Repeat** or **Rhythm**. The Note Repeat action provides traditional MPC Note Repeat behavior. When the Rhythm arpeggiator action is selected, hold down a chord and the arpeggiator will play the held notes in a rhythmic pattern.

Use the **Spread** field to spread the timing of the held notes, creating a glissando effect.

Use the **Rhythm Pattern** field to choose the pattern played when notes are held. This is only available for the **Rhythm** action.

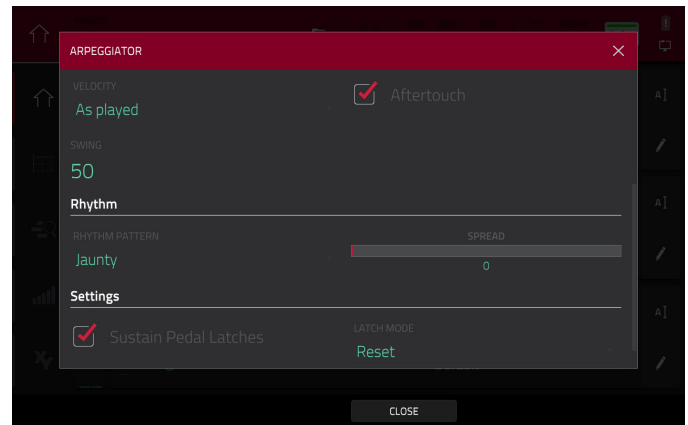

The **Pattern** section of the Arpeggiator window is available when the **Action** is set to **Pattern**. When this arpeggiator action is selected, hold down a single note to trigger a melodic phrase. As you change what note is held, the melodic phrase will be transposed.

Use the **Pattern** field to choose the pattern.

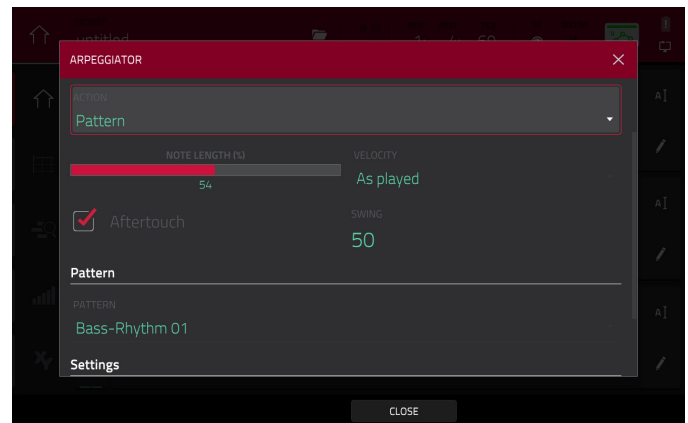

The **Settings** section of the Arpeggiator window offers additional options to control the arpeggiator.

If you have a sustain pedal connected, you can enable **Sustain Pedal Latches** to use it to control latching.

Use the **Latch Mode** setting to set the latch behavior. When set to **Reset**, adding a new note(s) will reset the currently latched note(s). When set to **Add**, new notes will be added to currently latched notes.

Tap **Close** to close the Arpeggiator window.

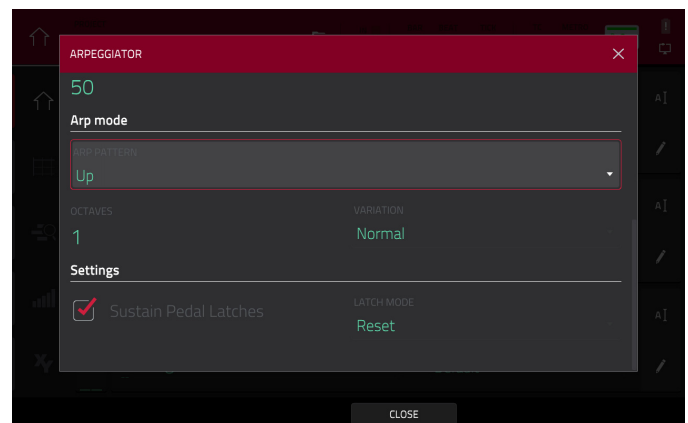

## Auto Sampler

You can now capture and convert any plugin preset or external instrument preset into a Keygroup sampler patch.

### To open the Auto Sampler:

1. Open the Sampler mode by doing either of the following:
  - Press **Menu** and then tap **Sampler**.
  - Press **Sampler** (MPC X).
2. Press the **Auto Sampler** icon in the toolbar.

### Sample Source Information

The **Track name** and **Program name** fields show the target track and program that will be sampled. This will be automatically selected as the active track and program when Auto Sampler is opened.

Use the **Record from** field to select an external or resample input to record from:

**To capture the output of a plugin**, simply select a Plugin track before opening Auto Sampler.

**Note:** When a plugin track is selected, the Auto Sampler will only sample the plugin track, regardless of the setting in the **Record From** field.

**To capture a preset from an external instrument such as a sound module**, select the **Input** that the external instrument is connected to.

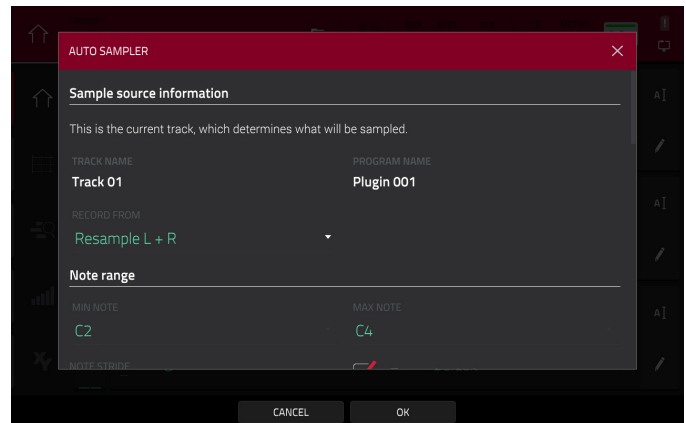

### Note Range

Use the **Min note** and **Max note** settings to determine the lowest and highest notes used to create the sampler patch.

Use the **Note stride** to determine the range of notes that each sample will cover. For instance, a note stride of **5** means that every 5 notes will utilize a different sample.

Check the **Extend min/max notes** box to sample all the way to the lowest and highest notes, regardless of the **Min Note** and **Max Note** settings.

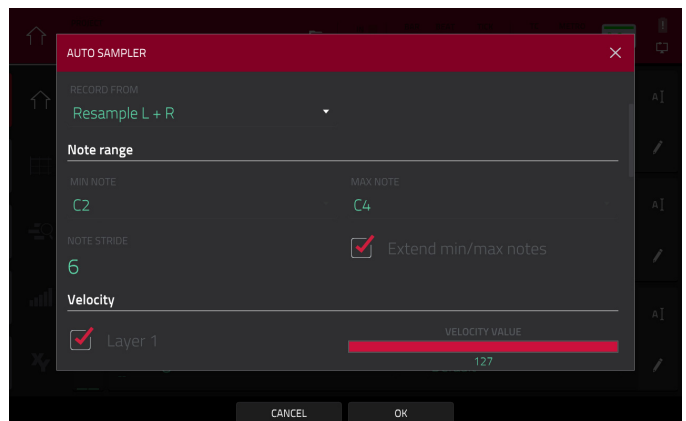

### Velocity

Tap the boxes next to **Layers 1–4** to select how many layers will be used to create the sampler patch.

Use the **Velocity** value sliders to set the velocity of each layer.

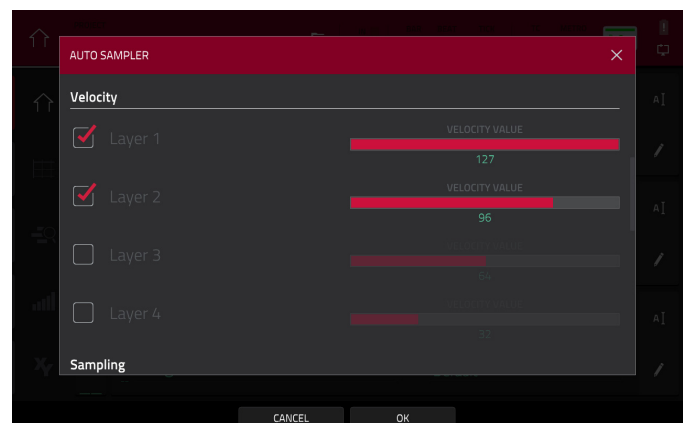

## Sampling

Use the **Note length** slider to set the length of the sampled note in seconds.

Use **Tail** slider to set the length of the Audio Tail in seconds. This will add extra seconds to the end of the resulting audio file. This is useful if you are capturing samples whose sounds exceed the defined audio length (e.g., long reverb or delay, one-shot samples with long decays, etc.). We recommend using an audio tail of at least a couple of seconds.

Use **Base name** to set the naming convention for the samples that will be created by the Auto Sampler.

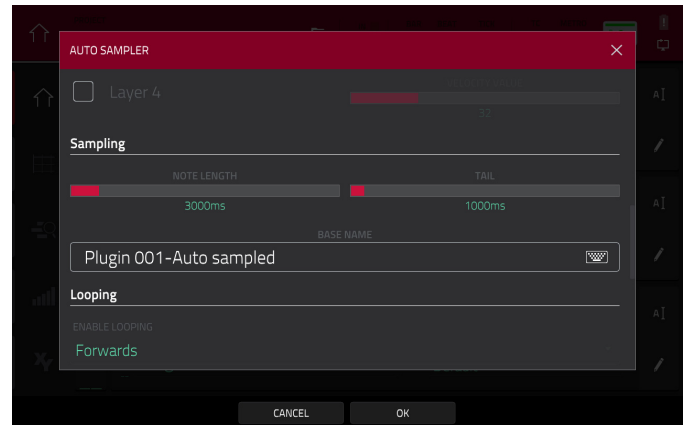

## Looping

Use the **Enable looping** field to select how the resulting samples can or cannot be looped:

- **Off:** The sample will not loop.
- **Forward:** You can hold down the **pad** to cause that sample to repeat from the **Loop Position** to the end of the sample. Release the **pad** to stop the repeating playback.
- **Reverse:** You can hold down the **pad** to cause that sample to play in reverse, repeating from the end of the sample to the **Loop Position**. Release the **pad** to stop the repeating playback.
- **Alternating:** You can hold down the **pad** to cause that sample to play from the **Loop Position** to the end of the sample and then play in reverse until it reaches the **Loop Position** again. This will repeat as long as you are holding the **pad** down. Release the **pad** to stop the repeating playback.

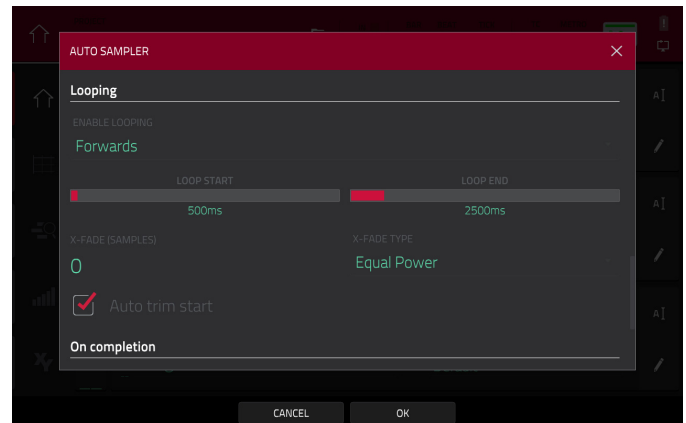

Use the **Loop start** and **Loop end** sliders to set the starting and ending points in the sample where the loop will occur.

Use the **Crossfade** field to set the amount of crossfade between the loop end and loop start in seconds.

Use the **Crossfade Type** field to select **Equal Power** or **Linear** crossfade.

Under **On completion**, check **Make current program** to load the completed sampler patch as the current program.

Under **Info**, the **Session Duration** field provides an estimate of how long the auto sampling process will take.

Tap **OK** to initiate the auto sampling process. A Progress window will appear. Click **Cancel** to stop the auto sampling process. Any samples already created will be retained.

Tap **Cancel** to close the Auto Sampler window without continuing.

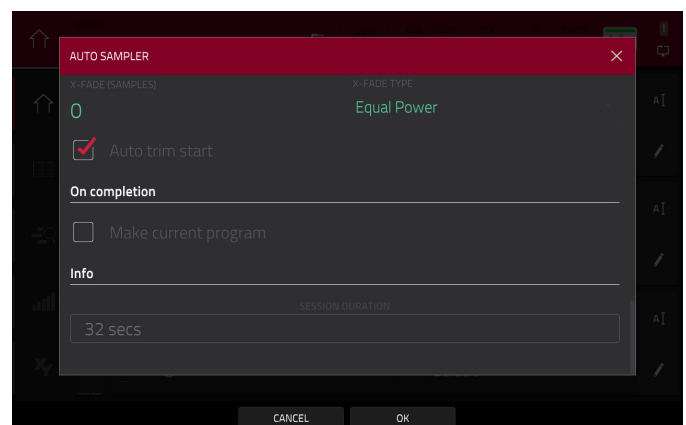

## Crossfade Looping

You can now add real time crossfade looping to sample playback.

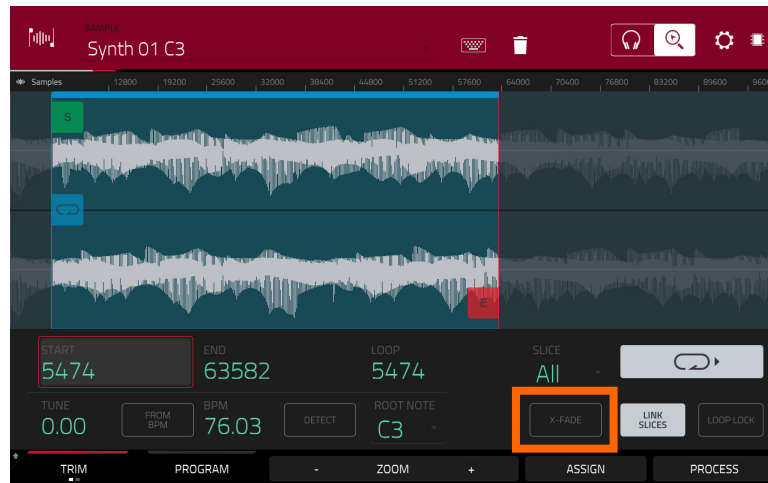

### To apply crossfade looping to a sample:

1. Open Sample Edit mode by doing either of the following:
  - Press **Menu**, and then tap **Sample Edit**.
  - Press **Sample Edit** (MPC X).
2. Make sure the loop **Lock** setting is set to **Off**.
3. Tap the **Loop** button to select the **Forward (FWD)** loop mode.
4. Make sure there is at least 10 samples of space between the **Start** point and **Loop** point.
5. Tap the **X-Fade** button to open the X-Fade window:

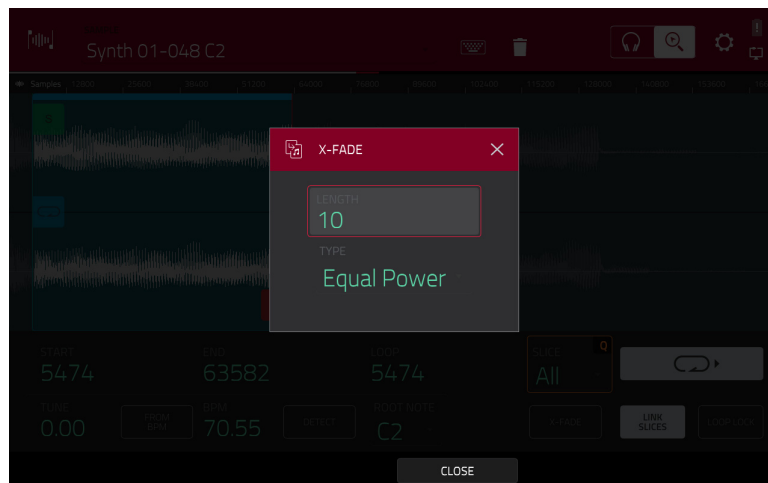

To set the length of the crossfade in samples, use the **Length** field.

To set the type of crossfade, use the **Type** field. Select **Equal Power** or **Linear**.

To close the window and return to **Trim Mode**, tap the **X** or tap **Close**.

When you are finished, press **Pad A16 – Play Continuous Loop** in Sample Edit Trim Mode to hear the crossfade applied to the sample.

## Mode Selection Shortcut

You can now press and hold the **Menu** button on your MPC hardware and press a pad to select a menu mode. The pads follow the 4x4 layout of the Mode Menu.

## Pad Perform Mode: Chromatic Type

You can now use Pad Perform Mode to set the pads to follow a chromatic layout. When the **Chromatic** type is selected, each pad is assigned a note, ascending by one semitone with each pad. Pads with notes in the key determined by the **Scale** will be lit, while pads with notes between the scale degrees will be unlit.

## Q-Link Navigation Enhancements

Q-Link functionality has been enhanced in the following modes: Main Mode, Track View, Next Sequence, Grid Editor, and Audio Edit Mode.

Set the **Q-Link Mode** to **Screen** in these pages to access the following controls:

- Use **Q-Link Knob 2** to adjust the playhead position.

- Use **Q-Link Knob 3** to scroll through the waveform in the large waveform display.

- Use **Q-Link Knob 4** to zoom in or zoom out at the playhead position.

**Note:** For MPC hardware in standalone mode, the **Zoom** and **Scroll** Q-Links are only available in the Grid Editor and Audio Edit Mode.

## Split Events

You can now easily split note events, useful for creating intricate hi-hat parts or quintuplet/sextuplet motifs or drum beats. (This has been added to **Operation > Modes > Main Mode > Track Section.**)

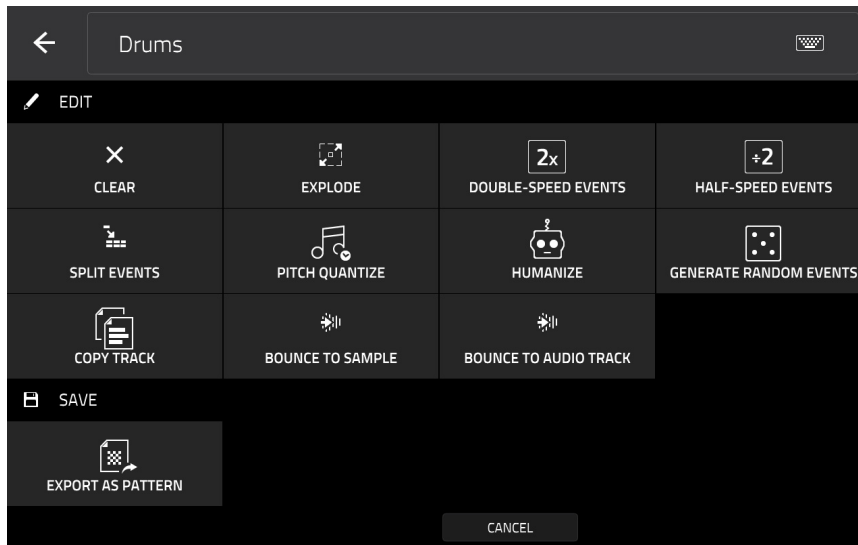

To edit the track, tap the **pencil icon** on the right edge of the Main Mode screen. The Track Edit window will open.

To open the Split Events window, tap **Split Events**.

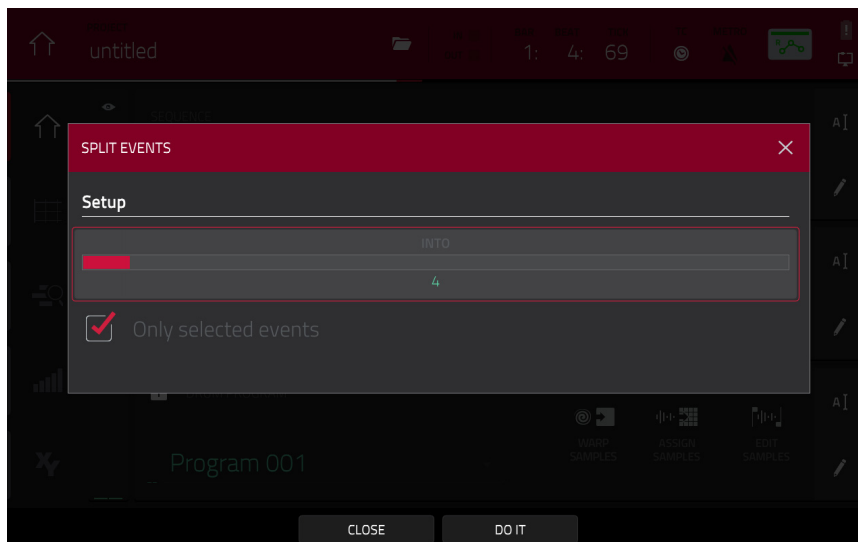

To set how many events notes will be divided into, use the **Into** slider.

To determine which notes will be divided, tap the **Only selected events** checkbox.

To split the events and close the window, tap **Do It**.

To close the window without making any changes, tap **Close**.



## AIR Instrument Plugins

MPC now includes three new plugin instruments: AIR TubeSynth, AIR Bassline, and AIR Electric.

### AIR Bassline

The AIR Bassline plugin emulates the sound of classic mono synths, with a contemporary twist. Bassline also comes packaged with four integrated AIR effects (Chorus, Delay, Compressor and Hype), as well as two built-in distortion algorithms (Overdrive and Clip).



### Osc/Filter/Envelope

Use this tab to adjust the settings for the oscillators, as well as their filter and envelope settings.

| Parameter  | Description    | Value Range   |                                    |
|------------|----------------|---|------------------------------------|
| Oscillator | Waveform       | Continuously variable waveshape for the oscillator.   | Saw Octave, Saw, Square, Sine      |
|            | Sub-Octave     | Amount of sub-octave oscillator.  | 0–100%                             |
|            | Fifth          | Amount of fifth-oscillator.   | 0–100%                             |
|            | Start Phase    | Position of the waveform when a note is triggered.  | Free, 0 degr., 180 degr.           |
|            | Glide Time     | Amount of time to slide from the pitch of one note to the next note played.   | 10.0 ms – 2.00 s                   |
|            | Boost          | Boosts the signal of the oscillator.  | 0.0 – 48.0 dB                      |
|            | Boost Freq.    | Center frequency of the boost.  | * 1.0 – * 240.0                    |
| Filter     | Boost Envelope | Amount of effect of the envelope on the Boost section. Adjust <b>Gain</b> to control the amount of boost. Adjust <b>Frequency</b> to control the center frequency of the boost. | Gain 0–100%, Off, Frequency 0–100% |
|            | LP Cutoff      | Cutoff frequency for the low-pass filter.   | 20.0 Hz – 20.0 kHz                 |
|            | Reso           | Resonance of the filter.  | 0–100%                             |
|            | Filter Env     | Envelope of the filter. At negative values, decreases the cutoff value based on the decay value. At positive values, increases the cutoff value based on the decay value.       | -100% – 0 – +100%                  |
| Envelope   | HP Cutoff      | Cutoff frequency for the high-pass filter.  | 10.0 – 500 Hz                      |
|            | Amp Attack     | Length of time for the note to reach full volume.   | 0–100 Soft, 0–100% Hard            |
|            | Amp Decay      | Length of time for the note to reach the sustained volume.  | 0–100%                             |
|            | Filter Decay   | Length of time for the filter to reset after being released.  | 0–100%                             |
|            | Pitch Mod      | Amount of pitch modulation applied to the envelope.   | 0–100%                             |

## Velocity/Global/Chorus

Use this tab to adjust the Velocity Control settings and Global volume. You can also apply and adjust the settings for the built-in Chorus effect.

| Parameter | Description    | Value Range  |                    |
|-----------|----------------|--|--------------------|
| Velocity  | Amp Control    | The amount of effect velocity has on amplitude control.  | 0–100%             |
|           | Filter Control | The amount of effect velocity has on filter control.   | 0–100%             |
|           | Boost Control  | The amount of effect velocity has on boost control.  | 0–100%             |
|           | Env Retrigger  | Sets whether the envelope will retrigger when a note is played while another note is being held. | Off, On            |
| Global    | Global Volume  | Sets the volume level.   | -Inf dB – +6.0 dB  |
|           | Drive Type     | Choose one of two drive algorithms.  | Overdrive, Clip    |
|           | Drive Amount   | Amount of drive applied.   | 0–100%             |
|           | Bend Range     | Number of semitones up or down controlled by MIDI pitch bend messages.                           | 0–12               |
| Chorus    | Rate           | Modulation speed of the chorus effect.   | 20.0 Hz – 20.0 kHz |
|           | Depth          | Modulation depth of the chorus effect.   | 0–100%             |
|           | Mix            | Wet/dry amount of the chorus effect.   | -100% – 0 – 100%   |
|           | On/Off         | Enables or disables the effect.  | Off, On            |

## Delay

Use this tab to apply and adjust the settings for the built-in delay effect.

| Parameter | Description  | Value Range   |
|-----------|--|---|
| Time      | Length of time of the delayed signal.  | When <b>Sync</b> is set to <b>Free</b> : 1 ms – 2.00 s<br>When <b>Sync</b> is set to <b>Sync</b> : 1/32 – 8/4 |
| Sync      | Sync the Delay <b>Time</b> to the <b>Global Tempo</b> or set to <b>Free</b> to adjust <b>Time</b> by milliseconds.                       | Free, Sync  |
| Mix       | Wet/dry amount of the delay effect.  | 0–100%  |
| Feedback  | Amount of signal fed back into the delay line.   | 0–100%  |
| Damp      | Center frequency of where the delay signal will be dampened.   | 1.00 – 20.0 kHz   |
| Reso      | Amount of resonance of the feedback signal.  | 0–100%  |
| Reso Freq | Center frequency for feedback resonance.   | 100 Hz – 10.0 kHz   |
| Ratio     | Reduces the delay <b>Time</b> in either the <b>Left</b> or <b>Right</b> stereo field. This is useful for creating offset, panned delays. | L 50:100, R 50:100  |
| HPF       | Center frequency for delay signal high-pass filter.  | 20.0 Hz – 1.0 kHz   |
| Width     | Stereo width of delay signal. Higher values give wider stereo separation.  | 0–100%  |
| On/Off    | Enables or disables the effect.  | Off, On   |

**Compressor/Hype**

Use this tab to apply and adjust the settings for the built-in Compressor and Hype effects.

| <b>Parameter</b> | <b>Description</b> | <b>Value Range</b>  |                  |
|------------------|--------------------|---|------------------|
| Compressor       | Threshold          | Signal level after which the compressor will be applied.  | 0.0 – -60. dB    |
|                  | Ratio              | Amount of compression applied.  | 1.0:1 – 100.0:1  |
|                  | Output             | Amount of additional output gain for the compressed signal.   | 0.0 – 30.0 dB    |
|                  | Mix                | Wet/dry mix of the compressor effect.   | 0–100%           |
|                  | Knee               | How gradually the compressor reacts as the threshold is reached.<br><br>Lower values apply a "soft" knee (compression is applied more slowly as signal approaches the threshold), and higher values apply a "hard" knee (compression is immediately applied when the threshold is reached). | 0–100%           |
|                  | Attack             | Length of time to apply the compression.  | 100 us – 300 ms  |
|                  | Release            | Length of time for compressed signal to return to original level.   | 10 ms – 4.00 s   |
|                  | On/Off             | Enables or disables the effect.   | Off, On          |
| Hype             | High               | Dampens or maximizes high end frequencies.  | -100 – 0 – +100% |
|                  | Low                | Dampens or maximizes low end frequencies.   | -100 – 0 – +100% |
|                  | On/Off             | Enables or disables the effect.   | Off, On          |

## AIR Electric

The AIR Electric plugin emulates the sound of classic electric pianos. Dedicated Pickup, Envelope, Bell and Noise parameter sections provide a huge amount of flexibility to configure the timbre of the electric piano sound. Electric also includes five AIR effects: Tremolo, Tube Distortion, Chorus, Delay and Spring Reverb.

While viewing any of the tabs listed below, you can quickly enable or disable the **Bell** and **Noise** sounds, as well as the built-in effects (**Tremolo**, **Tube**, **Chorus**, **Delay** and **Spring Reverb**).

When viewing a specific tab, you can enable or disable the sound or effect by pressing the circle in the upper-right corner of each section.

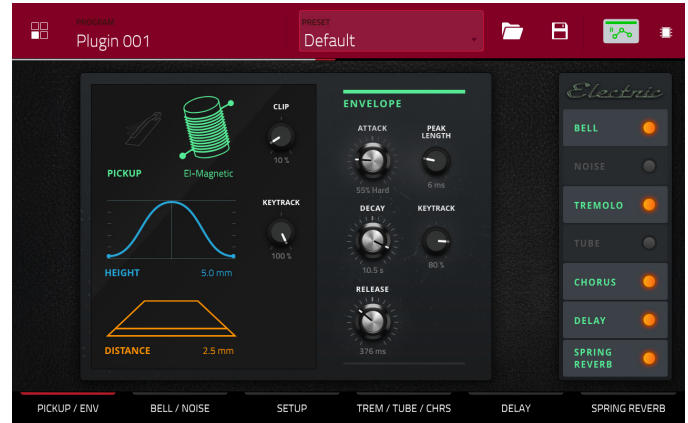

### Pickup/Env

Use this tab to edit the settings for the emulated pickup and the sound envelope.

| Parameter |             | Description   | Value Range  |
|-----------|-------------|---|--|
| Pickup    | Type        | Type of pickup emulated.  | Pickup, 0–100% Electro-Static, 0–100% Electro-Magnetic |
|           | Height      | Height of the pickup to the tines.  | 0.0 – 5.0 mm   |
|           | Distance    | Distance of the pickup to the tines.  | 0.1 – 10.0 mm  |
|           | Clip        | Amount of clipping applied to the signal.   | 0–100%   |
|           | Keytrack    | Ties the pickup parameters to the pitch being played. At higher values, the <b>Distance</b> is increased as the pitch is increased. | 0–100%   |
| Envelope  | Attack      | Length of time for the note to reach full volume.   | 100–0% Hard, 0–100% Soft                               |
|           | Decay       | Length of time for the note to reach the sustained volume.  | 100 ms – 20.0 s  |
|           | Release     | Length of time for the note to become silent after being released.  | 100 ms – 5.0 s   |
|           | Peak Length | Length of time full volume is held before decaying.   | 3–50 ms  |
|           | Keytrack    | Ties the envelope parameters to the pitch being played. At higher values, the envelope time is decreased as the pitch is increased. | 0–100%   |

**Bell/Noise**

Use this tab to apply and adjust the settings for the Bell and Noise sounds.

| Parameter |               | Description  | Value Range             |
|-----------|---------------|--|-------------------------|
| Bell      | Tune          | Pitch of the bell sound, in semitones above the root pitch.  | 0– 60 semitones         |
|           | Dry/PU        | Mix of Dry versus Pickup signal for the bell sound.  | -100% – 0% – +100%      |
|           | Volume        | Level of the bell sound.   | -Inf dB – 0.0 – +6.0 dB |
|           | Tune Keytrack | Ties the tuning of the bell sound to the pitch being played.   | 0–100%                  |
|           | Decay         | How long it takes for the bell sound to dissipate.   | 100 ms – 7.0 s          |
|           | Keytrack      | Ties the amount of bell sound to the pitch being played.<br>At negative values, the bell sound is increased as the pitch increases.<br>At positive values, the bell sound is increased as the pitch decreases. | -100% – 0% – +100%      |
| Noise     | Freq          | Center frequency of the noise effect.  | 200 Hz – 16.0 kHz       |
|           | Random        | Amount of randomization applied to the noise effect.   | 0–100%                  |
|           | Mix           | Level of noise effect present.   | -Inf dB – 0.0 – +6.0 dB |
|           | Attack        | Length of time for the noise effect to reach full level.   | 1–50 ms                 |
|           | Decay         | Length of time for the noise effect to dissipate.  | 100 ms – 3.00 s         |
|           | Keytrack      | Ties the <b>Freq</b> to the pitch being played.  | 0–100%                  |

**Setup**

Use this tab to adjust general settings for the plugin.

| Parameter   | Description   | Value Range             |
|-------------|---|-------------------------|
| Polyphony   | Number of voices available.   | 1–16 Voices             |
| Level       | Overall level of the plugin.  | -Inf dB – 0.0 – +6.0 dB |
| Velo Level  | Adjusts how much incoming velocity is applied.  | 0–100%                  |
| Velo Tone   | Ties the incoming velocity to tone.<br>At higher values, increased velocity increases tone brightness.                | 0–100%                  |
| Velo Attack | Ties the incoming velocity to the attack envelope.<br>At higher values, lower velocities feature longer attack times. | 0–100%                  |

**Trem/Tube/Chorus**

Use this tab to apply and adjust the settings for the built-in Tremolo, Tube (Overdrive), and Chorus effects.

| Parameter | Description | Value Range  |
|-----------|-------------|--|
| Tremolo   | Rate        | Modulation speed of the effect.<br>When <b>Sync</b> is set to <b>Free</b> : 0.25 – 13.00 Hz<br>When <b>Sync</b> is set to <b>Sync</b> : 8/4 – 1/16 |
|           | Sync        | Sync the Tremolo <b>Rate</b> to the <b>Global Tempo</b> or let it run <b>Free</b> . Free, Sync   |
|           | Mode        | Select <b>Pan</b> for stereo field modulation, or <b>Tremolo</b> for amplitude modulation. Pan, Tremolo  |
|           | Depth       | Amount of modulation applied. 0–100%   |
| Tube      | Drive       | Amount of drive applied. 0–100%  |
|           | Headroom    | Amount of gain reduction between the clean signal and the driven signal. -30.0 – 0.0 dB  |
|           | Saturation  | Amount of saturation applied. 0–100%   |
|           | Output      | Output level of the tube driven signal. -20.0 – 0.0 – +20.0 dB   |
| Chorus    | Rate        | Modulation speed of the effect. 0.40 – 3.20 Hz   |
|           | Depth       | Amount of pitch modulation of the effect. 0–100%   |
|           | Mix         | Wet/dry amount of the chorus effect. 0–100%  |

**Delay**

Use this tab to apply and adjust the settings for the built-in Delay effect.

| Parameter | Description  | Value Range |
|-----------|--|-------------|
| Time      | Amount of time between the dry signal and the delayed signal.<br>When <b>Sync</b> is set to <b>Free</b> : 1 ms – 2.00 s<br>When <b>Sync</b> is set to <b>Sync</b> : 1/32 – 8/4 |             |
| Sync      | Sync the Delay <b>Time</b> to the <b>Global Tempo</b> or set to <b>Free</b> to adjust <b>Time</b> by milliseconds. Free, Sync  |             |
| Mix       | Wet/dry amount of the delay effect. 0–100%   |             |
| Feedback  | Amount of signal fed back into the delay line. 0–100%  |             |
| Damp      | Center frequency of where the delay signal will be dampened. 1.00–20.0 kHz   |             |
| Reso      | Amount of resonance of the feedback signal. 0–100%   |             |
| Reso Freq | Center frequency for feedback resonance. 100 Hz – 10.0 kHz   |             |
| Ratio     | Reduces the delay <b>Time</b> in either the <b>Left</b> or <b>Right</b> stereo field. This is useful for creating offset, panned delays. L 50:100, R 50:100                    |             |
| HPF       | Center frequency for delay signal high-pass filter. 20.0 Hz – 1.0 kHz  |             |
| Width     | Stereo width of delay signal. Higher values give wider stereo separation. 0–100%   |             |

## Spring Reverb

Use this tab to apply and adjust the settings for the built-in Spring Reverb effect.

| Parameter | Description   | Value Range        |
|-----------|---|--------------------|
| Pre-Delay | Length of time between dry signal and reverberated signal.  | 0–250 ms           |
| Time      | Length of reverb tail.  | 1.0 – 10.0 s       |
| Mix       | Wet/dry amount of the reverb effect.  | 0–100%             |
| Diffusion | Rate of increasing density of reverb reflections.<br>At lower settings, the sound of individual reflections is more present.<br>At higher settings, reflections are more uniform. | 0–100%             |
| Width     | Stereo width of reverb signal. Higher values give wider stereo separation.  | 0–100%             |
| Low Cut   | Center frequency for reverb signal low-cut filter.  | 20.0 Hz – 1.00 kHz |

## AIR TubeSynth

The AIR TubeSynth plugin emulates the sound of classic vintage analog polysynths. TubeSynth is based on the highly acclaimed AIR Vacuum Pro desktop synth plugin and also includes 5 integrated AIR effects.

### Oscillator

Use this tab to adjust the settings for the two variable Oscillators and the Sub Oscillator.



| Parameter      | Description  | Value Range   |                              |
|----------------|--------------|---|------------------------------|
| Oscillator 1   | Octave       | Coarse tuning of the oscillator by octaves. The <b>Wide</b> setting provides additional <b>Fine</b> tuning controls.  | Wide, 32', 16', 8', 4', 2'   |
|                | Fine         | Fine tuning of the oscillator by semitones.<br>When <b>Octave</b> is set to <b>Wide</b> : -70.00 – 0.00 – +70.00<br>When <b>Octave</b> is set to <b>32'–2'</b> : -12.00 – 0.00 – +12.00 |                              |
|                | Shape        | Waveshape of Oscillator 1 (continuously variable).  | Triangle, Saw, Square, Pulse |
|                | F-Env→Shape  | Amount of Filter Envelope output subtracted from or added to the value defined by the Osc 1 <b>Shape</b> parameter.   | -100 – 0 – +100%             |
|                | Quad         | Enables or disables four-voice emulation for the oscillator.  | Off, On                      |
|                | Detune       | Adjusts tuning of the additional <b>Quad</b> voices.  | 0–100%                       |
| Oscillator 2   | Octave       | Coarse tuning of the oscillator by octaves all the way down to LFO speed.   | LFO, 32', 16', 8', 4', 2'    |
|                | Fine         | Fine tuning of the oscillator.<br>When <b>Octave</b> is set to <b>LFO</b> : 0.01 – 20.00 Hz<br>When <b>Octave</b> is set to <b>32'–2'</b> : -12.00 – 0.00 – +12.00 semitones            |                              |
|                | Shape        | Waveshape of Oscillator 2 (continuously variable).  | Noise, Saw, Square, Pulse    |
|                | F-Env→Shape  | Amount of Filter Envelope output subtracted from or added to the value defined by the Osc 2 <b>Shape</b> parameter.   | -100 – 0 – +100%             |
|                | Sync         | Enables or disables syncing of Oscillator 2 to Oscillator 1.  | Off, On                      |
|                | Micro Detune | Additional detuning of Oscillator 2.  | 0–100%                       |
| Sub Oscillator | Phase        | Position of the waveshape when the sound is triggered.  | 0–360 degrees                |
|                | Shape        | Waveshape of the sub oscillator (continuously variable).  | Triangle, Saw, Square, Pulse |



**Mixer / Filter**

Use this tab to control EQ for Oscillator 2, set the levels of the oscillators and effects, and edit the low-pass filter.

| <b>Parameter</b> |            | <b>Description</b>  | <b>Value Range</b> |
|------------------|------------|---|--------------------|
| Osc 2 EQ         | Gain       | Amount of gain applied to the selected <b>Frequency</b> .                                   | -48 – 0 – +48 dB   |
|                  | Frequency  | Center frequency for the equalization band.   | 25–10,000 Hz       |
|                  | Drive      | Amount of drive added to the EQ signal.   | 0–100%             |
|                  | Keytrack   | Ties the EQ settings to the pitch being played  | 0–100%             |
| Mixer            | Osc 1      | Level of Oscillator 1.  | 0–100%             |
|                  | Osc 2      | Level of Oscillator 2.  | 0–100%             |
|                  | Sub Osc    | Level of the Sub Oscillator.  | 0–100%             |
|                  | Ring Mod   | Level of Ring Modulation effect.  | 0–100%             |
|                  | Drive      | Level of Drive effect.  | 0–100%             |
| LP Filter        | Cutoff     | Center frequency of the low-pass filter cutoff.   | 0–100%             |
|                  | Reso       | Amount of resonance of the low-pass filter.   | 0–100%             |
|                  | Slope      | Amount of attenuation applied above the cutoff frequency.                                   | 0–24 dB/oct        |
|                  | Saturation | Amount of saturation applied to the low-pass filter.  | 0–100%             |
|                  | Env        | Percentage of the envelope output subtracted from or added to the LP Filter <b>Cutoff</b> . | -100 – 0 – +100%   |
|                  | Keytrack   | Ties the LP Filter Cutoff to the pitch being played.  | 0–100%             |

## Envelope

Use this tab to adjust the various envelope settings.

| Parameter       |             | Description  | Value Range   |
|-----------------|-------------|--|---|
| Filter Envelope | Attack      | Length of time for the filter to reach full level.   | 1.00 ms – 100 s   |
|                 | Decay       | Length of time for the filter to reach sustain level.  | 1.00 ms – 100 s   |
|                 | Sustain     | Length of time for the filter to hold sustain level.   | 0–100%  |
|                 | Release     | Length of time for the filter to dissipate when released.  | 1.00 ms – 100 s   |
| Amp Envelope    | Attack      | Length of time for the note to reach full level.   | 1.00 ms – 100 s   |
|                 | Decay       | Length of time for the note to reach sustain level.  | 1.00 ms – 100 s   |
|                 | Sustain     | Length of time for the note to hold sustain level.   | 0–100%  |
|                 | Release     | Length of time for the note to dissipate when released.  | 1.00 ms – 100 s   |
| Envelope 3      | Start Level | Initial velocity level of the envelope.  | 0–100%  |
|                 | Start Time  | Length of time for the envelope to start.  | 0–5000 ms   |
|                 | Slope Hold  | Percentage of Envelope subtracted from or added to the <b>Destination</b> when a note is held.     | -100 – 0 – +100%  |
|                 | Slope Rel   | Percentage of Envelope subtracted from or added to the <b>Destination</b> when a note is released. | -100 – 0 – +100%  |
|                 | Destination | Where the envelope will be applied to.   | Off, Pitch, Osc 2<br>Pitch, LFO 1/2 Rate,<br>Osc1 Quad Det., Osc<br>1/2 Shape, Osc 1/2<br>Level, Ring Level |

**LFO**

Use this tab to adjust the settings for the low-frequency oscillators.

| Parameter   |             | Description  | Value Range   |
|-------------|-------------|--|---|
| LFO 1/LFO 2 | Shape       | Waveshape of the low-frequency oscillator.   | Sine, Square, Saw Up, Saw Down, Pump, S&H, Drift  |
|             | Destination | Where the low-frequency oscillator is sent.  | <b>LFO1:</b> Off, Pitch, Filter, Level, Pan<br><b>LFO2:</b> Pitch, Osc 1/2 Shape, Osc 1/2 Pitch, LPF, Quad Detune, Osc EQ Freq, Osc 2 EQ Gain, Ring Level |
|             | Rate        | Speed of modulation.   | When <b>Sync</b> is <b>Off</b> : 0.01 – 20.00 Hz<br>When <b>Sync</b> is <b>On</b> : 8/4 – 1/32  |
|             | Depth       | Amount of modulation applied.  | 0–100%  |
|             | Fade        | Apply a fade-in or fade-out of the LFO signal.   | 0.00 – 20.00 s out, No fade, 0.00 – 20.00 s in  |
|             | Sync        | Sync the LFO <b>Rate</b> to the <b>Global Tempo</b> or turn <b>Off</b> to adjust <b>Rate</b> by Hertz. | Off, On   |
|             | Modulation  | Source   | Where the modulation signal is sent from.   |
| Destination |             | Where the modulated signal is received.  | Pitch, Osc 1/2 Shape, Osc 1/2 Pitch, LPF, Quad Detune, Osc EQ Freq, Osc 2 EQ Gain, Ring Level   |
| Depth       |             | Amount of modulation applied.  | 0–100%  |

**Setup**

Use this tab to adjust plugin setup parameters.

| Parameter               | Description  | Value Range   |                            |
|-------------------------|--|---|----------------------------|
| Controller Destinations |  |   |                            |
| Velocity 1              | Send Velocity data to one of the following control destinations.   | Amp, Cutoff, Osc1 Shape, Osc2 Shape, Osc1&2 Shape   |                            |
| Depth                   | Amount of modulation applied.                                      | 0–100%  |                            |
| Velocity 2              | Send Velocity data to one of the following control destinations.   | Amp, Cutoff, Osc1 Shape, Osc2 Shape, Osc1&2 Shape   |                            |
| Depth                   | Amount of modulation applied.                                      | 0–100%  |                            |
| Modwheel                | Send Modwheel data to one of the following control destinations.   | Amp, Cutoff, Osc1 Shape, Osc2 Shape, Osc1&2 Shape   |                            |
| Depth                   | Amount of modulation applied.                                      | -100 – 0 – 100%   |                            |
| Aftertouch              | Send Aftertouch data to one of the following control destinations. | LFO 1 Depth, Cutoff, Osc1 Shape, Osc2 Shape, Osc1&2 Shape                                 |                            |
| Depth                   | Amount of modulation applied.                                      | -100 – 0 – 100%   |                            |
| Setup                   | Polyphony  | Number of allowable voices, and how voices are triggered.                                 | Legato, Retrigger, 2, 3, 4 |
|                         | Bend Range   | Number of semitones up or down controlled by MIDI pitch bend messages.                    | 0–12 (semitones)           |
|                         | Glide Time   | Amount of time to slide from the pitch of one note to the next note played.               | 1.00 ms – 100 s            |
|                         | Glide All  | Enables or disables pitch gliding for all triggered notes, not just legato notes.         | Off, On                    |
|                         | Detune   | Amount of detuning applied. This setting is only applied when <b>Doubling</b> is enabled. | 0–100%                     |
|                         | Doubling   | Enables or disables voice doubling.   | Off, On                    |
| Output                  | Shape  | Amount of signal sent to a Tube Drive.  | 0–100%                     |
|                         | Width  | Stereo width of the audio signal. Higher values give wider stereo separation.             | 0–100%                     |
|                         | Level  | Overall output volume of the plugin.  | -Inf dB – +12.0 dB         |

## Chorus

Use this tab to apply and adjust the settings for the built-in Chorus effect.

| Parameter | Description  | Value Range       |
|-----------|--|-------------------|
| Rate      | Modulation speed of the effect.  | 0.01 – 10.0 Hz    |
| Delay     | Length of time the wet signal is offset from the dry signal.                   | 0.00 – 24.00 ms   |
| Voices    | Number of voices used in the chorus effect.                                    | 3, 4, 6           |
| LFO Wave  | Waveshape of the low-frequency oscillator for the chorus effect.               | Tri, Sine         |
| Depth     | Amount of pitch modulation of the effect.                                      | 0.00 – 24.00 ms   |
| Width     | Stereo width of the chorus effect. Higher values give wider stereo separation. | 0–100%            |
| Lo Cut    | Center frequency for the chorus low-cut filter.                                | 20.0 Hz – 1.0 kHz |
| Mix       | Wet/dry amount of the chorus effect.   | 0–100%            |

## Delay

Use this tab to apply and adjust the settings for the built-in delay effect.

| Parameter | Description  | Value Range        |
|-----------|--|--------------------|
| Time      | Length of time between the dry signal and the delayed signal.<br><br>When <b>Sync</b> is set to <b>Free</b> : 1 ms – 2.00 s<br>When <b>Sync</b> is set to <b>Sync</b> : 1/32 – 8/4 |                    |
| Sync      | Enable to sync the Delay <b>Time</b> to the <b>Global Tempo</b> , disable to set the <b>Time</b> in milliseconds.  | Off, On            |
| Feedback  | Amount of delay signal fed back into the delay line.   | 0–100%             |
| Mix       | Wet/dry amount of the delay effect.  | 0–100%             |
| Damp      | Center frequency of where the delayed signal will be dampened.   | 1.00 – 20.0 kHz    |
| Reso      | Amount of resonance of the feedback signal.  | 0–100%             |
| Reso Freq | Center frequency for feedback resonance.   | 100 Hz – 10.0 kHz  |
| Ratio     | Reduces the delay <b>Time</b> in either the <b>Left</b> or <b>Right</b> stereo field. This is useful for creating offset, panned delays.   | L 100:50, R 50:100 |
| HPF       | Center frequency for delay signal high-pass filter.  | 20.0 Hz – 1.0 kHz  |
| Width     | Stereo width of delay signal. Higher values give wider stereo separation.  | 0–100%             |

**Reverb / Compressor / Hype**

Use this tab to apply and adjust the settings for the built-in Reverb, Compressor and Hype effects.

| Parameter  |           | Description   | Value Range                   |
|------------|-----------|---|-------------------------------|
| Reverb     | Mode      | Type of reverb applied.   | Hall, Stadium, Room, Abstract |
|            | Time      | Length of reverb tail.  | 0.4 s – +Inf s                |
|            | Lo Cut    | Center frequency for the reverb low-pass filter.  | 1 – 1000 Hz                   |
|            | Hi Cut    | Center frequency for the reverb high-pass filter.   | 1.0 – 20.0 kHz                |
|            | Mix       | Wet/dry mix of the reverb effect.   | 0–100%                        |
| Compressor | Threshold | Signal level after which the compressor will be applied.  | 0.0 – -60. dB                 |
|            | Output    | Amount of additional output gain for the compressed signal.   | 0.0 – +30.0 dB                |
|            | Mix       | Wet/dry mix of the compressor effect.   | 0–100%                        |
|            | Ratio     | Amount of compression applied.  | 1.0:1 – 100.0:1               |
|            | Knee      | How gradually the compressor reacts as the threshold is reached.<br><br>Lower values apply a "soft" knee (compression is applied more slowly as signal approaches the threshold), and higher values apply a "hard" knee (compression is immediately applied when the threshold is reached). | 0–100%                        |
|            | Attack    | Length of time to apply the compression.  | 100 us – 300 ms               |
|            | Release   | Length of time for compressed signal to return to original level.   | 10 ms – 4.00 s                |
| Hype       | High      | Dampens or maximizes high end frequencies.  | -100 – 0 – +100%              |
|            | Low       | Dampens or maximizes low end frequencies.   | -100 – 0 – +100%              |

## Plugin Preset Support

Internal Akai effects now include all new plugin editors and factory presets.

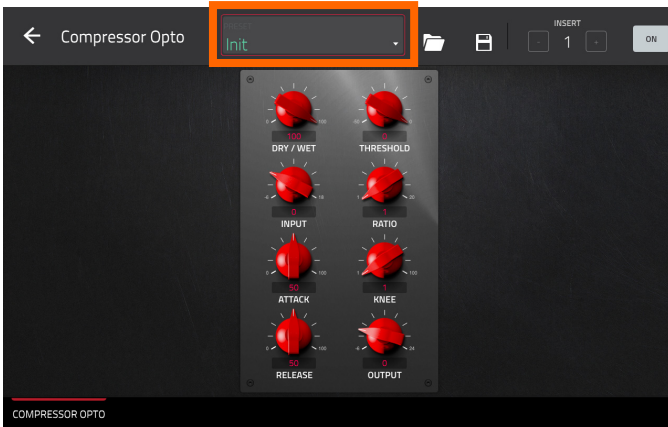

### To load a plugin preset:

1. Open a plugin instrument or effects plugin editor.
2. At the top of the instrument or effect editing window will be a dropdown menu for selecting presets. Double-tap the menu to open it, and tap a preset to select it.

A number of third-party VST plugins will also display a bank of presets when used with MPC.

Additionally, you can now save and load plugin presets.

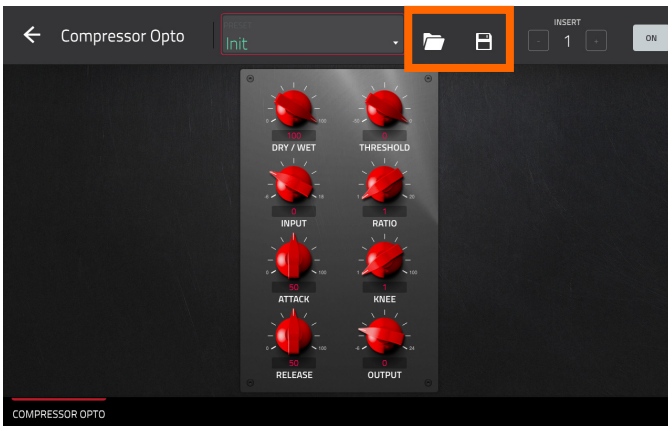

### To save or load a plugin preset:

1. Open a plugin instrument or effects plugin.
2. To the right of the dropdown menu for selecting presets are **Folder** and **Disc** icons.

Tap the **Folder** icon to load a plugin preset saved on your MPC or any connected drive. Use the window that opens to select the location where the preset is saved.

Tap the **Disc** icon to save your plugin settings as a new preset. Use the window that opens to select where you would like to save the preset.

## Updates in MPC 2.4

### New Features

#### AIR FX Bundle

Your MPC now includes the AIR FX Bundle—a collection of 28 effects designed with ease of use in mind with all new touch-interface layouts. These effects include the legendary AIR Creative FX collection that has been used by countless professionals as part of Pro Tools® software since Version 8. They also include 10 new plugins that have been expertly designed by the DSP gurus at AIR Music Technology.

16 classic effects from Pro Tools® now available include the following:

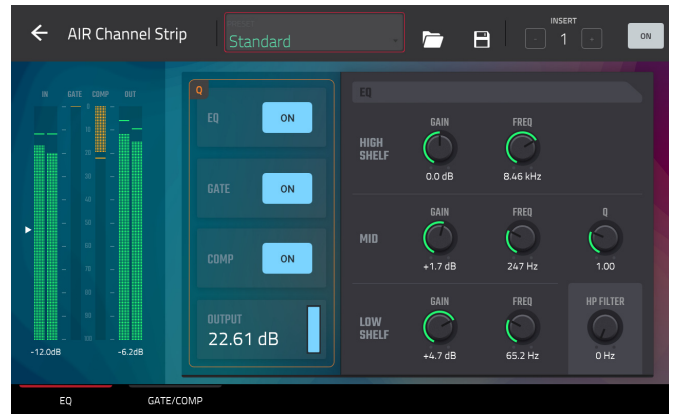

#### AIR Distortion

This effect is a multi-type distortion that adds color to your audio signal with varying types and amounts of distortion.

| Parameter        | Value Range       | Default Value |
|------------------|-------------------|---------------|
| Mode             | Hard, Soft, Wrap  | Hard          |
| Drive            | 0 – 60 dB         | 15 dB         |
| Output           | 0–100%            | 100%          |
| Mix              | 0–100% (dry-wet)  | 100%          |
| Tone Pre-Shape   | -100 – 0 – +100%  | 0%            |
| Tone High Cut    | 1.00 – 20.0 kHz   | 20.0 kHz      |
| Stereo           | On, Off           | Off           |
| Clipping Thresh. | -20.0 – 0.0 dB FS | -10.0 dB FS   |
| Clipping Edge    | 0–100%            | 0%            |

#### AIR Enhancer

This effect enhances the low and high broadband frequencies of the audio signal.

| Parameter  | Value Range                   | Default Value |
|------------|-------------------------------|---------------|
| High Gain  | 0.0 – 12.0 dB                 | 0.0 dB        |
| Low Gain   | 0.0 – 12.0 dB                 | 0.0 dB        |
| Output     | - Inf – 0.0 dB                | 0.0 dB        |
| Freq. High | 1.0 – 10.0 kHz                | 3.16 kHz      |
| Freq. Low  | 40.0 – 640 Hz                 | 160 Hz        |
| Harmonics  | 0.0 – 12.0 dB                 | 0.0 dB        |
| Phase      | + (positive),<br>- (negative) | +             |



**AIR Ensemble**

This effect applies fluid, shimmering modulation effects to the audio signal.

| Parameter    | Value Range      | Default Value |
|--------------|------------------|---------------|
| Rate         | 0.01 – 10.0 Hz   | 1.00 Hz       |
| Depth        | 0.00 – 24.00 ms  | 6.00 ms       |
| Width        | 0–100%           | 100%          |
| Mix          | 0–100% (dry–wet) | 75%           |
| Mod. Delay   | 0.00 – 24.00 ms  | 0.00 ms       |
| Mod. Shimmer | 0–100%           | 50%           |

**AIR Filter Gate**

This effect chops your audio signal into rhythmic patterns with variable filtering, amplitude and panning.

| Parameter     | Value Range  | Default Value |
|---------------|--|---------------|
| Pattern       | Straight, Pulse, Pumper, Marching, Fader, Offbeats, Off+Pan, L/R Pan, LL/RR Pan, Slow Pan, Rand Pan, Shorter, Longer, Reverse, Random, Keyed 1–2, Half Time, 12-Step, Ducked, Trance 1–6, Tech 1–6 | Straight      |
| Rate          | 1/2–1/32, including Dotted and Triplet   | 1/16          |
| Swing         | 50.0–66.7%   | 50.0%         |
| Mix           | 0–100%   | 100%          |
| Filter Mode   | Off, LP, BP, HP, Phaser  | LP            |
| Filter Cutoff | -100 – 0 – 100%  | 0%            |
| Filter Reso   | -100 – 0 – 100%  | 0%            |
| Gate Attack   | 0–100%   | 25%           |
| Gate Hold     | 0–100%   | 50%           |
| Gate Release  | 0–100%   | 25%           |
| Mod LFO Wave  | Random; 2–12, 16, 24, 32, 48, 64, 96, 128, 192, 256 Steps  | Random        |
| Mod Env       | -100 – 0 – 100%  | 0%            |
| Mod LFO       | 0–100%   | 0%            |

**AIR Flanger**

This effect applies a short, modulating delay to the audio signal.

| Parameter | Value Range       | Default Value |
|-----------|-------------------|---------------|
| Rate      | 0.02 – 10.00 Hz   | 0.40 Hz       |
| Depth     | 0–100%            | 50%           |
| Feedback  | 0–100%            | 50%           |
| Mix       | 0–100% (dry–wet)  | 50%           |
| Headroom  | -20.0 – 0.0 dB FS | -10.0 dB FS   |

### AIR Freq Shift

This effect shifts the audio signal's individual frequencies for unique effects.

| Parameter | Value Range                 | Default Value |
|-----------|-----------------------------|---------------|
| Mode      | Up, Down, Up & Down, Stereo | Up            |
| Frequency | 10.0 mHz – 10.0 kHz         | 316 mHz       |
| Feedback  | 0–100%                      | 0%            |
| Mix       | 0–100% (dry–wet)            | 100%          |

### AIR Fuzz Wah

This is a multi-effect that combines transistor-like distortion and wah.

| Tab        | Parameter       | Value Range                 | Default Value |
|------------|-----------------|-----------------------------|---------------|
| Fuzz-Wah   | Mix             | 0–100% (dry–wet)            | 100%          |
|            | Order           | Fuzz>Wah, Wah>Fuzz          | Fuzz>Wah      |
|            | Fuzz Mix        | 0–100% (dry–wet)            | 100%          |
|            | Wah Mix         | 0–100% (dry–wet)            | 100%          |
|            | Fuzz Drive      | 0 – 40 dB                   | 20 dB         |
|            | Fuzz Tone       | 1.00 – 10.0 kHz             | 3.16 kHz      |
|            | Fuzz Output     | -Inf – 0.0 dB               | 0.0 dB        |
|            | Fuzz Enable     | Off, On                     | Off           |
|            | Wah Pedal       | 0–100%                      | 50%           |
|            | Wah Filter Mode | Lowpass, Bandpass, Highpass | Bandpass      |
|            | Min. Freq.      | 50.0 Hz – 4.00 kHz          | 428 Hz        |
|            | Max Freq.       | 50.0 Hz – 4.00 kHz          | 2.07 kHz      |
|            | Min. Resonance  | 0–100%                      | 55%           |
|            | Max Resonance   | 0–100%                      | 33%           |
|            | Wah Enable      | Off, On                     | On            |
| Modulation | Mode            | LFO, Env                    | LFO           |
|            | Rate            |                             |               |
|            | LFO             | 8/4 – 16                    | 4T            |
|            | Env             | 0–100%                      | 75%           |
|            | Depth           | -100 – 0 – 100%             | 0%            |

**AIR Kill EQ**

This effect can zap out the Low, Mid or High broadband frequency from an audio signal.

| Parameter  | Value Range       | Default Value |
|------------|-------------------|---------------|
| High       | Thru, Kill        | Thru          |
| Mid        | Thru, Kill        | Thru          |
| Low        | Thru, Kill        | Thru          |
| Output     | -20.0 – +20.0 dB  | 0.0 dB        |
| High Gain  | -Inf – +12.0 dB   | 0.0 dB        |
| Mid Gain   | -Inf – +12.0 dB   | 0.0 dB        |
| Low Gain   | -Inf – +12.0 dB   | 0.0 dB        |
| High Freq. | 500 Hz – 8.00 kHz | 2.00 kHz      |
| Offset     | -100 – +100%      | 0%            |
| Low Freq.  | 50.0 – 800 Hz     | 200 Hz        |

**AIR Lo-Fi**

This effect is used to bit-crush, down-sample, clip, rectify and mangle an audio signal.

| Tab        | Parameter   | Value Range                                | Default Value |
|------------|-------------|--|---------------|
| Lo-Fi      | Bit Depth   | 1.0 – 16.0 bit                             | 16.0 bit      |
|            | Sample Rate | 500 Hz – 50.0 kHz                          | 50.0 kHz      |
|            | Mix         | 0–100%                                     | 100%          |
| Distortion | Clip        | 0.0 – 40.0 dB                              | 0.0 dB        |
|            | Rectify     | 0–100%                                     | 0%            |
|            | Noise Mod   | 0–100%                                     | 0%            |
| Anti-Alias | Pre         | 0.125 – 2.000 Fs                           | 0.5000 Fs     |
|            | Post        | 0.125 – 2.000 Fs                           | 1.000 Fs      |
|            | Enable      | On, Off                                    | Off           |
| LFO / Env  | Wave        | Sine, Tri, Saw, Square, Morse, S&H, Random | Sine          |
|            | Rate        |  |               |
|            | Sync Off:   | 0.01 – 10.0 Hz                             | 1.00 Hz       |
|            | Sync On:    | 8/4 – 16                                   | 2T            |
|            | Sync        | On, Off                                    | Off           |
|            | Depth       | -100 – 0 – 100%                            | 0%            |
|            | Attack      | 0.1 – 10.0 s                               | 0.5 s         |
|            | Release     | 0.1 – 10.0 s                               | 0.5 s         |
|            | Depth       | -100 – 0 – 100%                            | 0%            |

### AIR Multi-Chorus

This effect applies a thick, complex chorus effect to your audio signal.

| Parameter      | Value Range        | Default Value |
|----------------|--------------------|---------------|
| Rate           | 0.01 – 10.0 Hz     | 1.00 Hz       |
| Depth          | 0.00 – 24.00 ms    | 6.00 ms       |
| Voices         | 3, 4, 6            | 4             |
| Mix            | 0–100% (dry–wet)   | 50%           |
| Chorus Low Cut | 20.0 Hz – 1.00 kHz | 20.0 Hz       |
| Chorus Width   | 0–100%             | 100%          |
| Mod Wave       | Sine, Tri          | Tri           |
| Mod Delay      | 0.00 – 24.00 ms    | 6.0 ms        |

### AIR Non-Lin Reverb

This is a spatial effect, designed to produce synthetic, processed ambience with special gated and reversed reverb effects.

| Parameter | Value Range      | Default Value |
|-----------|------------------|---------------|
| Pre-Delay | 0–250 ms         | 0 ms          |
| Dry Delay | 0–1500 ms        | 0 ms          |
| Time      | 0–1000 ms        | 250 ms        |
| Mix       | 0–100% (dry–wet) | 50%           |
| Diffusion | 0–100%           | 100%          |
| Width     | 0–100%           | 50%           |
| Shape     | Gated, Reverse   | Gated         |
| Low-Cut   | 20.0 Hz–1.00 kHz | 141 Hz        |
| High-Cut  | 1.00–20.0 kHz    | 9.46 kHz      |

### AIR Phaser

This effect applies a phaser to your audio signal, for that wonderful "wooshy," "squishy" sound.

| Parameter    | Value Range                | Default Value |
|--------------|----------------------------|---------------|
| Rate         | 0.10 – 10.00 Hz            | 1.00 Hz       |
| Depth        | 0–100%                     | 50%           |
| Feedback     | 0–100%                     | 0%            |
| Mix          | 0–100% (dry–wet)           | 50%           |
| Phaser Model | Vibe, Stone, Ninety, Tron, | Ninety        |
| Offset       |                            |               |
| Phase        | -180 – +180 deg.           | 0 deg.        |
| Rate         | 25–400%                    | 100%          |
| Type         | Phase, Rate                | Phase         |

### AIR Reverb

This is a spatial effect, with a wide range of reverb types to add space or room to your audio signal.

| Tab     | Parameter         | Values             | Default Value  |      |
|---------|-------------------|--------------------|--|------|
| Reverb  | Pre-Delay         | 0–250 ms           | 0 ms   |      |
|         | Room Size         | 0–100%             | 100%   |      |
|         | Time              | 0.4 ms – +inf s    | 1.9 s  |      |
|         | Mix               | 0–100%             | 50%  |      |
|         | Early Reflection  | Type               | Off, Booth, Club, Room, Small Chamber, Medium Chamber, Large Chamber, Small Studio, Large Studio, Scoring Stage, Philharmonic, Concert Hall, Church, Opera House, Vintage 1, Vintage 2 | Off  |
|         |                   | Length             | 0–100%   | 100% |
|         |                   | ER / Tail Mix      | 0–100%   | 50%  |
|         | Reverb            | Input Width        | 0–100%   | 0%   |
|         |                   | Output Width       | 0–100%   | 0%   |
|         |                   | Delay              | 0–250 ms   | 0 ms |
|         | Room              | Ambience           | 0–100%   | 0%   |
|         |                   | Density            | 0–100%   | 100% |
|         | <b>Hi/Lo Freq</b> |                    |  |      |
| Hi Freq | Time              | -100 – 0 – 100%    | 0%   |      |
|         | Freq              | 2.00 – 20.0 kHz    | 6.32 kHz   |      |
|         | Cut               | 1.0 – 20.0 kHz     | 9.46 kHz   |      |
| Lo Freq | Time              | -100 – 0 – 100%    | 0%   |      |
|         | Freq              | 20.0 Hz – 2.00 kHz | 200 Hz   |      |
|         | Cut               | 1 – 1000 Hz        | 1 Hz   |      |

### AIR Spring Reverb

This is a spatial effect, designed to emulate the sound of a spring reverb tank.

| Parameter | Value Range      | Default Value |
|-----------|------------------|---------------|
| Pre-Delay | 0–250 ms         | 3 ms          |
| Time      | 1.0–10.0 s       | 4.0 s         |
| Mix       | 0–100 (dry–wet)  | 50%           |
| Diffusion | 0–100%           | 100%          |
| Width     | 0–100%           | 0%            |
| Low Cut   | 20.0 Hz –1.0 kHz | 141 Hz        |

**AIR Stereo Width**

This effect creates a wider stereo presence in an audio signal.

| Parameter  | Value Range           | Default Value |
|------------|-----------------------|---------------|
| Width      | 0–200%                | 100%          |
| Delay      | 0.0 – 8.0 ms          | 0.0 ms        |
| Level Trim | -Inf – 0.0 – +12.0 dB | 0.0 dB        |
| Pan Trim   | L100 – <C> – R100     | <C>           |
| High       | 0–200%                | 100%          |
| Mid        | 0–200%                | 100%          |
| Low        | 0–200%                | 100%          |

**AIR Talk Box**

This effect adds voice-like resonances to audio signals.

| Parameter   | Value Range  | Default Value |
|-------------|--|---------------|
| Vowel       | OO, OU, AU, AH,<br>AA, AE, EA, EE, EH,<br>ER, UH, OH, OO | AH            |
| Env Depth   | -100 – 0 – +100%   | 0%            |
| Formant     | -12.00 – +12.00  | 0.00          |
| Mix         | 0–100%   | 100%          |
| LFO Wave    | Sine, Tri, Saw,<br>Square, S&H,<br>Random                | Sine          |
| LFO Rate    |  |               |
| Sync Off:   | 0.01 – 10.0 Hz   | 1.00 Hz       |
| Sync On:    | 8/4 – 16   | 2T            |
| LFO Sync    | Off, On  | Off           |
| LFO Depth   | -100 – 0 – +100%   | 0%            |
| Env Thresh  | -60.0 – 0.0 dB   | -30.0 dB      |
| Env Attack  | 0.1 – 10.0 s   | 0.5 s         |
| Env Release | 0.1 – 10.0 s   | 0.5 s         |

12 all new plugins from AIR include the following:

### AIR Channel Strip

This specially-designed plugin combines multiple effects with a fast interface. The EQ section provides a highpass filter, low and high shelves, and a fully parametric mid-band. For dynamics, the AIR Compressor and Gate algorithms are perfect for achieving hard-hitting drum sounds.

| Tab       | Parameter       | Value Range        | Default Value |
|-----------|-----------------|--------------------|---------------|
|           | EQ Enable       | Enabled, Bypass    | Enabled       |
|           | Gate Enable     | Enabled, Bypass    | Enabled       |
|           | Comp Enable     | Enabled, Bypass    | Enabled       |
|           | Output          | -Inf – +24.00 dB   | 0.00 dB       |
| EQ        | High Shelf Gain | -12.0 – +12.0 dB   | 0.0 dB        |
|           | High Shelf Freq | 1.20 – 20.0 kHz    | 6.00 kHz      |
|           | Mid Gain        | -18.0 – +18.0 dB   | 0.0 dB        |
|           | Mid Freq        | 40.0 Hz – 16.0 kHz | 247 Hz        |
|           | Mid Q           | 0.40 – 10.00       | 1.00          |
|           | Low Shelf Gain  | -12.0 – +12.0 dB   | 0.0 dB        |
|           | Low Shelf Freq  | 20.0 Hz – 1.00 kHz | 100 Hz        |
|           | HP Filter       | 0 – 1000 Hz        | 0 Hz          |
| Gate/Comp | Gate Thresh     | -120.0 – 0.0 dB    | -120.0 dB     |
|           | Gate Depth      | 0 – -120.0 dB      | -120.0 dB     |
|           | Gate Attack     | 0.01 – 1000.00 ms  | 0.18 ms       |
|           | Gate Release    | 1.00 – 3000.00 ms  | 7.40 ms       |
|           | Comp Thresh     | 0.0 – -60.0 dB     | 0.0 dB        |
|           | Comp Ratio      | 1.0:1 – 100.0:1    | 3.9:1         |
|           | Comp Attack     | 100 us – 300 ms    | 5.48 ms       |
|           | Comp Release    | 10.0 ms – 4.00 s   | 200 ms        |

### AIR Compressor

This basic compressor effect changes the dynamic range of a signal by automatically reducing its gain if it exceeds a certain level (the threshold).

| Parameter | Value Range      | Default Value |
|-----------|------------------|---------------|
| Threshold | -60.0 – 0 dB     | -48.0 dB      |
| Ratio     | 1.0:1 – 100.0:1  | 3.9:1         |
| Output    | 0.0 – 30.0 dB    | 15.0 dB       |
| Mix       | 0–100% (dry-wet) | 100%          |
| Knee      | 0–100%           | 50%           |
| Attack    | 100 us – 300 ms  | 5.48 ms       |
| Release   | 10.0 ms – 4.00 s | 200 ms        |

**AIR Delay**

This is a classic delay line effect with a variable feedback filter. Additional Ratio and Width parameters enable you to achieve a wide range of stereo delay effects.

| Parameter       | Value Range       | Default Value |
|-----------------|-------------------|---------------|
| Time            |                   |               |
| Sync Off        | 1 ms – 2.00 s     | 388 ms        |
| Sync On         | 1/32 – 8/4        | 1/8D          |
| Sync            | Off, On           | Off           |
| Feedback        | 0–100%            | 40%           |
| Mix             | 0–100% (dry–wet)  | 50%           |
| Delay Ratio     | 50:100 – 100:50   | 100:100       |
| Delay HPF       | 20.0 Hz – 1.0 kHz | 20.0 Hz       |
| Delay Width     | 0–100%            | 100%          |
| Feedback Damp   | 1.0 – 20.0 kHz    | 20.0 kHz      |
| Feedback Reso   | 0–100%            | 0%            |
| Fdbk. Reso Freq | 100 Hz – 10.0 kHz | 1.0 kHz       |

**AIR Diff Delay**

This is a delay line effect that is synchronized to your session tempo and uses an adjustable amount of diffusion to emulate the dissipation of echoes in reverberant space.

| Parameter       | Value Range   | Default Value |
|-----------------|---|---------------|
| Time            |   |               |
| Sync Off:       | 1 – 1000 ms   | 161 ms        |
| Sync On:        | 1/64 – 4/4<br>(including Triplet<br>and Dotted<br>variations) | 1/16D         |
| Sync            | Off, On   | On            |
| Width           | 0–100%  | 100%          |
| Mix             | 0–100% (dry–wet)  | 40%           |
| Feedback        | 0–100%  | 50%           |
| Fdbk. Diffusion | 0–100%  | 40%           |
| Fdbk. High Damp | 0–100%  | 35%           |
| Low Cut         | 20.0 Hz – 1.00<br>kHz   | 20.0 Hz       |
| Pan             | -100 – 0 – +100%  | 0%            |



**AIR Filter**

This effect applies a filter to the audio signal and then applies selectable saturation or reduction to the filtered signal.

| Parameter        | Value Range   | Default Value |
|------------------|---|---------------|
| Cutoff Freq      | 55.0 Hz – 20.0 kHz  | 20.0 kHz      |
| Reso Factor      | 0.7 – 20.0  | 1.0           |
| Type             | LP4-1, BP2, BP4, HP2_LP1, HP3_LP1, HP4-1, BR2, BR4, BR2_LP1, BR2_LP2, HP1_BR2, BP2_BR2, HP1_LP2, HP1_LP3, AP3, AP3_LP1, HP1_AP3 | LP4           |
| Output Gain      | -Inf dB – 0.0 dB  | 0.0 dB        |
| Saturation Type  | Resample, Bit Crush, Rectify, Hard Clip, Distort, Overdrive   | Overdrive     |
| Saturation Drive | 0.0 – 12.0 dB   | 0.0 dB        |
| Saturation Mode  | DCF, CVF  | DCF           |

**AIR Maximizer**

This effect is a limiter optimized for professional mastering.

| Parameter  | Value Range        | Default Value |
|------------|--------------------|---------------|
| Threshold  | -40.0 – 0.0 dB     | -20.0 dB      |
| Ceiling    | -20.0 – 0.0 dB FS  | -5.0 dB FS    |
| Look Ahead | 0.0 – 20.0 ms      | 0.0 ms        |
| Knee       | Hard, Soft         | Hard          |
| Release    | 10.0 ms – 10.0 s   | 316 ms        |
| LF Mono    | 10.0 Hz – 1.00 kHz | 10.0 Hz       |

**AIR Noise Gate**

This effect is similar to a compressor, but instead of attenuating audio signal that rises above a threshold, a noise gate attenuates audio signal that falls below a threshold by a set amount. This can help reduce background noise in your audio signal.

| Parameter      | Value Range       | Default Value |
|----------------|-------------------|---------------|
| Threshold      | -120.0 – 0.0 dB   | -48.0 dB      |
| Depth          | 0 dB – -120.0 dB  | -120 dB       |
| Denoise Filter | Off, On           | Off           |
| Denoise Thresh | -120.0 – 0.0 dB   | -60.0 dB      |
| Attack         | 0.01 – 1000.00 ms | 0.18 ms       |
| Hold           | 0 – 1000 ms       | 250 ms        |
| Release        | 1.00 – 3000.00 ms | 7.40 ms       |

**AIR Para EQ**

This effect is a powerful four-band parametric equalizer with four independent EQ ranges, adjustable Low and High EQ filter types, and dedicated Low Cut and High Cut.

| <b>Parameter</b> | <b>Value Range</b>  | <b>Default Value</b> |
|------------------|---------------------|----------------------|
| High Freq        | 1.2 – 20.0 kHz      | 6.00 kHz             |
| High Q           |                     |                      |
| Shelf            | 0.40 – 2.00         | 1.00                 |
| Bell             | 0.40 – 10.00        | 1.00                 |
| High Gain        |                     |                      |
| Shelf            | -12.0 – +12.0 dB    | 0.0 dB               |
| Bell             | -18.0 – 18.0 dB     | 0.0 dB               |
| High Type        | Shelf, Bell         | Shelf                |
| High Out/In      | Out, In             |                      |
| High Mid Freq    | 120 Hz – 16.0 kHz   | 2.00 kHz             |
| High Mid Q       | 0.40 – 10.00        | 1.00                 |
| High Mid Gain    | -18.0 – 18.0 dB     | 0.0 dB               |
| High Mid Out/In  | Out, In             |                      |
| Low Mid Freq     | 40.0 Hz – 16.00 kHz | 247 Hz               |
| Low Mid Q        | 0.40 – 10.00        | 1.00                 |
| Low Mid Gain     | -18.0 – 18.0 dB     | 0.0 dB               |
| Low Mid Out/In   | Out, In             |                      |
| Low Freq         | 20.0 Hz – 1.00 kHz  | 100 Hz               |
| Low Q            |                     |                      |
| Shelf            | 0.40 – 2.00         | 1.00                 |
| Bell             | 0.40 – 10.00        | 1.00                 |
| Low Gain         |                     |                      |
| Shelf            | -12.0 – +12.0 dB    | 0.0 dB               |
| Bell             | -18.0 – 18.0 dB     | 0.0 dB               |
| Low Type         | Shelf, Bell         | Shelf                |
| Low Out/In       | Out, In             |                      |
| Output           | -20.0 – +20.0 dB    | 0.0 dB               |
| High Cut Freq    | 120 Hz – 20.0 kHz   | 20.0 kHz             |
| High Cut Type    | 6, 12, 18, 24 dB    | 12 dB                |
| High Cut Out/In  | Out, In             |                      |
| Low Cut Freq     | 20.0 Hz – 8.00 kHz  | 100 Hz               |
| Low Cut Type     | 6, 12, 18, 24 dB    | 12 dB                |
| Low Cut Out/In   | Out, In             |                      |

### AIR Pitch Shifter

This effect alters the pitch of the audio signal and can be adjusted based on the source or style of the signal.

| Parameter | Value Range                          | Default Value |
|-----------|--------------------------------------|---------------|
| Mode      | Vocal, Bass, Beats, Chords, Textures | Vocal         |
| Shift     | -24.0 – 0 – 24.0                     | 0.0           |
| Mix       | 0–100%                               | 100%          |

### AIR Pumper

This effect creates a rhythmic pumping effect, similar to that of sidechain compression.

| Parameter      | Value Range        | Default Value |
|----------------|--------------------|---------------|
| Depth          | 0–100%             | 80%           |
| Speed          | Bar, 1/2 – 1/32T   | 1/4           |
| Release Shape  | 0–100%             | 10%           |
| Trigger Offset | -100.0 – +100.0 ms | 0.0 ms        |
| Attack         | 0–100%             | 5%            |
| Hold           | 0–100%             | 10%           |
| Release        | 0–100%             | 60%           |

### AIR Transient

This effect is used to enhance or soften the Attack and Release phases of audio material.

| Parameter    | Value Range      | Default Value |
|--------------|------------------|---------------|
| Attack       | -100 – 0 – +100% | 0%            |
| Attack Shape | 0–100%           | 50%           |
| Sustain      | -100 – 0 – +100% | 0%            |
| Output       | -20.0 – +20.0 dB | 0.0 dB        |
| Limit        | Off, On          | On            |

### AIR Tube Drive

This effect is designed to reproduce the sound of an overdriven tube amplifier.

| Parameter  | Value Range      | Default Value |
|------------|------------------|---------------|
| Drive      | 0–100%           | 0%            |
| Headroom   | -30.0 – 0.0 dB   | -15.0 dB      |
| Saturation | 0–100%           | 50%           |
| Output     | -20.0 – +20.0 dB | 0.0 dB        |

### AIR Instrument Layouts

MPC now contains stunning new touch-interface layouts for the following AIR Music Technology instrument plugins: **Hybrid**, **Loom**, **Vacuum Pro**, **Velvet**, **Xpand!2** and **theRiser**.

## Clip Program Improvements

Internal Clip Program architecture has been significantly improved, allowing you to play up to 16 clip programs at the same time. Clips will continue to play when changing tracks or sequences, allowing you to seamlessly integrate them into live performance.

## FLAC and OGG Support

You can now load and export FLAC and OGG files with MPC.

## Mother Ducker

You can now apply sidechain ducking effects in MPC using the new **Mother Ducker** and **Mother Ducker Input** insert effects.

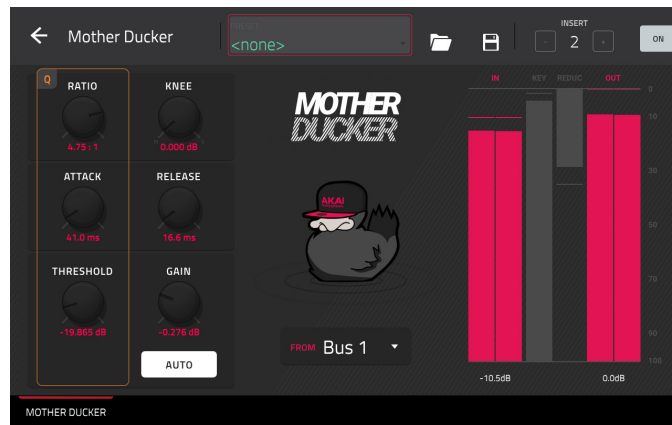

### Mother Ducker

Add this effect as an insert to the track you want to have the ducking effect applied to. Use the meters to monitor the level from your trigger input and tweak the Threshold and Ratio parameters to adjust the amount of ducking. The Attack and Release parameters can be used to sculpt the envelope of the gain reduction to achieve exactly the pumping effect you are after. Mother Ducker has eight internal buses so you can set up multiple channel strips with ducking effects from different sources.

| Parameter | Value Range           | Default Value |
|-----------|-----------------------|---------------|
| Ratio     | 1.00:1 – 60.00:1      | 6.00:1        |
| Knee      | 0.000 – 6.000 dB      | 0.000 dB      |
| Attack    | 1.0 – 1000.0 ms       | 10.0 ms       |
| Release   | 1.0 – 1000.0 ms       | 100.0 ms      |
| Threshold | -100.000 – 0.000 dB   | -6.021 dB     |
| Gain      | -100.000 – +12.000 dB | -0.000 dB     |
| Auto Gain | On, Off               | On            |
| From      | Bus 1–8               | Bus 1         |

### Mother Ducker Input

Add this effect as an insert to the track you want to use as a trigger input, such as a kick drum track.

| Parameter | Value Range | Default Value |
|-----------|-------------|---------------|
| To        | Bus 1–8     | Bus 1         |

## Next Sequence Mode

Next Sequence Mode now remembers the next sequence change when switching to another mode.

## Additional Transport Controls

You can now hold **Shift** and press **Stop** to return the playhead to the beginning of the timeline.

## Updates in MPC 2.5

### New Features

#### Splice Integration

Your standalone MPC hardware now integrates with the Splice platform, allowing you to download and browse your Splice sample library on your standalone device.

##### To access Splice:

1. First, make sure your MPC hardware is connected to a Wi-Fi network. See [Preferences > Wi-Fi](#) to learn how to connect to a wireless network. You will also need access to a web browser.
2. On your MPC, press **Menu** and tap the **gear icon** at the top of the screen to open the **Preferences** page.
3. Navigate to the **Splice** tab.
4. Tap the **Get Login Code** button. (If you are not connected to a network, you will be prompted to do so before the Get Login Code button appears.)
5. Follow the on-screen instructions to link your MPC to your Splice account via a web browser. It may take your MPC a few moments to successfully link.
6. A message will appear on screen when the link has been successfully established. Tap **OK** to continue and return to the Splice Preferences page.
7. Once the process is complete and your MPC has been paired to your Splice account, tap the **Sync Files** button to download samples from your Splice account via Wi-Fi to a drive of your choice.

By default, files will be stored on the Internal drive. You can change the selected drive by tapping the **Change** button under **Sync Files To Drive**.

##### To browse samples imported from Splice:

1. Open the **Browser**.
2. Under the **Content** tab, tap the **Splice** shortcut icon to view samples downloaded from your Splice account.  
If nothing appears, make sure that you have connected your Splice account and synced your files by following the directions [above](#).
3. The right-side of the browser will display your Splice samples organized into a series of top level folders, allowing you to easily browse your sample library by BPM, Instrument, Key, Pack or Tag. The **All Your Samples** folder will show a list of all samples you have downloaded.

**Note:** The original sample files are stored in the **By Pack** folder on your drive. Other folders such as By Instrument contain internal links to help sort the samples by various tags. If the By Pack folder on your drive is deleted, the files in the remaining folders will become unusable. To fully remove all files, the entire Splice directory should be deleted.

**IMPORTANT:** Drives formatted using the FAT32 system do not support these internal links. For these drives, and on the internal storage drives of some earlier MPCs, samples will only be sorted in the **By Pack** folder. We recommend using an exFAT file system on external drives used with MPC, as it is the most robust one supported by both Windows and macOS.

**To view the number of samples available to download from your account,** tap the **Check For Update** button.

**To log out of a Splice account,** tap the **Log Out** button.

## Browser Audition Warp and Sync

In the Browser, you can now audition samples that have an MPC-embedded tempo in sync with the project tempo.

1. Open the Browser by doing either of the following:
  - Press **Menu** and then tap **Browser**.
  - Press **Browse** (MPC X) or **Shift+Menu/Browse** (MPC Live, MPC Touch)
2. Tap **Audition** at the bottom of the screen, or press the respective F-Key (MPC X only).
3. In the options that appear, enable **Sync** to set samples to be auditioned at the beginning of the next bar of the sequence when playback is active.

Enable **Warp** to set samples with an embedded tempo to be warped to the project tempo. Samples with no embedded tempo or externally-embedded tempo will not be affected by this setting.

4. Select a sample, loop, program or project to preview, then tap the **Play** button to audition. If **Auto** Audition is turned on, samples will audition when selected.

## Updates in MPC 2.6

### New Features

#### Ableton Live Set Export

You can now export MPC sequences as an Ableton Live Set (.ALS) file.

##### To export the current sequence as an Ableton Live Set:

1. Open **Main Mode** by pressing **Main**, or by pressing **Menu** and then tapping **Main**.
2. Tap the **Project** field at the top of the display to open the Project window.
3. Tap **ALS Export**.
4. In the window that appears, you can adjust the following settings for your export:

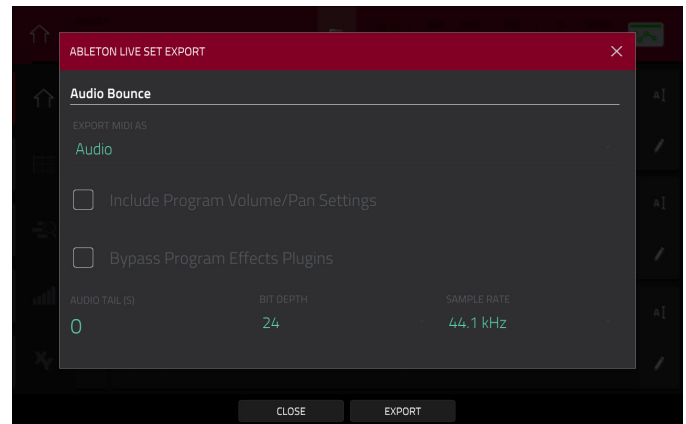

Use the **Export MIDI As** settings to choose how MIDI programs and sequences are exported, either as **Audio** files or **MIDI** files. When using Plugin, Drum or Keygroup programs, you can render sequences as **Audio** to preserve the sound of the instruments, or render sequences as **MIDI** data.

Check the **Include Program Volume/Pan Settings** box to include these settings in the export. When disabled, the volume and pan settings will be set to **0 dB** and center (**C**), respectively.

Check the **Bypass Program Effects Plugins** box to deactivate any third-party effect plugins used with the program for the export. When disabled, those effects will be activated.

Use the **Audio Tail** field to set the amount, in **seconds**, of extra time added to the end of the resulting audio files.

Use the **Bit Depth** field to set the bit depth to **8**, **16** or **24**.

Use the **Sample Rate** field to set the sample rate to **44.1**, **48**, **88.2** or **96 kHz**. In most cases, we recommend selecting **44.1 kHz**.

5. Tap **Export** to begin the export, or tap **Close** to cancel and return to the previous page.

#### Erase Parameters

From the Erase window, you can now erase selected automation parameters.

1. While the sequence is stopped, press the **Erase** button to open the Erase window.
2. Tap **Automation** to select it.
3. By default, the **Parameter** field is set to **All**. Double-tap this field to display a list of all parameters that have been automated on the current track.
4. Select the parameter you would like to erase, and then tap **Do It** to erase the automation.

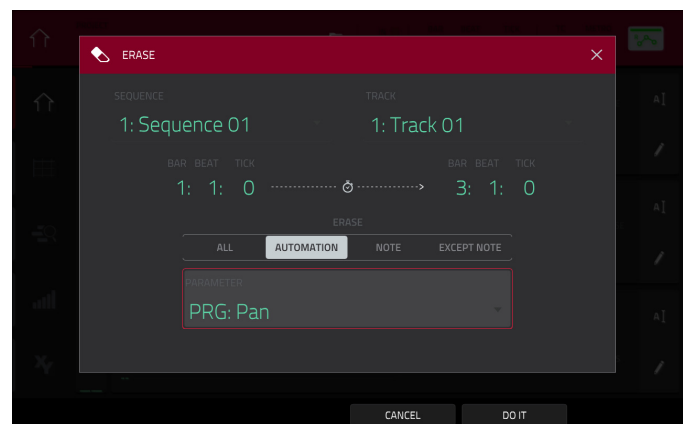



## Grid Automation Lanes

You can now input, view and edit automation in Grid View and Audio Edit Mode.

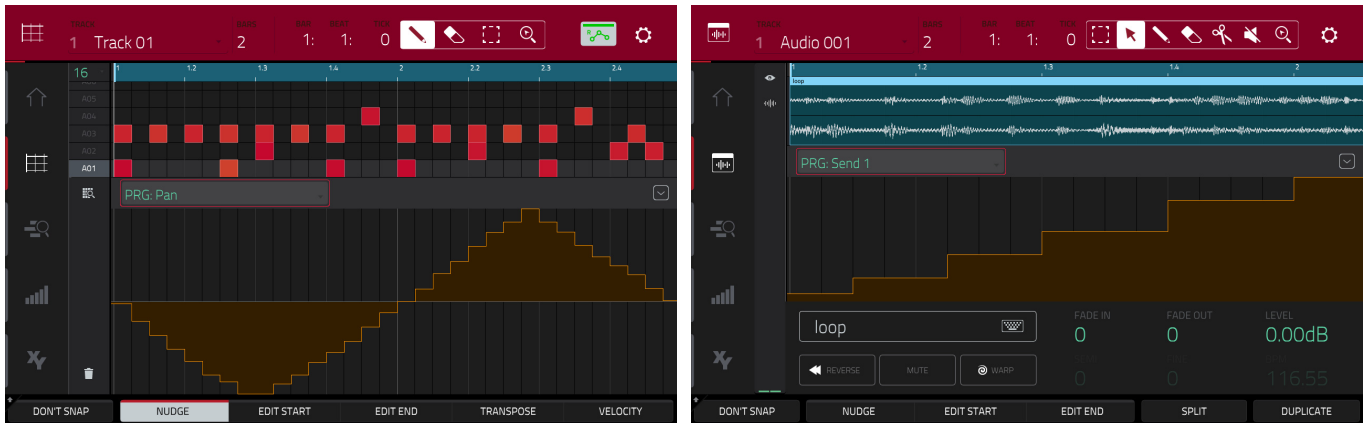

### To add automation to a sequence:

1. Select a **MIDI program** or **Audio program**.
2. For MIDI programs, tap the **grid icon** to open **Grid View**. For Audio programs, tap the **waveform-and-box icon** to open **Audio Edit Mode**.
3. Tap the **up arrow** on the parameter bar to expand the velocity/automation lane.
4. By default, **Velocity** is shown in this lane for MIDI programs and **PRG: Volume** is shown for Audio programs. Double-tap this field to open the **Parameter** drop-down menu.
5. In the menu that appears, tap **Add New** to add an automation parameter. You can choose from a variety of parameters depending on the type of program, insert effects added and other options.

### To edit automation, do any of the following in Grid View or Audio Edit View:

- Use the **pencil** tool to draw your automation in the automation lane.
- Use the **eraser** tool to erase automation points. If you erase all automation points, the parameter will be removed.
- Tap the **trash can icon** to delete all automation for the selected parameter at once (Grid View only).

You can also edit automation using the **Step Sequencer** (see [below](#)).

## Step Automation

You can now input, view and edit automation in the Step Sequencer.



### To add a step automation parameter:

1. Open the Step Sequencer by doing either of the following:
  - Press **Menu**, and then tap **Step Sequencer**.
  - Press **Step Seq** (MPC X).
2. By default, the **Parameter** field of the Step Sequencer displays **Velocity** for MIDI programs and **PRG: Volume** for audio programs. Double-tap this field to open the drop-down menu.
3. In the menu that appears, tap **Add New** to add an automation parameter. You can choose from a variety of parameters depending on the type of program, insert effects added and other options.

### To edit step automation, do any of the following:

- Tap and drag your finger in the step area to freely draw step values.
- Press and hold the **Q-Link** button, and then tap **Screen** to set the Q-Link knobs to Screen Mode. While viewing the step sequencer, you can use the Q-Link knobs for tactile control of each step's automation value, emulating traditional knob-based step sequencers. While it is being adjusted, the current automation value will be shown next to the **Parameter** field, as well as in the display strip above the knobs (MPC X only).

For MPC Live and MPC Touch, use **Bank 1** of the knobs to control **Steps 1–4**, **Bank 2** to control **Steps 5–8**, **Bank 3** to control **Steps 9–12** and **Bank 2** to control **Steps 13–16**.

- Press and hold **Shift** and tap **Clear** to clear all automation for the selected parameter in the selected sequence.
- Press and hold **Shift** and tap **Clear Bar** to clear all automation for the selected parameter in the current bar of the selected sequence.
- Use the **Nudge** < and > buttons to shift the current automation parameter to the left or right at the current Timing Correct value.
- Use the **slider** on the right edge of the screen to increase or decrease the parameter values of all automation steps in the visible time range.
- Tap **Presets** and use the buttons to apply the presets to the step automation (See [Operation > Modes > Step Sequencer](#) for more information).

**Note:** When editing step automation, if a step is not activated, a darkened step bar will indicate the current parameter value at that step, based on the last active step.

## Submixes

MPC hardware now contains 8 submixes in Standalone Mode for additional track and program routing options.

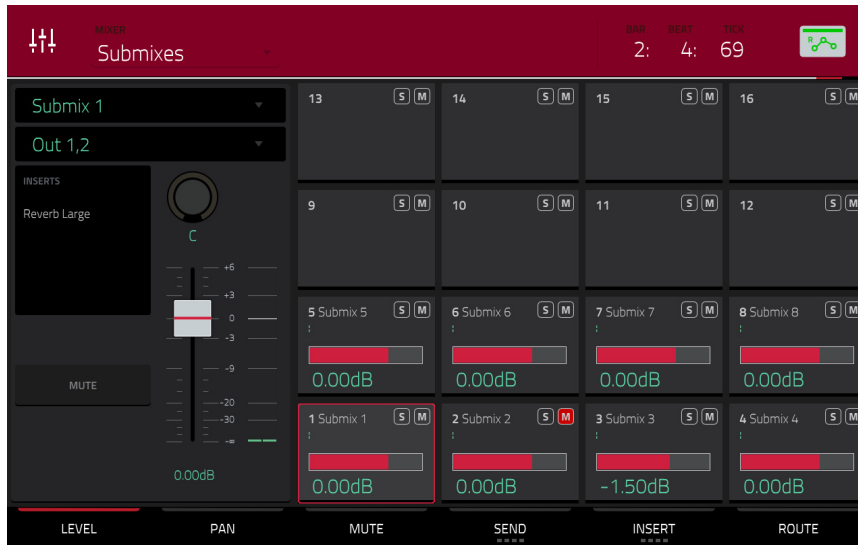

### To assign an audio track or program to a submix:

1. Press **Menu**, and then tap **Channel Mixer**. Alternatively, press **Ch. Mixer** (MPC X only).
2. Set the **Mixer** field at the top of the display to **Audio Tracks** or **Programs**.
3. Double-tap the **Output** field of the audio track or program channel strip.
4. In the drop-down menu, scroll to the top of the list and tap to select **Sub 1–8**. The audio track or program's audio will now be routed to the selected submix.

### To edit a submix:

1. Press **Menu**, and then tap **Channel Mixer**. Alternatively, press **Ch. Mixer** (MPC X only).
2. Set the **Mixer** field at the top of the screen to **Submixes**.
3. Use the **mixer grid** to select a submix, and then use the channel strip on the left side of the screen to add effects or adjust level, pan and other parameters.

## Workflow Enhancements

The **Keep or Discard** window in Sample Record Mode and the **Export Loop as Sample** window in Looper Mode now have easy-access buttons to **Save** or **Edit** the recorded sample or loop.

In Sequence Edit Mode, you can now copy events from individual or multiple pads or notes from the **Copy Events** window.

In the **Sequence Edit > Copy Sequence** and **Track Edit > Copy Track** windows, you can now rename the destination sequence or track.

The FX list can now be sorted by type of effect for easier navigation.

Timing Correct can now be applied to all tracks by pressing the **All Track** button in the Timing Correct window.

## Updates in MPC 2.7

### New Features

#### Ableton Live Control

Your standalone MPC X and MPC Live are now pre-mapped to control Ableton Live 10.1.2 or later for instant performance and production setup, providing an unparalleled level of integration with Ableton Live from a standalone device. MPC's Live Control Mode has been carefully designed to allow you to instantly switch between using MPC in standalone mode and Live Control mode without ever stopping playback. You can control Ableton Live over a Wi-Fi network for cableless operation, or connect standalone MPC X or MPC Live to your computer using a USB-to-Ethernet adapter for a more tightly controlled setup.

**To get started with Ableton Live Control**, you will need to follow the directions in the sections below download, install and configure the necessary software.

#### Akai Network Driver

The Akai Network Driver will allow your MPC X or MPC Live to seamlessly communicate with and control Ableton Live.

1. Download the Akai Network Driver from [akaipro.com](http://akaipro.com) and install it by following the directions.
2. Once the installation has completed, restart your computer.
3. Power on your MPC.
4. Press **Menu** and tap the **gear icon** to open the **Preferences** menu.
5. Tap **Wi-Fi** to open the Wi-Fi settings. Make sure Wi-Fi is set to **On**, and then connect to your local wireless network.

Alternatively, you can connect MPC to your network using a USB-to-Ethernet adapter. In this case, select **Ethernet** from the **Preferences** menu and make sure the **Enabled** option is checked.

6. Open the **Akai Network Driver** application.
7. In the **Configured Remote Device** field, locate the IP address and Serial Number of your MPC and select it. If you need to verify you are selecting the correct unit, you can view network information on your MPC in the **Wi-Fi** menu by holding **Shift** and tapping **Info**.
8. If you still do not see your unit's Serial Number and IP, click the **Add a Device** button to manually enter your unit's IP address.
9. Once your unit has been successfully configured, you can rename it by pressing the **Rename a Selected Device** button. When you are finished, you can close the Akai Network Driver application and open Ableton Live.

#### Configuring Ableton Live

1. **Important:** To use MPC v2.7 to control Ableton Live, you will need to download and install version 10.1.2 or later.
2. Open Ableton Live 10.1.2 or later.
3. Open the **Preferences** menu by selecting **Live > Preferences**.
4. Make sure you have selected your preferred **Audio Device** in the **Audio** tab.
5. In the **Link / MIDI** tab, click the first available **Control Surface** field and select **Akai Force MPC**.
6. In the same row, select **Akai Network – DAW Control** as the **Input** and **Output**.
7. Under the **MIDI Ports** section, set **Remote** for the **Akai\_Force\_MPC Input** and **Akai\_Force\_MPC Output** to **On**.

Once the previous steps have been completed, you can begin controlling Ableton Live with your MPC.

## Live Control Mode

**To open Live Control mode**, press **Menu** (or tap the icon in the upper-left corner of the screen) on your standalone MPC hardware and then tap **Live Control**.

Alternatively, press and hold the **Menu** button and then tap **Pad 4** to jump to Live Control mode.

**To exit Live Control mode**, press **Menu** (or tap the icon in the upper-left corner of the screen) on your standalone MPC hardware and then select another mode.

Alternatively, press and hold the **Menu** button and then tap a pad to jump to another mode.

Live Control Mode consists of three main views, which can be selected by tapping the tabs on the left side of the display: **Matrix View**, **Mixer View** and **Device Control View**. Click the links to jump to that section.

In each of these modes, you will always have access to the following controls and functions on the display:

Tap a track name to select it.

Tap the **stop icons** at the bottom of the display to stop clips in the selected track.

Tap the **Launch Quantize** field (above the scene launch arrows) to set the **Launch Quantize** value.

Tap the **Scene Launch arrows** on the right side of the display to launch all clips in that row.

Additionally, MPC's hardware controls are pre-mapped to give you hands-on control of parameters and functions. See the **MPC X Control Map** and **MPC Live Control Map** for the complete mappings.

## Control Bar

At the top of the interface is the **Control Bar**. This toolbar can be configured to one of three presets based on typical Ableton Live use cases in the **Settings** window.

**To open the Settings window**, tap the **gear icon** in the top-right corner of the display.

Use the **Control Bar** field to select one of the three preset configurations: **Settings**, **Arrangement** or **Performance**.

- **Session:** The Session View configuration is ideal for working in Ableton Live's 8x8 clip launch matrix.
  - Use the **BPM** field to adjust the tempo in Ableton Live.
  - Tap the **Phase Nudge Down** and **Phase Nudge Up** icons to temporarily decrease or increase the tempo in Ableton Live.
  - Tap the **metronome icon** to enable to disable the metronome in Ableton Live.
  - Tap the **follow icon** to turn following on or off. When set to on, your Ableton Live software display will move along with playback to keep the current playback position in view. You can adjust the **Follow Behavior** in Ableton Live's Preferences.
  - Use the **Position** field to select the playback position.
  - Tap the **+ icon** to enable or disable MIDI Arrangement Overdubbing.
  - Tap the **automation icon** to enable to disable automation recording.
- **Arrangement:** The Arrangement configuration is ideal for working with Ableton Live's linear Arrangement view.
  - Use the **BPM** field to adjust the tempo in Ableton Live.
  - Use the **Position** field to select the playback position.
  - Use the **Start** field to select the Arrangement loop start point.
  - Tap the **loop icon** to enable or disable Arrangement looping.
  - Use the **Length** field to select the Arrangement loop length.
- **Performance:** The Performance configuration is ideal for real-time performance with Ableton Live.
  - Use the **BPM** field to adjust the tempo in Ableton Live.
  - Tap the **Phase Nudge Down** and **Phase Nudge Up** icons to temporarily decrease or increase the tempo in Ableton Live.

Use the **Quantize To** field to set the time division for quantization: **1/4**, **1/8**, **1/8T**, **1/8 and 1/8T**, **1/16**, **1/16T**, **1/16 and 1/16T** or **1/32**.

## Matrix View

The Matrix View provides an overview of the clip matrix from Ableton Live's Session view, displaying up to eight tracks and eight rows of clips on the display. The tracks and clips displayed on your MPC's touchscreen will be shown in Ableton Live with a colored box outline.

Your MPC's pads control up to four tracks and four rows of clips, marked by a white outline on the display.

**To move the 4x4 Session Matrix focus one row or column at a time:**

**MPC X:** Use the **cursor buttons**.

**MPC Live:** Use the **Bank buttons**.

**To move the 4x4 Session Matrix focus by eight rows or eight columns at a time:**

**MPC X:** Hold **Shift** and use the **cursor buttons**.

**MPC Live:** Hold **Shift** and use the **Bank buttons**.

**To launch a clip from the 4x4 Session Matrix,** press the corresponding pad on your MPC X or MPC Live.

You can also use the pads to launch scenes.

**To toggle between launching clips and scenes:**

**MPC X:** Press the **XYFX** button.

**MPC Live:** Press the **16 Level** button.

**To launch a scene,** press a pad in the corresponding row.

See the [MPC X Control Map](#) and [MPC Live Control Map](#) for more information.

All tracks, clips and scenes will display the same color and names as assigned in Ableton Live. The pads on your MPC hardware will also change color depending on the playback or recording state:

When a clip is stopped, it will display the color set in Ableton Live on both the hardware pads and display.

When a clip is playing, the hardware pad will blink green, and the clip on the display will fill with white based on the clip length.

When a clip is preparing to record, it will flash red on both the hardware pads and display until the launch quantization value is reached.

When a clip is recording, it will blink red on the hardware pads and be lit red on the display.

You can also access the following controls and features by tapping the buttons at the bottom of the display:

Tap **Quantize** at the bottom of the screen to quantize the currently selected clip according to the **Quantize To** value (set in the Ableton Live Control [Settings](#)).

Tap **Delete** at the bottom of the screen to delete the currently selected clip.

Tap **Insert Scene** at the bottom of the screen to insert a new scene after the currently selected clip.

Tap **Rec** at the bottom of the screen to enable or disable Ableton Live's Arrangement Record. Use this to capture your Session performance into the Arrangement view.

## Mixer View

The Mixer View gives you control of Ableton Live's key mixing features, such as levels, stereo panning, sends and returns and more. Use the tabs at the bottom of the display to select what information is shown on MPC's display.

- **Levels:** The Levels tab gives you an overview of the volume level of your tracks, including the Returns and the Main Output track.
  - Tap a **level slider** and then use the **data dial** or **-/+** buttons to adjust the volume level of the currently selected track, return or main output. Alternatively, tap and drag a **level slider** to adjust the volume level.
  - The level sliders and meters in each pad show a visual representation of the level. Double-tap a **track** on the screen to open a large version of the level slider and meter.
- **Main:** The Main tab gives you a full channel strip with a number of mixing options for your tracks.
  - Tap the **track activator** (under the track name) to enable or disable (mute) the track.
  - Tap the **S** button to solo the track.
  - Tap the **record button** to arm the track for recording.
  - The **pan sliders** in each track show a visual representation of the pan. Tap a pan slider and then use the **data dial** or **-/+** buttons to adjust the panning of the currently selected track, return or main output. Alternatively, tap and drag the **pan slider** to adjust the panning. Double-tap a pan slider on the screen to open a large version of the slider.
  - Tap a **level slider** and then use the **data dial** or **-/+** buttons to adjust the volume of the currently selected track, return or main output. Double-tap a level slider on the screen to open a large version of the slider. Alternatively, tap and drag a **level slider** to adjust the volume level.
- **Sends:** The **Sends** tab gives you an overview of the Send and Return controls in Ableton Live.
  - Use the **send knobs** to adjust the send level of tracks. Tap the knob and use the **data dial** or **-/+** buttons to adjust the level. Alternatively, tap and drag the **send knob** to adjust the send level.
  - Tap the **A** or **B** icons to assign the track to the Ableton Live's A or B cue mix.

## Device Control View

The Device Control View allows you to control MIDI Instruments, Audio Effects and other Devices in Ableton Live directly from your MPC. The current view of the Device Control Tab is determined by the "blue hand" remote control icon in Ableton Live's Detail View.

- Tap the **Track Name** under the Control Bar to select the Track. If there is a Device(s) associated with the Track, the first will be shown below.
- Tap the **lock icon** on the right side to lock parameter changes to the device.
- Use the **sliders** to adjust the parameters of the device. Tap a **slider** and then use the **data dial** or **-/+** buttons to adjust the parameter. Alternatively, tap and drag a **slider** to adjust the parameter.
- Use the **Device -** and **+** buttons to change devices on the same track. The white and grey boxes below the parameter sliders represent the number of available Devices.
- Use the **Bank -** and **+** buttons to cycle through banks of controls for the device, if available. For internal Ableton Live plugins, you will see the name of the current bank. For third party plugins, you will see the number of the current bank.
- Tap **Device On** to enable or disable (bypass) the device.

## Q-Links

The Q-Links on your MPC give you hands-on control of Ableton Live's key parameters.

On MPC X, **Q-Links 1–8** control track volume for the eight tracks currently in view, while **Q-Links 9–16** control the device on the currently selected track, based on the "blue hand" in Ableton Live's Detail View. The OLED screens above each Q-Link also provide clear visual feedback of the parameter name and value being controlled.

On MPC Live, **Q-Link Banks 1** and **2** control track volume, and **Q-Link Banks 3** and **4** control the current device at the "blue hand" position. Press and hold the **Q-Link** button to bring up the Q-Links Overview on the touchscreen, where you can view the current assignments and quickly select another bank.

MPC X Control Map

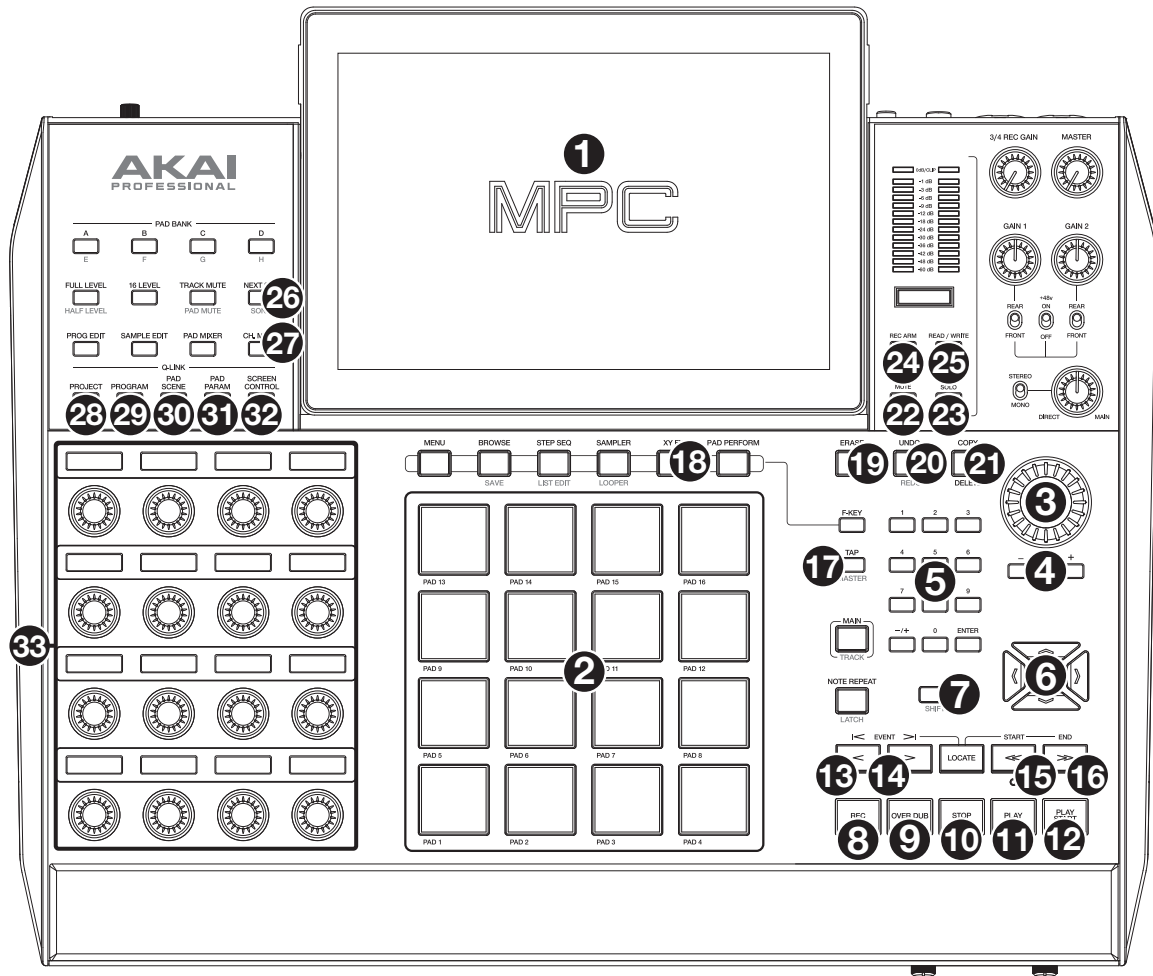

General Controls and Features

| # | Device Control      | Ableton Live Function  |
|---|---------------------|--|
| 1 | Display             | In Ableton Live Control Mode, MPC X's display will show a dynamic representation of Ableton Live's software.   |
| 2 | Pads                | Press the pads to launch clips or scenes. Press the <b>XYFX</b> button to toggle between launching clips (the button is off) and launching scenes (the button is on).  |
| 3 | Data Dial           | Adjusts the highlighted field.   |
| 4 | -/+                 | Decreases or increases the value of the highlighted field.   |
| 5 | Numeric Input       | If the selected field on the screen is a number, press these numbered buttons as you would on a standard numeric keypad to enter a value. Press the keypad's <b>Enter</b> to enter it. (A numeric keypad with additional operations will appear on the screen, as well.) |
| 6 | Directional Cursors | Moves the 4x4 Session Matrix focus on the display by one row or one column at a time.  |
| 7 | Shift               | Hold this button to access secondary button functions. See <b>Shift Controls</b> for more details.   |



## Transport Controls

| #  | Device Control | Ableton Live Function                              |
|----|----------------|--|
| 8  | Record         | Enable and disable Arrangement Record              |
| 9  | Overdub        | Enable and disable Session Record.                 |
| 10 | Stop           | Stop playback.                                     |
| 11 | Play           | Start playback from the Stop position.             |
| 12 | Play Start     | Start playback from the Arrangement start (1:1:1). |
| 13 | <              | Move Playhead back by one bar                      |
| 14 | >              | Move Playhead forward by one bar                   |
| 15 | <<             | Phase Nudge down                                   |
| 16 | >>             | Phase Nudge up                                     |

## Right-Hand Side Buttons

| #  | Device Control | Ableton Live Function   |
|----|----------------|---|
| 17 | Tap Tempo      | Tap this button at the desired rate to set a new tempo in Ableton Live.                 |
| 18 | XYFX           | Toggles the MPC pads between launching clips (XYFX off) and launching scenes (XYFX on). |
| 19 | Erase          | Deletes the selected clip.  |
| 20 | Undo           | Undo the last action.   |
| 21 | Copy           | Duplicates the selected clip into the next available clip slot.                         |
| 22 | Mute           | Mutes/deactivates the current track.  |
| 23 | Solo           | Solos the current track.  |
| 24 | Rec Arm        | Arms the current track for recording.   |
| 25 | Read/Write     | Arms Global Automation.   |

## Left-Hand Side Buttons

| #  | Device Control        | Ableton Live Function   |
|----|-----------------------|---|
| 26 | Next Seq              | Opens the Ableton Clip Launch Matrix tab  |
| 27 | Ch. Mixer             | Opens the Ableton Mixer tab.  |
| 28 | Q-Link Project        | Moves to the previous device.   |
| 29 | Q-Link Program        | Moves to the next device.   |
| 30 | Q-Link Pad Scene      | Device Control Bank Left  |
| 31 | Q-Link Pad Param      | Device Control Bank Right   |
| 32 | Q-Link Screen Control | Opens the Ableton Device Control tab  |
| 33 | Q-Links               | Adjusts the currently selected parameters displayed in the OLED screens above.<br><b>Q-Links 1–8</b> control track volume for the eight tracks currently in view, while <b>Q-Links 9–16</b> control the device on the currently selected track, based on the "blue hand" in Ableton Live's Detail View. |

### Shift Controls

Press and hold MPC X's **Shift** button, and then press the following buttons for additional actions.

| #  | Device Control      | Ableton Live Function   |
|----|---------------------|---|
| 2  | Pads                | Selects a clip without launching it.  |
| 6  | Directional Cursors | Moves the 4x4 Session Matrix focus on the display by eight rows or eight columns at a time. |
| 10 | Stop                | Stop playback and return song position to 1:1:1.  |
| 17 | Tap Tempo           | Toggle the metronome on and off.  |
| 21 | Undo                | Redo the last action.   |

### MPC Live Control Map

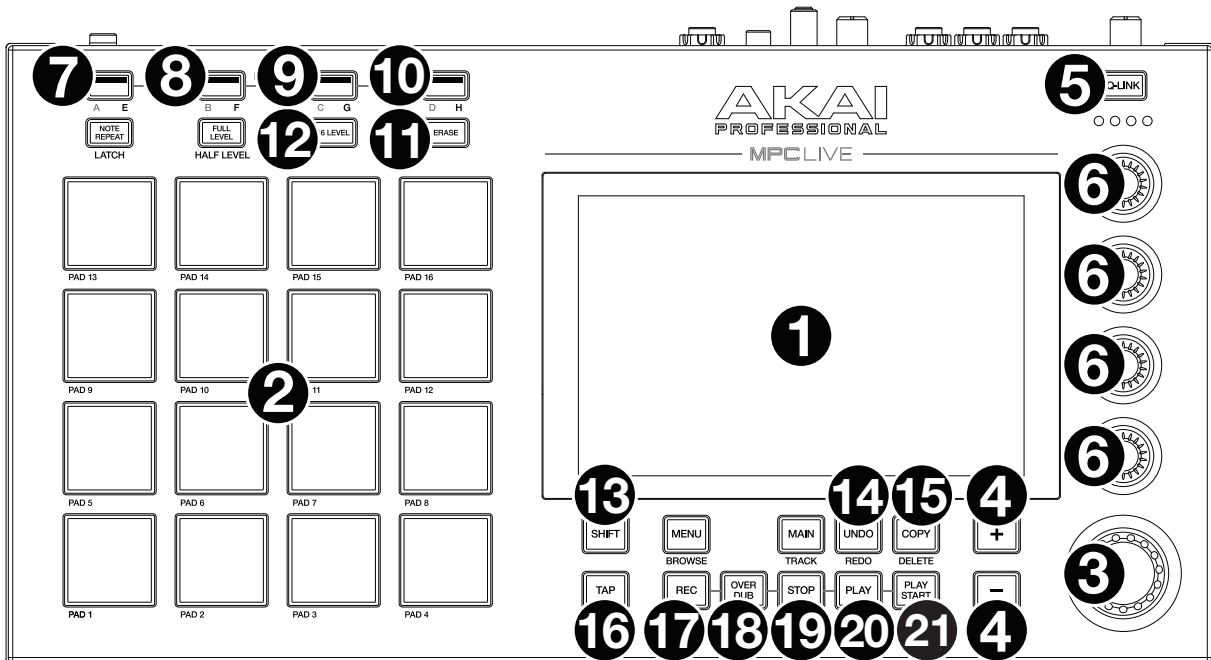

### Basic Controls

| # | Device Control | Ableton Live Function   |
|---|----------------|---|
| 1 | Display        | In Ableton Live Control Mode, MPC Live's display will show a dynamic representation of Ableton Live's software.   |
| 2 | Pads           | Press the pads to launch clips or scenes. Press the <b>16 Level button</b> to toggle between launching clips (the button is off) and launching scenes (the button is on). |
| 3 | Data Dial      | Adjusts the highlighted field.  |
| 4 | -/+            | Decreases or increases the value of the highlighted field.  |
| 5 | Q-Link Button  | Press this button to move forward between Q-Link Banks 1–4. Push and hold this button to bring up the Q-Links Overview window on the display.                             |

| #  | Device Control | Ableton Live Function  |
|----|----------------|--|
| 6  | Q-Links        | Adjusts the currently selected parameters.<br>Use the <b>Q-Link button</b> to toggle between Q-Link Banks 1 and 2 (which control Track Level for the eight tracks currently viewed) and Banks 3 and 4 (which are mapped to control the device on the current track, based on the location of the "blue hand" in Ableton Live's Detail View). |
| 7  | Bank A/E       | Move the 4x4 Session Matrix focus up by one row.   |
| 8  | Bank B/F       | Move the 4x4 Session Matrix focus down by one row.   |
| 9  | Bank C/G       | Move the 4x4 Session Matrix focus left by one column.  |
| 10 | Bank D/H       | Move the 4x4 Session Matrix focus right by one column.   |
| 11 | Erase          | Deletes the selected clip.   |
| 12 | 16 Level       | Toggles the MPC pads between launching clips (16 Level off) and launching scenes (16 Level on).  |
| 13 | Shift          | Hold this button to access secondary button functions. See <a href="#">Shift Controls</a> for more details.  |
| 14 | Undo           | Undo the last action.  |
| 15 | Copy           | Duplicates the selected clip into the next available clip slot.  |
| 16 | Tap            | Tap this button at the desired rate to set a new tempo in Ableton Live.  |
| 17 | Rec            | Enable and disable Arrangement Record.   |
| 18 | Overdub        | Enable and disable Session Record.   |
| 19 | Stop           | Stop playback.   |
| 20 | Play           | Start playback from the current playhead position.   |
| 21 | Play Start     | Start playback from the Arrangement start (1:1:1).   |

### Shift Controls

Press and hold MPC's **Shift** button, and then press the following buttons for additional actions.

| #  | Device Control | Ableton Live Function                                     |
|----|----------------|---|
| 2  | Pads           | Selects a clip without launching it.                      |
| 5  | Q-Link Button  | Move backward between Q-Link Banks 1–4.                   |
| 7  | Bank A/E       | Move the 4x4 Session Matrix focus up by eight rows.       |
| 8  | Bank B/F       | Move the 4x4 Session Matrix focus down by eight rows.     |
| 9  | Bank C/G       | Move the 4x4 Session Matrix focus left by eight columns.  |
| 10 | Bank D/H       | Move the 4x4 Session Matrix focus right by eight columns. |
| 13 | Undo           | Redo the last action.                                     |
| 15 | Tap            | Toggle the metronome on and off.                          |
| 18 | Stop           | Stop playback and return song position to 1:1:1.          |

## Ethernet Adapter Support

Standalone MPC hardware now supports USB-to-Ethernet adapters. Ethernet settings can be set in the Ethernet tab of the Preferences menu.

## Improved Preferences Organization

The Preferences menu has been updated with improved organization. Wi-Fi, Ethernet and Bluetooth tabs have been grouped and are now located beneath the **Info** tab. (This has been updated in [Operation > General Features > Menu > Preferences](#).)

## Updates in MPC 2.7.2

### New Features

#### MPC One Support

MPC 2.7.2 adds support for the Akai Professional MPC One hardware.

**Note:** Ableton Live Control is not available for MPC One.

## Updates in MPC 2.7.3

### New Features

#### MPC Live II Support

MPC 2.7.3 adds support for the Akai Professional MPC Live II hardware.

#### MPC Live II Ableton Live Control

The MPC Live II hardware is also pre-mapped to control Ableton Live 10.1.2 or later. See [Addenda > Updates in MPC 2.7 > New Features > Ableton Live Control](#) for more information on how to use Live Control Mode.

**Note:** You can control Ableton Live over a Wi-Fi network for cableless operation, or connect MPC Live II to your computer using an Ethernet cable for a more tightly controlled setup.

#### MPC Live II Control Map

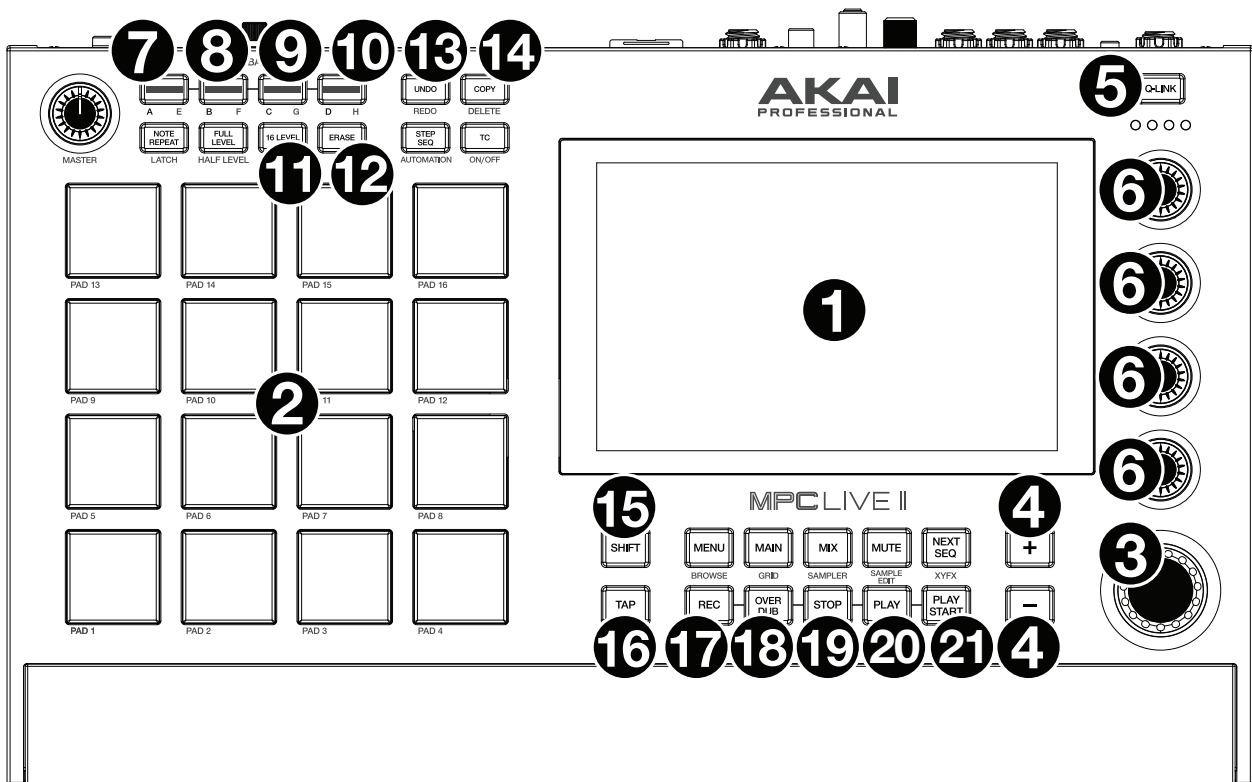

#### Basic Controls

| # | Device Control | Ableton Live Function   |
|---|----------------|---|
| 1 | Display        | In Ableton Live Control Mode, MPC Live II's display will show a dynamic representation of Ableton Live's software.  |
| 2 | Pads           | Press the pads to launch clips or scenes. Press the <b>16 Level button</b> to toggle between launching clips (the button is off) and launching scenes (the button is on). |
| 3 | Data Dial      | Adjusts the highlighted field.  |
| 4 | -/+            | Decreases or increases the value of the highlighted field.  |

| #  | Device Control | Ableton Live Function  |
|----|----------------|--|
| 5  | Q-Link Button  | Press this button to move forward between Q-Link Banks 1–4. Push and hold this button to bring up the Q-Links Overview window on the display.  |
| 6  | Q-Links        | Adjusts the currently selected parameters.<br><br>Use the <b>Q-Link button</b> to toggle between Q-Link Banks 1 and 2 (which control Track Level for the eight tracks currently viewed) and Banks 3 and 4 (which are mapped to control the device on the current track, based on the location of the "blue hand" in Ableton Live's Detail View). |
| 7  | Bank A/E       | Move the 4x4 Session Matrix focus up by one row.   |
| 8  | Bank B/F       | Move the 4x4 Session Matrix focus down by one row.   |
| 9  | Bank C/G       | Move the 4x4 Session Matrix focus left by one column.  |
| 10 | Bank D/H       | Move the 4x4 Session Matrix focus right by one column.   |
| 11 | Erase          | Deletes the selected clip.   |
| 12 | 16 Level       | Toggles the MPC pads between launching clips (16 Level off) and launching scenes (16 Level on).  |
| 13 | Undo           | Undo the last action.  |
| 14 | Copy           | Duplicates the selected clip into the next available clip slot.  |
| 15 | Shift          | Hold this button to access secondary button functions. See <a href="#">Shift Controls</a> for more details.  |
| 16 | Tap            | Tap this button at the desired rate to set a new tempo in Ableton Live.  |
| 17 | Rec            | Enable and disable Arrangement Record.   |
| 18 | Overdub        | Enable and disable Session Record.   |
| 19 | Stop           | Stop playback.   |
| 20 | Play           | Start playback from the current playhead position.   |
| 21 | Play Start     | Start playback from the Arrangement start (1:1:1).   |

## Shift Controls

Press and hold MPC Live II's **Shift** button, and then press the following buttons for additional actions.

| #  | Device Control | Ableton Live Function                                     |
|----|----------------|---|
| 2  | Pads           | Selects a clip without launching it.                      |
| 5  | Q-Link Button  | Move backward between Q-Link Banks 1–4.                   |
| 7  | Bank A/E       | Move the 4x4 Session Matrix focus up by eight rows.       |
| 8  | Bank B/F       | Move the 4x4 Session Matrix focus down by eight rows.     |
| 9  | Bank C/G       | Move the 4x4 Session Matrix focus left by eight columns.  |
| 10 | Bank D/H       | Move the 4x4 Session Matrix focus right by eight columns. |
| 13 | Undo           | Redo the last action.                                     |
| 16 | Tap            | Toggle the metronome on and off.                          |
| 19 | Stop           | Stop playback and return song position to 1:1:1.          |

## Updates in MPC 2.8

### New Features

#### MIDI Improvements

MPC now supports multi-MIDI control, making MPC the ultimate MIDI sequencing studio centerpiece. In addition to getting the most out of the MIDI DIN ports on your MPC hardware, you can now use your hardware's USB ports to connect class-compliant MIDI devices such as USB keyboards, MIDI interfaces and USB-to-CV modules, allowing you to dramatically increase the MIDI input and output capabilities of MPC.

**Note:** To use multiple USB MIDI devices with standalone MPC, we recommend using a high-quality, powered USB hub.

#### Configuring MIDI

To configure the MIDI Inputs and Outputs, go to [Preferences > MIDI / Sync](#).

The **Input Ports** section displays all available MIDI input ports in a list. Tap the **keyboard icon** to rename a port to a custom name. This is particularly useful when using multiple devices connected to a single MIDI interface or hub, as you can name the ports according to the devices connected to them. The custom port names will be reflected throughout the internal software.

Next to each MIDI input port are the **Global**, **Control** and **Track** buttons:

- When **Global** is enabled, MIDI data from this port will always go to the current track. The MPC Pads are an example of a device that is always Global.
- When **Control** is enabled, MIDI data from this port will be sent to MIDI Learn.
- When **Track** is enabled, this MIDI port will appear in the list of available track MIDI Inputs.

The **Output Ports** section displays all available MIDI output ports in a list. Tap the **keyboard icon** to rename a port to a custom name.

Next to each MIDI output port are the **Sync** and **Track** buttons:

- When **Sync** is enabled, the MIDI output port will send MIDI sync messages according to the type set in the Preferences menu under **MIDI / Sync > Sync Send > Send**.
- When **Track** is enabled, the MIDI output port will appear in the list of available track MIDI Outputs.

By default, the **Track Enable Ports When Discovered** option is set to **On** so that when any MIDI device is plugged in, the **Track** option is automatically enabled so the ports can be selected as an available MIDI input or output.

#### To configure the MIDI Input and Output for a track:

1. In **Track View**, use the **MIDI Input** and **Channel** fields to set the desired MIDI input port and channel. For tracks where the **Program** type is set to **MIDI**, you can also set the MIDI **Output** port and **Channel**.
2. In **Main Mode**, open the channel strip by tapping the **eye icon**. Set the channel strip view to **Track** by tapping the **bars icon** and then use the **MIDI Input/Output Ports**, **Input/Output Channels** and/or **Send To** fields to configure the MIDI settings.
3. In **Channel Mixer Mode**, set the **Mixer** field at the top of the touchscreen in the toolbar to **MIDI Tracks**, and then use the Channel Strip to adjust the **MIDI Input/Output Ports**, **Input/Output Channels** and/or **Send To** fields to configure the MIDI settings.

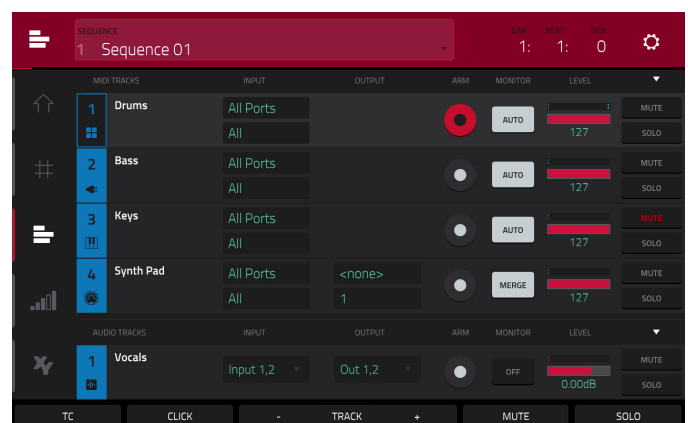



You can now also send MIDI from one track to another to layer two or more sound generators. For example, to layer two plugin instruments:

1. On Track 1, set the **Program Type** to Plugin and select a plugin instrument and preset.
2. On Track 2, also set the **Program Type** to Plugin and press the **Program +** icon to create a second plugin program. Select a new plugin instrument and preset.
3. Open **Main Mode** and select **Track 1**.
4. Open the **Channel Strip** by pressing the **eye icon** and then select Track view by tapping the **bars icon**.
5. Use the **Send To** field to select **Track 2**.
6. Now, any note input or MIDI from Track 1 will automatically be sent to Track 2 as well, giving you a quick and easy way to layer two sounds.

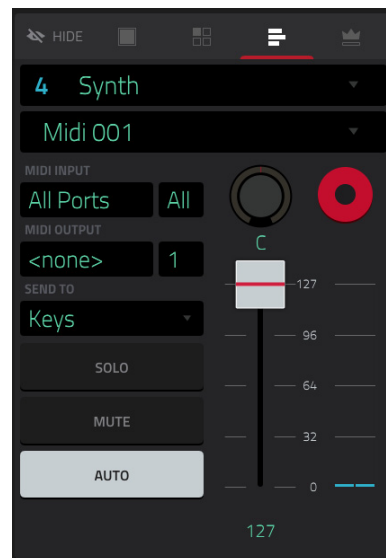

## MIDI Recording

For recording, MIDI Tracks now have an **Input Monitor** button with four states:

- **Off:** The track's MIDI input is not monitored, and playback of recorded events will be heard. This setting is useful when using keyboards with Local Control active.
- **In:** The track's MIDI input is always monitored regardless of the track's Record Arm state, and playback from recorded events will not be heard.
- **Auto:** The track's MIDI input is monitored when the track is record armed, and playback of recorded events will be heard.
- **Merge:** The track's MIDI input is always monitored, and playback of recorded events will be heard.

## Copy Pads

You can now copy one or more pads from one drum program to another. This process is available with other program editing processes. (This has been added to [Operation > Modes > Main Mode > Program Section](#)).

**To show the Copy Pads window**, tap the **pencil icon** on the right edge of the Program section in Main Mode. After the Program Edit window opens, tap **Copy Pads**.

Use the **Copy Type** menu to select the whether you want to copy an individual **Pad**, a **Bank** of pads or a **Range** of pads. Use the fields that appear to select the **Pad**, **From Bank** or **Start/End Pads** that will be copied.

Use the **From Program** menu to select the program from which the pads will be copied.

Use the **To Program** menu to select the program to which the copied pads will be added.

Use the **Pad**, **To Bank** or **Start Pad** where the copied pads will be added starting from.

Click **Apply** to confirm your setting, and then click **Do It** to copy the pads or **Cancel** to return to the previous screen.

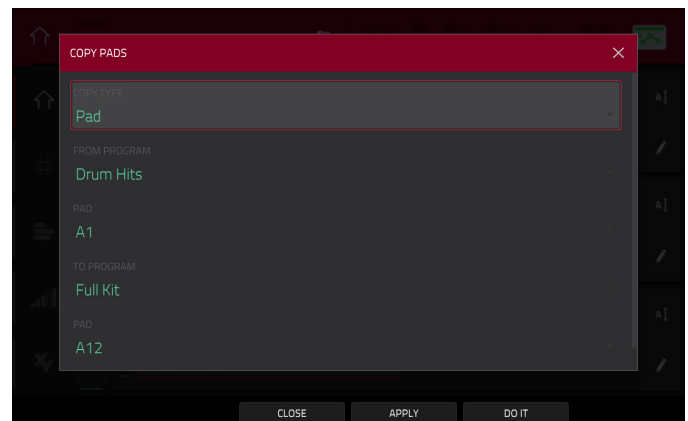

## Custom Progressions

You can now create custom Progressions based on the current MIDI track from your standalone hardware. This process is available with other track editing processes. (This has been added to [Operation > Modes > Main Mode > Track Section](#)).

**To show the Convert to Progression window,** tap the **pencil icon** on the right edge of the Track section in Main Mode. After the Track Edit window opens, tap **Convert to Progression**.

Use the **Progression** fields to set the parameters of the new Progression.

**To set the progression name,** use the **Name** field.

**To set the root note,** use the **Root Note** field.

**To set the scale type,** use the **Scale Type** field.

Use the **Chord** fields to set the parameters for the chords in your progression.

**To select a chord from the progression to edit,** use the **Chord** field.

**To rename the selected chord,** use the **Name** field.

**To set the type of chord,** use the **Type** field to select **Root**, **Normal** or **Below Root**.

**To play the selected chord,** tap the **Play** button.

**To close the window and return to the previous screen,** tap the **X**, **Close** or anywhere outside the window.

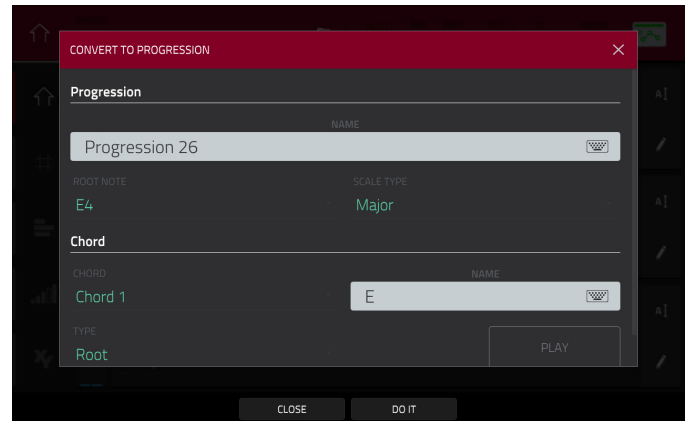

## Edit Pad MIDI Note Map

You can now create custom note mappings for any program type directly from your standalone MPC hardware. Note mapping lets you assign specific MIDI notes to your pads in each program, except for keygroup programs. This process is available with other track editing processes. (This has been added to [Operation > Modes > Main Mode > Program Section](#)).

**To show the Edit Pad MIDI Note Map window,** tap the **pencil icon** on the right edge of the Program section in Main Mode. After the Program Edit window opens, tap **Edit Pad Map**.

Use the **Pad** field to select the pad to edit. You can also press a pad to select it.

Use the **MIDI Note** field to set the corresponding MIDI Note for the pad.

Use the **Presets** buttons to quickly apply one of three common pad layout presets: **Chromatic C-2**, **Classic MPC** and **Chromatic C1**.

**To close the window and return to the previous screen,** tap the **X**, **Close** or anywhere outside the window.

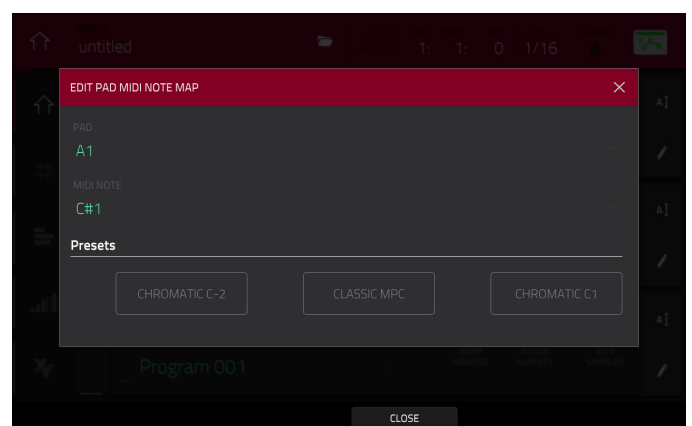

## Global Automation Button

All automation buttons, including the **global automation button** (available in Main Mode, Grid View, XYFX Mode, List Edit Mode, the Pad Mixer, the Channel Mixer, Pad Mute Mode, and Q-Link Edit Mode) and the **program automation buttons** (available in Main Mode and the Channel Mixer) now toggle between **Read** and **Write** states when tapped. To turn automation off or on, hold **Shift** and tap the **global automation button** or **program automation button**.

Pressing the **Read/Write** button on MPC X now also toggles between **Read** and **Write** states. Hold the **Shift** button and press **Read/Write** to turn automation off or on.

## Global Timing Correct On/Off

The **Timing Correct (TC)** window now has a convenient **Global Timing Correct On/Off** button.

You can also enable or disable Global Timing Correct by holding **Shift** and tapping the **TC** value at the top of the screen in Main Mode or List Edit Mode.

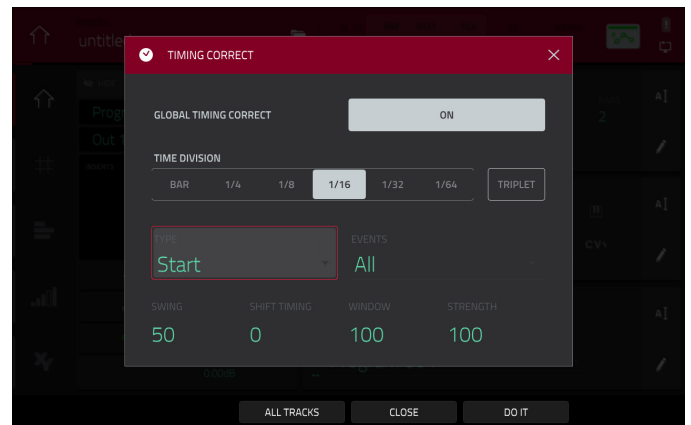

## Main Button Track Select

You can now press and hold the **Main** button to view the **Select Track** window where you can select a track by pressing the corresponding pad or tapping the pad in the **Select Track** window.

Use the **MIDI** and **Audio** tabs to switch between track types.

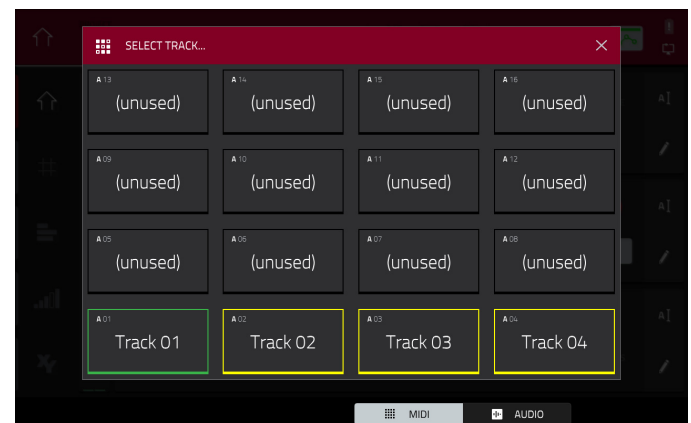

## Expanded Pad Perform

You can now easily open and use Pad Perform from Main Mode and other modes where the pads play notes.

**To open the Pad Perform window in Main Mode,** tap the **Pad Perform** icon in the program section when using a plugin, keygroup or MIDI program.

**To open the Pad Perform window in other modes,** hold **Shift** and press **16 Level**. Alternatively, press **Pad Perform** (MPC X only).

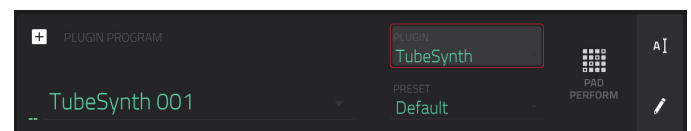

## Retrospective Record

Your MPC hardware now captures MIDI events in the background, allowing you to recall performances when record was not enabled.

To capture events using retrospective record, hold **Shift** and press **Record** after playing some notes to add the recent events to the current track.

## Single or Multi Record Arm

You can now configure the behavior of the Record Arm buttons by adjusting the **Record Arm** setting under [Preferences > Sequencer](#).

- In **Single** mode, selecting a different track will automatically arm that track and disarm all other tracks. This is the default mode and is the same as previous MPC releases. To arm multiple tracks to record in Single mode, hold **Shift** and tap each track's record button.
- In **Multi** mode, you can tap any track's record button to add it to the group of armed tracks. This is useful when doing multitrack recording.

## Q-Link Overlay

MPC Live, MPC Live MKII, MPC One and MPC Touch now display visual feedback when a Q-Link knob is touched. A panel will appear on the right side of the touchscreen showing the available parameters being controlled and their values.

(This has been added to [Preferences > General](#)).

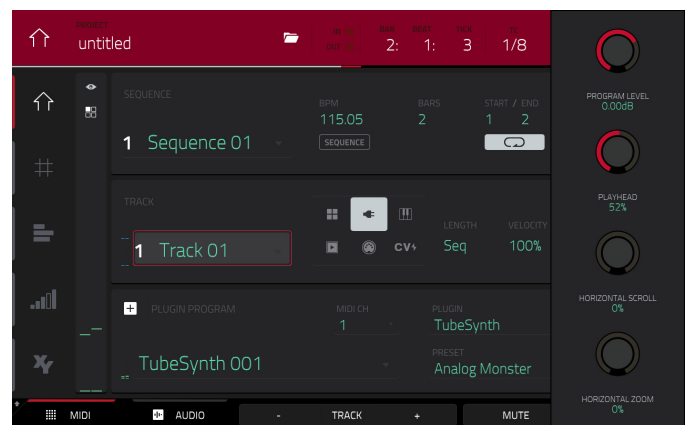

## Updates in MPC 2.9

### New Features

#### AIR DrumSynth

The AIR DrumSynth plugins emulate the sound of classic drum machines and feature multiple synthesis types, advanced modeling and carefully crafted, built-in effects to create powerful contemporary drum sounds.

##### To use AIR DrumSynth:

1. Create a Plugin program.
2. Double-tap the **Plugin** field to open the Plugin window.
3. Expand the **MPC Drum Plugins** option and select the desired plugin.

You can add the following drum types as individual plugins per track: **Clap**, **Crash**, **HiHat**, **Kick**, **Perc**, **Ride**, **Snare** and **Tom**. Each of these instruments has comprehensive synthesis and effects sections described below.



In each plugin, you can quickly enable or disable the built-in effects (**Transient**, **Distortion**, **EQ** and **Compressor**) while viewing any of the tabs listed below by tapping the buttons on the right side of the touchscreen under **FX**.

#### Drum Sound

Use this tab to adjust the basic settings for the drum sound. You can also use the knobs on this tab to quickly adjust up to eight parameters specifically chosen for each sound.

| Parameter       | Description  | Value Range                |
|-----------------|--|----------------------------|
| Model           | Type of drum sound emulated.   | Varies                     |
| One-Shot        | Allows the drum sound to play entirely when triggered or only for how long the note length is set.   | Enabled, Disabled          |
| Velocity        | Amount of incoming Velocity applied. When set to 0, all notes will sound as if Full Level.   | 0–100%                     |
| Velocity 2      | Amount of additional Velocity envelope that can be used to control a parameter.  | -100 – 0 – +100%           |
| Target          | Select the Parameter where the Velocity 2 information is sent.   | Param 1–8                  |
| Gain            | Volume level of the drum sound.  | -Inf, -68.0 – 0 – +12.0 dB |
| Parameter Knobs | Each drum sound has up to eight associated parameters that can be used to further shape the sound. The available parameters vary based on the type of drum sound selected. Use the knobs to adjust the selected parameter. | Varies                     |

**Trans/Dist**

Use this tab to adjust the settings for the Transient and Distortion effects.

| Parameter  |           | Description   | Value Range      |
|------------|-----------|---|------------------|
| Transient  | Attack    | Decreases or increases the amount of transient attack applied to the signal.          | -100 – 0 – +100% |
|            | Shape     | Adjusts the shape of the processed transient.   | 0–100%           |
|            | Sustain   | Percentage of sustain envelope subtracted from or added to the transient effect.      | -100 – 0 – +100% |
| Distortion | Pre-Shape | Increases or decreases the high-end tone of the incoming audio signal pre-distortion. | -100 – 0 – +100% |
|            | Drive     | Amount of drive applied.  | 0–60 dB          |
|            | Threshold | Signal level after which the distortion will be applied.                              | -20.0–0.0 dB FS  |
|            | High Cut  | Center frequency of the distortion signal high-cut filter.                            | 1.00–20.0 kHz    |
|            | Mix       | Wet/dry amount of the distortion effect.  | 0–100%           |

**EQ/Comp**

Use this tab to adjust the settings for the EQ and Compressor effects.

| Parameter  |               | Description   | Value Range               |
|------------|---------------|---|---------------------------|
| EQ         | High Freq     | Center frequency for the High EQ band.                      | 1.20 – 20.0 kHz           |
|            | High Gain     | Amount of gain applied to the High EQ band.                 | Cut, -12.0 – 0 – +12.0 dB |
|            | High Mid Freq | Center frequency for the High Mid EQ band.                  | 120 Hz – 16.0 kHz         |
|            | High Mid Q    | Width of the High Mid EQ band.                              | 0.40–10.00                |
|            | High Mid Gain | Amount of gain applied to the High Mid EQ band.             | -18.0 – 0 – +18.0 dB      |
|            | Low Mid Freq  | Center frequency for the Low Mid EQ band.                   | 40.0 Hz – 8.00 kHz        |
|            | Low Mid Q     | Width of the Low Mid EQ band.                               | 0.40–10.00                |
|            | Low Mid Gain  | Amount of gain applied to the Low Mid EQ band.              | -18.0 – 0 – +18.0 dB      |
|            | Low Freq      | Center frequency for the Low EQ band.                       | 20.0 Hz – 1.00 kHz        |
|            | Low Gain      | Amount of gain applied to the Low EQ band.                  | Cut, -12.0 – 0 – +12.0 dB |
| Compressor | Ratio         | Amount of compression applied.                              | 1.0:1 – 100.0:1           |
|            | Attack        | Length of time to apply the compression.                    | 100 us – 300 ms           |
|            | Threshold     | Signal level after which the compressor will be applied.    | -60.0–0.0 dB              |
|            | Output        | Amount of additional output gain for the compressed signal. | 0.0–30.0 dB               |

You can also use the **DrumSynth:Multi** plugin to access all DrumSynth sounds from one plugin, which includes additional dedicated effects and mixing controls.

**Note:** You can only have one DrumSynth:Multi plugin active per project when in Standalone mode.

### DrumSynth 1–8 / Trans/Dist / EQ/Comp

Use the first eight tabs in the Multi to control the same parameters as the individual DrumSynth plugins. Tap each tab to cycle between the *Drum Sound* view, the *Trans/Dist* view, and the *EQ/Comp* view.

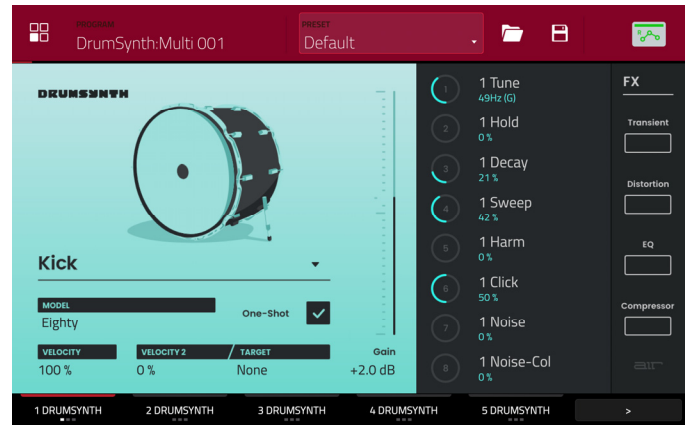

### Send FX

Use this tab to adjust the settings for the Delay, Diffuser and Reverb effects.

| Parameter |             | Description   | Value Range                   |
|-----------|-------------|---|-------------------------------|
| Delay     | Time        | Length of time between the dry signal and the delayed signal.   | 1/32 – 8/4                    |
|           | Ratio       | Reduces the delay <b>Time</b> in either the <b>Left</b> or <b>Right</b> stereo field. This is useful for creating offset, panned delays.  | L 100:50, R 50:100            |
|           | Feedback    | Amount of delay signal fed back into the delay line.  | 0–100%                        |
|           | Filter Freq | Sets the center frequency of the filtered delay signal.   | 1.00 – 20.0 kHz               |
|           | Reso        | Amount of resonance of the feedback signal.   | 0–100%                        |
|           | Reso Freq   | Center frequency for feedback resonance.  | 100 Hz – 10.0 kHz             |
| Diffuser  | Delay       | Delayed time between the dry signal and the diffused signal.  | 1/64 – 4/4                    |
|           | Feedback    | Amount of diffused signal sent back into the delay line.  | 0–100%                        |
|           | Diffusion   | Rate of increasing density of reverb reflections.<br>At lower settings, the sound of individual reflections is more present.<br>At higher settings, reflections are more uniform. | 0–100%                        |
|           | Bright      | Adjusts the high-end tone of the diffused signal.   | 0–100%                        |
| Reverb    | Mode        | Type of reverb applied.   | Hall, Stadium, Room, Abstract |
|           | Time        | Length of reverb tail.  | 0.4 s – +Inf s                |
|           | Low Cut     | Center frequency for the reverb low-pass filter.  | 1 – 1000 Hz                   |
|           | High Cut    | Center frequency for the reverb high-pass filter.   | 1.00 – 20.0 kHz               |

## Mixer / FX / Sends

Use this tab to mix the individual drum sounds as well as control their effects. The **Mixer / FX / Sends** tab contains three different views that can be accessed by tapping the tab at the bottom of the display.

Use the **Mixer** view to adjust the volume, panning, muting and soloing for each drum.

Tap the **1-8** icons to mute or unmute the selected drum.

Tap the **S** icon to solo the selected drum.

Tap and drag the **pan slider** to adjust the drum panning. Alternatively, tap the slider and use the encoder, or use the appropriate Q-Link knob.

Tap and drag the **volume slider** to adjust the drum volume. Alternatively, tap the slider and use the encoder, or use the appropriate Q-Link knob.

Use the **FX** view to enable or disable the Transient, Distortion, EQ and Compressor effects for each drum sound.

Tap the **FX box** to enable or disable the selected FX on the selected drum.

Use the **Sends** view to adjust the send levels for the Delay, Diffuser and Reverb Send FX.

Tap and drag the **Send knob** to adjust the send level for the selected effect on the selected drum. Alternatively, tap the knob and use the encoder, or use the appropriate Q-Link knob.



## Updates in MPC 2.10

### New Features

#### Four New Instrument Plugins

Your MPC hardware now includes four new plugin instruments: *AIR Hype*, *AIR Mellotron*, *AIR Solina* and *WayOutWare Odyssey*.

#### To use the new plugins:

1. Make sure you have downloaded the new Synth Content installation pack from your account at [akaipro.com](http://akaipro.com).
2. Copy the **Synths** directory from the downloaded pack into the top-level folder of a SD card or USB drive. You do not need to copy any of the other files. Then, insert the drive into your device.

**Note:** For maximum convenience, we recommend you install a SATA drive in the drive bay of your standalone MPC and then copy the **Synths** folder onto this drive.

#### AIR Hype

The AIR Hype plugin is a modern style dual-oscillator synthesizer that includes a wide variety of built-in effects for endless combinations of sound, as well as convenient macro controls for lightning-fast adjustments.



#### Macro

Use this tab to adjust the macro settings for the plugin. You can access the Effect on/off switches in all tabs.

| Parameter  | Description   | Value Range          |
|------------|---|----------------------|
| Macros     | These six macro controls are unique to each preset. | Varies               |
| Cutoff     | Amount of filter cutoff applied.                    | 0–100%               |
| Reso       | Amount of filter resonance applied.                 | 0–100%               |
| Mod        | Amount of modulation effect applied.                | 0–100%               |
| Distortion | Amount of distortion effect applied.                | 0–100%               |
| Delay      | Amount of delay effect applied.                     | 0–100%               |
| Reverb     | Amount of reverb effect applied.                    | 0–100%               |
| Pumper     | Amount of pumper effect applied.                    | 0–100%               |
| Volume     | Main output volume.                                 | -inf – 0.0 – +6.0 dB |

AIR Hype (continued)

Filter / Amp

Use this tab to adjust the filter and amplitude envelope settings.

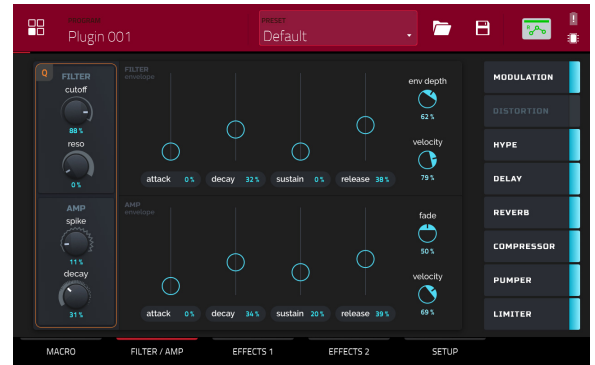

| Parameter       |                   | Description   | Value Range |
|-----------------|-------------------|---|-------------|
| Filter          | Cutoff            | Cutoff frequency for the filter.                                  | 0–100%      |
|                 | Reso              | Amount of resonance of the filter.                                | 0–100%      |
| Filter Envelope | Attack            | Length of time for the filter to reach full level.                | 0–100%      |
|                 | Decay             | Length of time for the filter to reach sustain level.             | 0–100%      |
|                 | Sustain           | Length of time for the filter to hold sustain level.              | 0–100%      |
|                 | Release           | Length of time for the filter to dissipate when released.         | 0–100%      |
|                 | Envelope Depth    | Amount of Filter Envelope added to the filter cutoff.             | 0–100%      |
|                 | Envelope Velocity | Amount of effect the note velocity has on the filter envelope.    | 0–100%      |
| Amp             | Spike             | Applies additional velocity to the amplitude attack.              | 0–100%      |
|                 | Spike Decay       | Length of time for the Spike to decay.                            | 0–100%      |
| Amp Envelope    | Attack            | Length of time for the note to reach full level.                  | 0–100%      |
|                 | Decay             | Length of time for the note to reach sustain level.               | 0–100%      |
|                 | Sustain           | Length of time for the note to hold sustain level.                | 0–100%      |
|                 | Release           | Length of time for the note to dissipate when released.           | 0–100%      |
|                 | Fade              | Amount added to the envelope sustain level.                       | 0–100%      |
|                 | Velocity          | Amount of effect the note velocity has on the amplitude envelope. | 0–100%      |

AIR Hype (continued)

Effects 1

Use this tab to adjust the settings for the Low-Frequency Oscillator and Modulation, Distortion and Hype effects.



| Parameter  |        | Description  | Value Range                                      |
|------------|--------|--|--|
| LFO        | Rate   | Speed of the low frequency oscillator.<br><br>When <b>Sync</b> is set to <b>1st Note, Each Note, or Off</b> : 0.03 – 30.00 Hz<br>When <b>Sync</b> is set to <b>Temp+Note</b> or <b>Tempo+Beat</b> : 8/4 – 1/64 |  |
|            | Sync   | Enables or disables LFO sync, and sets how it is synced when enabled.  | Off, 1st Note, Each Note, Tempo+Note, Tempo+Beat |
|            | Depth  | Amount of LFO modulation applied.  | 0–100%   |
| Mod        | Rate   | Speed of modulation.   | 0.05 – 20.00 Hz                                  |
|            | Adjust | Length of time the wet signal is offset from the dry signal.   | 0.0 – 24.0 ms                                    |
|            | Depth  | Amount of modulation applied.  | 0–100%   |
|            | Mix    | Wet/dry mix of the modulation effect.  | 0–100%   |
| Distortion | Drive  | Amount of drive applied.   | 0–100%   |
|            | Bias   | Emulates amount of voltage sent to a tube power-amp.   | -100 – 0 – 100%                                  |
|            | Output | Output level of the distorted signal.  | 0–100%   |
|            | Mix    | Wet/dry mix of the distortion effect.  | 0–100%   |
| Hype       | Low    | Dampens or maximizes low end frequencies.  | -12.0 – 0.0 – +12.0 dB                           |
|            | Lo-Mid | Dampens or maximizes low-mid frequencies.  | -20.0 – 0.0 – +20.0 dB                           |
|            | Hi-Mid | Dampens or maximizes high-mid frequencies.   | -20.0 – 0.0 – +20.0 dB                           |
|            | High   | Dampens or maximizes high end frequencies.   | -12.0 – 0.0 – +12.0 dB                           |

**AIR Hype** (continued)

**Effects 2**

Use this tab to adjust the settings for the Delay, Reverb, Compressor, Pumper and Limiter effects.



| Parameter  |           | Description  | Value Range            |
|------------|-----------|--|------------------------|
| Delay      | Time      | Amount of time between the dry signal and the delayed signal.  | 1/16 – 16/4            |
|            | Feedback  | Amount of signal fed back into the delay line.   | 0–100%                 |
|            | Freq      | Adjusts the filter cutoff frequency of the delayed signal.   | 100 – 16000 Hz         |
|            | Mix       | Wet/dry amount of the delay effect.  | 0–100%                 |
|            | L/R       | Reduces the delay <b>Time</b> in either the <b>Left</b> or <b>Right</b> stereo field. This is useful for creating offset, panned delays. | L 50:100 – R 100:50    |
| Reverb     | Pre-Delay | Length of time between dry signal and reverberated signal.   | 0.0 – 250.0 ms         |
|            | Time      | Length of reverb tail.   | 0.3 – 60.0 s           |
|            | Mix       | Wet/dry amount of the reverb effect.   | 0–100%                 |
| Compressor | Threshold | Signal level after which the compressor will be applied.   | -30.0 – 0.0 – +10.0 dB |
|            | Ratio     | Amount of compression applied.   | 1.0:1 – 20.0:1         |
|            | Attack    | Length of time to apply the compression.   | 0–100%                 |
|            | Output    | Amount of additional output gain for the compressed signal.  | -20.0 – 0.0 – +20.0 dB |
| Pumper     | Rate      | Speed of the pumper effect.  | Bar, 1/2 – 1/32T       |
|            | Depth     | Amount of signal attenuation by the effect.  | 0–100%                 |
|            | Release   | Amount of time to release the effect.  | 0–100%                 |
| Limiter    | Drive     | Amount of drive added after the limiter effect.  | 0.0 – 30.0 dB          |

AIR Hype (continued)

Setup

Use this tab to adjust the plugin setup parameters.



| Parameter    | Description | Value Range  |  |
|--------------|-------------|--|--|
| Setup        | Transpose   | Transposition of the plugin, in semitones.   | -36 – 0 – +36  |
|              | Tune        | Fine tuning of the plugin, in cents.   | -100 – 0 – +100  |
|              | Glide Time  | Amount of time to slide from the pitch of one note to the next note played.                | 0 ms – 32 s  |
|              | Glide Mode  | Enables or disables pitch gliding for all triggered notes or legato notes.                 | Off, Legato, All   |
|              | Mode        | Sets the plugin to polyphonic or monophonic  | Poly, Mono   |
|              | Del-Rev     | Level of the delay and reverb signals.   | -inf – 0.0 – +6.0 dB   |
|              | Volume      | Overall level of the plugin.   | -inf – 0.0 – +6.0 dB   |
| MIDI Control |             |  |  |
| Mod Wheel    | Destination | Send Mod Wheel data to one of the following control destinations.                          | Pitch, Cutoff, Reso, Amp, Pan  |
|              | Depth       | Amount of modulation applied.  | When <b>Destination</b> is set to <b>Pitch</b> : -12.0 – +12.0<br>When <b>Destination</b> is set to <b>Cutoff, Reso, Amp</b> or <b>Pan</b> : -100 – 0 – 100%                 |
|              | LFO         | Ties the modulation to the Control LFO.  | Off, On  |
| Aftertouch   | Destination | Send Aftertouch data to one of the following control destinations.                         | Pitch, Cutoff, Reso, Amp, Pan  |
|              | Depth       | Amount of modulation applied.  | When <b>Destination</b> is set to <b>Pitch</b> : -12.0 – +12.0<br>When <b>Destination</b> is set to <b>Cutoff, Reso, Amp</b> or <b>Pan</b> : -100 – 0 – 100%                 |
|              | LFO         | Ties the modulation to the Control LFO.  | Off, On  |
| Control LFO  | Sync        | Enables or disables Control LFO sync, and sets how the Control LFO is synced when enabled. | Off, First Note, Each Note, Tempo + Note, Tempo + Beat   |
|              | Rate        | Speed of modulation of the Control LFO.  | When <b>Sync</b> is set to <b>First Note</b> or <b>Each Note</b> : 0.03 – 30.00 Hz<br>When <b>Sync</b> is set to <b>BPM &amp; Note</b> or <b>BPM &amp; Beat</b> : 8/4 – 1/64 |
|              | Shape       | Waveshape of the Control LFO.  | Sine, Triangle, Sawtooth, Square, S&H Random, S&H Alternate, Random Drift, Slow Drift  |

## AIR Mellotron

The AIR Mellotron plugin is a software recreation of the classic tape keyboard, including reproductions of the original tape samples in both clean and dirty versions.

### Model

Use this tab to adjust the settings for the tape sample.



| Parameter  | Description   | Value Range  |
|------------|---|--|
| Sample     | Select the tape loop sample.  | 8 Voice Choir, Boys Choir, Flute, Violins 1, Violins 2, Violin |
| Clean      | Enables or disables a cleaner sample sound.                             | Off, On  |
| Formant    | Decreases or increases the harmonic resonance of the formant frequency. | -12 – 0 – +12  |
| Age        | Amount of sound degradation applied.                                    | 0–100%   |
| Smpl Start | Starting point of the tape loop sample.                                 | 0–100%   |
| Cutoff     | Amount of filter cutoff applied.  | 0–100%   |
| Attack     | Length of time for the sound to reach full level.                       | 0 ms – 32 s  |
| Release    | Length of time for the sound to dissipate when the note is released.    | 0 ms – 32 s  |
| Vel > Amp  | The amount of effect velocity has on amplitude control.                 | 0–100%   |
| MW Vib     | Amount of vibrato applied from the mod wheel.                           | 0–100%   |
| AT Vib     | Amount of vibrato applied from aftertouch.                              | 0–100%   |
| Vib Speed  | Modulation speed of the vibrato effect.                                 | 0.03 – 30.00 Hz  |
| Key On     | Enables or disables key action noise on note on.                        | Off, On  |
| Key Off    | Enables or disables key action noise on note off.                       | Off, On  |
| On Vol     | Amount of key-on noise.   | 0–100%   |
| Off Vol    | Amount of key-off noise.  | 0–100%   |
| Smpl Poly  | Number of voices available.   | 1–40   |
| Level      | Overall level of the plugin.  | 0–100%   |

**AIR Mellotron** (continued)

**Flavor / Compressor / EQ**

Use this tab to adjust the settings for the flavor, compressor and EQ effects. Each effect can be turned on and off by using the buttons on the right side.



| Parameter        | Description   | Value Range            |
|------------------|---|------------------------|
| Flavor           | Use the button in the upper-right corner to enable or disable the flavor effect.      | Off, On                |
| Timbre           | Selects an emulation type to color the sound.   | Varies                 |
| Timbre Depth     | Amount of timbre emulation applied to the sound.                                      | 0–100%                 |
| Flutter          | Amount of speed fluctuation of the sound playback.                                    | 0–100%                 |
| Vinyl Distortion | Amount of vinyl distortion noise applied to the signal.                               | 0–100%                 |
| Vinyl Noise      | Amount of vinyl noise such as clicks and pops applied to the signal.                  | 0–100%                 |
| Compressor       | Use the button in the upper-right corner to enable or disable the compression effect. | Off, On                |
| Threshold        | Signal level after which the compressor will be applied.                              | -30.0 – 0.0 – +10.0 dB |
| Ratio            | Amount of compression applied.  | 1.0:1 – 20.0:1         |
| Attack           | Length of time to apply the compression.  | 0–100%                 |
| Makeup           | Amount of additional output gain for the compressed signal.                           | -20.0 – 0.0 – +20.0 dB |
| EQ               | Use the button in the upper-right corner to enable or disable the EQ effect.          | Off, On                |
| Low              | Amount of attenuation or boost applied to the low frequency band.                     | -12.0 – 0.0 – +12.0 dB |
| Low Mid          | Amount of attenuation or boost applied to the low-mid frequency band.                 | -20.0 – 0.0 – +20.0 dB |
| High Mid         | Amount of attenuation or boost applied to the high-mid frequency band.                | -20.0 – 0.0 – +20.0 dB |
| High             | Amount of attenuation or boost applied to the high frequency band.                    | -12.0 – 0.0 – +12.0 dB |

**AIR Mellotron** (continued)

**Delay / Spring Reverb**

Use this tab to adjust the settings for the delay and spring reverb effects. Each effect can be turned on and off by using the buttons on the right side.



| Parameter      | Description   | Value Range               |
|----------------|---|---------------------------|
| Delay          | Use the button in the upper-right corner to enable or disable delay.  | Off, On                   |
| Time           | Amount of time between the dry signal and the delayed signal.   | 1/16 – 16/4               |
| L/R Ratio      | Reduces the delay <b>Time</b> in either the <b>Left</b> or <b>Right</b> stereo field. This is useful for creating offset, panned delays.                                    | 50:100 – 100:100 – 100:50 |
| Feedback       | Amount of signal fed back into the delay line.  | 0–100%                    |
| Mix            | Wet/dry amount of the delay effect.   | 0–100%                    |
| Reso LP Freq   | Low pass frequency for feedback resonance.  | 100 – 16000 Hz            |
| Reso Bell Freq | Center frequency for feedback resonance.  | 100 – 16000 Hz            |
| Reso Bell Gain | Amount of gain applied to the resonant frequency.   | 0–100%                    |
| Spring Reverb  | Use the button in the upper-right corner to enable or disable the spring reverb effect.   | Off, On                   |
| Pre-Delay      | Length of time between dry signal and reverberated signal.  | 0 – 250 ms                |
| Time           | Length of reverb tail.  | 1.00 – 10.00 s            |
| Low Cut        | Center frequency for reverb signal low-cut filter.  | 20 – 1000 Hz              |
| Diffusion      | Rate of increasing density of reverb reflections. At lower settings, the sound of individual reflections is more present. At higher settings, reflections are more uniform. | 0–100%                    |
| Width          | Stereo width of reverb signal. Higher values give wider stereo separation.  | 0–100%                    |
| Mix            | Wet/dry amount of the reverb effect.  | 0–100%                    |



### AIR Solina

The AIR Solina plugin is a software recreation of the classic string synthesizer.



### Ensemble

Use this tab to adjust the voice and ensemble settings.

| Parameter     | Description   | Value Range   |
|---------------|---|---|
| Voice         | Click each button to enable or disable the selected voice.  | Contra Bass, Cello, Viola, Violin, Trumpet, Horn                        |
| Voice Volume  | Volume of the selected voice.   | -Inf – 0 – +12  |
| Voice Panning | Stereo panning of the selected voice.   | L64 – C – R64   |
| Voice Octave  | Octave adjustment for the selected voice.   | -2, -1, 0 (Contra Bass)<br>0, +1, +2 (Violin)<br>-1, 0, +1 (All others) |
| Ensemble      | Enables or disables the ensemble effect.  | Off, On   |
| Bass Volume   | Adjusts the volume of the bass voices.  | 0–100   |
| Dual          | When enabled, both bass and upper voices will play on every key, regardless of the octave. When disabled, the voices will be split so that the bass voices play on lower octaves and the upper voices play on higher octaves. | Off, On   |
| Upper Volume  | Adjusts the volume of the upper voices.   | 0–100   |
| Level         | Overall level of the plugin.  | 0–100%  |

**AIR Solina** (continued)

**Sound**

Use this tab to adjust additional settings for the plugin sound.



| Parameter       | Description  | Value Range   |
|-----------------|--|---------------|
| Crescendo       | Length of time for the sound to reach full volume.                             | 0 ms – 32 s   |
| Sustain         | Length of time for the sound to remain playing after the key is released.      | 0 ms – 32 s   |
| Formant         | Decreases or increases resonant frequencies to adjust the timbre of the sound. | -12 – 0 – +12 |
| Filter          | Adjusts the low-pass filter frequency.   | 0–100%        |
| Age             | Amount of detuning and drift applied.  | 0–100%        |
| Velocity to Amp | The amount of effect velocity has on amplitude control.                        | 0–100%        |
| MW Vibrato      | Amount of vibrato applied from the mod wheel.                                  | 0–100%        |
| AT Vibrato      | Amount of vibrato applied from aftertouch.                                     | 0–100%        |
| Vibrato Speed   | Modulation speed of the vibrato effect.  | 1.00–30.00 Hz |
| Sample Poly     | Number of voices available.  | 1–50          |

**AIR Solina** (continued)

**Flavor**

Use this tab to adjust the settings for the flavor and vinyl effects.



| Parameter        | Description  | Value Range |
|------------------|--|-------------|
| Flavor           | Enables or disables the flavor effect.                               | Off, On     |
| Timbre           | Selects an emulation type to color the sound.                        | Varies      |
| Timbre Depth     | Amount of timbre emulation applied to the sound.                     | 0–100%      |
| Vinyl Distortion | Amount of vinyl distortion noise applied to the signal.              | 0–100%      |
| Vinyl Noise      | Amount of vinyl noise such as clicks and pops applied to the signal. | 0–100%      |
| Flutter          | Amount of speed fluctuation of the sound playback.                   | 0–100%      |
| Monofy           | Reduces the stereo spread.   | 0–100%      |

**AIR Solina** (continued)

**Chorus / EQ**

Use this tab to adjust the settings for the chorus and EQ effects. Use the buttons on the right side to enable or disable each effect.

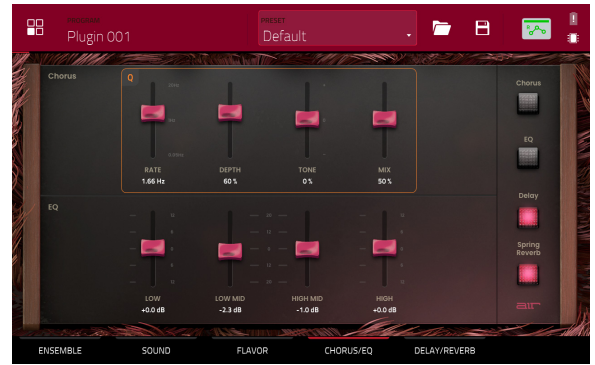

| Parameter | Description | Value Range  |                        |
|-----------|-------------|--|------------------------|
| Chorus    | Rate        | Modulation speed of the chorus effect.                                 | 0.05 – 20 Hz           |
|           | Depth       | Modulation depth of the chorus effect.                                 | 0–100%                 |
|           | Tone        | Decreases or increases the brightness of the chorus effect.            | -100 – 0 – +100%       |
|           | Mix         | Wet/dry amount of the chorus effect.                                   | 0–100%                 |
| EQ        | Low         | Amount of attenuation or boost applied to the low frequency band.      | -12.0 – 0.0 – +12.0 dB |
|           | Low Mid     | Amount of attenuation or boost applied to the low-mid frequency band.  | -20.0 – 0.0 – +20.0 dB |
|           | High Mid    | Amount of attenuation or boost applied to the high-mid frequency band. | -20.0 – 0.0 – +20.0 dB |
|           | High        | Amount of attenuation or boost applied to the high frequency band.     | -12.0 – 0.0 – +12.0 dB |

AIR Solina (continued)

**Delay / Spring Reverb**

Use this tab to adjust the settings for the delay and spring reverb effects. Use the buttons on the right side to enable or disable each effect.



| Parameter     |           | Description   | Value Range               |
|---------------|-----------|---|---------------------------|
| Delay         | Time      | Amount of time between the dry signal and the delayed signal.   | 1/16 – 16/4               |
|               | L/R Ratio | Reduces the delay <b>Time</b> in either the <b>Left</b> or <b>Right</b> stereo field. This is useful for creating offset, panned delays.  | 50:100 – 100:100 – 100:50 |
|               | Feedback  | Amount of signal fed back into the delay line.  | 0–100%                    |
|               | LP Freq   | Low pass frequency for feedback resonance.  | 100 – 16000 Hz            |
|               | Bell Freq | Center frequency for feedback resonance.  | 100 – 16000 Hz            |
|               | Bell Gain | Amount of gain applied to the resonant frequency.   | 0–100%                    |
|               | Mix       | Wet/dry amount of the delay effect.   | 0–100%                    |
| Spring Reverb | Pre-Delay | Length of time between dry signal and reverberated signal.  | 0 – 250 ms                |
|               | Time      | Length of reverb tail.  | 1.00 – 10.00 s            |
|               | Low Cut   | Center frequency for reverb signal low-cut filter.  | 20 – 1000 Hz              |
|               | Diffusion | Rate of increasing density of reverb reflections.<br>At lower settings, the sound of individual reflections is more present.<br>At higher settings, reflections are more uniform. | 0–100%                    |
|               | Width     | Stereo width of reverb signal. Higher values give wider stereo separation.  | 0–100%                    |
|               | Mix       | Wet/dry amount of the reverb effect.  | 0–100%                    |

## WayOutWare Odyssey

The WayOutWare Odyssey plugin is a software recreation of the classic analog synthesizer that captures the character and nuance of the original Odyssey using WayOutWare’s experience and expertise in circuit modeling and signal processing.

### VCO 1/2

Use this tab to adjust the settings for the voltage controlled oscillators.

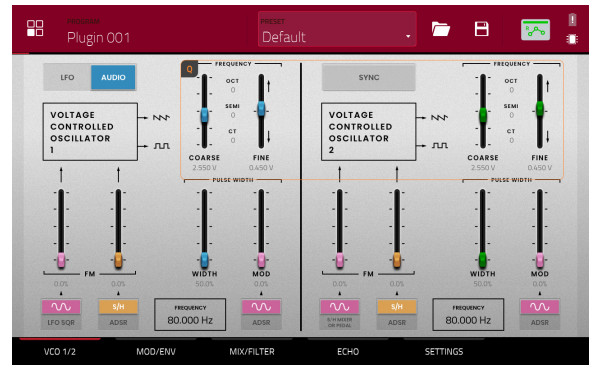

| Parameter         |                   | Description   | Value Range                  |
|-------------------|-------------------|---|------------------------------|
| LFO/Audio         |                   | When set to <b>Audio</b> , standard pitches will be produced as indicated by the <b>Oct</b> , <b>Semi</b> and <b>CT</b> values for the Frequency setting.<br>When set to <b>LFO</b> , the VCO will be controlled by an LFO and may be used for modulating VCO2. | LFO, Audio                   |
| Frequency         |                   | Determines the pitch adjustment for the oscillator. The total frequency range depends on the <b>LFO/Audio</b> setting, and is shown at the bottom of this section.  | 0.174 – 1478.852 Hz          |
|                   | Coarse            | Coarse pitch adjustment.  | -0.200 – 6.333 V             |
|                   | Fine              | Fine pitch adjustment.  | 0.000 – 0.875 V              |
| VCO 1 FM          | Source 1 Waveform | Type of frequency modulation waveform applied by the LFO.   | LFO Sine, LFO Square         |
|                   | Depth 1           | Depth of frequency modulation.  | 0.0–100.0%                   |
|                   | Source 2          | Determines the frequency modulation source.   | S/H, ADSR                    |
|                   | Depth 2           | Depth of Source 2 modulation.   | 0.0–100.0%                   |
| VCO 1 Pulse Width | Width             | Width of pulse width modulation.  | 50.0–90.0%                   |
|                   | Mod               | Depth of pulse width modulation.  | 0.0–100.0%                   |
|                   | Source            | Determines the pulse width modulation source.   | LFO Sine, ADSR               |
| Sync              |                   | Determines whether VCO 2 is synced with the frequency of VCO 1. When disabled, you can use both VCOs to produce separate pitches.   | Off, On                      |
| Frequency         |                   | Pitch adjustment for the oscillator.  | 8.706 – 1478.852 Hz          |
|                   | Coarse            | Coarse pitch adjustment.  | -0.200 – 6.333 V             |
|                   | Fine              | Fine pitch adjustment.  | 0.000 – 0.875 V              |
| VCO 2 FM          | Source 1          | Type of modulation source. When S/H Mixer or Pedal is selected, the modulation can be controlled by the Sample and Hold mixer or by an optional external expression pedal.  | LFO Sine, S/H Mixer or Pedal |
|                   | Depth 1           | Depth of Source 1 modulation.   | 0.0–100.0%                   |
|                   | Source 2          | Type of modulation source.  | S/H, ADSR                    |
|                   | Depth 2           | Depth of Source 2 modulation.   | 0.0–100.0%                   |
| VCO 2 Pulse Width | Width             | Width of pulse width modulation.  | 50.0–90.0%                   |
|                   | Mod               | Depth of pulse width modulation.  | 0.0–100.0%                   |
|                   | Source            | Type of source for pulse width modulation.  | LFO Sine, ADSR               |

WayOutWare Odyssey (continued)

Mod/Env

Use this tab to adjust the settings for the low frequency oscillator, sample and hold generator, and envelope generator.

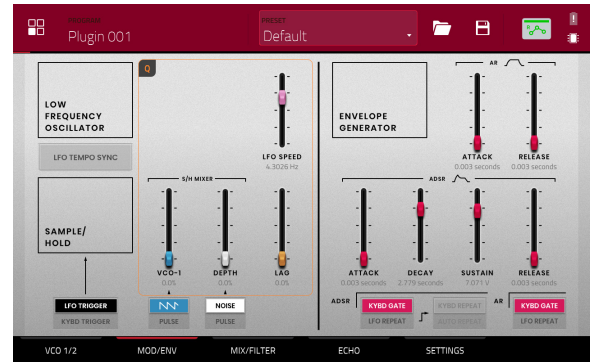

| Parameter   |                | Description  | Value Range               |
|-------------|----------------|--|---------------------------|
| LFO         | LFO Tempo Sync | Determines whether LFO speed is free floating or synced to project tempo.  | Off, On                   |
|             | LFO Speed      | Speed of the low frequency oscillator.<br>When <b>Sync</b> is <b>Off</b> : 0.0925 – 20.0000 Hz<br>When <b>Sync</b> is <b>On</b> : 4/4 – 1/64 beats   |                           |
| Sample/Hold | Trigger        | Determines the source signal for triggering the Sample and Hold mixer, either the Low Frequency Oscillator or the pitched Keyboard output.   | LFO Trigger, Kybd Trigger |
|             | Source 1       | Selects the VCO-1 waveform or pulse width modulation as Sample and Hold input.   | Saw, Pulse                |
|             | Source 2       | Selects a noise generator or the VCO-2 pulse width modulation as Sample and Hold input.  | Noise, Pulse              |
|             | VCO-1          | Level of the VCO-1 input.  | 0.0–100.0%                |
|             | Depth          | Level of the noise or VCO-2 input.   | 0.0–100.0%                |
|             | Lag            | Adjusts the smoothing of the Sample and Hold output voltage.   | 0.0–100.0%                |
| AR          | Attack         | Attack time of the AR envelope generator.  | 0.003 – 10.000 seconds    |
|             | Release        | Release time of the AR envelope generator.   | 0.003 – 10.000 seconds    |
|             | Trigger Source | Determines the input source sent to the AR envelope generator.<br>When set to <b>KYBD Gate</b> , the envelope generator is triggered by key input.<br>When set to <b>LFO Repeat</b> , the envelope generator is triggered by the LFO pulse wave. | KYBD Gate, LFO Repeat     |
| ADSR        | Attack         | Attack time of the ADSR envelope generator.  | 0.003 – 10.000 seconds    |
|             | Decay          | Decay time of the ADSR envelope generator.   | 0.003 – 10.000 seconds    |
|             | Sustain        | Sustain time of the ADSR envelope generator.   | 0.000 – 10.000 V          |
|             | Release        | Release time of the ADSR envelope generator.   | 0.003 – 10.000 seconds    |
|             | Trigger Source | Type of input to trigger the envelope generator.   | KYBD Gate, LFO Repeat     |
|             | Repeat         | When <b>Trigger Source</b> is set to <b>LFO Repeat</b> , select <b>KYBD Repeat</b> for the LFO to trigger only when a key is pressed, or select <b>Auto Repeat</b> for the LFO to trigger automatically without key input.                       | KYBD Repeat, Auto Repeat  |

WayOutWare Odyssey (continued)

Mix/Filter

Use this tab to adjust the audio mixing and routing, as well as adjust the voltage controlled filter, high-pass filter, and voltage controlled amplitude.

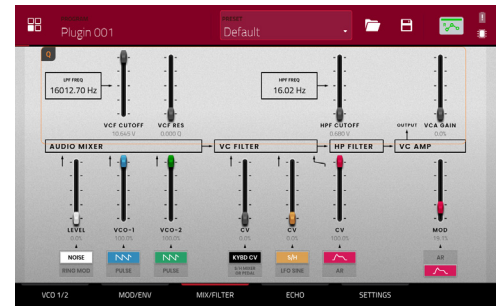

| Parameter   | Description                    | Value Range  |
|-------------|--------------------------------|--|
| VCF         | VCF Cutoff                     | Cutoff frequency of the filter.<br>0.680 – 10.645 V, or<br>16.02 - 16012.70 Hz   |
|             | VCF Res                        | Resonance of the filter.<br>0.000 – 0.800 Q  |
| Audio Mixer | Noise/Ring Mod                 | Select the noise generator or ring modulation input for the mixer.<br>Noise, Ring Mod  |
|             | Noise/Ring Mod Level           | Level of the noise generator or ring modulation into the mixer.<br>0.0–100.0%  |
|             | VCO-1 Input                    | Select the VCO-1 input type for the mixer.<br>Saw, Pulse   |
|             | VCO-1 Level                    | Level of VCO-1 into the mixer.<br>0.0–100.0%   |
|             | VCO-2 Input                    | Select the VCO-2 input type for the mixer.<br>Saw, Pulse   |
|             | VCO-2 Level                    | Level of VCO-2 into the mixer.<br>0.0–100.0%   |
| VC Filter   | VCO-1 Filter Modulation Source | Set the input source for VCO-1 filter modulation.<br>Select <b>KYBD CV</b> to use key input as the source.<br>Select <b>S/H Mixer or Pedal</b> to use the Sample and Hold generator or optional external pedal.<br>KYBD CV, S/H Mixer or Pedal |
|             | CV Modulation Level            | Level of VCO-1 filter modulation.<br>0.0–100.0%  |
|             | VCO-2 Filter Modulation Source | Set the input source for VCO-2 filter modulation.<br>S/H, LFO Sine   |
|             | CV Modulation Level            | Level of VCO-2 filter modulation.<br>0.0–100.0%  |
| HP Filter   | Filter Modulation Source       | Select which envelope generator to use as a filter modulation source.<br>ADSR, AR  |
|             | CV Filter Modulation Level     | Amount of envelope filter modulation applied to the VC Filter.<br>0.0–100.0%   |
|             | HPF Cutoff                     | Cutoff frequency of the high-pass filter.<br>0.680 – 10.645 V, or<br>16.02 - 16012.70 Hz   |
| VC Amp      | Mod Source                     | Select which envelope generator to use as an amplitude modulation source.<br>ADSR, AR  |
|             | Mod                            | Amount of envelope modulation applied to the output signal.<br>0.0–100.0%  |
|             | VCA Gain                       | Amount of gain applied to the VC Amp.<br>0.0–100.0%  |



WayOutWare Odyssey (continued)

**Echo**

Use this tab to adjust the settings for the tape echo effect.

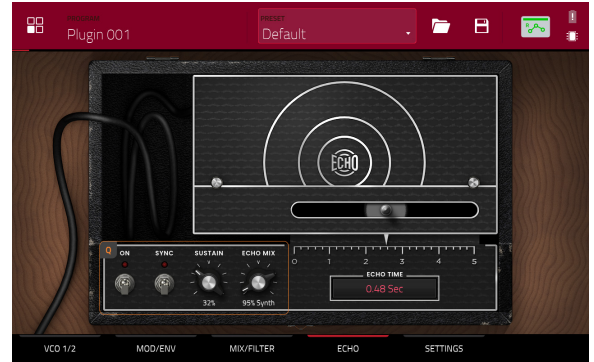

| Parameter | Description   | Value Range  |
|-----------|---|--|
| Delay     | Use the switch in the bottom-left corner to enable or disable the delay effect.   | Off, On  |
| Sync      | Enable to sync the <b>Echo Time</b> to the <b>Global Tempo</b> , or disable to adjust the <b>Echo Time</b> by milliseconds. | Off, On  |
| Sustain   | Length of time that the echo continues playing.   | 0.0–100.0%   |
| Echo Mix  | Adjusts the wet/dry amount between the original sound and the echo.   | 100% Synth – 50/50% – 100% Echo  |
| Echo Time | Amount of time between the dry signal and the delayed signal. Use the slider or the Echo Time field to change the value.    | When <b>Sync</b> is <b>Off</b> : 0.02 – 5.00 seconds<br>When <b>Sync</b> is <b>On</b> : 1/64 – 4/4 |

WayOutWare Odyssey (continued)

Settings

Use this tab to adjust general settings such as voice count, portamento and performance parameters.

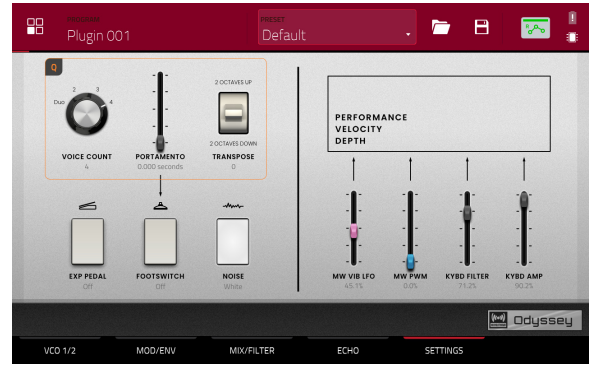

| Parameter                  | Description   | Value Range   |            |
|----------------------------|---|---|------------|
| Voice Count                | Number of voices available. When set to Duo, each VCO controls a separate note. | Duo, 2–4  |            |
| Portamento                 | Length of time to slide between notes.  | 0.000 – 1.500 seconds   |            |
|                            | Exp Pedal   | Enables or disables the use of an expression pedal to control portamento. | Off, On    |
|                            | Footswitch  | Enable or disables the use of a footswitch to activate portamento.        | Off, On    |
| Transpose                  | Amount of transposition applied to the keyboard.                                | -2, 0, +2 octaves   |            |
| Noise                      | Type of noise used for the noise generator.                                     | White, Pink   |            |
| Performance Velocity Depth | MW Vib LFO  | Amount of vibrato LFO applied by the mod wheel.                           | 0.0–100.0% |
|                            | MW PWM  | Amount of pulse width modulation applied by the mod wheel.                | 0.0–100.0% |
|                            | KYBD Filter   | Amount that the filter is tied to the pitch being played.                 | 0.0–100.0% |
|                            | KYBD Amp  | Amount that the amplitude is tied to the pitch being played.              | 0.0–100.0% |

## AIR FX Bundle

Your MPC hardware now includes nine new insert effects, including a new AIR vocal effects suite, an improved AIR Diffuser Delay, and more.

### AIR Diff Delay

This is a delay line effect that is synchronized to your session tempo and uses an adjustable amount of diffusion to emulate the dissipation of echoes in reverberant space.

| Parameter       | Value Range   | Default Value |
|-----------------|---|---------------|
| Time            |   |               |
| Sync Off:       | 1 – 1000 ms   | 161 ms        |
| Sync On:        | 1/64 – 4/4<br>(including Triplet<br>and Dotted<br>variations) | 1/16D         |
| Sync            | Off, On   | On            |
| Width           | 0–100%  | 100%          |
| Mix             | 0–100% (dry–wet)  | 40%           |
| Feedback        | 0–100%  | 50%           |
| Fdbk. Diffusion | 0–100%  | 40%           |
| Fdbk. High Damp | 0–100%  | 35%           |
| Low Cut         | 20.0 Hz – 1.00<br>kHz   | 20.0 Hz       |
| Pan             | -100 – 0 – +100%  | 0%            |

### AIR Diode Clip

This is a distortion effect that can be used for anything from adding subtle grit to drum breaks to aggressive distorted mayhem.

| Parameter    | Value Range           | Default Value |
|--------------|-----------------------|---------------|
| Input HP     | 200 – 800 Hz          | 500 Hz        |
| Env Speed    | 0–100%                | 50%           |
| Output HP    | 1000 – 4000 Hz        | 2000 Hz       |
| Output LP    | 1000 – 12000 Hz       | 6000 Hz       |
| Wide         | Off, On               | Off           |
| Solo         | Off, On               | Off           |
| Oversampling | Off, On               | On            |
| Level        | -inf – 0.0 – +12.0 dB | 0.0 dB        |

### AIR Half Speed

This effect can quickly create half-speed versions from any input material. Filter the processed audio using the built-in high pass and low pass filter to create dramatic transitions, and use the fade in and fade out parameters to create synchronized transitions between dry and effected audio.

| Parameter   | Value Range             | Default Value |
|-------------|-------------------------|---------------|
|             | Start, Stop             |               |
| Loop Length | 1/16 – 4 Bars           | 1 Bar         |
| Mode        | *1.5, *2, *4            | *2            |
| Mix         | 0–100%                  | 100%          |
| Loop Fade   | 1.00 – 200 ms           | 4.90 ms       |
| Fade In     | Hard, Soft, 1/16–4 Bars | Hard          |
| Fade Out    | Hard, Soft, 1/16–4 Bars | Hard          |
| HPF         | Off, 20.0 Hz – 20.0 kHz | Off           |
| LPF         | 20.0 Hz – 19.9 kHz, Off | Off           |
| Band        | Off, On                 | Off           |

### AIR Limiter

This is a lookahead limiter perfect for mastering or mixing.

| Parameter  | Value Range        | Default Value |
|------------|--------------------|---------------|
| Gain       | -12.0 – 36.0 dB    | 0.0 dB        |
| Ceiling    | -24.0 – 0.0 dB     | 0.0 dB        |
| Look Ahead | 0.0 – 20.0 ms      | 0.0 ms        |
| Release    | 10.0 ms – 10.0 s   | 316 ms        |
| LF Mono    | 10.0 Hz – 1.00 kHz | 10.0 Hz       |

### AIR Stutter

This effect creates mind-blowing glitch effects using a wide range of volume, pan and pitch stutter effects.

| Parameter   | Value Range          | Default Value |
|-------------|----------------------|---------------|
| Intervals   | 1/64 – 1/4           | 1/16          |
| Sync        | Off, On              | On            |
| Steps       | 2–64                 | 5             |
| Step Length | 0–100%               | 100%          |
| Freeze      | Off, On              | Off           |
| Decay       | 50.0 ms – 100 s      | 6.99 s        |
| Volume      | -12.0 – 0.0 – 6.0 dB | -1.2 dB       |
| Mix         | 0–100%               | 100%          |
| Pan Mod     | 0–100%               | 50%           |
| Pitch Mod   | -100 – 0 – +100%     | 0%            |

MPC now also includes a new AIR Vocal insert effects suite, designed to enhance working with voices in MPC.

### AIR Vocal Doubler

This effect creates realistic vocal doubles to add width or thickness to a vocal line.

| Parameter      | Value Range    | Default Value |
|----------------|----------------|---------------|
| Voices         | 1–8            | 4             |
| Stereo Spread  | 0–100%         | 70%           |
| Lead Volume    | -Inf – +6.0 dB | 0.0 dB        |
| Doubler Volume | -Inf – +6.0 dB | 0.0 dB        |
| Pitch          | +/- 0–250%     | +/- 38%       |
| Pitch Speed    | 0–100%         | 75%           |
| Timing         | 0–800 ms       | 63 ms         |

### AIR Vocal Harmonizer

This effect can create up to four-part realistic vocal harmonies and complex doubling effects. Each vocal part has its own level, delay, formant, mode and interval parameters.

| Parameter       | Value Range   | Default Value |
|-----------------|---|---------------|
| Key             | A–G#  | C             |
| Scale           | Major, Minor, Harm Minor, Melo Minor, Dorian, Phrygian, Lydian, Mixo, Locrian, Chromatic, Penta, Maj Triad, Min Triad, Root | Major         |
| Lead Volume     | -Inf – 0.0 dB   | 0.0 dB        |
| Harmony Volume  | -Inf – 0.0 dB   | -2.5 dB       |
| Timing          | 0–100%  | 42%           |
| Tuning          | 0–100%  | 14%           |
| Smooth          | 5–200 ms  | 8 ms          |
| Voice Range     | Very Low, Low, Mid, Mid High, Very High   |               |
| Root Mode Split | A–G#  | E             |
| Reference       | 420.0–460.0 Hz  | 440.0 Hz      |
| Delay Sync      | Off, On   | On            |
| Harmony 1–4     | Off, On   | 1 On          |

## AIR Vocal Tuner

This effect applies pitch correction for natural sounding or hard-tuned vocal effects.

| Parameter   | Value Range   | Default Value |
|-------------|---|---------------|
| Detection   | Unworried, Default, Selective, Picky, Blind   | Default       |
| Voice Range | Very Low, Low, Mid, High, Very High   | Mid           |
| Key         | A–G#  | A             |
| Scale       | Major, Minor, Harm Minor, Melo Minor, Dorian, Phrygian, Lydian, Mixo, Locrian, Chromatic, Penta, Maj Triad, Min Triad, Root | Minor         |
| Retune Time | 1–1000 ms   | 32 ms         |
| Reference   | 420.0–460.0 Hz  | 440.0 Hz      |

Two new Akai insert effects are also included:

## Sample Delay

This effect is a utility delay plugin that can delay the left and right channels by different, small amounts to loosen percussion elements or add stereo width.

| Parameter    | Value Range                           | Default Value             |
|--------------|---------------------------------------|---------------------------|
| Left / Right | 0–11025 Samples<br>or<br>0.0–250.0 ms | 0 Samples<br>or<br>0.0 ms |
| Samples / MS | Samples, MS                           | Samples                   |
| Link         | Off, On                               | Off                       |

## Granulator

This effect turns your incoming audio into small grains of sound that can be looped, pitch shifted, and manipulated in new and interesting ways.

| Parameter             | Value Range                  | Default Value   |
|-----------------------|------------------------------|-----------------|
| Grain Density         | 1.0–300.0 grains/sec         | 68.0 grains/sec |
| Grain Window          | 20.0–1000.0 ms               | 608.0 ms        |
| Grain Length          | 10.0–200.0 ms                | 171.9 ms        |
| Grain Feedback        | -99.9 – 0.0 – 99.9%          | 0.0%            |
| Trigger Randomization | 0–100%                       | 0.0%            |
| Pitch Randomization   | 0–100%                       | 0.0%            |
| Pitch                 | -12.0 – 0.0 – 12.0 semitones | 0.0 semitones   |
| Fine                  | -50.0 – 0.0 – 50.0%          | 0.0%            |
| Stereo                | 0–100%                       | 0.0%            |
| Mix                   | 0–100%                       | 34.6%           |
| Freeze                | Off, On                      | Off             |

## Standalone Audio Interface Support

You can now use most audio interfaces that are both USB class-compliant and Linux class-compliant with your standalone MPC. Audio devices must also be set to 44.1 kHz sample rate and 128 sample buffer size.

**Note:** If you are unsure of your audio interface's compatibility, check with the original equipment manufacturer for more information.

### To use an external audio interface:

1. Open the **Menu** and tap the **gear icon** to open the Preferences.
2. Select the **Audio Device** settings from the sidebar.
3. Use the **Audio Device** field to select the **Internal** sound device or a connected, class-compliant audio interface. Check the **32 Inputs/Outputs** box to enable use of up to 32 simultaneous inputs and outputs.

**Note:** Increasing the number of simultaneous inputs and outputs will also increase CPU overhead.

## FX Racks

You can now load and save FX racks with your MPC hardware. An FX rack is a preset file containing all parameter settings of up to four insert effects on a single channel strip. A factory library of FX Rack presets are also included, divided into helpful categories such as Drums and Percussion, Voice, Guitar, Experimental, Mastering, and more.

**To load or save an FX rack**, open any Inserts page (such as in the Program Edit, Channel Mixer or Pad Mixer modes):

Tap the **Akai folder icon** to load one of the included factory presets.

Tap the **FX folder icon** to load a previously saved custom preset file.

Tap the **disk icon** to save all settings from all Insert effects in the channel strip to a single file.

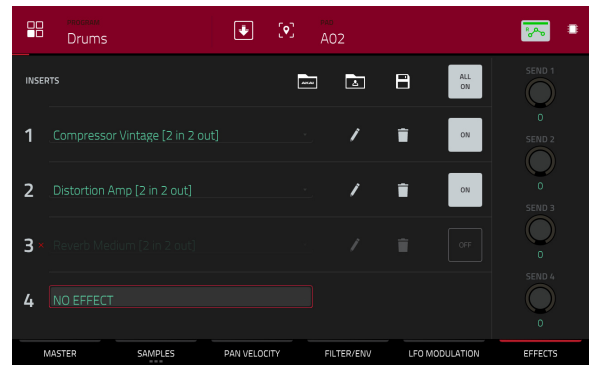

## Drum and Keygroup Program Improvements

Drum and Keygroup programs have been significantly reworked to add more features and improve the ergonomics of the editors. The Program Edit interface has been improved overall, and many new features have been added.

### Sample Tail

Drum Programs now include a **Tail Length** and **Tail Start** parameters for adding extra audio tail to any chopped sample. This is useful for things like making an abrupt end to a sample sound more natural or adding experimental looping effects to a sample.

#### To adjust the tail of a sample:

1. Load a Drum or Keygroup Program.
2. Press **Menu**, and then tap **Program Edit** to open Program Edit mode.
3. Tap the **Samples** tab to open the first page.
4. Use the **Tail Length** parameter to enable the sample tail and set its length.
5. Use the **Tail Start** parameter to set the starting point of the tail for looping. Set this to smaller values for delay effects, or longer values for more obvious looping effects.

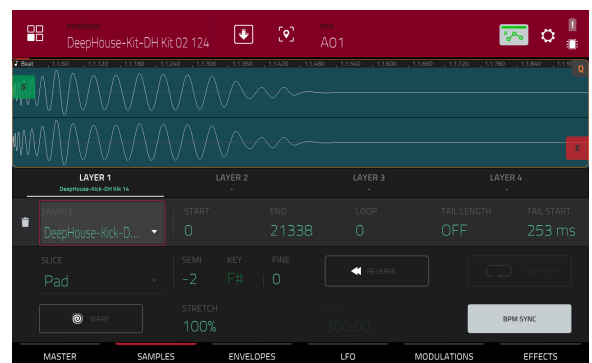

## Drum FX

You can now quickly add effects to samples in a Drum program by using the built-in Drum FX

### To use the Drum FX:

1. Load a Drum Program.
2. Press **Menu**, and then tap **Program Edit** to open Program Edit mode.
3. Tap the **Effects** tab twice to open the second page.
4. There are eight available Drum FX slots, each with an adjustable parameter:
  - Ring Mod
  - Bit Crush
  - Decimator
  - Tube Drive
  - Soft Clipper
  - Hard Clipper
  - Low Pass
  - High Pass
  - Rectifier
  - Bass Enhancer (Tight)
  - Bass Enhancer (Medium)
  - Bass Enhancer (Wide)
  - Stereo Width
  - Wave Folder
  - Gain
5. Use the **Type** dropdown menu to select the effect in each slot and turn each knob to adjust the selected effect parameter.



## Randomization

Drum and Keygroup programs now have a **Randomization** section. You can use this section to add subtle variation to drum samples or keygroup programs by randomizing parameters.

### To adjust the Randomization parameters:

1. Load a Drum or Keygroup program.
2. Press **Menu**, and then tap **Program Edit** to open Program Edit mode.
3. Tap the **Samples** tab until you reach the fourth page.
4. Use the knobs to adjust the available randomization parameters for each layer: **Pitch**, **Level**, **Pan**, **Sample Offset**, and **Envelope** (Attack, Decay, Cutoff, Resonance).

Use the **Depth** slider to control the amount of randomization applied overall.



## Other Enhancements

Drum and Keygroup programs now have adjustable curve parameters for each time stage.

Drum and Keygroup programs now have an adjustable **Pitch** envelope.

Drum and Keygroup programs now have **Note-Off** as an available option for the Sample Play triggering parameter.

Keygroup Programs now have **Portamento**, **Time**, **Quantize**, and **Legato** parameters that can be controlled through program automation. These can also be accessed in **Program Edit** mode in the **Porta/Mod** tab.



## File Browser Enhancements

The MPC File Browser now supports recursive searching. When searching for files, enter a search term and by default MPC will search for files that match the search term in the current and all available subfolders. To disable this, click the Settings icon next to the Search bar and uncheck

You can now view the **Size**, **Date Created**, and **Date Modified** for each file in the File Browser. Tap the **gear icon** below the Search bar to open the Browser settings window, and then tap to enable the options you would like to view.

You can now order the File Browser by column type. Tap the column header to sort the files in ascending or descending order for the selected column.

You can now Filter the file list in the File Browser by Plugin Presets. Tap the **plug icon** in the filters list to show only plugin preset files.

You can now tap and drag samples in the **Sample Assign** tab to a drum pad. Hold **Shift** and tap and drag to add the sample to a specific layer on the pad, indicated by a red bar.

## Key Detection

MPC now automatically calculates the key of melodic samples after being loaded.

**To view the sample key**, load a sample and open it in it in Sample Edit or Program Edit modes.

## Expanded CV Program Operation

You can now set CV programs to Melodic or Drum operation. Melodic CV programs behave the same as previous MPC versions. Drum CV programs can be used to configure any pad to output on any CV port.

### To set the CV program type:

1. Load a CV program.
2. In the Program section of Main Mode, tap the Keys icon to select Melodic program, or tap the Pads icon to select Drum operation.

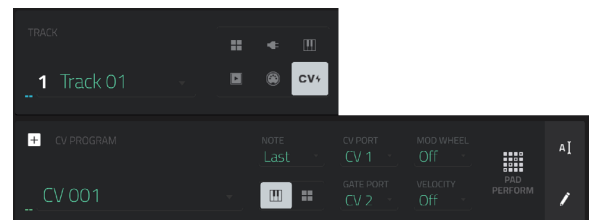

### To edit the assignments of a Drum type CV program:

1. After adding a CV Drum program, click **Edit** next to **CV Map** in the Program Inspector window.
2. In the window that appears:
  - Use the **Pad** field to select the pad to edit.
  - Use the **To Port** field to select the CV port the pad will send data on.
  - Use the **Data Type** field to select the type of data sent: Gate, Velocity, or Note.

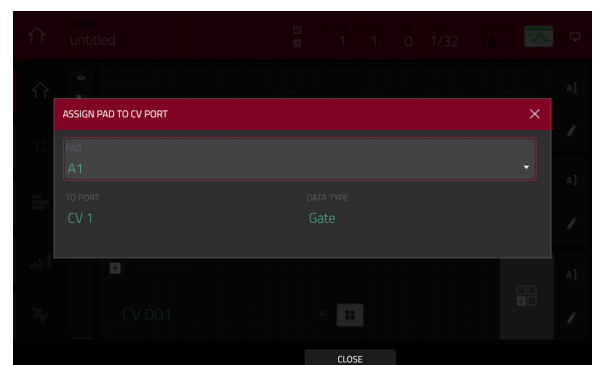

## MIDI Program Renaming

You can now rename any control in a MIDI program. This lets you save the MIDI program with renamed parameters and use it in any MPC project.

### To rename a MIDI control:

1. Select a MIDI program.
2. Press **Menu**, and then tap **Program Edit** to open Program Edit mode.
3. Tap the **Edit** button at the top of the screen.
4. Tap the MIDI Control dropdown menu to select the MIDI assignment for each control.
5. Tap the **pencil icon** to edit the name of the selected control using the keyboard that appears.

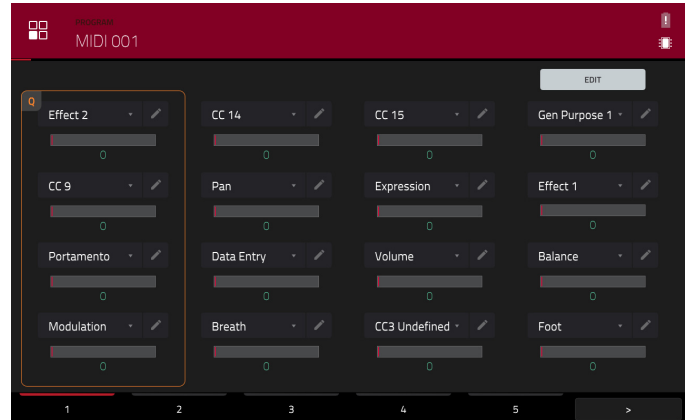

## MIDI Monitor

You can now monitor incoming MIDI messages using the built-in MIDI monitor.

**To view incoming MIDI data**, tap the **MIDI In/Out icons** in the Main Mode or Menu toolbar. The MIDI Monitor popup will display the last 10 MIDI messages sent or received.

Tap **In** to view incoming MIDI messages.

Tap **Out** to view outgoing MIDI messages.

Tap **Clear** to clear the monitor log.

Tap Close or the X to close the MIDI monitor and return to the previous page.

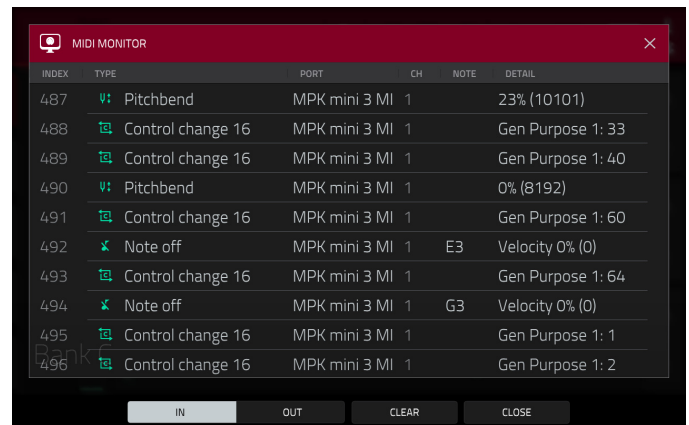

## Undo History

You can now view your **Undo History** from your MPC hardware.

**To view the Undo History window**, open the **Menu** and tap the **clock icon**. The last 10 undoable (and redoable) actions you have performed will appear in this list in sequence. Each action is named in the **Action** column with additional information in the **Detail** column.

Tap the **Undo** button to undo the last action.

Tap the **Redo** button to redo the last action you undid.

The magenta **action marker** indicates the current “undo state” location—the last-performed action.

**To undo or redo multiple actions at once**, click and drag the **action marker** to the desired location in the list. The project will immediately revert to that state. Actions that can be redone (below the action marker) are grayed out.

Tap **Close** or the **X** to close the Undo History window and return to the previous page.

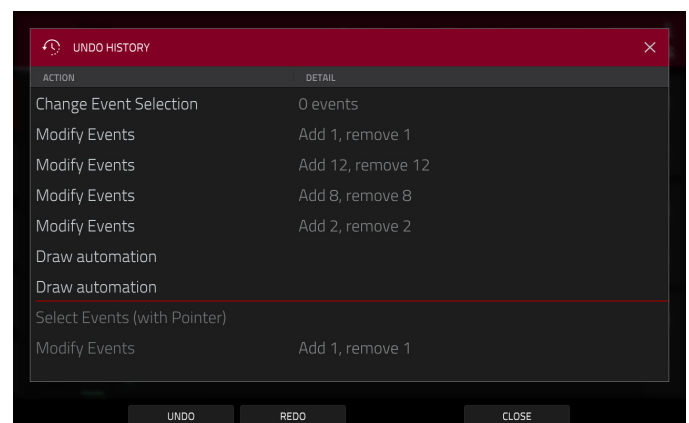

## Updates in MPC 2.10.1

### New Features

#### MPC Studio mk2 Support

MPC 2.10.1 adds support for the Akai Professional MPC Studio mk2 hardware. This hardware differs from other MPC hardware in this manual in that it acts primarily as a controller for the MPC software.

Updates in this manual will instruct you how to use your MPC Studio hardware to access various modes, parameters, and functions of the MPC software. To learn more about how to use the MPC software, consult the MPC software User Guide. This can be accessed by opening the MPC software, and then navigating in the menu to **Help > MPC Help > MPC Software Manual**.

For a breakdown of MPC Studio's controls, see [Features > MPC Studio mk2](#).

#### Touch Strip and Touch FX

MPC now supports MPC Studio's **touch strip** control, which gives you expressive control over levels, notes, and more, including the new **Touch FX** insert effects. As you move your finger along the touch strip, the current position will determine the current value of the parameter.

##### To use the touch strip with MPC Studio:

1. Press the **Touch Strip** button to enter Touch Strip mode selection.
2. Press the **Touch Strip** button again repeatedly to cycle through the available Touch Strip modes as shown on MPC Studio's display:
  - Touch FX
  - Notes
  - Pitch Bend
  - Mod Wheel
  - Sustain
  - Expression
  - Q-Link
  - Pad level
  - Program Level
  - Project

You can also use the **data dial** or **-/+** buttons to cycle through the modes while the **Touch Strip** button is activated. See below for more information on each mode.

3. Press your finger on the **touch strip** and move it up and down as an expressive control for the selected parameter.
4. Press and hold **Shift** and press the **Touch Strip** button to configure settings for each mode, if available. See below to learn more.

##### To load the Touch FX plugin from MPC hardware with a touchscreen:

1. Tap an empty slot in the **Inserts** section of any channel strip.
2. Double-tap an empty insert slot in the Effects window to open the list of plugin effects
3. Tap the **+** or **-** button to expand the **Harmonic** category.
4. Select the **TouchFX** plugin.
5. Tap the **pencil icon** to open the plugin window, where you can adjust the plugin settings and use the virtual touch strip to control the effect.

## Touch FX

Select this mode to use the touch strip as an expressive control for an effect parameter. The effect you control acts like an insert effect on the selected output.

### To configure the Touch FX settings from MPC Studio:

1. Press and hold **Shift** and press the **Touch Strip** button to open the Touch FX Setup window in the software.
2. Use the **Touch FX Destination** field to select where the Touch FX should be applied. You can select the current Program, a Return, a Submix, or an Output. Click the **Insert Touch FX** button to add Touch FX to the selected destination.
3. Once Touch FX has been inserted, you can press and hold **Shift** and press the **Touch Strip** button again to reopen the **Touch FX Setup** window in the software to configure additional settings:

**Touch FX Preset:** Use this field to select the desired effect for the touch strip. You can also use the **data dial** or **-/+** buttons to cycle through the presets as shown on the display once Touch FX has been inserted to a destination. The specific parameters for each effect can be set by clicking the **Touch FX Setup** button at the bottom of the window.

**Latch:** Check this box to keep the current position on the touch strip even after you release it. The position will remain in place until you touch another part of the XY pad or until you uncheck **Latch**.

**Touch > Wet/Dry:** Check this box to use the touch strip to control the **Wet/Dry** amount in addition to the **Assigned Parameter** as set by clicking the **Touch FX Setup** button at the bottom of the window.

**Wet/Dry:** Use this slider to set the blend the original signal (dry) and the effect signal (wet).

**Attack:** Use this slider to set the length of the attack phase of the envelope, which is triggered when you make contact with the touch strip. In other words, this determines how long it takes the effect to fully respond to your touch.

**Release:** Use this slider to set length of the release phase of the envelope, which is triggered when you release the touch strip. In other words, this determines how long it takes the effect to fully deactivate after you release your finger from the touch strip.

**Touch FX Setup:** Click this button at the bottom of the window in the software to open the effect plugin setup window to change the parameters for the selected preset.

In this window, you can also use the **Assigned Parameter** field to select a preset parameter to be controlled by the touch strip. This can be separate from or in addition to controlling the **Wet/Dry** amount, depending on the **Touch > Wet/Dry** setting.

To close the Touch FX Setup window, click **Close** in the software, or press and hold **Shift** and press the **Touch Strip** button again.

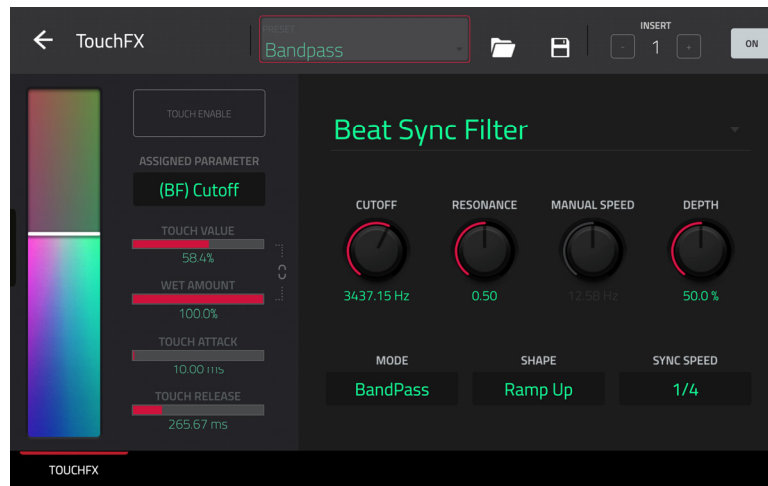

Use the controls on the left side of the Touch FX plugin window to adjust the settings for MPC Studio's **Touch Strip** control. For other hardware, you can control the Touch Strip by assigning it to a MIDI control or by using the virtual touch strip on the touchscreen.

**Touch Strip:** This strip represents the MPC Studio's **touch strip** control, and can also be controlled manually by clicking and dragging from the software, tapping and dragging from a hardware touchscreen, or by assigning it a MIDI control. Use this to control the selected Touch FX.

**Touch Enable:** Tap this box to enable touch control the currently selected Touch FX.

**Assigned Parameter:** Use this field to select a preset parameter to be controlled by the touch strip. This can be separate from or in addition to controlling the **Wet/Dry** amount, depending on the **Touch > Wet/Dry** setting.

**Touch Value:** Use this slider to control the value of the **Assigned Parameter** controlled by the **touch strip**.

**Wet Amount:** Use this slider to set the blend the original signal (dry) and the effect signal (wet).

**Touch Value / Wet/Dry Lock:** Tap the **lock icon** to use the touch strip to control the **Wet/Dry** amount in addition to the touch value of the **Assigned Parameter**.

**Touch Attack:** Use this slider to set the length of the attack phase of the envelope, which is triggered when you move the touch strip control.

**Touch Release:** Use this slider to set length of the release phase of the envelope, which is triggered when you release the touch strip control.

Use the controls on the right side of the Touch FX plugin window to select a Touch FX type and adjust its settings. You can also select from the included presets at the top of the window.

### Manual Filter

The touch strip controls a static, multi-mode filter without modulation.

| Parameter | Value Range               | Default Value |
|-----------|---------------------------|---------------|
| Cutoff    | 40.00–10000 Hz            | 2530.00 Hz    |
| Resonance | 0.00–1.00                 | 0.50          |
| Mode      | LowPass, BandPass, HiPass | LowPass       |

### Beat Sync Filter

The touch strip controls a multi-mode filter with its cutoff frequency modulated by an LFO, which can be synced to the project tempo.

| Parameter    | Value Range  | Default Value |
|--------------|--|---------------|
| Cutoff       | 40.00–10000 Hz   | 34737.15 Hz   |
| Resonance    | 0.00–1.00  | 0.50          |
| Manual Speed | Off, 0.10–50.00 Hz   | Off           |
| Depth        | 0.0–100.0%   | 50.0%         |
| Mode         | LowPass, BandPass, HiPass  | BandPass      |
| Shape        | Ramp Up, Ramp Down, Triangle, Sine, Square, Random1, Random2           | Ramp Up       |
| Sync Speed   | Off, 2 Bars, 1 Bar, 1/2, 1/4, 1/4t, 1/8, 1/8t, 1/16, 1/16t, 1/32, 1/64 | 1/4           |

### Beat Sync Delay

The touch strip controls repeated instances of the original signal that decay over a period of time that is synced to the project tempo.

| Parameter   | Value Range   | Default Value |
|-------------|---|---------------|
| Cutoff      | 40.00–10000 Hz  | 3052.90 Hz    |
| Resonance   | 0.00–1.00   | 0.50          |
| Feedback    | -99.00 – 0.00 – 99.00                                     | 49.50         |
| Diffusion   | 0.00–1.00%  | 0.50%         |
| Mode        | LowPass, BandPass, HiPass                                 | LowPass       |
| Delay Time  | 1 Bar, 1/2, 1/4, 1/4t, 1/8, 1/8t, 1/16, 1/16t, 1/32, 1/64 | 1/4           |
| Delay Mode  | Normal, Cross-Feedback, Ping-Pong                         | Normal        |
| Octave Mode | Off, On   | Off           |

### Beat Repeat

The touch strip controls an effect that will slice and repeat the source audio according to a tempo-synced beat value.

| Parameter  | Value Range                                   | Default Value |
|------------|---|---------------|
| Cutoff     | 40.00–10000 Hz                                | 2530.00 Hz    |
| Resonance  | 0.00–1.00                                     | 0.50          |
| Mode       | LowPass, BandPass, HiPass                     | LowPass       |
| Delay Time | 1/4, 1/4t, 1/8, 1/8t, 1/16, 1/16t, 1/32, 1/64 | 1/4           |
| Reverse    | Off, On                                       | Off           |

### Tape Stop

The touch strip controls a tape stop effect that emulates the slowing down of analog tape playback.

| Parameter        | Value Range  | Default Value |
|------------------|--|---------------|
| Cutoff           | 40.00–10000 Hz                                     | 2530.00 Hz    |
| Manual Stop Time | 1.00 – 4.00 s                                      | 2.50 s        |
| Sync Stop Time   | Off, 1/4, 1/4t, 1/8, 1/8t, 1/16, 1/16t, 1/32, 1/64 | Off           |

### Phaser

The touch strip controls a phaser effect, created by multiple ganged all-pass filters to create “notches,” or sharp spikes, in the frequency spectrum. The frequencies of these all-pass filters can be modulated by an LFO to create a sweeping sound.

| Parameter    | Value Range  | Default Value |
|--------------|--|---------------|
| Feedback     | 0.0–100.0%   | 100.0%        |
| Manual Speed | 0.10–50.00 Hz  | Off           |
| Sync Speed   | Off, 2 Bars, 1 Bar, 1/2, 1/4, 1/4t, 1/8, 1/8t, 1/16, 1/16t, 1/32, 1/64 | 1/4           |

### Comb Filter

The touch strip controls a comb filter, which creates “notches” in the frequency spectrum, similar to the phaser, by delaying the audio signal and adding it back to itself.

| Parameter    | Value Range  | Default Value |
|--------------|--|---------------|
| Feedback     | 0.0–100.0%   | 100.0%        |
| Manual Speed | 0.10–50.00 Hz  | Off           |
| Sync Speed   | Off, 2 Bars, 1 Bar, 1/2, 1/4, 1/4t, 1/8, 1/8t, 1/16, 1/16t, 1/32, 1/64 | 1/4           |

### Washout

The touch strip controls an echo effect that is useful for creating transitions.

| Parameter  | Value Range   | Default Value |
|------------|---|---------------|
| Cutoff     | 40.00–9000 Hz   | 1160.00 Hz    |
| Resonance  | 0.00–100.00%  | 0.50%         |
| Feedback   | 0.00–100.00%  | 0.50%         |
| Diffusion  | 0.0–10000.0%  | 5000.0%       |
| Delay Time | 1 Bar, 1/2, 1/4, 1/4t, 1/8, 1/8t, 1/16, 1/16t, 1/32, 1/64 | 1 Bar         |

## Granulator

The touch strip controls a granulator effect, which turns your incoming audio into small grains of sound that can be looped, pitch-shifted, and manipulated.

| Parameter      | Value Range             | Default Value    |
|----------------|-------------------------|------------------|
| Density        | 1.0–300.0 grains/sec    | 150.0 grains/sec |
| Window Length  | 20.0–1000.0 ms          | 510.0 ms         |
| Grain Length   | 10.0–200.0 ms           | 105.0 ms         |
| Grain Feedback | -99.00 – 0.00 – 99.00   | 0.0%             |
| Pitch          | -12.0 – 0.0 – 12.0 semi | 0.0 semi         |
| Stereo Spread  | 0.0–100.0%              | 0.0%             |

## Manual Flanger

The touch strip controls a flanger effect, a modulated delay that emulates the sound created when running two analog tape machines in parallel with a slight time misalignment.

| Parameter | Value Range       | Default Value |
|-----------|-------------------|---------------|
| Frequency | 100.00–4000.00 Hz | 4000.00 Hz    |
| Feedback  | 0.0–100.0%        | 100.0%        |

## Notes

Select this mode to use the touch strip as a control for playing notes in the selected program.

**To configure the Note settings**, press and hold **Shift** and press the **Touch Strip** button to open the Touch Strip Notes Config window in the software.

**Root Note:** Use this field to set the desired root note of the scale.

**Scale:** Use this field to set the type of scale.

**Octave:** Use this field to set the starting octave of the root note.

**Velocity:** Use this field to set the velocity of the notes played with the touch strip.

**Number of Notes:** Use this field to set the number of notes covered by the length of the touch strip.

## Pitch Bend

Select this mode to use the touch strip as you would a pitch wheel on a typical keyboard to control pitch bend.

**To configure the Pitch Bend settings**, press and hold **Shift** and press the **Touch Strip** button to open the Pitch Bend Settings window in the software.

**Relative Mode:** When checked, the center pitch is set wherever you first place your finger along the touch strip. When unchecked, the touch strip is fixed with the center being the unchanged noted.

**Bend Up Range:** Use this field to set the range of the pitch bend up in semitones.

**Bend Down Range:** Use this field to set the range of the pitch bend down in semitones.

**Note:** Pitch Bend ranges are only applied to MPC instruments and not to third-party plugins.

**Global Pitch Bend:** Check this box to override the pitch bend settings of all programs, so that those with pitch bend disabled or set to different ranges will only use the Global Range instead. When unchecked, all programs may use their individual pitch bend settings.

## Mod Wheel

Select this mode to use the touch strip as you would a mod wheel on a typical keyboard to control the MIDI CC1 modulation control.



## Sustain

Select this mode to use the touch strip as you would a sustain pedal on a typical keyboard to enable or disable note sustain. When enabled, notes will continue sounding until sustain is disabled.

## Expression

Select this mode to use the touch strip as you would an external expression pedal to control the MIDI CC11 expression control.

## Q-Link

Select this mode to use the touch strip as a Q-Link control as found on other MPC hardware.

**To configure the Q-Link settings**, press and hold **Shift** and press the **Touch Strip** button to open the Touch Strip Q-Link window in the software.

**Q-Link:** Use this field to select which Q-Link is controlled by the touch strip (1–16). You can also press one of the 16 pads to select that Q-Link while the Touch Strip Q-Link window is open in the software.

## Pad Level

Select this mode to use the touch strip to control the current Pad Level.

## Program Level

Select this mode to use the touch strip to control the current Program Level.

## Project

Select this mode to assign a project parameter to the touch strip control.

**To configure the Project settings**, press and hold **Shift** and press the **Touch Strip** button to open the Touch Strip Project Mode Config window in the software.

**Source:** Use this field to select the location of the project parameter: MIDI Track, Audio Track, Program (and Pad), Return, Submix or Main (Output).

**Parameter:** Use this field to select a project parameter to control with the touch strip. The available parameters depend on the type of **Source** selected.

When the **MIDI Track** source is selected:

**Off**

**Mixer:** Volume, Pan, Mute, Solo

When the **Audio Track** source is selected:

**Off**

**Mixer:** Volume, Pan, Mute, Solo, Send 1–4

**Insert 1–4:** Other available parameters depending on the effect

When the **Program** source is selected, and a **Program** is selected:

**Off**

**Mixer:** Volume, Pan, Mute, Solo, Send 1–4

**Program:** Global Semi Tune, Global Fine Tune

**Insert 1–4:** Other available parameters depending on the effect

When the **Program** source is selected, and a **Pad** is selected:

**Off**

**Mixer:** Level, Pan, Pad Mute, Pad Solo, Send 1–4

**Program:**

|                         |                          |                        |                               |
|-------------------------|--------------------------|------------------------|-------------------------------|
| Tuning                  | Filter Env Decay Curve   | Layer Fine Tune (1–4)  | Layer Offset (1–4)            |
| Filter Cutoff           | Filter Env Release Curve | Velocity to Start      | Layer Loop Xfade (1–4)        |
| Filter Resonance        | Pitch Env Attack         | Vel to Filter Attack   | Layer Loop Xfade Type (1–4)   |
| Filter Env Amount       | Pitch Env Hold           | Velocity to Env Amount | Layer Slice Tail Length (1–4) |
| Amp Env Attack          | Pitch Env Decay          | Velocity to Filter     | Layer Slice Tail Start (1–4)  |
| Amp Env Decay           | Pitch Env Sustain        | LFO to Pitch           | Layer Pitch Random (1–4)      |
| Amp Env Release         | Pitch Env Release        | LFO to Filter          | Layer Level Random (1–4)      |
| Amp Env Hold            | Pitch Env Decay Mode     | LFO to Amp             | Layer Pan Random (1–4)        |
| Amp Env Sustain         | Pitch Env Attack Curve   | LFO to Pan             | Layer Offset Random (1–4)     |
| Filter Env Attack       | Pitch Env Decay Curve    | LFO Wave               | Attack Random                 |
| Filter Env Hold         | Pitch Env Release Curve  | LFO Rate               | Decay Random                  |
| Filter Env Decay        | Pitch Env Depth          | LFO Sync               | Cutoff Random                 |
| Filter Env Sustain      | Pitch Env Type           | Velocity to Pitch      | Resonance Random              |
| Filter Env Release      | DrumFX (1–8)             | Vel to Volume Attack   | Total Random Amount           |
| Amp Env Attack Curve    | DrumFX Type (1–8)        | Velocity to Amp        | LFO Level                     |
| Amp Env Decay Curve     | Layer Level (1–4)        | Velocity to Pan        | LFO Delay                     |
| Amp Env Release Curve   | Layer Sample Pan (1–4)   | Layer Slice (1–4)      | LFO Fade In                   |
| Filter Env Attack Curve | Layer Semi Tune (1–4)    | Layer Reverse (1–4)    |                               |

**Insert 1–4:** Other available parameters depending on the effect

When the **Return** source is selected:

**Off**

**Mixer:** Volume, Pan, Mute

**Insert 1–4:** Other available parameters depending on the effect

When the **Submix** source is selected:

**Off**

**Mixer:** Volume, Pan, Mute, Send 1–4

**Insert 1–4:** Other available parameters depending on the effect

When the **Main** source is selected:

**Off**

**Mixer:** Volume, Pan, Mute

**Insert 1–4:** Other available parameters depending on the effect

**Momentary:** Check this box to turn momentary behavior on or off.

When **on**, moving your finger along the touch strip will adjust its parameter, but the parameter will immediately return to its original position (when you turned Momentary on) when you release your finger from the touch strip.

When **off**, moving your finger along the touch strip will adjust its parameter, and the parameter will remain at its new setting when you release your finger from the touch strip.

## Note Repeat

You can also use the touch strip for Note Repeat control.

**To enable Note Repeat**, press and hold the **Note Repeat** button. You can then use the touch strip to control the rate of Note Repeat, as indicated by the LEDs next to the touch strip.

**To latch Note Repeat**, press and hold **Shift** and press the **Note Repeat** button. When latched, you do not have to keep your finger on the touch strip for Note Repeat to be activated.

## Updates in MPC 2.11

### New Features

#### MPC Key 61 Support

MPC 2.11 adds support for the Akai Professional MPC Key 61 hardware. For a breakdown of MPC Key 61's controls, see [Features > MPC Key 61](#).

MPC Key 61 also includes a new Keyboard Control menu for customizing how its 61-key keyboard is used.

**To access Keyboard Control**, press the **Keyboard Control** button on your MPC Key 61. You can then edit the following parameters.

#### Keyboard Input

**Transpose:** This determines the amount of transposition to the keyboard, up to **36 semitones** up or down.

**MIDI Channel:** This determines which MIDI channel (**1–16**) the keyboard input will use to receive messages.

**Aftertouch (Channel Pressure):** This determines whether aftertouch is enabled (**As Played**) or not (**Disable**).

**Note On Velocity:** This determines the incoming velocity of note on messages. For velocity that is responsive to your playing, select **As played**. Alternatively, you can set a fixed velocity for all note on messages, at **12%, 18%, 25%, 31%, 37%, 43%, Half, 56%, 62%, 68%, 75%, 81%, 87%, 93%** or **Full** velocity.

#### Scale Filter

**Filter Input:** This determines how specific notes are filtered. Select **As Played** to apply no filtering, **Snap to Scale** to shift non-scale notes played to the nearest scale degree, or **Filter to Scale** to disable non-scale notes from playing entirely.

**Root Note:** This determines the root note of the set scale.

**Scale:** This determines the type of scale used for note filtering. The available scales are:

|                  |                  |          |                 |
|------------------|------------------|----------|-----------------|
| Chromatic        | Pentatonic Minor | Aeolian  | Hungarian Gypsy |
| Major            | Dorian           | Locrian  | Persian         |
| Natural Minor    | Phrygian         | Blues    | Major Bebop     |
| Harmonic Minor   | Lydian           | Flamenco | Whole Tone      |
| Pentatonic Major | Mixolydian       | Gypsy    |                 |

#### Internal Keyboard Routing

**Keyboard Route:** This determines where MIDI data from the keyboard is sent. Select from the following options:

**Local Off:** Keyboard MIDI data is only sent to the MIDI out. This may be useful if working with external sound modules.

**Global:** Keyboard MIDI data will always go to the current track.

**Tracks:** The Keyboard will appear as a port in the list of available track MIDI Inputs.

**Global and Tracks:** Keyboard MIDI data will go to the current track and be available as a track MIDI input.

## External Keyboard Routing

**MIDI Output Port:** This determines the MIDI port where the keyboard will output MIDI externally.

**Keyboard sends MIDI here:** Check this box to send all MIDI from the keyboard to the selected MIDI Output port.

**MIDI Channel:** This determines which MIDI channel (**1–16**) the keyboard will use to send messages externally.

**Minimum Note / Maximum Note:** This determines the range of notes that will output MIDI externally.

## Keyboard Settings

**Velocity Response:** This determines how playing the keys translates into velocity values. Select preset **Light 1–3**, **Linear**, or **Heavy 1–3** responses, or select **Custom** to create your own response using the following settings:

**Velocity Curve:** Use this slider to adjust the velocity curve, from **-50** to **0** to **+50**. At negative values, it takes more force to hit higher velocity values; at positive values, it takes less force.

**Gain:** Use this slider to apply additional gain to the velocity curve, from **-20** to **0** to **+20**. Increasing the gain will make it easier to hit high velocity values, and decreasing it will make it harder.

**Black Key Sensitivity:** Use this slider to set the sensitivity of the keyboard's black keys, from **-20** to **0** to **+20**.

**White Key Sensitivity:** Use this slider to set the sensitivity of the keyboard's white keys, from **-20** to **0** to **+20**.

## Pedal Settings

**Pedal:** This determines the pedal input port from MPC Key 61. Select **Sustain**, **FS2**, or **Expression**.

**Type:** This determines the pedal type, either **Switch** (on/off) or **Variable** (such as an expression pedal).

**Polarity:** This determines the polarity of the pedal input. Select **Auto**, **Positive**, or **Negative**. If you are having issues with your pedal, check the settings on your hardware or try adjusting this field for the correct behavior.

**CC Assign:** This is the MIDI CC assignment the pedal will send. Select **Disable**, **Default** (varies depending on the port used), or **CC 000–126**.

## Pitch Bend / Mod Wheel

**Pitch Bend:** Use this field to select the MIDI function for the keyboard pitch wheel. Select **Disable**, **Default – Pitch Bend**, or **CC 000–126**.

**Mod Wheel:** Use this field to select the MIDI function for the keyboard modulation wheel. Select **Disable**, **Default – CC 001: Modulation**, or **CC 000–126**.

## Global Pitch Bend Settings

**Global Pitch Bend:** Check this box to override the pitch bend settings of all programs, so that those with pitch bend disabled or set to different ranges will only use the Global Range instead. When unchecked, all programs may use their individual pitch bend settings.

**Range Up/Range Down:** Use these sliders to set the range of the pitch bend in semitones.

MPC Key 61 also includes touch strip and touch FX support.

### To use the touch strip with MPC Key 61:

1. Press the **Touch Strip** button to enter Touch Strip mode selection.
2. Press the **Touch Strip** button again repeatedly to cycle through the available Touch Strip modes as shown on MPC Key 61's display:
  - Notes
  - Pitch Bend
  - Mod Wheel
  - Sustain
  - Expression
  - Q-Link
  - Pad level
  - Program Level
  - Project

You can also press and hold the Touch Strip button and use the window that appears to select a mode.

3. Press your finger on the **touch strip** and move it up and down as an expressive control for the selected parameter.
4. Press and hold **Shift** and press the **Touch Strip** button to configure settings for each mode, if available.

### To load the Touch FX plugin from MPC Key 61:

1. Tap an empty slot in the **Inserts** section of any channel strip.
2. Double-tap an empty insert slot in the Effects window to open the list of plugin effects
3. Tap the + or – button to expand the **Harmonic** category.
4. Select the **TouchFX** plugin.
5. Tap the **pencil icon** to open the plugin window, where you can adjust the plugin settings.

**Note:** In standalone mode, starting an empty project will automatically place an instance of Touch FX on **Outputs 1/2**.

Alternatively, you can insert Touch FX into the channel strip from the **Touch FX** setup window (**Shift+Touch FX**).

### To use Touch FX with MPC Key 61:

1. If it is not already, press the **Touch FX** button to set the touch strip to Touch FX mode. Touch FX mode is the default mode for the MPC Key 61 touch strip.
2. Press and hold **Shift** and press the **Touch FX** button to open the Touch FX setup window.  
Press the **Touch FX Setup** button at the bottom of the touchscreen to open the effect window.
3. Once setup is complete, you can also press and hold the **Touch FX** button to quickly select one of the available effects linked above.

See [Addenda > Updates in MPC 2.10.1 > New Features > Touch Strip and Touch FX](#) for more information on the touch strip and touch FX modes.

## Sounds and Favorites

MPC now includes two new menus for browsing included plugin instruments, the Sounds and Favorites menus.

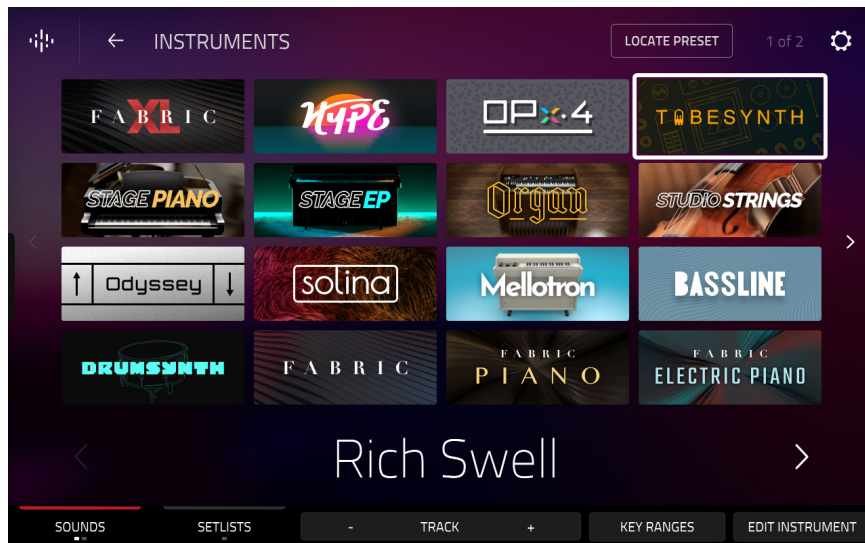

To enter the **Sounds** and **Favorites** menus, do any of the following:

- In **Main** mode, select a **plugin track** and then tap the **Sounds** or **Favorites** buttons in the Program section.
- Press **Menu**, and then tap **Sounds**.
- Press **Sounds** (MPC Key 61).

When viewing either the Sounds or Favorites menu, you can swap to the other menu by tapping the first tab at the bottom of the touchscreen.

Tap the **gear icon** at the top of the screen to open the Sounds menu settings. Here, you can set the default Sounds menu view to be **Instruments** or the **Current Preset**.

Tap **Locate Preset** at the top of the touchscreen to open the preset list for the currently selected plugin instrument.

Tap **Track -/+** to move to the previous or next track.

Tap the **← Instruments** button to select another program type to search for using the Sounds interface. You can search for **Drum**, **Plugin**, **Keygroup**, **Clip**, **MIDI**, and **CV** program types in any factory expansions or user expansions on any attached drives. When browsing an expansion or user folder, tap a cell to load the selected program.

When searching for non-Plugin programs, you can also tap and hold on an empty space to set a preferred folder location for your saved programs.

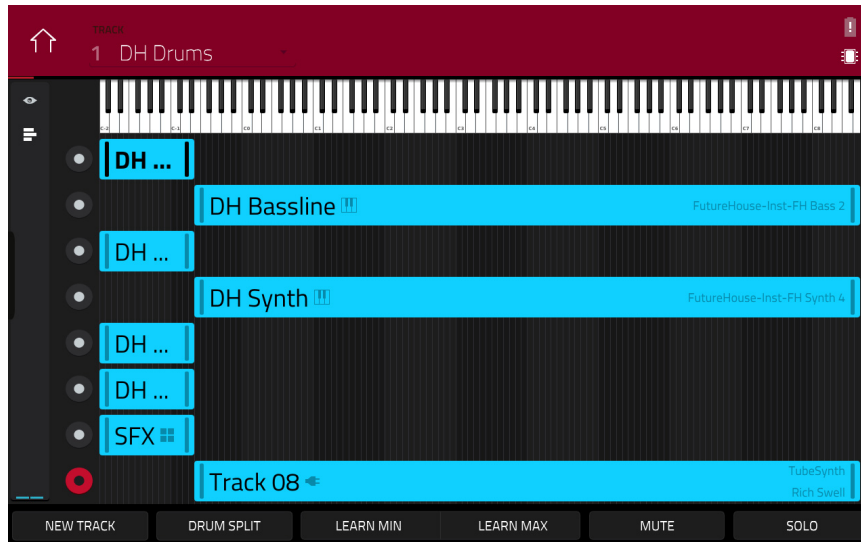

Tap **Key Ranges** to set the MIDI key ranges for each track. This can allow you to play multiple instruments from one keyboard.

**To add a new track**, tap **New Track**, and then select the type of track to add.

**To instantly adjust the key range for drum tracks**, tap **Drum Split**. This will automatically set the key range to the first 16 notes of the keyboard to correspond with Pads 1–16. This is useful for using the MPC Key 61 to play melodic sounds on the keyboard and drum sounds on the pads at the same time.

**To adjust the key range**, tap and drag from the ends of the blue bar for each track. Alternatively, tap **Learn Min** or **Learn Max** and then press a key on a connected keyboard to set that note as the min or max.

**To mute the current track**, tap **Mute**.

**To solo the current track**, tap **Solo**.

**To view the channel strip for the current track**, tap the **eye icon** on the left side of the touchscreen. See [Operation > Modes > Main Mode](#) for more information on using the channel strip.

Tap **Edit Instrument** at the bottom of the touchscreen to open Program Edit Mode to adjust the instrument parameters.

#### To save a preset as a favorite:

1. Select the desired plugin and preset using the Sounds menu.
2. Open the Favorites menu by tapping the bottom-left tab in the Sounds menu, or by tapping **Favorites** in the Plugin Program section of Main mode.
3. Press and hold on an empty Favorites slot to save the preset in the selected slot.

**To edit an existing Favorite slot**, tap and hold on a filled Favorite slot. In the menu that appears:

- Tap **Clear** to clear the slot.
- Tap **Overwrite** to replace the favorite with the currently selected preset.

#### Performances

The Performances tab is available for MPC Key 61 users with an MPC Keys Performance expansion installed. Tap one of the slots to load a sample Performance project, which show off the layering and key split capabilities of MPC Key 61. Each performance project loads with a drum kit and multiple instruments mapped across the key range for fast experimentation.



## Setlists

Use the Setlists tab to create a list of projects to easily recall, such as for a live performance.

### To create a Setlist:

1. Open the Setlist tab from the Sounds page.
2. Tap and hold on an empty Setlist slot, and then tap **Choose Project**.
3. In the file browser that appears, locate the project you would like to add and then tap **Select** to load it.

**To edit an existing Setlist slot**, tap and hold on a filled slot. In the menu that appears:

- Tap **Choose Project** to select a different project for the same slot.
- Tap **Clear** to empty the selected slot.
- Tap **Copy** to copy the project to another slot. Then, tap and hold on an empty slot and tap **Paste**.

## New Plugin Instruments

You can now purchase a range of new plugin instruments for use with MPC standalone, MPC desktop software, and other DAWs.

**AIR OPX-4** is the brand-new four operator FM powerhouse, delivering the ultimate in FM synthesis sound shaping. The instrument includes:

- Advance FM Synthesis: Four Operators, each capable of producing complex waveforms through feedback, formant shaping, FM filtering and FM shaping parameters.
- Dual-mode filter path with 23 different filter types.
- Six envelopes with tempo-synchronized looping.
- Two LFOs and two Ramps.
- Three insert effect slots and two global effect slots, with a huge library of 27 AIR effects including reverbs, delays, modulations, and distortions.
- Modulation Matrix with 32 slots.
- Sample layer for adding percussive attacks.
- Over 670 factory presets included.

**AIR Stage Piano** is the brand-new flagship acoustic piano instrument. With an elegant interface, you can tweak the sound of each piano model to your taste by changing the dynamics, age, and formants of the piano timbre and adjust note release samples and sustain resonance to increase realism. From the depth and richness of a concert grand to the upright jazz feel of the most vibrant club, Stage Piano and its inspiration selection of carefully crafted presets are perfect for capturing the moment. The instrument includes:

- Advanced acoustic piano sound engine
- Up to six velocity layers.
- Four multi-sampled acoustic pianos: Yamaha C7, Steinway D, Bechstein Upright, and Workstation.
- Sympathetic resonance.
- Hammer fall and staccato release layers.
- Equal and stretched tunings.
- Five built-in AIR effects: Flavor, Compressor, EQ, Delay, and Reverb.

**AIR Stage EP** is the brand-new flagship electric piano instrument, delivering the lush and rich sounds of the most desirable electric pianos at your fingertips. Stage EP includes five detailed electric piano models, including acoustic mechanics and an FM tine synth, to capturing the magic and warm smoothness of the originals, while also adding the full spectrum of modern and classic electronic sounds.

This instrument includes:

- Advanced electric piano sound engine.
- Up to twelve velocity layers.
- Five multi-sampled electric pianos: Rhodes, Rhodes Hot, Suitcase, Wurlitzer, Pianet.
- Acoustic and FM mechanics layer.
- Seven built-in AIR effects: Chorus, Tremolo, Amp Sim, Compressor, EQ, Delay, and Reverb.

**AIR Studio Strings** is the brand-new orchestral strings instrument, bringing the rich and elegant sounds of orchestral, chamber, and solo strings inside your MPC. Create beautifully articulated masterpieces from a powerful sampled library featuring combined and individual strings, including Violin, Cello, Bass, and Viola.

This instrument includes:

- Advanced four-part, sample-based string ensemble engine.
- Orchestral, chamber, and solo sample sets.
- Unique intelligent legato engine.
- Four built-in AIR effects: Flavor, EQ, Delay, and Reverb.

**AIR Organ** is the brand-new organ instrument for MPC, delivering advanced drawbar organ additive synthesis for every musical occasion. With ten incredible tonewheel sets, all gathered from authentic vintage organs, and the award-winning rotary speaker simulation from AIR DB33, AIR Organ will bring you a rich, expressive experience in a stunning user interface.

This instrument includes:

- Advanced drawbar organ additive synthesis engine.
- 10 different drawbar models sampled from vintage organs.
- Percussion layer and key click sounds.
- Scanner vibrato.
- Four built-in AIR effects: Rotary, EQ, Delay, and Reverb.

The Fabric Series includes four new plugin instruments: Fabric XL, Fabric, Fabric Piano, and Fabric Electric Piano.

**Fabric XL** is the brand-new flagship sample-based synthesizer from AIR Music Technology and delivers the ultimate sounds for all your production needs. Fabric XL brings a stunning collection of cutting-edge presets, including everything from twisted and dark motion pads, drone and sub-basses, acoustic and electric guitars, acoustic and electric pianos, classic poly and lead synths, and much more.

**Fabric** is almost identical to Fabric XL, but removes the largest sample keymaps to reserve less of your MPC's memory.

**Fabric Piano** and **Fabric Electric Piano** deliver the sonic characteristics of the flagship Stage Piano and Stage EP instruments, respectively, but in less CPU-intensive forms. Each includes a comprehensive set of editing features and built-in effects, such as the AIR Flavor effect for adding grit for a lo-fi sound.

## Activating Instrument Plugins

If you have purchased an MPC instrument, you can activate it on up to three devices.

**Note:** Activation requires an internet connection.

### To activate plugins:

4. Open the **Preferences** menu by pressing **Menu** or tapping the icon in the upper-left corner of the screen, and then tapping the **Preferences** icon at the bottom of the screen.
5. You will need a valid internet connection to activate your plugins, so if you are not already connected, use the **Wi-Fi** or **Ethernet** menus to select your network.
6. Tap the **Activate Plugins** option on the left side of the screen.
7. Tap the **Log In** button to log into your inMusic Profile. You can scan the QR code with a mobile device or open the URL shown on the page in a browser of your choice. If you do not already have an account, you will be prompted to create one.
8. Once you have been logged in, you can try out plugin instruments through a free trial, or activate your purchases.

**To start a trial**, tap the **Start Trial** button next to the desired plugin.

**To register a purchase**, use the **Enter Serial** field to enter your serial number and then tap **Register**.

**To refresh the page with your latest purchases or activations**, tap **Refresh**.

**To activate a plugin on your device**, tap the **Activate** button next to its name. Tap **Deactivate** to remove the plugin activation from your device.

**To download a purchase to your device**, first tap the **Change** button at the bottom of the touchscreen to select a Content Download Drive. This can be a connected SATA drive, USB drive, or SD card. Then, tap the **download icon** to begin downloading the plugin to your drive. The download icon will change to show the installation progress. Once the process is complete, you can use your plugin with standalone MPC.

**To log out of your account**, tap **Log Out**.

## Insert Effect Updates

MPC now includes two new AIR insert effects: AIR Amp Simulation and AIR Flavor.

### AIR Amp Sim

This effect simulates guitar and bass amplifiers with a wide range of available cabinet models and tone shaping options.

| Parameter | Value Range  | Default Value |
|-----------|--|---------------|
| Cab Model | D.I., Brit, 1x8", 1x12", 2x10", 2x12", 4x10", 4x12", 1x15" Bass, 4x10" Bass, Radio | 4x10"         |
| Drive     | 0.0–11.0   | 0.0           |
| Mode      | Mono, Stereo   | Stereo        |
| Output    | -12.0 – 0.0 – +12.0 dB   | 0.0 dB        |
| Soft Clip | 0–100%   | 0%            |
| Top Boost | 0–100%   | 0%            |
| Bias      | 0–100%   | 0%            |
| Bass      | -12.0 – 0.0 – +12.0 dB   | -12.0 dB      |
| Mid       | -12.0 – 0.0 – +12.0 dB   | 0.0 dB        |
| Mid Freq  | 250 Hz – 4.00 kHz  | 1.00 kHz      |
| Treble    | -12.0 – 0.0 – +12.0 dB   | 0.0 dB        |

## AIR Flavor

This effect applies EQ simulations of radios, phones, tape machines, and more to dramatically change the timbre of your sound.

| Parameter        | Value Range | Default Value |
|------------------|-------------|---------------|
| Timbre           | Varies      | Neutral       |
| Timbre Depth     | 0–100%      | 100%          |
| Vinyl Distortion | 0–100%      | 0%            |
| Vinyl Noise      | 0–100%      | 0%            |
| Flutter          | 0–100%      | 0%            |
| Monofy           | 0–100%      | 0%            |

Additionally, the following improvements have been made to existing MPC plugins:

- Rack FX presets have been updated to include presets that use the **AIR Flavor** and **AIR Amp Sim** effects.
- The Akai **Granulator** effect now includes three new parameters for more control over the grains: Reverse, Shape, and Skew.
- The **AIR Vocal Tuner** effect now includes a suite of factory presets.
- The **AIR Reverb** effect now has an expanded range of factory presets.

## Menu Editing and Shortcuts Panel

You can now edit the order of MPC modes in the **Menu**.

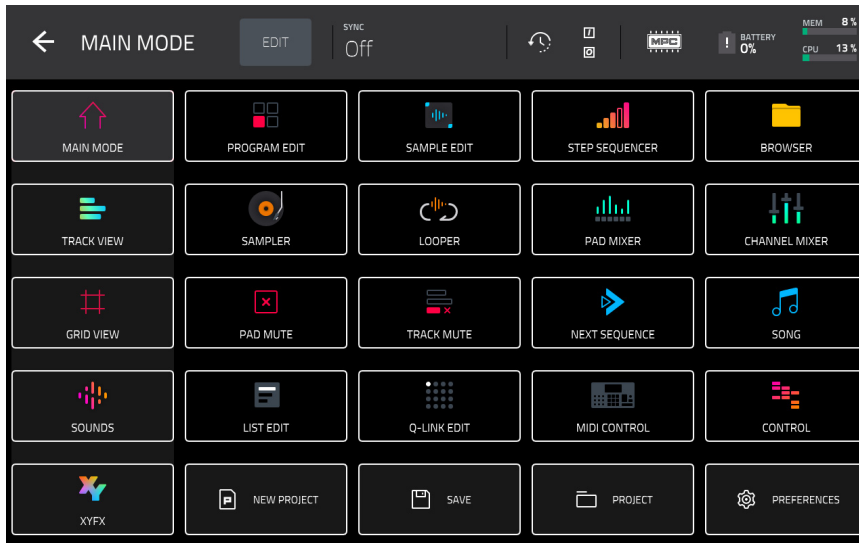

### To edit the Menu appearance:

1. Press **Menu**, or tap the icon in the upper-left corner of the screen while viewing any mode.
2. Tap the **Edit** button at the top of the touchscreen, or press and hold **Shift**. The menu icons will now be outlined to indicate editing is enabled.
3. Tap and drag the menu icons to your preferred location.  
Mode icons placed in the left-most column will be available in the shortcuts panel in other modes.  
The bottom row also serves as a shortcut area that by default lets you quickly create a new project, save projects or other MPC files, open the Project popup, and access Preferences.  
The remaining sixteen modes in the main area of the Menu will also be available to select by pressing and holding **Menu** and tapping a pad according to your selected layout.
4. To exit editing and commit your changes, tap the **Edit** button again, or release the **Shift** button.

**To return the menu to the default order**, press and hold **Shift** and then tap **Reset** at the top of the touchscreen.

**To use the shortcuts panel**, swipe the black touch handle to the right from the left edge of the touchscreen while viewing any mode. The five modes from the left-most column of the Menu can be accessed here.

**To close the shortcuts panel**, swipe the menu to the left, or select one of the modes.

## Built-In Tuner

Standalone MPCs now include a built-in tuner function, allowing you to easily tune any connected audio sources such as guitars, basses, synth modules, and other pitched instruments.

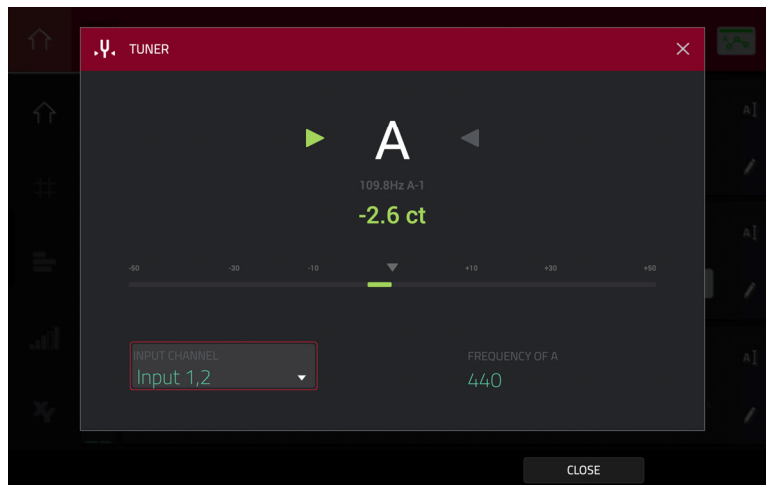

### To access the tuner:

1. Open the Menu by pressing **Menu**, or tapping the icon in the upper-left corner of the screen while on the normal page of your current mode.
2. Tap the **tuning fork** icon at the top of the touchscreen.
3. In the window that appears:
  - Use the **Input Channel** field to select the input for the instrument you would like to tune.
  - Use the **Frequency of A** field to set the base tuning frequency.
4. Play a note and use the indicator to adjust your instrument to the correct pitch.
5. To close the tuner screen, tap **Close**, the **X** in the upper-right corner, or anywhere outside the window.

You can also access the tuner from the **Sampler** mode by tapping the **tuning fork** icon at the top of the touchscreen.

## Note Probability and Note Ratchet

You can now add probability and create roll effects by adding ratchets to any note in the MPC sequencer. You can apply probability and ratchet from your MPC in Grid View or by using 16 Levels.

### To apply probability or ratchet to a note in Grid View:

1. Open **Grid View**.
2. Tap the up **arrow** ( $\wedge$ ) button in the lower-right corner to show the velocity/automation lane.
3. Tap to select the current parameter (by default, Velocity), and then use the **data dial** or **-/+** buttons to select **Probability** or **Ratchet**.
4. Adjust the blue bars to alter the probability that the note will play, or the ratchet subdivisions for the selected notes. The subdivisions are shown as dotted lines on the original note.

You can also view and adjust the probability or ratchet information using the Step Sequencer. Select the desired note and then set the Step Sequencer **Parameter** to **Probability** or **Ratchet**. As the bars are adjusted, the current probability value (**1–100%**) or ratchet subdivision (**Off, 2-8**) will be shown in the **Parameter** field. The ratchet value will also be shown in the note on button beneath the accompanying slider.

### To apply probability or ratchet using 16 Levels:

1. Press the pad with the note where you would like to add probability or ratchet.
2. Press the **16 Levels** button to open the 16 Levels window.
3. In the 16 Levels window, set the **Type** field to **Probability** or **Ratchet**.
4. The 16 pads will now represent probability that the note will play from lowest to highest, or increasing ratchet subdivision values.

Note probability and ratchet values will also be saved and loaded as part of MPC pattern files (.mpcpattern).

### Pad Perform and 16 Levels Enhancements

You can now use 16 Levels with all Pad Perform settings. Instead of producing an error message when 16 Levels is activated on a melodic program, 16 Levels will activate as follows:

- For Pad Perform modes where a pad plays a single note (Chromatic, Notes, Custom), activating 16 Levels will apply to the current note.
- For Pad Perform modes where there is more than one note per pad (Chords, Chromatic Chords, Progressions), activating 16 levels will apply to the root note of the current chord.
- For melodic programs that are not keygroups, only Velocity, Probability, and Ratchet options are available for 16 Levels.

Five extra chord progressions have also been added to **Pad Perform > Progressions**.

Pad Perform mode also now supports user-created pad note maps by selecting the **Custom** type. After this option is selected in the Pad Perform mode window:

1. Tap the **Edit Note Map** button to begin editing.
2. Tap a pad or use the **Pad** field to select a pad.
3. Use the **MIDI Note** field to set the desired note.
4. When you are finished editing, tap **Close**, the **X**, or anywhere outside the window.

You can also choose from three presets: **Chromatic C1**, **Chromatic C2**, or **Classic MPC**.

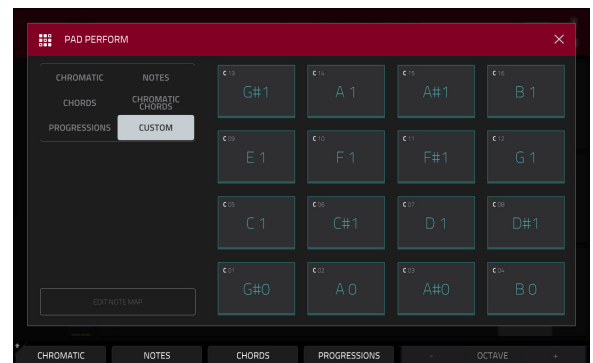

## Track MIDI Perform Settings

The MPC Track View has been redesigned and you can now edit a MIDI track's MIDI perform settings, making it easier to control multiple tracks at the same time on the same controller.

### To open the Track MIDI Perform Settings window:

1. Open Track View by pressing **Menu**, and then tapping **Track View**.
2. Tap the **Filter** button under **Solo** for the desired MIDI track.
3. In the window that appears, you can adjust the following settings:
  - **Note Range:** This determines the **Note Min** and **Note Max** range that passes MIDI. Notes outside this range will not be heard in the track. You can also adjust this directly from Track View by using the **Keyrange** fields. Tap **Learn** and press the desired note for the Min and Max values.
  - **Velocity Range:** This determines the **Velocity Min** and **Velocity Max** that passes MIDI. Velocities outside this range will not be heard in the track.
  - **MIDI CC Filter:** Check these boxes to allow the listed MIDI Control Change messages to pass through the track. When unchecked, the MIDI CC message type will be ignored by the track. You can filter the following MIDI CC messages:

|                     |                                   |
|---------------------|-----------------------------------|
| CC1 Modulation      | CC65 Pmento (Portamento) On/Off   |
| CC2 Breath          | CC66 Sost (Sostenuto) On/Off      |
| CC3 Undefined       | CC67 Soft Ped (Soft Pedal) On/Off |
| CC4 Foot            | CC68 Legato Switch                |
| CC5 Portamento      | CC128 Pitchbend                   |
| CC7 Volume          | CC130 Program Change              |
| CC10 Pan            | CC129 Channel Pressure            |
| CC11 Expression     | CC131 Aftertouch                  |
| CC64 Sustain On/Off |                                   |

## MIDI Control Mode Updates

MIDI Control Mode now has two additional toolbar items:

- Use the **MIDI Output Port** field to set where outgoing MIDI is sent without having to leave the MIDI Control Mode page. This is the same setting as found in **Preferences > MIDI/Sync > Output Ports > MIDI Control Mode**.
- Tap the **I/O** icon to open the **MIDI Monitor**, where you can view incoming and outgoing MIDI messages.

## Workflow Improvements and Enhancements

The AIR DrumSynth-Multi plugin instrument effect now has assignable mute groups. The accompanying factory presets have been updated to use them.

MPC now supports Ableton Link v3. Go to **Preferences > MIDI / Sync > Sync Receive** and enable the **Ableton Start/Stop Sync** parameter to sync the MPC transport with other Ableton Link devices.

A new setting has been added to **Preferences > Hardware > General** to set the **Shift + Q-Link** button behavior to either open the Q-Link Edit window or Cycle Backwards.

References to Master have been renamed Global or Main.



The Drum Program note map is now Chromatic starting from C1 by default.

The Project popup now has an Audition function key.

Arpeggiator settings and XYFX location are now saved and recalled with your MPC project.

In Program Edit mode, you can now tap the **keyboard-plus** icon at the top of the screen to quickly convert a drum sample to a new keygroup program.

The **Slice** assigned to a drum pad layer can now be automated.

Plugin instruments will now show a loading progress bar on the touchscreen for presets.

Changing an “unused” track’s program no longer makes it used.

When selecting the **User Template** option on the Demo screen, a popup now indicates where to set a template in the Preferences menu if one has not already been set.

## Updates in MPC 2.11.6

### New Features

#### AIR Flavor Pro and Mini D

MPC now supports the AIR Flavor Pro and AIR Mini D plugins, which are available for purchase at [thempcstore.com](http://thempcstore.com).

**AIR Flavor Pro** is the brand-new flagship lo-fi multi-effects plugin, designed to manipulate samples, melodies, loops, and instruments to the extreme for today's modern lo-fi sound. Flavor Pro transforms the MPC standalone effects experience to a whole new future/retro landscape.

At the heart of Flavor Pro's ingredients are six powerful effects modules providing immersive lo-fi control with unlimited possibilities. Add instant-color effects ranging from pitch flutter, tape saturation, tape dropouts, distortion, and drift, to 12/8-bit sampling, vinyl rumble, hum, pops, and crackle emulations. Whatever your musical style, Flavor Pro's powerful multi-effects layout allows instant vintage magic and manipulation of your production in a fast and creative way.

**AIR Mini D** is a faithful reproduction of the classic analogue mono-synth. Effortlessly create thunderous bass or searing leads using this tried and tested classic subtractive synth layout. Use the extended four-voice polyphony and effects to play pads, plucks, and keys patches like you never could on the original.

- 8 oscillator waveforms.
- Choose between two different filter models, a classic ladder filter emulation or AIR's own modern filter for a different sonic flavor with feedback and modelled distortion.
- Multiple LFO shapes with 19 selections including ramps, sine, square, triangle, random, and steps.
- Legato, Retrigger, Unison and the option to use Mini D as up to a four-voice polyphonic synthesizer for luscious pads and plucks.
- Last, First, High and Low Note Priority options.
- Built-in AIR effects including AIR Chorus, AIR EQ and AIR Delay.
- Appears in MPC Sounds mode and includes over four hundred inspiring patches.

#### Workflow Improvements

On the Activate Plugins page of the Preferences menu, uninstalled plugins will show an instrument or effect icon to indicate the plugin type.

## Updates in MPC 2.11.7

### New Features

#### VST Preset Loading

You can now load presets saved in VST versions of MPC plugins into the internal versions for MPC standalone.

#### To load a preset:

1. Open the plugin instrument or insert effect.
2. Tap the **folder icon** at the top of the screen.
3. Use the file browser to locate and load the saved preset.

## Updates in MPC 2.11.9

### New Features

#### MPC X Special Edition Support

MPC 2.11.9 adds support for the Akai Professional MPC X Special Edition hardware.

**Note:** Mentions of the features and functions of MPC X hardware throughout this guide also apply to the MPC X Special Edition unless otherwise noted.

## Updates in MPC 2.12

### New Features

#### MPC One+ Support

MPC 2.12 adds support for the Akai Professional MPC One+ hardware.

**Note:** Mentions of the features and functions of MPC One hardware throughout this guide also apply to the MPC One+ unless otherwise noted.

## Updates in MPC 2.12.2

### New Features

#### New Plugin Effects and Improvements

Your standalone MPC now supports four new AIR plugin insert effects, which are available for purchase at [thempcstore.com](http://thempcstore.com):

##### AIR Chorus

This effect is a compact but powerful plugin for classic chorus warmth and depth.



| Parameter | Value Range          | Default Value |
|-----------|----------------------|---------------|
| Rate      | 0.01 – 10.0 Hz       | 1.01 Hz       |
| Depth     | 0.00 – 24.00 ms      | 7.10 ms       |
| Mix       | 0–100%               | 50%           |
| Feedback  | 0–100%               | 0%            |
| Pre-Delay | 0.00–24.00 ms        | 2.00 ms       |
| Wave      | Triangle, Sine       | Sine          |
| Offset    | -180 – 0 – +180 deg. | +90 deg.      |

##### AIR Expander

This effect is a vital dynamic processor to reduce and remove the unwanted quieter elements of your tracks.



| Parameter | Value Range            | Default Value |
|-----------|------------------------|---------------|
| Threshold | -40.0 – 0.0 dB         | -15.4 dB      |
| Output    | -20.0 – 0.0 – +20.0 dB | 0.0 dB        |
| Ratio     | 1:1.0 – 1:100          | 1:10          |
| Range     | 0.0 – 40.0 dB          | 40.0 dB       |
| Attack    | 10.0 us – 100 ms       | 1.00 ms       |
| Release   | 10.0 ms – 10.0 s       | 166 ms        |

### AIR Multitap Delay

This effect is a versatile, creative delay plugin with a wide range of applications from subtle stereo delays to complex repeating patterns.



| Parameter | Value Range         | Default Value |
|-----------|---------------------|---------------|
| Delay     |                     |               |
| Sync On:  | 1/16 – 8/4          | 4/4           |
| Sync Off: | 0 ms – 4.00 s       | 2.25 s        |
| Feedback  | 0–100%              | 50%           |
| Mix       | -100.0 – 0.0 dB     | -50.0 dB      |
| From/To   | Varies              | Tap 5 / Input |
| Sync      | Off, On             | On            |
| Low Cut   | 20.0 Hz – 1.00 kHz  | 500 Hz        |
| High Cut  | 1.00 kHz – 20.0 kHz | 2.00 kHz      |
| 1–5       | Off, On             | On            |
| Tap Delay | 10.0 ms – 10.0 s    | Varies        |
| Pan       | L100 – C – R100     | Varies        |
| Level     | -Inf – 0.0 dB       | 0.0 dB        |

### AIR Vintage Filter

This effect is a powerful filter plugin for bringing those classic analog filter sounds to your tracks, perfect for synths, guitars plus loads more.



| Parameter  | Value Range              | Default Value |
|------------|--------------------------|---------------|
| Cutoff     | 20.0 Hz – 20.0 kHz       | 878 Hz        |
| Resonance  | 0–100%                   | 0%            |
| Fat        | 0–200%                   | 200%          |
| Mode       | LP24, LP18, LP12, BP, HP | LP18          |
| Attack     | 10.0 ms – 10 s           | 10.0 ms       |
| Release    | 10.0 ms – 10 s           | 966 ms        |
| Env. Depth | -100 – 0 – +100%         | +37%          |
| Sync       | Off, On                  | On            |
| Rate       |                          |               |
| Sync On:   | 16 – 8/4                 | 4T            |
| Sync Off:  | 0.01–10.0 Hz             | 2.54 Hz       |
| LFO Depth  | 0–100%                   | 61%           |
| Output     | -Inf dB – 0.0 dB         | 0.0 dB        |

Internal MPC Plugins now also support plugin preset expansion packs.

## Updates in MPC 2.13

### New Features

#### MPC Key 37 Support

MPC 2.13 adds support for the Akai Professional MPC Key 37 hardware. For a breakdown of MPC Key 37's controls, see [Features > MPC Key 37](#).

#### Feature Improvements

You can now select a project to automatically load each time you power on your standalone MPC. In the **Project Load/Save** tab of the [Preferences](#) menu, use the **Auto Load File** menu to select the desired project.

**Note:** If the New Project Dialog setting under **Project Defaults** is set to **Demo** or **Demo/Template/Recent**, selecting **Empty Project** will load the Auto Load project if one is selected. If no Auto Load project is selected, choosing **Empty project** will load an empty project. If you have an Auto Load project selected and would still like to create an empty project, press and hold **Shift** and then tap **Empty project**. If the **Project Defaults** is set to **Off**, the Auto Load project will be loaded on startup.

You can now download plugin instrument and effects content directly to the internal MPC storage drive. See [Operation > Menu > Preferences > Activate Plugins](#) to learn more.

The behavior of MPC hardware Undo buttons has been updated. When **Shift** is held, the Undo button will be fully lit if there is an action to Redo. If there is nothing to redo, the button will be dim.

In addition to MPC Key 37, MPC Key 61 now also includes a chord function. Play a chord on the keyboard and then press and hold **Shift** and press **Latch** to enable Chord Mode. Playing any note will now play the full chord transposed to the new note with a single key press. The first note played in the chord is considered the "home" note for transposition.



## Updates in MPC 2.15

### New Features

#### Stem Separation

MPC standalone hardware now supports Stem Separation, allowing you to easily split any track into distinct stems: vocals, bass, drums, and other instrumental elements.

To purchase MPC Stems, visit [akaipro.com/stems](http://akaipro.com/stems) and then activate your purchase in the **Menu > Preferences > Activate Plugins** menu.

#### To create stems of a sample:

1. First, add a sample to your project's sample pool using the **Browser**.
2. You can access the Create Stems function through Sample Edit Mode, or through Program Edit Mode.

#### To access Stems in Sample Edit Mode:

- i. Open **Sample Edit Mode** and select the sample to edit using the **Sample** field at the top of the window.
- ii. Tap the **Stems icon** at the top of the window.
- iii. Alternatively, you can tap the **Process** button at the bottom of the window to open the Process Samples window, and then select the **Create Stems** function. You can access this from any of Trim Mode, Chop Mode, or Program Mode.

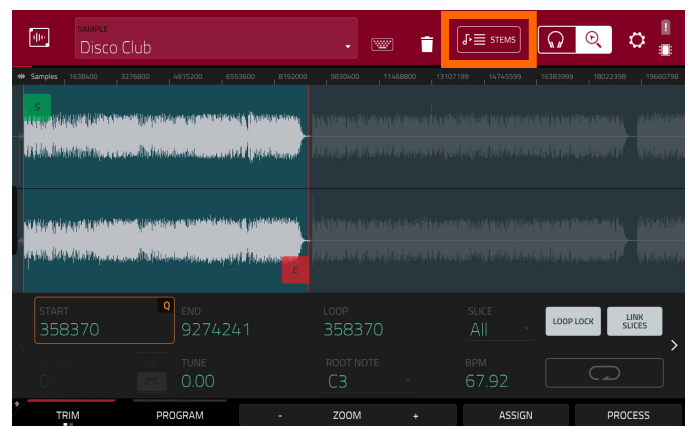

#### To access Stems in Program Edit Mode:

- i. Open **Program Edit Mode**.
- ii. Select a sample from a loaded Drum Program or Keygroup program.
- iii. Tap the **Create Stems icon** in the toolbar at the top of the screen.

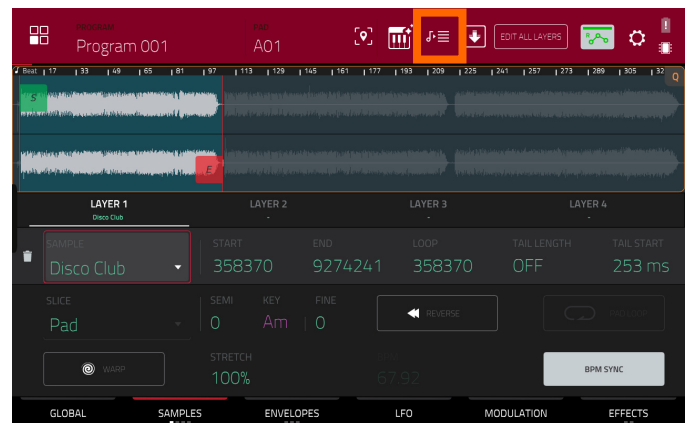

3. In the window that appears, use the following options to create your stems:

Click the icons to select or deselect from the following elements to create stems of:

- **Vocals:** Isolate vocal elements of the track into a stem.
- **Bass:** Isolate bass elements of the track into a stem.
- **Drums:** Isolate percussive elements of the track into a stem.
- **Other:** Isolate other musical textures, such as keys or guitars, into a stem.

Use the **Program** dropdown menu to select the program where the stems will be added.

The **Assign to Pad** function determines where the stem separated samples are added. When checked, you can select a pad in the chosen Program using the dropdown menu, and the stems will be added to the four layers of that pad. When unchecked, the stems will be added to the general project sample pool in the **Project Info** Browser.

Tap the **Use trimmed sample** box to trim the source sample between the **Start** and **End** points before applying the stem separation process.

Tap **Do It** to process the sample into stems, or tap **Cancel** to return to the previous page.

4. Once the process is complete, the new stemmed sample files will be added to the sample pool and any assigned pads, if selected.

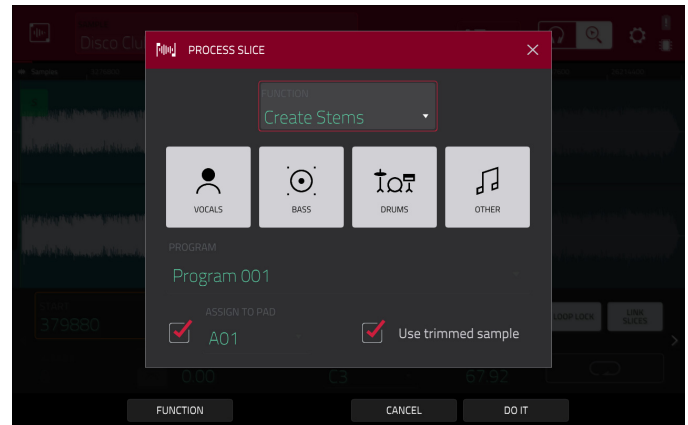

## Edit All Layers

When multiple stem elements are created and assigned to a pad, each element will be added to the pad as a separate sample layer. To easily edit these stems, a new **Edit All Layers** button has been added to the toolbar of **Program Edit Mode** when Drum or Keygroup programs are selected. When this is enabled, edits made to sample parameters such as **Start/End** points or **Semi/Fine** tuning on any one layer are automatically applied uniformly to all four layers at once (even if some layers are empty).

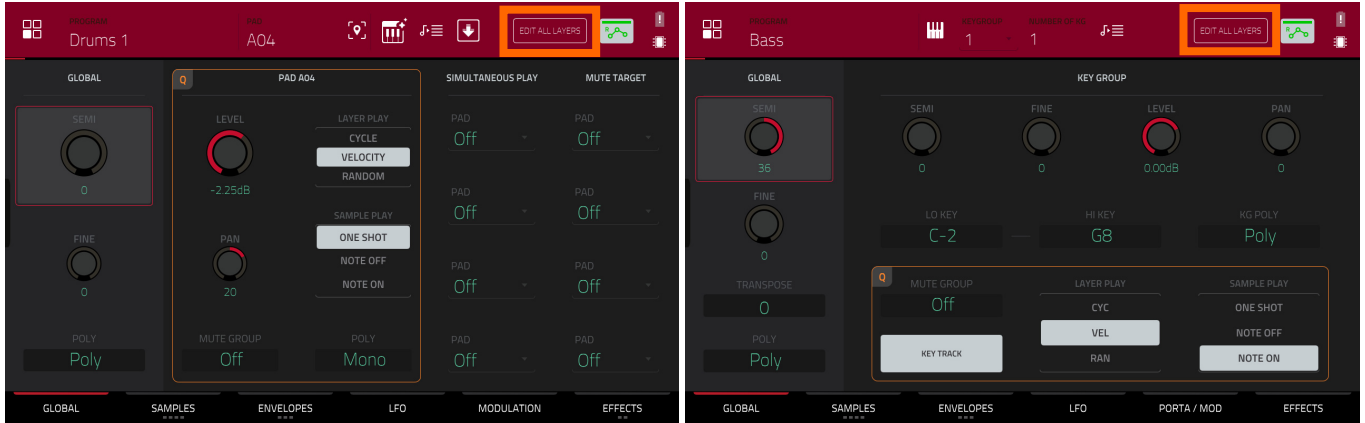

**AKAI**<sup>®</sup>  
PROFESSIONAL

---

[akaipro.com](http://akaipro.com)