

# DesignMax DM3SE

## surface-mounted loudspeaker

### Product Overview

With coaxial two-way drivers, the 30-watt DesignMax DM3SE loudspeaker offers clear, intelligible highs and surprising low end for its size — along with premium aesthetics that complement any commercial sound installation. The DM3SE features a two-way 3.5-inch woofer and .75-inch coaxial tweeter mounted within the Dispersion Alignment system, delivering a frequency range of 75 Hz - 20 kHz. The DM3SE is surface-mounted, IP55 outdoor-rated, and locks onto a hidden QuickHold U-bracket for fast, secure installation.



### Key Features

**Combine DesignMax models to complete any design, big or small** — 12 loudspeakers to mix and match, from 2-inch, low-profile models to 8-inch, high-SPL compression-driver loudspeakers and outdoor-rated options.

**Deliver clear highs and surprising low-end for their size** with coaxial two-way drivers — no DSP or EQ required. For even better sound, combine with select Bose DSPs and amplifiers to enable Bose loudspeaker EQ and SmartBass processing, which expands performance and response at any listening level.

**Ensure a consistent listening experience** throughout the room with the Dispersion Alignment system, which matches the coverage of the woofer to the pattern of the tweeter.

**Blend with any room design** with elegant form factors, minimum-bezel grilles available in black or white, and removable logos.

**Reduce installation time** with the patented QuickHold mounting system, which also reduces strain, hassle, and the chance of product damage.

**Install easily with industry-standard accessories** — all models include Euroblock connectors; in-ceiling models include plenum-rated backcans, tile bridges, and front-access audio wiring that makes installation and troubleshooting easier.

**Install DM3SE outside** — IP55 rating with standard aluminum grille for outdoor use.

### Technical Specifications

SINGLE LOUDSPEAKER PERFORMANCE		
Frequency Response (-3 dB) <sup>(1)</sup>	85 - 20,000 Hz	
Frequency Range (-10 dB) <sup>(1)</sup>	75 - 20,000 Hz	
Nominal Coverage (1 - 4 kHz)	140° conical	
Nominal Coverage Angle (1 - 10 kHz)	135° conical	
	AES component test <sup>(4)</sup>	Bose extended-lifecycle test <sup>(5)</sup>
Power Handling, long-term continuous	30 W	25 W
Power Handling, peak	120 W	100 W
Sensitivity (SPL / 1 W @ 1m) <sup>(2)</sup>	86 dB	86 dB
Calculated Maximum SPL @ 1 m <sup>(3)</sup>	101 dB	100 dB
Calculated Maximum SPL @ 1 m, peak	107 dB	106 dB
Crossover	1.7 kHz (passive 2-way crossover)	
Loudspeaker EQ	Not Required, Bose EQ voicing and SmartBass Processing available	
Recommended High-Pass Protection	80 Hz with recommended 24 dB / octave filter	
Transformer taps	70V: 3, 6, 12, 25 W, bypass 100V: 6, 12, 25 W, bypass	
TRANSDUCERS		
Low Frequency	1 × 83 mm woofer (3.25 in), weather-treated	
High Frequency	1 × 20 mm (0.75 in) neodymium dome tweeter, coaxially mounted, weather-treated	
Technology	Dispersion Alignment System, 127 mm (5 in) system diameter	
Nominal Impedance	8 ohms (transformer bypass)	

# DesignMax DM3SE

## surface-mounted loudspeaker

<b>PHYSICAL</b>	
Enclosure Material	Engineered plastics, highly UV fade resistant
Bracket Material	Powder-coated steel
Grille	Perforated aluminum with a powder coat finish, tamper-resistant design, paintable
Logo	Rotatable, removable
Color	Black: RAL 9005, White: Bose Arctic White, similar to RAL 9003, Paintable
Environmental / Ingress-Protection	Outdoor per IEC 529 IP55 (suitable for use outdoors in wet locations), includes aluminum grille to prevent red corrosion and weather resistant input cover
Safety Agency	UL-1480A, S5591/ UL Listed, NFPA70, CE compliant
Operating Temperature Range	-25 °C to 70 °C (-13 °F to 158 °F)
Connectors	Euroblock 6-pin connector with loop-through, mounted on rear. Accepts 18 AWG (0.8 mm <sup>2</sup> ) to 14 AWG (2.5 mm <sup>2</sup> ) size wire
Suspension / Mounting	QuickHold Mounting System with included U-Bracket
	4 preset mounting angles: 0°, 15°, 30°, 45° for wall or ceiling placement
	Two (2) rear M6 screw inserts for use with optional pan & tilt bracket and one (1) rear M6 screw insert for safety-tether attachment
Dimensions (H × W × D)	232 × 154 × 155 mm (9.1 × 6.1 × 6.1 in)
Dimensions with Bracket (H × W × D)	232 × 154 × 171 mm (9.1 × 6.1 × 6.7 in)
Net Weight, Loudspeaker with grille (single)	2.5 kg (5.6 lb)
Shipping Weight (pair)	7.2 kg (16.0 lbs)
Included Accessories	U-Bracket, powder-coated steel
Optional Accessories	Pan & Tilt Bracket
<b>PRODUCT CODES</b>	
829712-0110	DESIGNMAX DM3SE PAIR BLK
829712-0210	DESIGNMAX DM3SE PAIR WHT

#### Footnotes

- (1) Frequency response and range measured on-axis in half-space environment with Bose EQ voicing
- (2) Sensitivity measured on-axis in half-space environment averaged 100 Hz - 10 kHz using recommended High-Pass protection
- (3) Maximum SPL calculated from sensitivity and power handling specifications, exclusive of power compression.
- (4) AES standard 2-hour duration with IEC system noise
- (5) Bose extended-lifecycle test using pink noise filtered to meet IEC268-5, 6-dB crest factor, 500-hour duration.
- (6) Measured in whole-space environment

For additional specifications and application information, please visit [PRO.BOSE.COM](http://PRO.BOSE.COM).  
Specifications subject to change without notice. 09/2020

# DesignMax DM3SE

## surface-mounted loudspeaker

### On-Axis Frequency Response

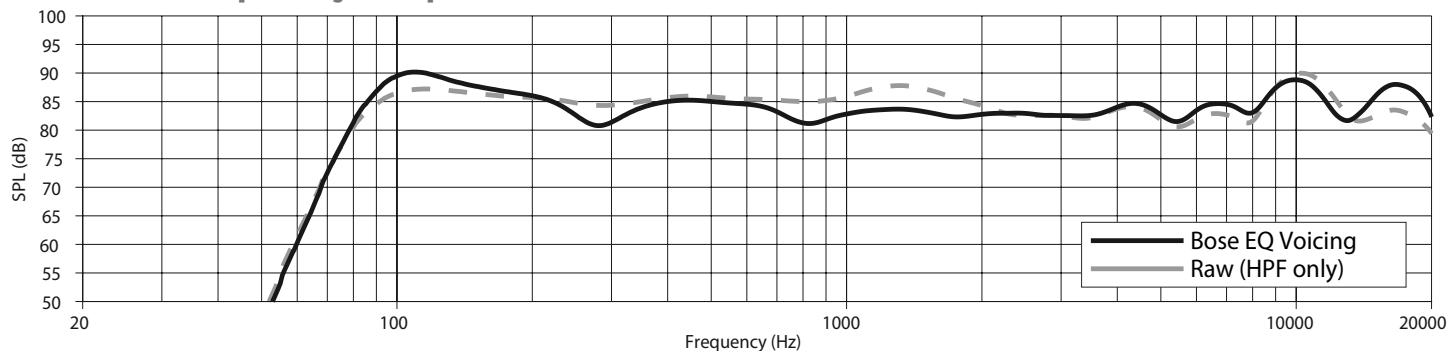

### Impedance

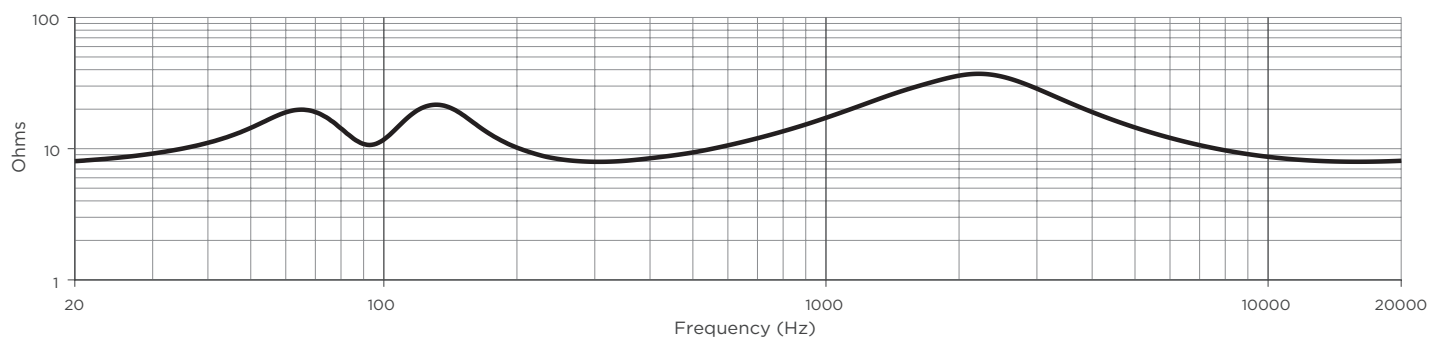

### Beamwidth <sup>6</sup>

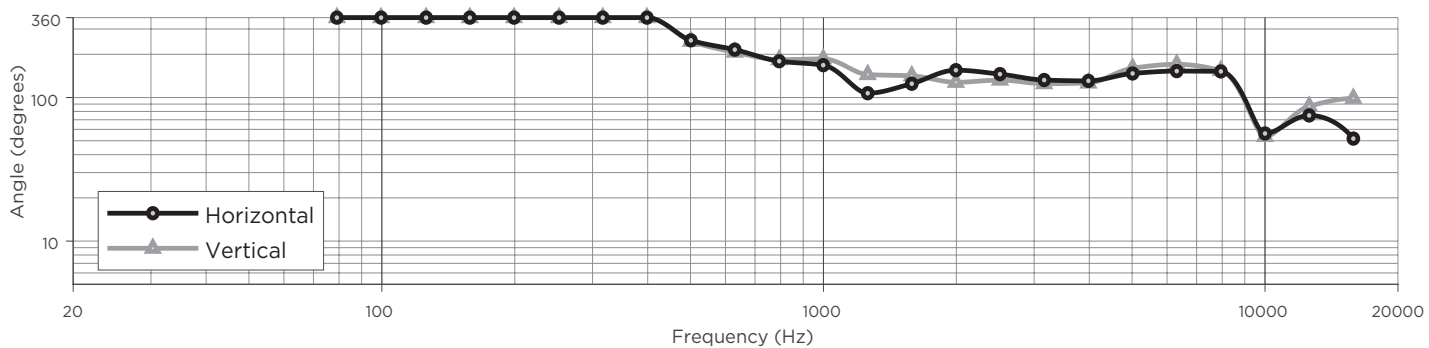

For additional specifications and application information, please visit [PRO.BOSE.COM](http://PRO.BOSE.COM). Specifications subject to change without notice. 09/2020

# DesignMax DM3SE

## surface-mounted loudspeaker

### Dimensions

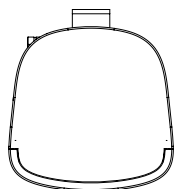

**Top View**

LOCK FORK

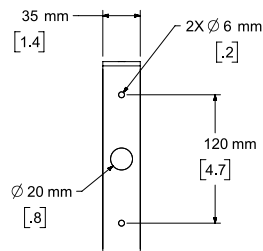
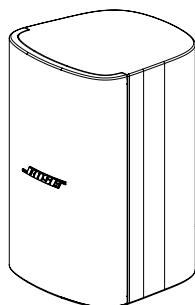

**Rear View**  
BRACKET ONLY

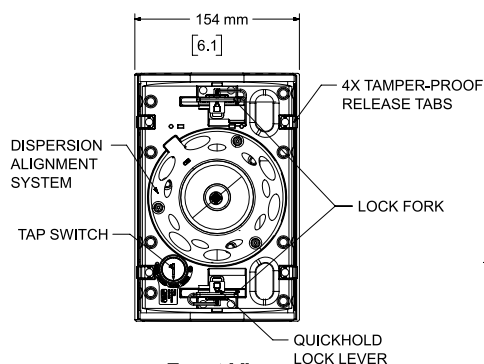

**Front View**  
GRILLE REMOVED FOR CLARITY

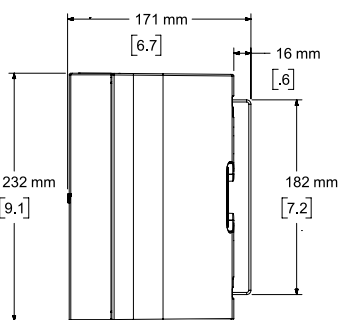

**Right View**  
DIMENSIONS APPLY TO BOTH SIDES

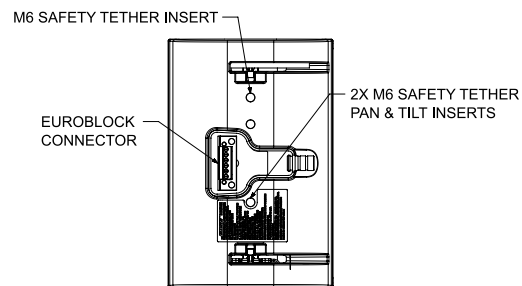

**Rear View**  
BRACKET/INPUT COVER REMOVED FOR CLARITY

- NOTES:
1. DIMENSIONS ARE IN MILLIMETERS OVER INCHES
  2. WEIGHT 2.5kg [5.6lbs] (SPEAKER ONLY)  
WEIGHT W/BRACKET 2.8kg [6.1lbs]

For additional specifications and application information, please visit [PRO.BOSE.COM](http://PRO.BOSE.COM).  
Specifications subject to change without notice. 09/2020