



AV Receiver

**RX-V685**

**Owner's Manual**

musicCast

- 
- This unit is a product for enjoying video and music at home.
  - This manual explains preparations and operations for everyday users of the unit.
  - Read the supplied booklet "Quick Start Guide" before using the unit.

# CONTENTS

## BEFORE USING THE UNIT 8

### How to use this manual..... 8

How to use this manual..... 8

### Checking the accessories..... 8

Checking the accessories..... 8

### Using the remote control..... 8

Insert the batteries in the remote control..... 8

Operating range of the remote control..... 8

## FEATURES 9

### What you can do with the unit..... 9

### Part names and functions..... 11

Part names and functions of the front panel..... 11

Part names and functions of the front display..... 13

Part names and functions of the rear panel..... 14

Part names and functions of the remote control..... 15

## PREPARATIONS 16

### 1 Connecting speakers..... 16

Names and functions of speakers..... 16

Speaker systems and speakers to be connected..... 17

Speaker requirements..... 17

Setting the speaker impedance..... 18

Cable requirements..... 18

How to connect speakers..... 18

How to place speakers (speaker systems)..... 20

Advanced speaker systems..... 26

### 2 Connecting a TV..... 29

HDMI connection with a TV..... 29

HDMI connection with another TV or a projector..... 29

### 3 Connecting playback devices..... 30

HDMI connection with a video device such as a BD/DVD player..... 30

Connection other than HDMI with a playback device..... 30

Connecting to the jack on the front panel..... 32

### 4 Connecting the FM/AM antennas..... 32

Connecting the FM/AM antennas..... 32

### 5 Preparing for connecting to a network..... 33

Preparing for connecting to a network..... 33

Connecting a network cable (wired connection)..... 33

Preparing wireless antennas (wireless connection)..... 34

### 6 Connecting other devices..... 34

Connecting an external power amplifier..... 34

Connecting a device compatible with the trigger function..... 35

### 7 Plugging in the power cable..... 35

Plugging in the power cable..... 35

### 8 Selecting the on-screen menu language..... 36

Selecting the on-screen menu language..... 36

### 9 Configuring the necessary speaker settings..... 37

Assigning speaker configuration..... 37

Optimizing the speaker settings automatically (YPAO)..... 38

Checking the YPAO measurement results..... 40

Reloading the previous YPAO adjustments..... 41

Error messages from YPAO..... 42

Warning messages from YPAO..... 43

### 10 Setting MusicCast..... 44

What is MusicCast..... 44

Using MusicCast CONTROLLER..... 44

Adding the unit to the MusicCast network..... 44

## ENJOYING SOUND 45

<b>Enjoying sound field effects.....</b>	<b>45</b>
Select your favorite sound mode.....	45
Enjoying 3D sound fields (CINEMA DSP 3D).....	45
Enjoying sound field effects optimized for the type of content.....	46
Enjoying sound field effects without surround speakers (Virtual CINEMA DSP).....	46
Enjoying surround sound with 5 speakers placed in front (Virtual CINEMA FRONT).....	46
Enjoying surround sound with headphones (SILENT CINEMA).....	46
<b>Enjoying unprocessed playback.....</b>	<b>47</b>
Enjoying original sound (straight decode).....	47
Enjoying multichannel playback without sound field effects (surround decoder).....	47
Enjoying pure high fidelity sound (Pure Direct).....	48
<b>Enjoying enhanced bass sound.....</b>	<b>49</b>
Enhancing the bass (Extra Bass).....	49
<b>Enjoying enhanced compressed music.....</b>	<b>49</b>
Playing back digitally compressed formats with enriched sound (Compressed Music Enhancer).....	49
<b>Enjoying Dolby Atmos® and DTS:X™.....</b>	<b>50</b>
Enjoying Dolby Atmos® and DTS:X™.....	50
<b>Enjoying music in multiple rooms.....</b>	<b>51</b>
Playing back music in multiple rooms.....	51
Connecting Zone2 speakers.....	51
Operating the unit from Zone2 (remote connection).....	53
Controlling Zone2.....	54
Enjoying the same source in multiple rooms (party mode).....	55

## PLAYBACK 56

<b>Basic playback procedure.....</b>	<b>56</b>
Basic procedure for playing back video and music.....	56
Selecting an HDMI output jack.....	57
Switching information on the front display.....	57
Item names and functions of the playback screen.....	58
Item names and functions of the browse screen.....	59

<b>Listening to FM/AM radio.....</b>	<b>60</b>
Setting the frequency steps.....	60
Selecting a frequency for reception.....	61
Selecting a preset station.....	62
Registering FM radio stations automatically (FM Auto Preset).....	62
Registering a radio station manually.....	63
Clearing preset stations.....	64
Clearing all preset stations.....	64
Displaying the Radio Data System information.....	65
Receiving traffic information automatically.....	65
<b>Playing back music stored on a Bluetooth® device.....</b>	<b>66</b>
Playback Bluetooth® device music on the unit.....	66
<b>Playing back music with AirPlay.....</b>	<b>67</b>
Playback of iTunes/iPhone music contents with AirPlay.....	67
<b>Playing back music stored on a USB storage device.....</b>	<b>68</b>
Playback of USB storage device contents.....	68
<b>Playing back music stored on media servers (PCs/NAS).....</b>	<b>69</b>
Media sharing setup on media servers (PCs/NAS).....	69
Playing back music stored on media servers (PCs/NAS).....	69
<b>Listening to Internet radio.....</b>	<b>71</b>
Selecting an Internet radio station.....	71
Registering favorite Internet radio stations.....	71
<b>Listening to music streaming services.....</b>	<b>72</b>
Listening to a streaming service.....	72
<b>Useful playback functions.....</b>	<b>73</b>
SCENE function.....	73
Shortcut function.....	76

<b>Configuring playback settings for different playback sources (Option menu).....</b>	<b>78</b>
Basic operation of the Option menu.....	78
Option menu items.....	79
Adjusting the tone of the audio output.....	79
Configuring the volume automatically based on the YPAO measurement results.....	80
Adjusting the volume or perceive height of dialogue sounds.....	81
Adjusting the delay of the Lipsync function.....	82
Setting Compressed Music Enhancer.....	82
Correcting volume differences during playback.....	82
Setting the use of Extra Bass.....	83
Enabling the video signal processing.....	83
Selecting a video source to be output with the selected audio source.....	83
Configuring the shuffle/repeat setting.....	84
Switching between stereo and monaural for FM radio reception.....	84
Setting presets for radio stations.....	85
Adding an Internet radio station to the "Favorites" folder.....	87
Removing an Internet radio station from the "Favorites" folder.....	87
Receiving traffic information automatically.....	87
Checking the current status information.....	88

## **CONFIGURATIONS 89**

<b>Configuring various functions (Setup menu).....</b>	<b>89</b>
Basic operation of the Setup menu.....	89
Setup menu items.....	90

<b>Configuring the speaker settings.....</b>	<b>94</b>
Setting your speaker system.....	94
Setting the size of the front speakers.....	94
Setting the use of a center speaker and its size.....	95
Setting the use of surround speakers and their size.....	95
Setting the layout of the surround speakers.....	96
Setting the use of surround back speakers and their size.....	96
Setting the use of presence speakers and their size.....	97
Setting the layout of the presence speakers.....	97
Setting the crossover frequency of the low-frequency components.....	97
Setting the use of a subwoofer.....	98
Setting the phase of the subwoofer.....	98
Setting the distance between each speaker and the listening position.....	98
Adjusting the volume of each speaker.....	99
Setting the equalizer.....	99
Outputting test tones.....	100
Reloading the previous YPAO adjustments.....	100

## Configuring the sound settings..... 101

Checking the current audio signal information.....	101
Enabling Lipsync adjustment.....	101
Setting the adjustment method of the Lipsync function.....	102
Adjusting the delay of the Lipsync function.....	102
Selecting sound programs.....	103
Adjusting the sound field effect level.....	104
Adjusting the delay between the direct sound and presence sound field generation.....	104
Adjusting the broadening effect of the presence sound field.....	104
Adjusting the loss of the presence sound field.....	105
Adjusting the decay time of the rear reverberant sound.....	105
Adjusting the delay between the direct sound and reverberant sound generation.....	105
Adjusting the volume of the reverberant sound.....	105
Adjusting the delay between the direct sound and surround sound field generation.....	106
Adjusting the broadening effect of the surround sound field.....	106
Adjusting the loss of the surround sound field.....	106
Adjusting the delay between the direct sound and surround back sound field generation.....	106
Adjusting the broadening effect of the surround back sound field.....	107
Adjusting the loss of the surround back sound field.....	107
Selecting the surround decoder used in the program.....	107
Setting the use of Center Spread.....	108
Adjusting the center localization (broadening effect) of the front sound field.....	108
Adjusting the entire volume for "7ch Stereo".....	108
Adjusting the front and rear volume balance for "7ch Stereo".....	108
Adjusting the left and right volume balance for "7ch Stereo".....	108
Adjusting the height volume balance using the presence speakers for "7ch Stereo".....	109
Setting the use of Monaural Mix for "7ch Stereo".....	109
Setting the dynamic range adjustment method.....	109
Setting the limit value of the volume.....	109
Setting the initial volume for when the unit is turned on.....	110
Adjusting the CINEMA DSP 3D effect level automatically.....	110
Setting Virtual Surround Back Speaker (VSBS).....	110

## Configuring the scene settings..... 111

Selecting items to be included as the scene assignments.....	111
Renaming the SCENE name.....	112

## Configuring the video/HDMI settings..... 113

Checking the current video and HDMI signal information.....	113
Setting the use of the video signal processing.....	113
Setting a resolution to output HDMI video signals.....	113
Setting an aspect ratio to output HDMI video signals.....	114
Setting the use of HDMI Control.....	114
Setting the audio jack used for TV audio input.....	114
Setting the use of ARC.....	114
Linking the standby modes of the unit and the TV.....	115
Setting the output of HDMI audio from the TV speaker.....	115
Setting the version of HDCP used on the HDMI input jacks.....	115
Setting the use of HDMI Standby Through.....	115

## Configuring the network settings..... 116

Checking the network information on the unit.....	116
Setting the network connection method (Wired/Wireless).....	116
Setting the network parameters automatically (DHCP).....	116
Setting the network parameters manually.....	117
Setting the use of the Network Standby function.....	117
Setting the MAC address filter.....	118
Setting the MAC address.....	118
Setting the use of a Digital Media Controller.....	118
Setting the use of volume control via AirPlay.....	118
Setting the network name of the unit.....	119
Setting the power interlock from the unit to MusicCast compatible devices.....	119

## Configuring the Bluetooth® settings..... 120

Setting the use of Bluetooth®.....	120
Terminating the connection between a Bluetooth® device and the unit.....	120
Setting the use of the Bluetooth® Standby function.....	120

<b>Configuring the multi zone settings.....</b>	<b>121</b>
Checking the Zone2 information.....	121
Setting the use of volume adjustments for Zone2 output.....	121
Setting the Zone2 limit value of the volume.....	121
Setting the Zone2 initial volume for when the unit is turned on.....	122
Adjusting the time deviation in relation to the main zone.....	122
Switching between stereo and monaural for Zone2 output.....	122
Setting the use of Compressed Music Enhancer for Zone2 output.....	123
Adjusting the tone for Zone2 output.....	123
Setting the use of Extra Bass for Zone2 output.....	123
Adjusting the volume balance for Zone2 output.....	123
Renaming the zone name.....	124
Setting the use of switching to the party mode on Zone2.....	124
<b>Configuring the system settings.....</b>	<b>125</b>
Checking the system information on the unit.....	125
Setting the on-screen menu language.....	125
Combining audio of another input source with video of the current input source.....	126
Setting input sources to be skipped when operating the INPUT key.....	127
Automatically changing the input source names displayed on the front display.....	128
Manually changing the input source names displayed on the front display.....	128
Setting the use of Auto Play function.....	129
Setting sound programs to skip when operating the PROGRAM key.....	129
Setting the function for the PROGRAM key on the remote control.....	129
Setting the unit's functions for the RED/GREEN/YELLOW/BLUE keys of the remote control.....	130
Adjusting the brightness of the front display.....	130
Setting the scale of the volume display.....	130
Setting the use of short messages on the TV.....	130
Setting the image to be used as wallpaper on the TV.....	130
Specifying the condition for the TRIGGER OUT jack to function.....	131
Specifying the output level of the electronic signal transmitted with each input.....	131
Switching the output level for electronic signal transmission manually.....	131
Specifying the zone with which the TRIGGER OUT jack functions are synchronized.....	131
Setting the amount of time for the auto-standby function.....	132
Setting the use of the eco mode.....	132
Preventing accidental changes to the settings.....	132
Updating the firmware via the network.....	133

<b>Configuring the advanced settings (ADVANCED SETUP menu).....</b>	<b>134</b>
Basic operation of the ADVANCED SETUP menu.....	134
ADVANCED SETUP menu items.....	134
Changing the speaker impedance setting (SP IMP.).....	135
Selecting the remote control ID (REMOTE ID).....	135
Changing the FM/AM tuning frequency setting (TU).....	135
Switching the video signal type (TV FORMAT).....	135
Removing the limitation on HDMI video output (MON.CHK).....	136
Selecting the HDMI 4K signal format (4K MODE).....	136
Setting DTS Format Notification (DTS MODE).....	137
Backing up and restoring all the settings (BKUP/RSTR).....	137
Restoring the default settings (INIT).....	138
Updating the firmware (UPDATE).....	138
Checking the firmware version (VERSION).....	138

## **TROUBLESHOOTING 139**

<b>When any problem appears.....</b>	<b>139</b>
If trouble occurs, first check the following:.....	139
Power, system, or remote control trouble.....	139
Audio trouble.....	141
Video trouble.....	144
FM/AM radio trouble.....	145
USB trouble.....	145
Network trouble.....	146
Bluetooth® trouble.....	148
<b>Error indications on the front display.....</b>	<b>149</b>
Error indications on the front display.....	149

## **APPENDIX 151**

<b>Updating the unit's firmware via the network.....</b>	<b>151</b>
Firmware updates.....	151
Updating the unit's firmware via the network.....	152

<b>Connecting to a network wirelessly.....</b>	<b>153</b>	<b>Default settings.....</b>	<b>178</b>
Selecting a wireless network connection method.....	153	Default settings of the Option menu.....	178
Setting up a wireless connection using the WPS button.....	154	Default settings of the Setup menu.....	178
Setting up a wireless connection using an iOS device.....	154	Default settings of the ADVANCED SETUP menu.....	180
Setting up a wireless connection by selecting from the list of available access points.....	156		
Setting up a wireless connection manually.....	157		
Setting up a wireless connection by using the WPS PIN code.....	159		
<b>Input/output jacks and cables.....</b>	<b>160</b>		
Video/audio jacks.....	160		
Video jacks.....	160		
Audio jacks.....	161		
<b>Using presence speakers.....</b>	<b>162</b>		
Presence speaker layout.....	162		
Installing the presence speakers in Front Height position.....	162		
Installing the presence speakers in Overhead position.....	162		
Using Dolby Enabled speakers as the presence speakers.....	163		
<b>Glossary.....</b>	<b>164</b>		
Glossary of audio information.....	164		
Glossary of HDMI and video information.....	165		
Glossary of network information.....	166		
Glossary of Yamaha technologies.....	166		
<b>Supported devices and file formats.....</b>	<b>167</b>		
Supported Bluetooth® devices.....	167		
Supported USB devices.....	167		
Supported AirPlay devices.....	167		
Supported file formats.....	168		
<b>Video signal flow.....</b>	<b>168</b>		
Video signal flow.....	168		
Video conversion table.....	169		
<b>Additional information on HDMI.....</b>	<b>170</b>		
HDMI Control and synchronized operations.....	170		
Audio Return Channel (ARC).....	171		
HDMI signal compatibility.....	172		
<b>Trademarks.....</b>	<b>173</b>		
Trademarks.....	173		
<b>Specifications.....</b>	<b>174</b>		
Specifications.....	174		

# BEFORE USING THE UNIT

## How to use this manual

### How to use this manual

When reading this manual, mind the following items.

- Some features are not available in certain regions.
- Due to product improvements, specifications and appearance are subject to change without notice.
- This manual mainly explains operations using the menu displayed on the TV screen. Operations with the TV screen menu are only available when your TV is connected to the unit via HDMI.
- This manual explains operations using the supplied remote control.
- This manual describes all the "iPod touch", "iPhone" and "iPad" as the "iPhone". "iPhone" refers to "iPod touch", "iPhone" and "iPad", unless otherwise specified.

#### **Warning:**

Indicates precautions for the possibility of death or serious injury.

#### **Caution:**

Indicates precautions for the possibility of minor or moderate injury.

#### **Notice:**

Indicates precautions for use to avoid the possibility of malfunction/damage to the unit.

#### **Note:**

Indicates instructions and supplementary explanations for optimum use.

## Checking the accessories

### Checking the accessories

Check that the following accessories are supplied with the product.

AM antenna



FM antenna

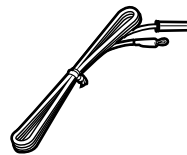
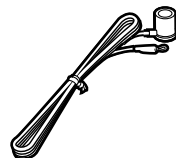

YPAO microphone

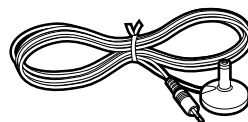

\* One of the above is supplied depending on the region of purchase.

Remote control

Batteries (AAA, R03, UM-4) (x2)

Quick Start Guide

#### **Note**

Access the Yamaha Downloads site to download the latest Owner's Manual and Quick Start Guide.  
<http://download.yamaha.com/>

## Using the remote control

### Insert the batteries in the remote control

Insert the batteries the right way round.

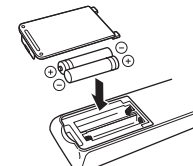

### Operating range of the remote control

Point the remote control at the remote control sensor on the unit and remain within the operating range shown in the following figure.

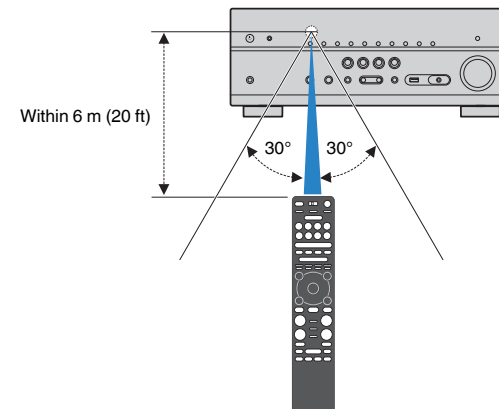



# FEATURES

## What you can do with the unit

### Supporting 2- to 7.1-channel speaker system

According to the number of speakers that you are using, you can enjoy your favorite acoustic spaces in various styles.

- “Using 7.1/5.1.2-channel system” (p.20)
- “Using 5.1.2-channel system” (p.21)
- “Using 7.1-channel system” (p.22)
- “Using 5.1-channel system” (p.23)
- “Using 3.1.2-channel system” (p.24)
- “Using Virtual CINEMA FRONT” (p.25)
- “Playing back music in multiple rooms” (p.51)

### Automatically optimizing the speaker settings (YPAO)

YPAO function detects speaker connections, measures the distances from them to your listening position by using YPAO microphone measurement, and then automatically optimizes the speaker settings, such as volume balance and acoustic parameters, to suit your room (YPAO: Yamaha Parametric room Acoustic Optimizer).

- “Optimizing the speaker settings automatically (YPAO)” (p.38)

### Enjoying sound field effects with much presence

The unit is equipped with a variety of sound programs and surround decoders that allow you to enjoy playback sources with your favorite sound mode (such as sound field effect or stereo playback).

- “Enjoying 3D sound fields (CINEMA DSP 3D)” (p.45)
- “Enjoying sound field effects optimized for the type of content” (p.46)
- “Enjoying sound field effects without surround speakers (Virtual CINEMA DSP)” (p.46)
- “Enjoying surround sound with headphones (SILENT CINEMA)” (p.46)
- “Enjoying original sound (straight decode)” (p.47)
- “Enjoying multichannel playback without sound field effects (surround decoder)” (p.47)
- “Enjoying pure high fidelity sound (Pure Direct)” (p.48)
- “Enhancing the bass (Extra Bass)” (p.49)
- “Playing back digitally compressed formats with enriched sound (Compressed Music Enhancer)” (p.49)
- “Enjoying Dolby Atmos® and DTS:X™” (p.50)

### Wide variety of supported content via network

When the unit is connected to a network, you can enjoy the various kinds of content via network on the unit.

- “Playback of iTunes/iPhone music contents with AirPlay” (p.67)
- “Playing back music stored on media servers (PCs/NAS)” (p.69)
- “Selecting an Internet radio station” (p.71)
- “Listening to a streaming service” (p.72)

### Playing back content of various devices

A number of HDMI jacks and various input/output jacks on the unit allow you to connect video devices (such as BD/DVD players), audio devices (such as CD players), Bluetooth devices (such as smartphones), game consoles, USB storage devices, and other devices. You can play back content of them.

- “Selecting a frequency for reception” (p.61)
- “Playback Bluetooth® device music on the unit” (p.66)
- “Playback of USB storage device contents” (p.68)

## Useful functions

---

The unit is equipped with the various useful functions. The SCENE function allows you to select the input source and settings registered to the corresponding scene, such as sound program and Compressed Music Enhancer on/off, with just one touch. When the unit is connected to an HDMI Control-compatible TV with an HDMI cable, you can control the unit (such as power and volume) with TV remote control operations.

- “Selecting the input source and favorite settings with one touch (SCENE)” (p.73)
- “Registering a favorite content as shortcut” (p.76)
- “HDMI Control and synchronized operations” (p.170)
- “Audio Return Channel (ARC)” (p.171)

## Useful applications

### Application: “AV SETUP GUIDE”

---



AV SETUP GUIDE is an application that assists you with cable connections between AV Receiver and playback devices as well as AV Receiver setup. This app guides you through the various settings such as speaker connections, TV and playback device connections and selecting the speaker system.

For details, search for “AV SETUP GUIDE” on the App Store or Google Play.

### Application: “AV CONTROLLER”

---



AV CONTROLLER is an application that assists you with various operations of AV Receiver without the remote control. This app allows you not only to control the unit's power and volume but also to select the input source and start/stop playback.

For details, search for “AV CONTROLLER” on the App Store or Google Play.

## Application: “MusicCast CONTROLLER”

---



MusicCast CONTROLLER is an application that allows you to link a MusicCast compatible device to other MusicCast compatible devices in other rooms and play them back simultaneously. This app lets you use your smartphone or other mobile device instead of the remote control to easily select music to play back as well as configure the unit and MusicCast compatible devices.

For details, search for “MusicCast CONTROLLER” on the App Store or Google Play.

## Part names and functions of the front panel

The part names and functions of the front panel are as follows.

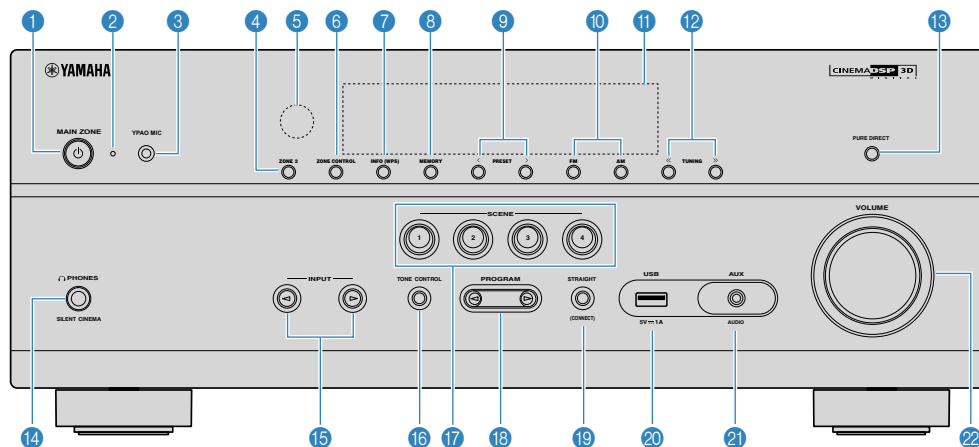

### 1 MAIN ZONE key

Turns on/off (standby) the unit.

### 2 Standby indicator

Lights up when the unit is in standby mode under any of the following conditions.

- HDMI Control is enabled (p.114)
- Standby Through is enabled (p.115)
- Network Standby is enabled (p.117)
- Bluetooth Standby is enabled (p.120)

### 3 YPAO MIC jack

For connecting the supplied YPAO microphone (p.38).

### 4 ZONE 2 key

Enables/disables the audio output to Zone2 (p.54).

### 5 Remote control sensor

Receives remote control signals (p.8).

### 6 ZONE CONTROL key

Changes the zone (main zone or the Zone2) that is controlled by the keys and knobs on the front panel (p.54).

### 7 INFO (WPS) key

Selects the information displayed on the front display (p.57).

Enters the wireless LAN connection setup (WPS button configuration) by holding down for a few seconds (p.154).

### 8 MEMORY key

Registers FM/AM radio stations as preset stations (p.62).

Registers Bluetooth, USB, or network content as a shortcut by holding down for a few seconds (p.76).

### 9 PRESET keys

Select a preset FM/AM radio station (p.62).

Recall Bluetooth, USB, or network content that is registered as a shortcut (p.77).

### 10 FM and AM keys

Switch between FM and AM (p.61).

### 11 Front display

Displays information (p.13).

### 12 TUNING keys

Select the radio frequency (p.61).

### 13 PURE DIRECT key

Enables/disables the Pure Direct (p.48).

### 14 PHONES jack

For connecting headphones.

### 15 INPUT keys

Select an input source.

### 16 TONE CONTROL key

Adjusts the level of high-frequency range (Treble) and low-frequency range (Bass) individually (p.79).

**17 SCENE keys**

Switch with one touch between multiple settings set using the SCENE function. Also, turns on the unit when it is in standby mode (p.73).

**18 PROGRAM keys**

Select a sound program or a surround decoder (p.45).

**19 STRAIGHT (CONNECT) key**

Enables/disables the straight decode mode (p.47).

Enters the MusicCast network addition and the wireless LAN setup by holding down for 5 seconds (p.44).

**20 USB jack**

For connecting a USB storage device (p.68).

**21 AUX jack**

For connecting devices, such as portable audio players (p.32).

**22 VOLUME knob**

Adjusts the volume.

## Part names and functions of the front display

The part names and functions of the front display are as follows.

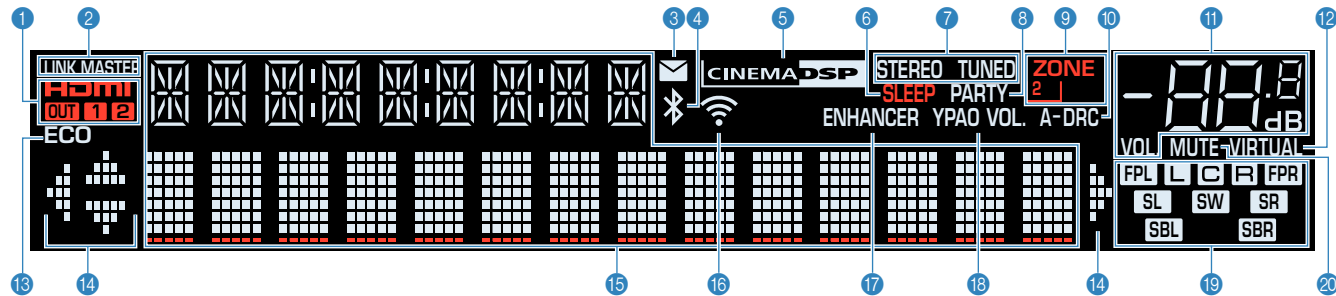

### 1 HDMI

Lights up when HDMI signals are being input or output.

#### OUT1/OUT2

Indicates the HDMI OUT jacks currently outputting an HDMI signal.

### 2 LINK MASTER

Lights up when the unit is the master device of the MusicCast network.

### 3 Firmware update indicator

Lights up when a firmware update is available via the network.

### 4 Bluetooth indicator

Light up while the unit is connected to a Bluetooth device.

### 5 CINEMA DSP

Lights up when CINEMA DSP 3D (p.45) is working.

### 6 SLEEP

Lights up when the sleep timer is on.

### 7 STEREO

Lights up when the unit is receiving a stereo FM radio signal.

#### TUNED

Lights up when the unit is receiving an FM/AM radio station signal.

### 8 PARTY

Lights up when the party mode (p.55) is enabled.

### 9 ZONE2

Lights up when audio output to Zone2 (p.54) is enabled.

### 10 A-DRC

Lights up when Adaptive DRC (p.80) is working.

### 11 Volume indicator

Indicates the current volume.

### 12 VIRTUAL

Lights up when the virtual processing is working (p.45) .

### 13 ECO

Lights up when the eco mode (p.132) is enabled.

### 14 Cursor indicators

Indicate the remote control cursor keys currently operational.

### 15 Information display

Displays the current status (such as input name and sound mode name). You can switch the information by pressing INFO (p.57).

### 16 Wireless LAN indicator

Light up while the unit is connected to a wireless network (p.153).

#### Note

This indicator may light up when the unit is added to the MusicCast network. For details, see "Adding the unit to the MusicCast network" (p.44).

### 17 ENHANCER

Lights up when Compressed Music Enhancer (p.49) is working.

### 18 YPAO VOL.

Lights up when YPAO Volume (p.80) is enabled.

### 19 Speaker indicators

Indicate speaker terminals from which signals are output.

**L** Front speaker (L)

**R** Front speaker (R)

**C** Center speaker

**SL** Surround speaker (L)

**SR** Surround speaker (R)

**SBL** Surround back speaker (L)

**SBR** Surround back speaker (R)

**FPL** Presence speaker (L)

**FPR** Presence speaker (R)

**SW** Subwoofer

### 20 MUTE

Blinks when audio is temporarily muted.

## Part names and functions of the rear panel

The part names and functions of the rear panel are as follows.

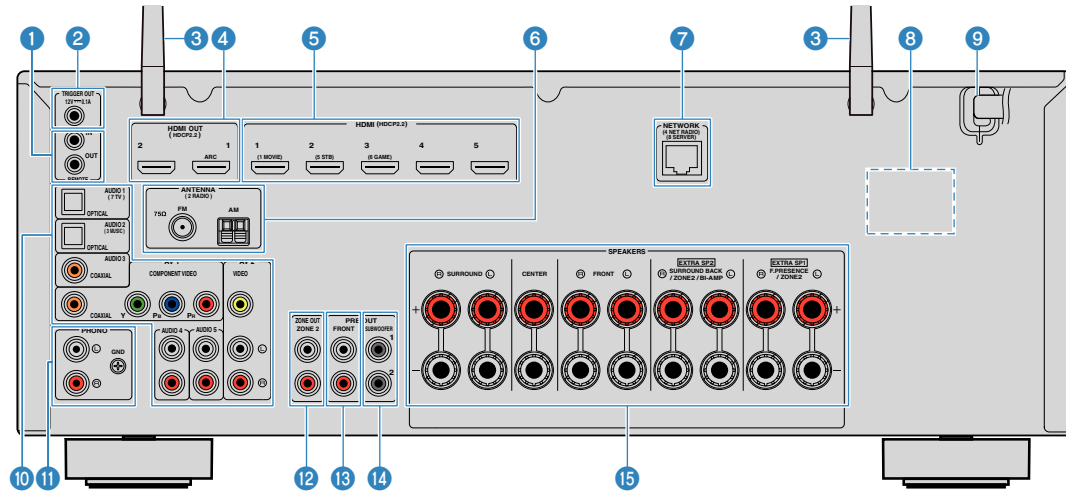

• The area around the video/audio output jacks is marked in white on the actual product to prevent improper connections.

### 1 REMOTE IN/OUT jacks

For connecting to an infrared signal receiver/emitter that allows you to operate the unit and other devices from another room (p.53).

### 2 TRIGGER OUT jack

For connecting to a device that supports the trigger function (p.35).

### 3 Wireless antennas

For a wireless (Wi-Fi) connection to a network (p.153) and a Bluetooth connection (p.66).

### 4 HDMI OUT 1–2 jacks

For connecting to HDMI-compatible TVs and outputting video/audio signals (p.29). When using ARC, TV audio signal can also be input through the HDMI OUT 1 jack.

### 5 HDMI 1–5 jacks

For connecting to HDMI-compatible playback devices and inputting video/audio signals (p.30).

### 6 ANTENNA jacks

For connecting to FM and AM antennas (p.32).

### 7 NETWORK jack

For a wired connection to a network (p.33).

### 8 VOLTAGE SELECTOR

(Taiwan, Brazil and Central and South America models only)  
Selects the switch position according to your local voltage (p.35).

### 9 Power cable

For connecting to an AC wall outlet (p.35).

### 10 AV jacks AUDIO jacks

For connecting to video/audio playback devices and inputting video/audio signals (p.31).

### 11 PHONO jacks

For connecting to a turntable (p.31).

### 12 ZONE OUT jacks

For connecting to the external amplifier used in Zone2 and for outputting audio (p.53).

### 13 PRE OUT jacks

For connecting to an external power amplifier (p.34).

### 14 SUBWOOFER jack

For connecting to a subwoofer (with built-in amplifier) (p.19).

### 15 SPEAKERS terminals

For connecting to speakers (p.16).

# Part names and functions of the remote control

The part names and functions of the supplied remote control are as follows.

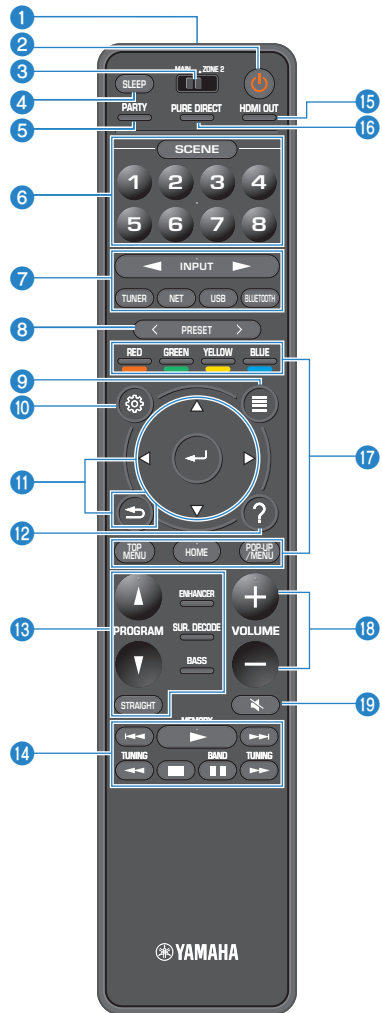

## 1 Remote control signal transmitter

Transmits infrared signals.

## 2 (receiver power) key

Turns on/off (standby) the unit.

## 3 MAIN/ZONE 2 switch

Changes the zone that is controlled by the remote control (p.54).

## 4 SLEEP key

Pressing this key repeatedly will specify the time (120 min, 90 min, 60 min, 30 min, off), in which the unit switches to the standby mode.

## 5 PARTY key

Turns on/off the party mode (p.55).

## 6 SCENE keys

Switch with one touch between multiple settings set using the SCENE function. Also, turn on the unit when it is in standby mode (p.73).

## 7 Input selection keys

Select an input source for playback.

### Note

Presses NET repeatedly to select a desired network source.

## 8 11 14 17 18 19 External device operation keys

Let you perform playback operations when "USB" or "NET" is selected as the input source, or control playback of the HDMI Control-compatible playback device.

### Note

The playback devices must support HDMI Control. Some HDMI Control-compatible devices cannot be used.

## 8 PRESET keys

Select a preset FM/AM radio station (p.62).

Recall Bluetooth, USB, or network content that is registered as a shortcut (p.77).

## 9 OPTION key

Displays the option menu (p.78).

## 10 SETUP key

Displays the setup menu (p.89).

## 11 ENTER/Cursor, RETURN keys

Operates the menu.

## 12 HELP key

In the on-screen menu, the description of a term in the cursor position appears on the TV. This key is enabled when the "?" icon is displayed on the on-screen menu.

## 13 Sound mode keys

Select a sound mode (p.45).

## 14 Playback operation keys

Controls playback of the external device.

## 15 HDMI OUT key

Selects HDMI OUT jacks to be used for video/audio output (p.57).

## 16 PURE DIRECT key

Enables/disables the Pure Direct (p.48).

## 18 VOLUME keys

Adjust the volume.

## 19 MUTE key

Mutes the audio output.

# PREPARATIONS

## 1 Connecting speakers

### Names and functions of speakers

The names and functions of speakers connected to the unit are as follows.

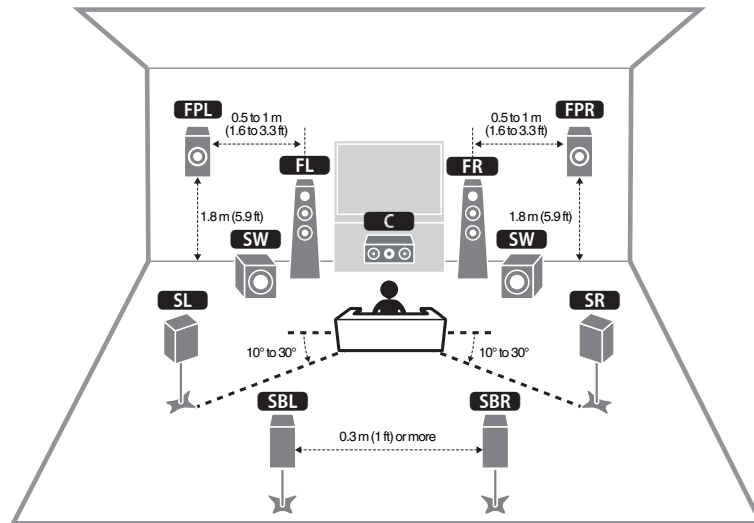

#### Note

Use this diagram as a reference for the ideal speaker layout for the unit. Your speaker layout does not need to match the diagram exactly, since the YPAO function can be used to automatically optimize the speaker settings (such as distances) to suit the actual speaker layout.

Speaker type	Abbr.	Function
Front (L/R)	<b>FL / FR</b>	Produce front channel sounds (stereo sounds).
Center	<b>C</b>	Produces center channel sounds (such as movie dialogue and vocals).
Surround (L/R)	<b>SL / SR</b>	Produce surround channel sounds. Surround speakers also produce surround back channel sounds when no surround back speakers are connected.
Surround back (L/R)	<b>SBL / SBR</b>	Produce surround back channel sounds.
Presence (L/R)	<b>FPL / FPR</b>	Produce CINEMA DSP 3D effect sounds or heights channel sounds of Dolby Atmos and DTS:X contents.
Subwoofer	<b>SW</b>	Produces LFE (low-frequency effect) channel sounds and reinforces the bass parts of other channels.

#### Note

The unit provides three layout patterns for presence speakers. You can choose a layout pattern that suits your listening environment.

- Front Height
- Overhead
- Dolby Enabled SP



## Speaker systems and speakers to be connected

Select the speaker layout for the number of speakers that you are using and place the speakers and subwoofer in your room.

Speaker type	Speaker system (the number of channels)		
	7.1/5.1.2	5.1	2.1
Front (L/R) <b>FL</b> / <b>FR</b>	●	●	●
Center <b>C</b>	●	●	
Surround (L/R) <b>SL</b> / <b>SR</b>	●	○*3	
Surround back (L/R) <b>SBL</b> / <b>SBR</b>	○*1		
Presence (L/R) <b>FPL</b> / <b>FPR</b>	○*2	○*4	
Subwoofer <b>SW</b>	●	●	●

If you have seven speakers, use two of them as surround back speakers (\*1) or presence speakers (\*2).

If you have five speakers, use two of them as surround speakers (\*3) or presence speakers (\*4).

### Note

- “5.1.2-channel” denotes “standard 5.1-channel plus 2 for overhead speaker channels”.
- When using surround back speakers, be sure to connect the surround back left and right speakers. Using only one surround back speaker was discontinued.
- You can also connect up to 2 subwoofers (with built-in amplifier) to the unit.

## Speaker requirements

Speakers and subwoofers to be connected to the unit must meet the following requirements:

- Under its default settings, the unit is configured for 8-ohm speakers. When connecting 6-ohm speakers, set the unit's speaker impedance to “6 Ω MIN”. For details, see the following:
  - “Setting the speaker impedance” (p.18)
- Use a subwoofer with built-in amplifier.

### Note

- Prepare the number of speakers according to your speaker system.
- Be sure to connect the front left and right speakers.

## Setting the speaker impedance

Under its default settings, the unit is configured for 8-ohm speakers. When connecting 6-ohm speakers, set the speaker impedance to "6 Ω MIN".

**1** Before connecting speakers, connect the power cable to an AC wall outlet.

**2** While holding down STRAIGHT on the front panel, press MAIN ZONE .

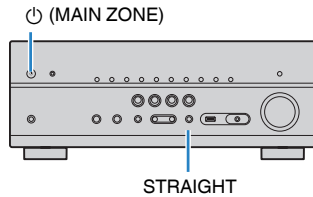

**3** Check that "SP IMP." is displayed on the front display.



**4** Press STRAIGHT to select "6 Ω MIN".

**5** Press MAIN ZONE  to set the unit to standby mode and remove the power cable from the AC wall outlet.

You are now ready to connect the speakers.

## Cable requirements

Use the following types of commercially-available cables to connect speakers to the unit:

Speaker cables (the number of speakers required)



Audio pin cable (for connecting a subwoofer)



## How to connect speakers

### ■ Connecting the speaker

Connect a speaker cable between the negative (-) terminal of the unit and the negative (-) terminal of the speaker, and between the positive (+) terminal of the unit and the positive (+) terminal of the speaker.

#### Notice

When connecting the speaker cables, take notice of the following:

- Prepare speaker cables in a place away from the unit, to avoid accidentally dropping wire strands into the unit's interior which could result in a short circuit or malfunction of the unit.
- Improper connecting of the speaker cables may cause a short circuit and also damage the unit or the speakers.

– Twist the bare wires of the speaker cables firmly together.

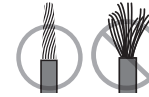

– Do not let the bare wires of the speaker cable touch one another.

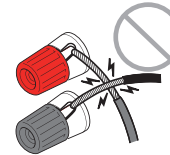

– Do not let the bare wires of the speaker cable come into contact with the unit's metal parts (rear panel and screws).

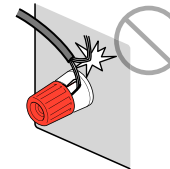

## Note

- Remove the unit's power cable from an AC wall outlet before connecting the speakers.
- Be sure to connect the front left and right speakers.
- Under its default settings, the unit is configured for 8-ohm speakers. When connecting 6-ohm speakers, set the unit's speaker impedance to "6 Ω MIN". For details, see the following:
  - "Setting the speaker impedance" (p.18)

**1** Remove approximately 10 mm (3/8") of insulation from the ends of the speaker cable, and twist the bare wires of the cable firmly together.

**2** Loosen the speaker terminal.

**3** Insert the bare wires of the cable into the gap on the side (upper right or bottom left) of the terminal.

**4** Tighten the terminal.

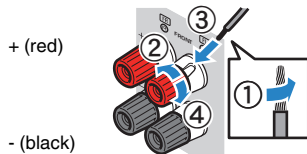

This completes the connection.

## Note

- If "Check SP Wires" appears on the front display when the unit is turned on, turn off the unit, and then confirm that the speaker cables are not short circuited.
- (U.S.A., Canada, China, Taiwan, Brazil, Central and South America and General models only)  
When using a banana plug, tighten the speaker terminal and insert a banana plug into the end of the terminal.

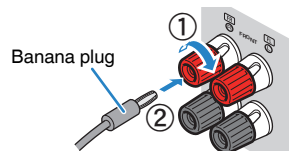

## Connecting the subwoofer

Use an audio pin cable to connect the subwoofer.

## Note

Unplug the power cables of the unit and subwoofer from the AC wall outlets before connecting the subwoofer.

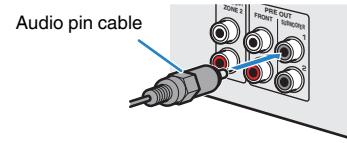

# How to place speakers (speaker systems)

## Using 7.1/5.1.2-channel system

This speaker system brings out the full performance of the unit and allows you to enjoy a highly-natural 3-dimensional sound field with any contents. We recommend this speaker system to have a full effect of Dolby Atmos or DTS:X contents.

### Note

- The surround back speakers and presence speakers do not produce sounds simultaneously. The unit automatically changes the speakers to be used, depending on the input signal and CINEMA DSP 3D.
- When installing the presence speakers on the ceiling above the listening position, or when using Dolby Enabled speakers as the presence speakers, the presence speaker layout settings must be changed. For details, see the following:
  - “Setting the layout of the presence speakers” (p.97)
- You can also connect up to 2 subwoofers (with built-in amplifier) to the unit.

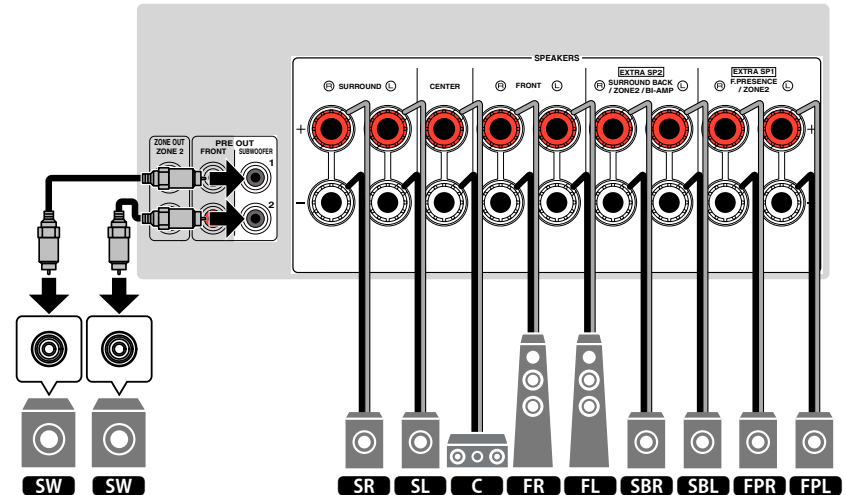
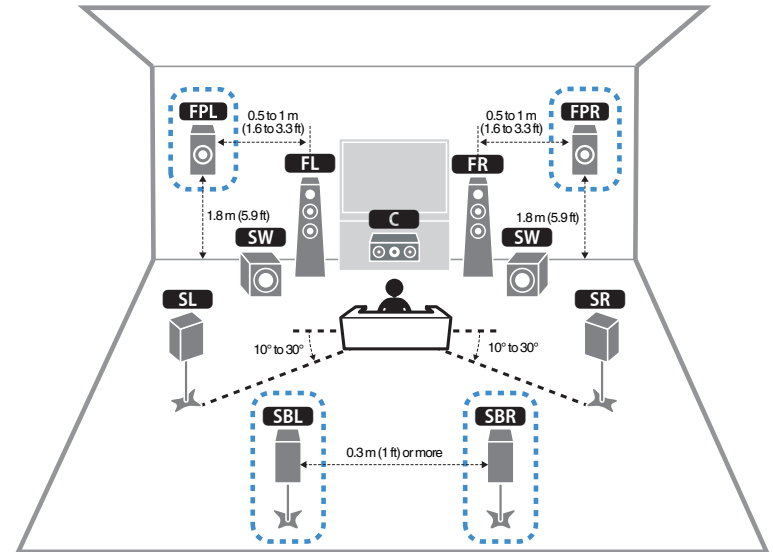

## Using 5.1.2-channel system

To have a full effect of Dolby Atmos or DTS:X contents, we recommend this speaker system. The presence speakers produce a natural 3-dimensional sound field including overhead.

### Note

- When installing the presence speakers on the ceiling above the listening position, or when using Dolby Enabled speakers as the presence speakers, the presence speaker layout settings must be changed. For details, see the following:
  - “Setting the layout of the presence speakers” (p.97)
- You can also connect up to 2 subwoofers (with built-in amplifier) to the unit.

### For Front Height of the presence speakers layout

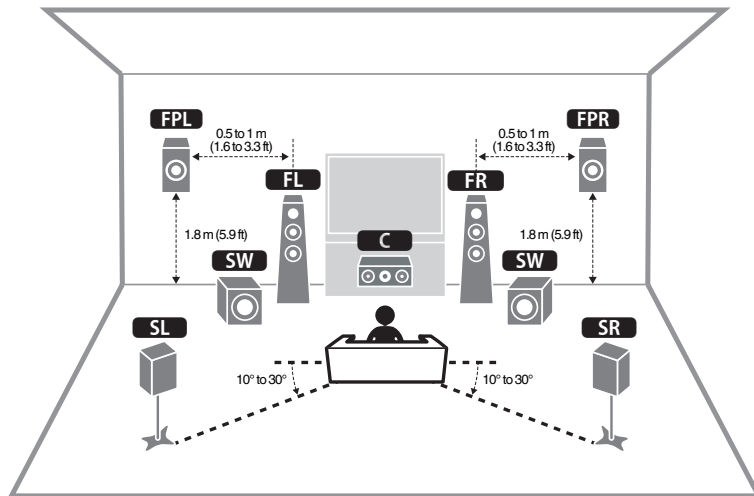

### For Overhead of the presence speakers layout

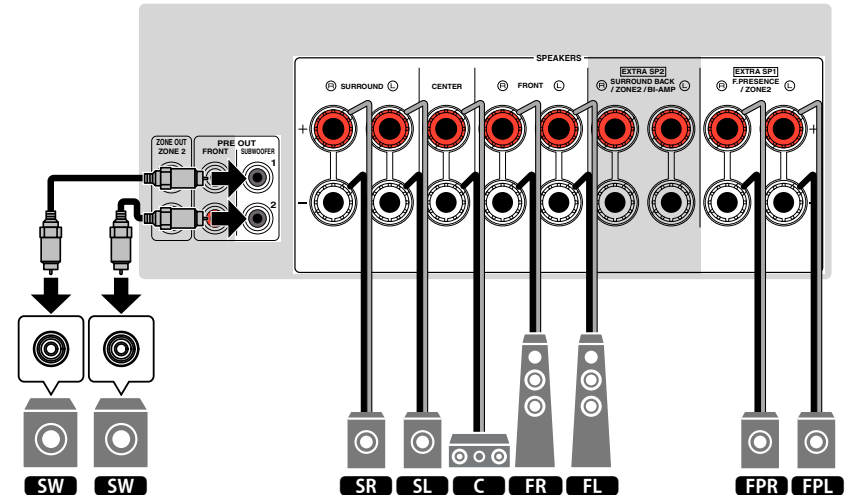
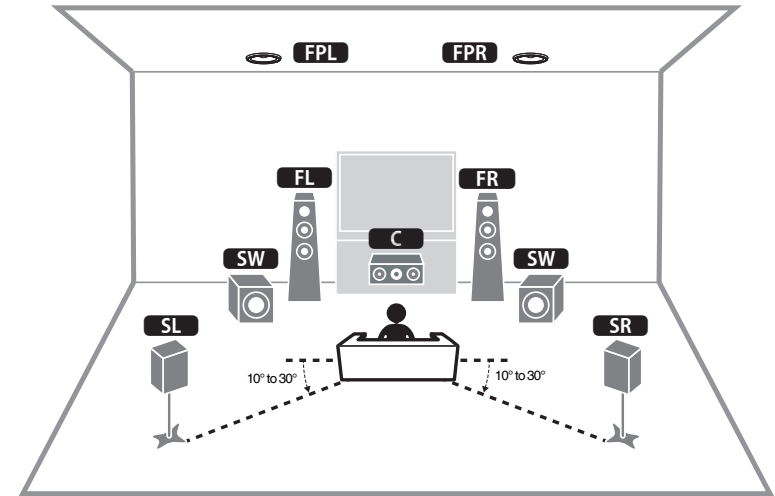

## Using 7.1-channel system

This speaker system allows you to enjoy extended surround sound using the surround back speakers.

### Note

You can also connect up to 2 subwoofers (with built-in amplifier) to the unit.

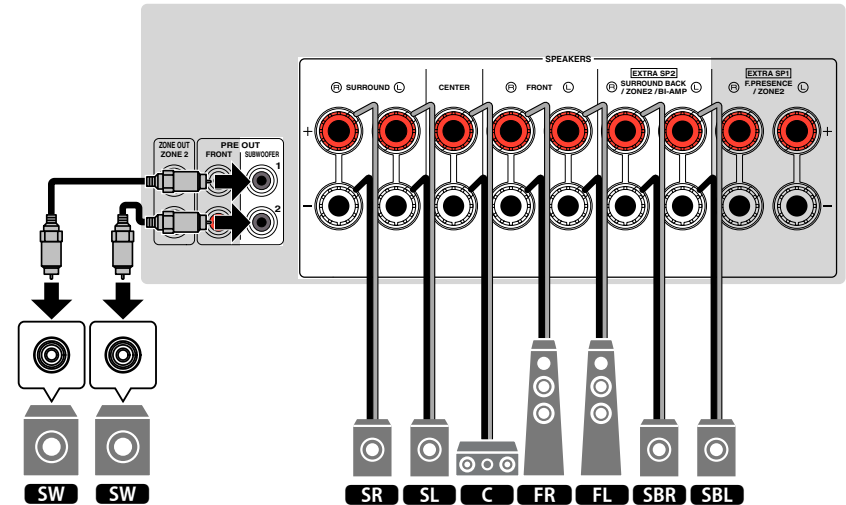
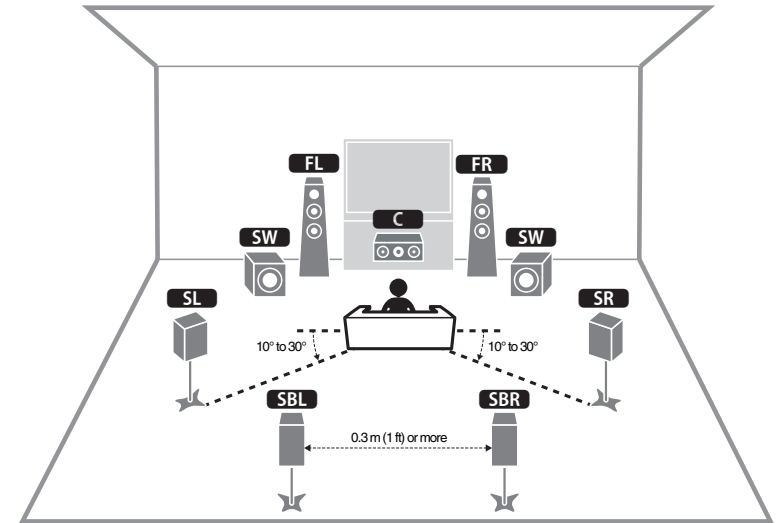

## Using 5.1-channel system

This is a basic speaker layout recommended for enjoying surround sound.

### Note

You can also connect up to 2 subwoofers (with built-in amplifier) to the unit.

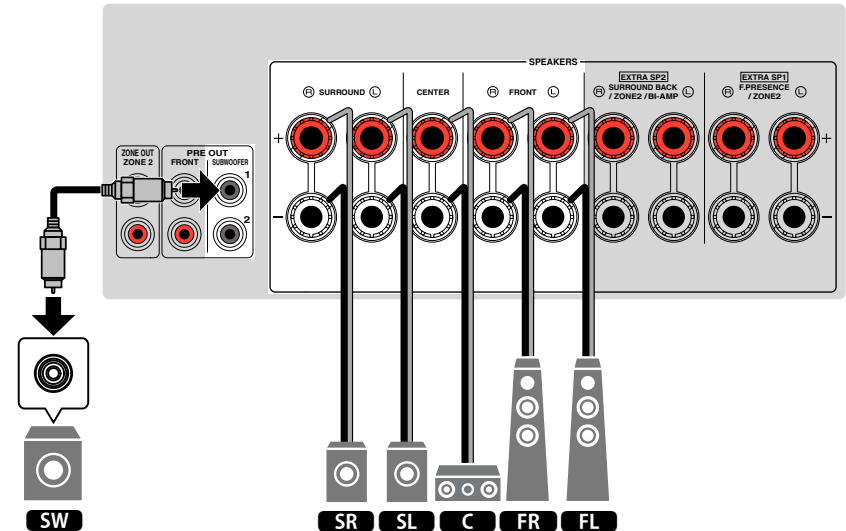
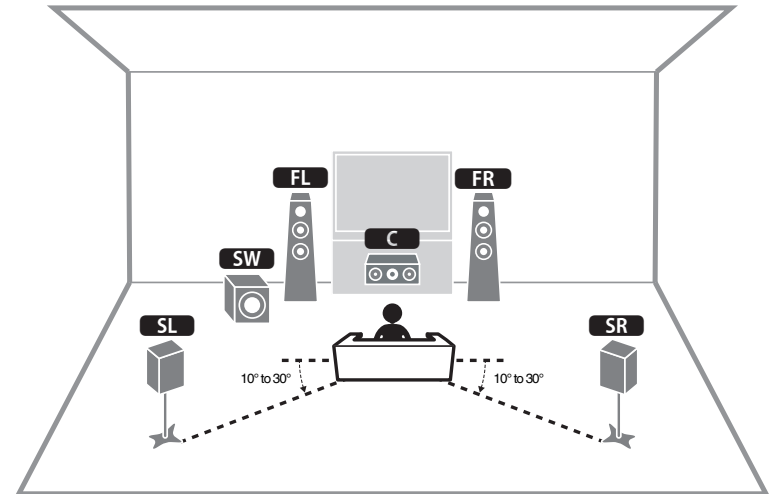

## Using 3.1.2-channel system

We recommend this speaker layout when you cannot place speakers in the back of the room. You can also enjoy Dolby Atmos or DTS:X content with this speaker system.

### Note

- When installing the presence speakers to the ceiling above the listening position or using the Dolby Enabled speakers as the presence speakers, configure your presence speaker layout. For details, see the following:
  - “Setting the layout of the presence speakers” (p.97)
- You can also connect up to 2 subwoofers (with built-in amplifier) to the unit.

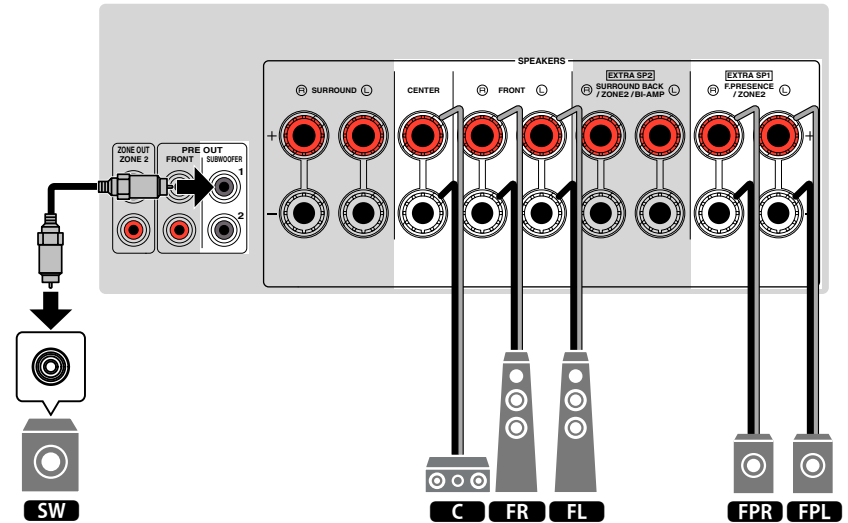
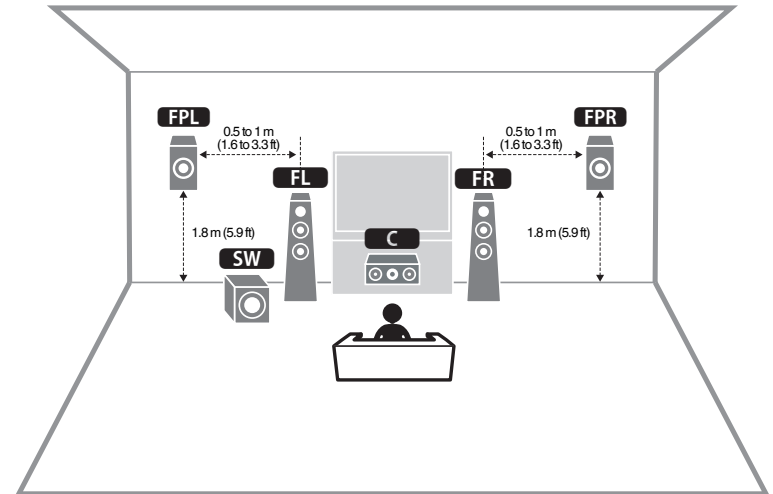



## ■ Using Virtual CINEMA FRONT

This speaker layout is recommended if you cannot place speakers in the back of the room.

### Note

- To use Virtual CINEMA FRONT, the speaker configuration settings must be changed. For details, see the following:
  - “Assigning speaker configuration” (p.37)
  - “Setting the layout of the surround speakers” (p.96)
- You can also connect up to 2 subwoofers (with built-in amplifier) to the unit.

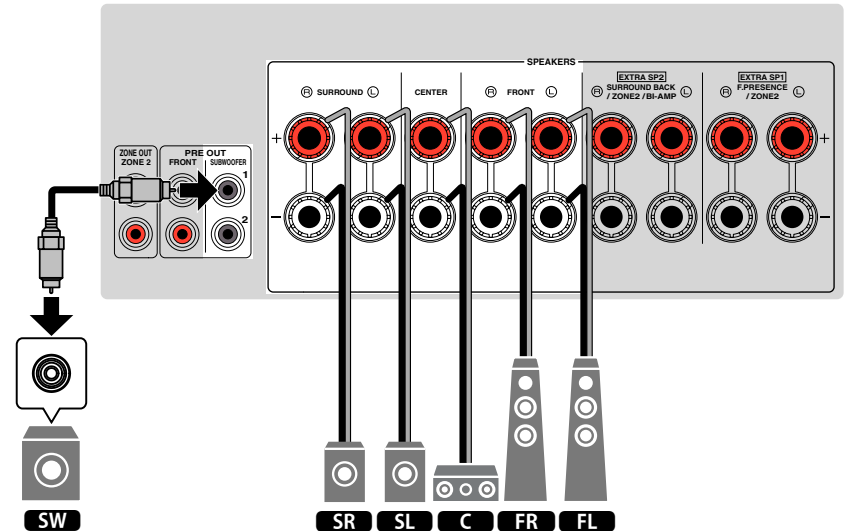
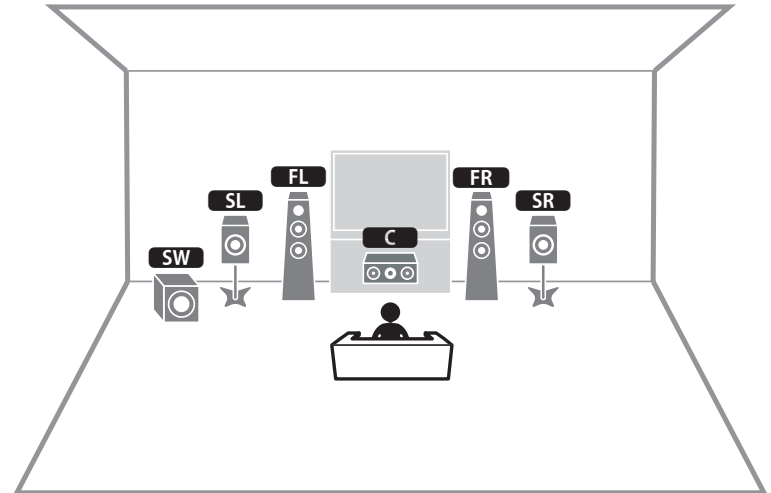

## Advanced speaker systems

### Available configurations for advanced speaker systems using the unit's internal amplifier

In addition to the basic speaker systems, the unit also allows you to apply the following speaker configurations to enhance your system.

- Using the four internal amplifiers for front speakers to have more high-quality sounds (Bi-amp connection)
- Using the excess internal amplifiers for stereo speakers in another room (multi-zone function)

To enjoy following systems, configure the necessary speaker settings in "Power Amp Assign" in the "Setup" menu. For details, see the following:

- "Setting your speaker system" (p.94)

Main zone			Multi-zone	Power Amp Assign
Output channel (max)	Bi-amp	Surround back/ Presence		
7		Surround back	+1 (Zone2)	7.1 + 1Zone
7		Presence	+1 (Zone2)	5.1.2 + 1Zone
5	○			5.1 Bi-Amp

#### Note

For details on connecting speakers in another room (multi-zone function), see the following:

- "Connecting Zone2 speakers using the unit's internal amplifier" (p.51)

### 7.1 + 1Zone

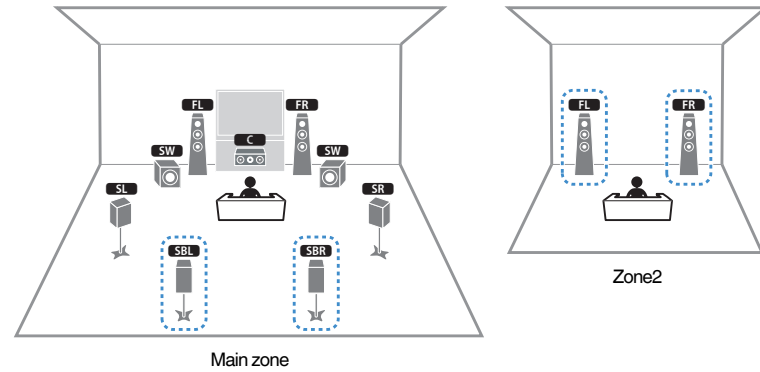

Speaker	Connect to
FL FR	FRONT
C	CENTER
SL SR	SURROUND
SBL SBR	EXTRA SP2
FPL FPR	(not used)
SW	SUBWOOFER 1-2
Zone2 speakers	EXTRA SP1

#### Note

When Zone2 output is enabled, the surround back speakers in the main zone do not output sound. For details on Zone2 output, see the following:

- "Controlling Zone2" (p.54)

## 5.1.2 + 1Zone

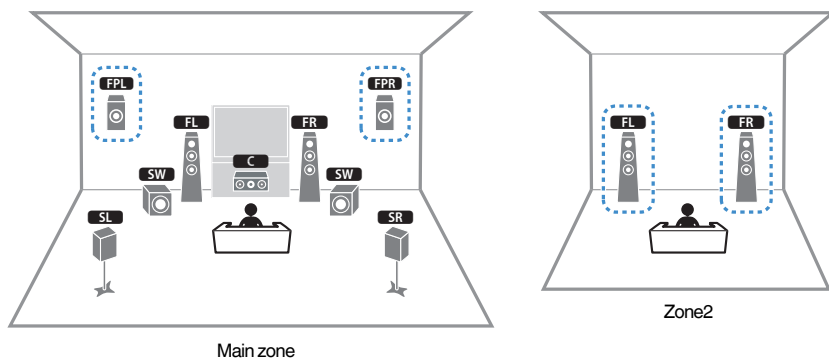

Speaker	Connect to
<b>FL</b> <b>FR</b>	FRONT
<b>C</b>	CENTER
<b>SL</b> <b>SR</b>	SURROUND
<b>SBL</b> <b>SBR</b>	(not used)
<b>FPL</b> <b>FPR</b>	EXTRA SP1
<b>SW</b>	SUBWOOFER 1-2
Zone2 speakers	EXTRA SP2

### Note

When Zone2 output is enabled, the presence speakers in the main zone do not output sound. For details on Zone2 output, see the following:

- “Controlling Zone2” (p.54)

## 5.1 BI-Amp

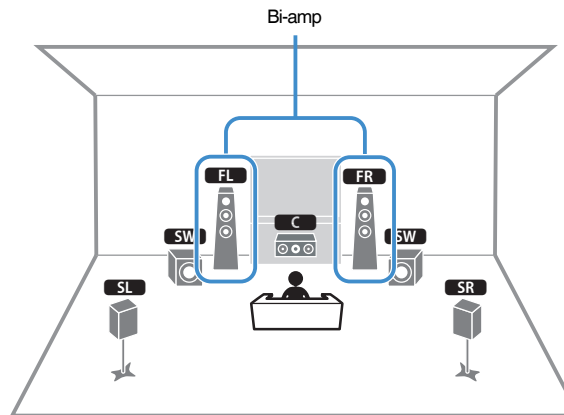

Speaker	Connect to
<b>FL</b> <b>FR</b>	FRONT and EXTRA SP2 (bi-amp connection)
<b>C</b>	CENTER
<b>SL</b> <b>SR</b>	SURROUND
<b>SBL</b> <b>SBR</b>	(not used)
<b>FPL</b> <b>FPR</b>	(not used)
<b>SW</b>	SUBWOOFER 1-2

## ■ Connecting front speakers that support bi-amp connections

You can connect the front speakers that support bi-amp connections.

To enable the bi-amp function, configure the necessary speaker settings. For details, see the following:

- “Assigning speaker configuration” (p.37)
- “Setting your speaker system” (p.94)

### Notice

- Before making bi-amp connections, remove any brackets or cables that connect a woofer with a tweeter. Refer to the instruction manual of the speakers for details. If you are not making bi-amp connections, make sure that the brackets or cables are connected before connecting the speaker cables.

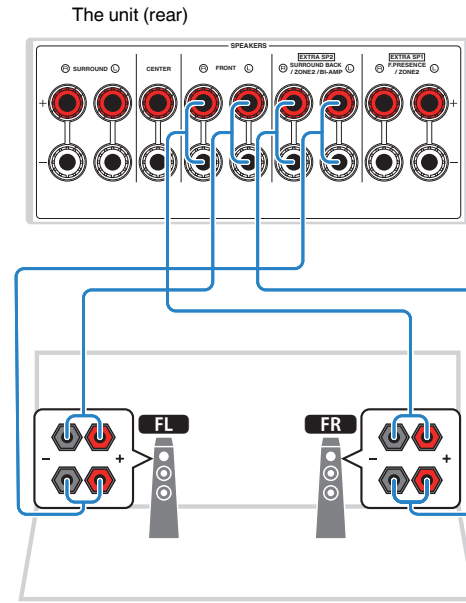

### Note

- The following speakers cannot be connected simultaneously.
  - Surround back speakers
  - Bi-amp speakers
- The FRONT terminals and EXTRA SP2 terminals output the same signals.

## 2 Connecting a TV

### HDMI connection with a TV

Connect a TV to the unit with an HDMI cable. If you connect a TV that supports ARC to the unit, you can output video/audio to the TV or input TV audio to the unit.

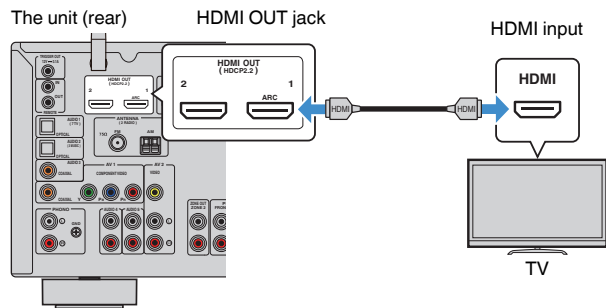

#### About Audio Return Channel (ARC)

- ARC allows audio signals to travel both ways with a single HDMI cable. To use ARC, connect to the TV using an HDMI cable that supports ARC.

#### Note

- If you connect a TV that supports HDMI Control to the unit with an HDMI cable, you can control the unit's power and volume with the TV's remote control.
- To use HDMI Control and ARC, you need to configure the HDMI settings on the unit. For details on the settings, see the following:
  - "HDMI Control and synchronized operations" (p.170)
  - "Audio Return Channel (ARC)" (p.171)
- If your TV does not support Audio Return Channel (ARC), a digital optical cable connection between the TV and the unit is needed.

### HDMI connection with another TV or a projector

The unit has two HDMI output jacks. If you connect another TV or a projector to the unit with an HDMI cable, you can switch the TV (or projector) to be used for watching videos with the remote control. For details, see the following:

- "Selecting an HDMI output jack" (p.57)

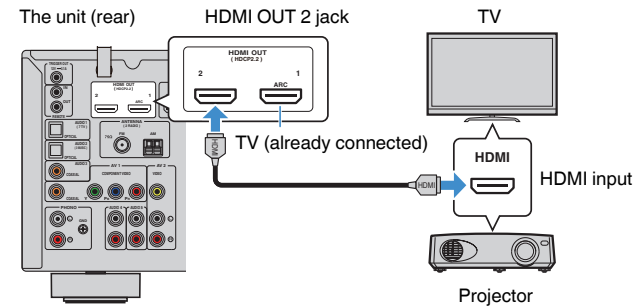

#### Note

HDMI Control is not available on the HDMI OUT 2 jack.

### 3 Connecting playback devices

#### HDMI connection with a video device such as a BD/DVD player

Connect a video device to the unit with an HDMI cable.

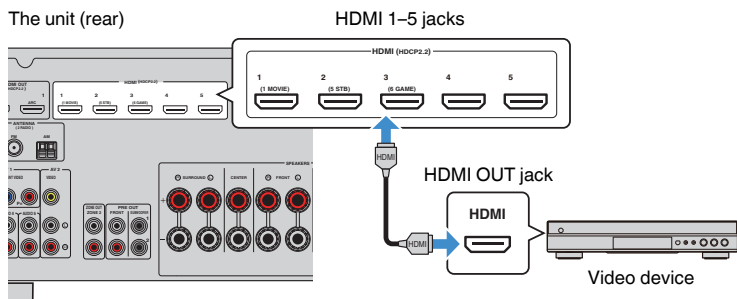

#### Connection other than HDMI with a playback device

##### VIDEO (component video) connection with a video device

Connect a video device to the unit with a component video cable and a digital coaxial cable.

Output jacks on video device		Input jacks on the unit
Video	Audio	
Composite video	Digital coaxial	AV 1 (COMPONENT VIDEO + COAXIAL)

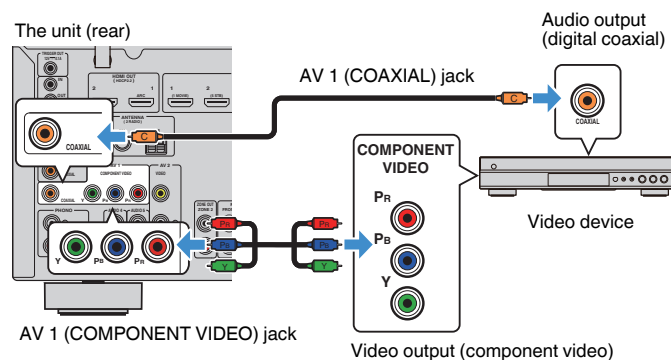

##### Note

- This unit supports only the video signals of 480i and 576i (resolution).
- If the combination of video/audio input jacks available on the unit does not match your video device, change its combination according to the output jacks of your device. For details, see the following:
  - “Combining audio of another input source with video of the current input source” (p.126)

## VIDEO (composite video) connection with a video device

Connect a video device to the unit with a video pin cable and a stereo pin cable.

Output jacks on video device		Input jacks on the unit
Video	Audio	
Composite video	Analog stereo	AV 2 (VIDEO + AUDIO)

The unit (rear)

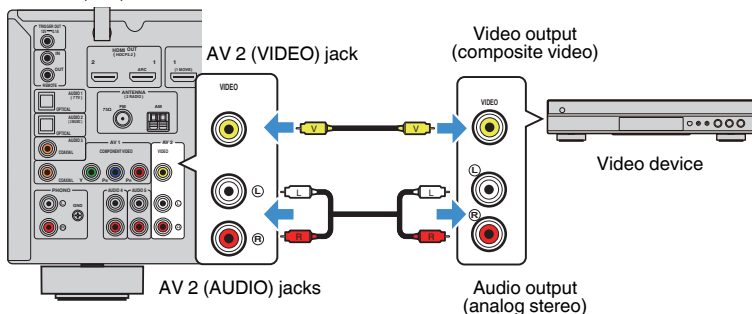

### Note

If the combination of video/audio input jacks available on the unit does not match your video device, change its combination according to the output jacks of your device. For details, see the following:

- “Combining audio of another input source with video of the current input source” (p.126)

## AUDIO connection with an audio device such as a CD player

Connect audio devices such as CD players and MD players to the unit. Depending on the audio output jacks available on your audio device, choose one of the following connections.

Audio output jacks on audio device	Audio input jacks on the unit
Digital optical	AUDIO 1-2 (OPTICAL)
Digital coaxial	AUDIO 3 (COAXIAL) AV 1 (COAXIAL)
Analog stereo	AUDIO 4-5 (AUDIO) AV 2 (AUDIO)
Turntable (PHONO)	PHONO

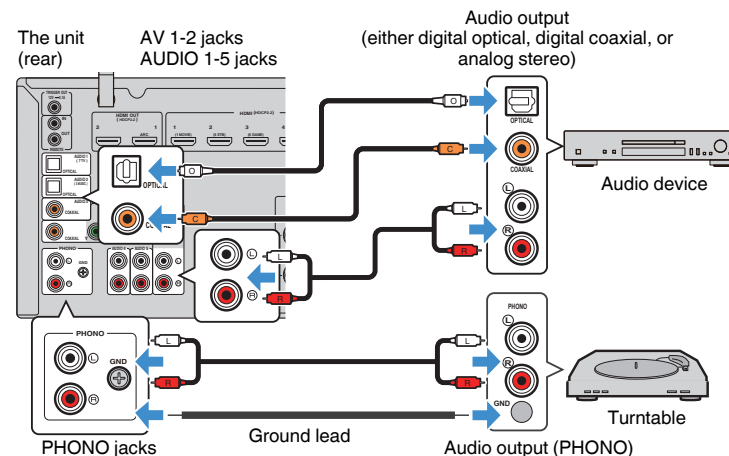

### Note

- The PHONO jack of the unit is compatible with an MM cartridge. To connect a turntable with a low-output MC cartridge, use a boosting transformer.
- Connecting the turntable to the GND terminal of the unit may reduce noise in the signal.
- “AUDIO1” is set as TV audio input at the factory. If you have connected any external device to the AUDIO 1 jacks, use “TV Audio Input” in the “Setup” menu to change the TV audio input assignment. To use the SCENE function, you also need to change the input assignment for SCENE (7). For details, see the following:
  - “Setting the audio jack used for TV audio input” (p.114)
  - “Registering a scene” (p.75)

## Connecting to the jack on the front panel

Use the AUX jack on the front panel to temporarily connect devices such as portable audio players to the unit.



### Caution

- Before making a connection, stop playback on the device and turn down the volume on the unit. The volume may be unexpectedly loud, and this could result in damage to hearing.

### Note

You need to prepare the audio cable that matches the output jacks on your device.

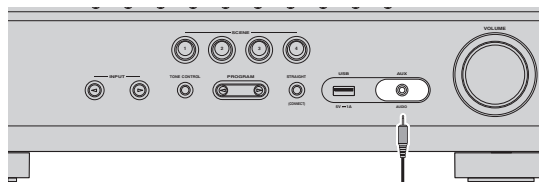

The unit (front)

Portable audio player

If you select "AUX" as the input source by pressing INPUT, the audio played back on the device will be output from the unit.

## 4 Connecting the FM/AM antennas

### Connecting the FM/AM antennas

Connect the supplied FM/AM antennas to the unit.

Fix the end of the FM antenna to a wall, and place the AM antenna on a flat surface.

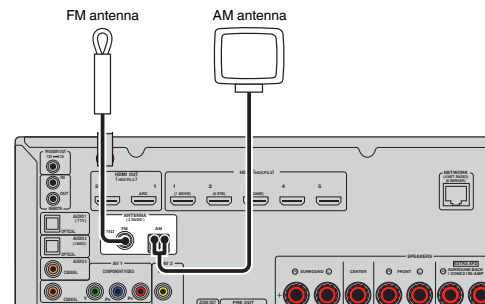

The unit (rear)

### Assembling and connecting the AM antenna

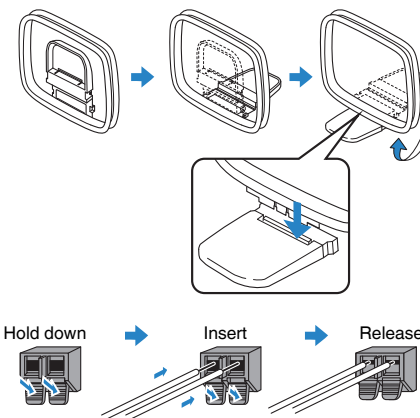

### Note

- Unwind only the length of cable needed from the AM antenna unit.
- The wires of the AM antenna have no polarity.



## 5 Preparing for connecting to a network

### Preparing for connecting to a network

The unit supports wired and wireless connections. Select a connection method according to your network environment.

If you are using a router that supports DHCP in the wired connection, you do not need to configure any network settings for the unit.

#### Note

You need to configure the network settings if your router does not support DHCP or if you want to configure the network parameters manually. For details, see the following:

- “Setting the network parameters manually” (p.117)

To connect the unit to a wireless network, select one of the following methods to configure the wireless network settings.

#### ● Method using the MusicCast setting

When adding the unit to the MusicCast network, you can also configure the unit's wireless network settings at once. If you use MusicCast CONTROLLER, we recommend the wireless connection to MusicCast network. For details, see the following:

- “Adding the unit to the MusicCast network” (p.44)

#### ● Other methods

For details, see the following:

- “Selecting a wireless network connection method” (p.153)

### Connecting a network cable (wired connection)

Connect the unit to your router with a commercially-available STP network cable (CAT-5 or higher straight cable).

You can enjoy Internet radio or music files stored on media servers, such as PCs and Network Attached Storage (NAS), on the unit.

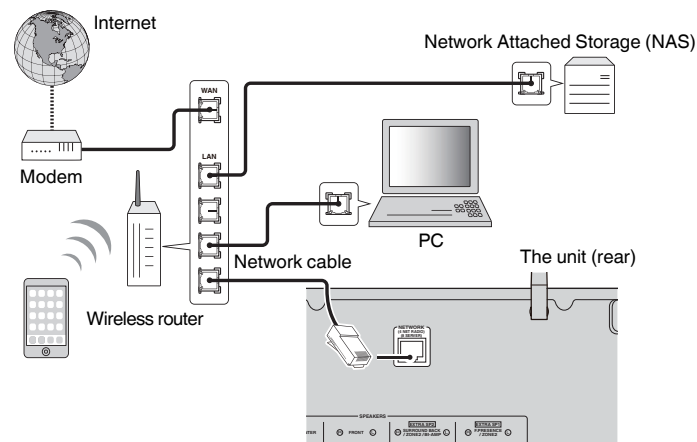

#### Note

- If you are using a router that supports DHCP, you do not need to configure any network settings for the unit, as the network parameters (such as the IP address) will be assigned automatically to it. You only need to configure the network settings if your router does not support DHCP or if you want to configure the network parameters manually. For details, see the following:
  - “Setting the network parameters manually” (p.117)
- You can check whether the network parameters (such as IP address) are properly assigned to the unit. For details, see the following:
  - “Checking the network information on the unit” (p.116)

## Preparing wireless antennas (wireless connection)

Stand the wireless antennas upright for connecting to the wireless network or a Bluetooth device wirelessly.

For information on how to connect the unit to a wireless network, see the following:

- “Preparing for connecting to a network” (p.33)

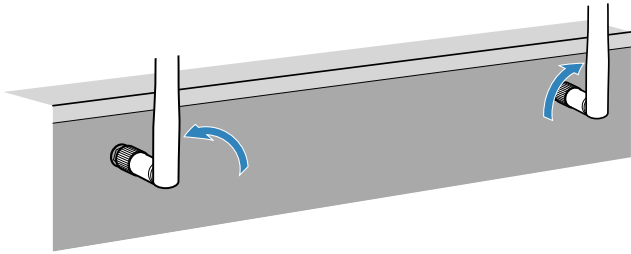

### Notice

- Do not apply excessive force on the wireless antenna. Doing so may damage the antenna.

## 6 Connecting other devices

### Connecting an external power amplifier

When connecting an external power amplifier (pre-main amplifier) to enhance speaker output, connect the input jacks of the power amplifier to the PRE OUT jacks of the unit. The same channel signals are output from the PRE OUT jacks as from their corresponding SPEAKERS terminals.



### Caution

- To prevent the generation of loud noises or abnormal sounds, make sure the followings before making connections.
  - Unplug the power cable of the unit and turn off the external power amplifier before connecting them.
  - When using the PRE OUT jacks, do not connect speakers to the corresponding SPEAKERS terminals.
  - When using an external amplifier that does not have the volume control bypass, do not connect other devices (except the unit) to the amplifier.

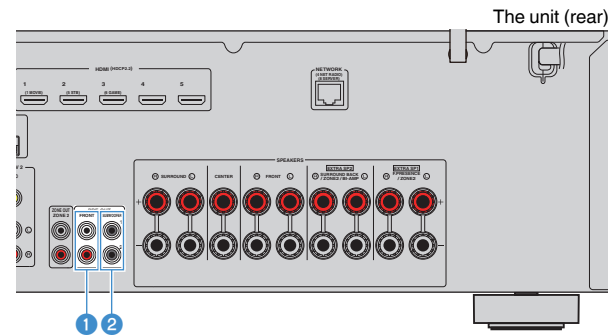

- 1 **FRONT jacks**  
Output front channel sounds.

- 2 **SUBWOOFER 1-2 jacks**  
For connecting a subwoofer with built-in amplifier.

## Connecting a device compatible with the trigger function

The trigger function can control an external device in conjunction with operating the unit (such as powering on/off and input selection). If you have a Yamaha subwoofer that supports a system connection or a device with a trigger input jack, you can use the trigger function by connecting the external device to the TRIGGER OUT jack with a monaural mini-jack cable.

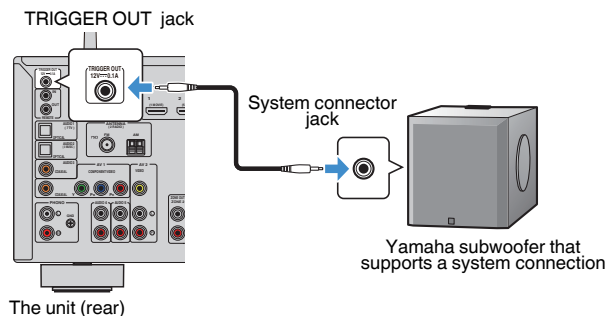

### Note

You can configure the trigger function settings. For details, see the following:

- "Specifying the zone with which the TRIGGER OUT jack functions are synchronized" (p.131)

## 7 Plugging in the power cable

### Plugging in the power cable



#### Warning

(Taiwan, Brazil and Central and South America models only)

Make sure you set VOLTAGE SELECTOR of the unit BEFORE plugging the power cable into an AC wall outlet. Improper setting of VOLTAGE SELECTOR may cause damage to the unit and create a potential fire hazard.

#### Before plugging in the power cable

Set the switch position of VOLTAGE SELECTOR according to your local voltage. Voltages are AC 110–120/220–240 V, 50/60 Hz.

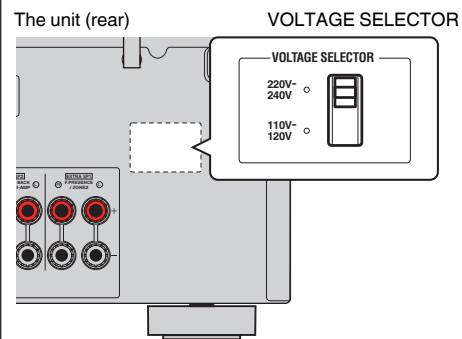

After all the connections are complete, plug in the power cable.

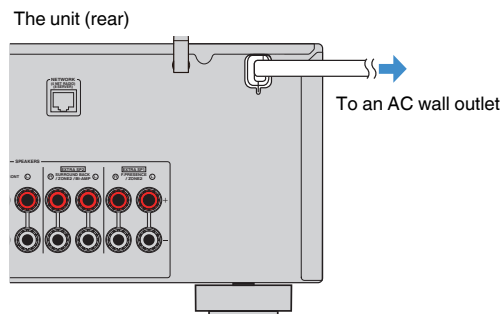

## 8 Selecting the on-screen menu language

### Selecting the on-screen menu language

Select the desired on-screen menu language.

- 1 Press **⏻** (receiver power) to turn on the unit.
- 2 Turn on the TV and switch the TV input to display video from the unit (HDMI OUT jack).

#### Note

When you turn on the unit for the first time, a message regarding the network setup appears. You can switch the language on this message screen.

- 3 Press **SETUP**.
- 4 Use the cursor keys to select “System” and press **ENTER**.
- 5 Use the cursor keys to select “Language” and press **ENTER**.

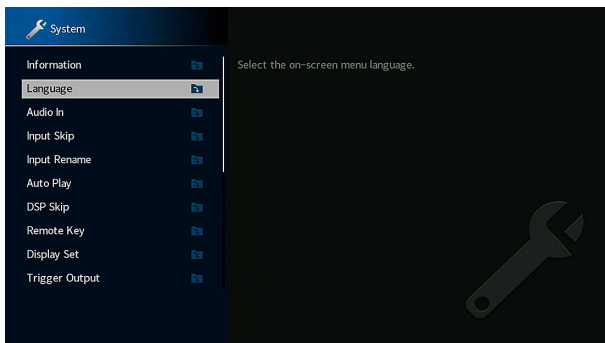

- 6 Use the cursor keys to select the desired language.

- 7 To exit from the menu, press **SETUP**.

This completes the necessary settings.

#### Note

The information on the front display is provided in English only.

## 9 Configuring the necessary speaker settings

### Assigning speaker configuration

If you use any of the following speaker configurations, perform the following procedure to configure the corresponding speaker settings manually before performing YPAO.

- Using the bi-amp connection (playing back more high-quality sounds with bi-amp connections)
- Using the Zone2 speakers
- Using the surround speakers for front 5.1-channel system (Virtual CINEMA FRONT)
- Using the presence speakers for Dolby Atmos or DTS:X playback

#### Note

For details on the speaker configurations, see the following:

- “Connecting front speakers that support bi-amp connections” (p.28)
- “Playing back music in multiple rooms” (p.51)
- “Using Virtual CINEMA FRONT” (p.25)
- “Presence speaker layout” (p.162)

- 1 Press  (receiver power) to turn on the unit.**
- 2 Turn on the TV and switch the TV input to display video from the unit (HDMI OUT jack).**

#### Note

If you turn on the unit for the first time, the message regarding the network setup appears. For now, press RETURN and proceed to Step 3.

- 3 Press SETUP.**
- 4 Use the cursor keys to select “Speaker” and press ENTER.**

### 5 Configure the corresponding speaker settings.

- Using bi-amp connections or Zone2 speakers, select your speaker system in “Power Amp Assign”. For details, see the following:
  - “Setting your speaker system” (p.94)
- Using the surround speakers for front 5.1-channel system (Virtual CINEMA FRONT), select your surround speaker layout in “Configuration”. For details, see the following:
  - “Setting the layout of the surround speakers” (p.96)
- Using the presence speakers for Dolby Atmos or DTS:X playback, select your presence speaker layout in “Configuration”. For details, see the following:
  - “Setting the layout of the presence speakers” (p.97)

### 6 To exit from the menu, press SETUP.

This completes the speaker settings.

## Optimizing the speaker settings automatically (YPAO)

The Yamaha Parametric room Acoustic Optimizer (YPAO) function detects speaker connections, measures the distances from them to your listening position(s), and then automatically optimizes the speaker settings, such as volume balance and acoustic parameters, to suit your room.

### Note

- Use YPAO after connecting a TV and speakers to the unit.
- Configure the corresponding speaker settings manually before performing YPAO. For details on the settings, see the following:
  - “Assigning speaker configuration” (p.37)
- During the measuring process, test tones are output at high volume, and you cannot adjust the volume.
- During the measuring process, keep the room as quiet as possible and do not stand between the speakers and the YPAO microphone for accurate measurement.
- Do not connect headphones.

- 1 Press  (receiver power) to turn on the unit.
- 2 Turn on the TV and switch the TV input to display video from the unit (HDMI OUT jack).
- 3 Turn on the subwoofer and set the volume to half. If the crossover frequency is adjustable, set it to maximum.

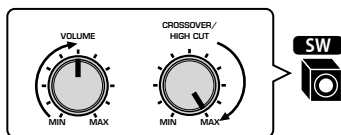

- 4 Place the YPAO microphone at your listening position and connect it to the YPAO MIC jack on the front panel.

Place the YPAO microphone at your listening position (same height as your ears). We recommend the use of a tripod as a microphone stand. You can use the tripod screws to stabilize the microphone.

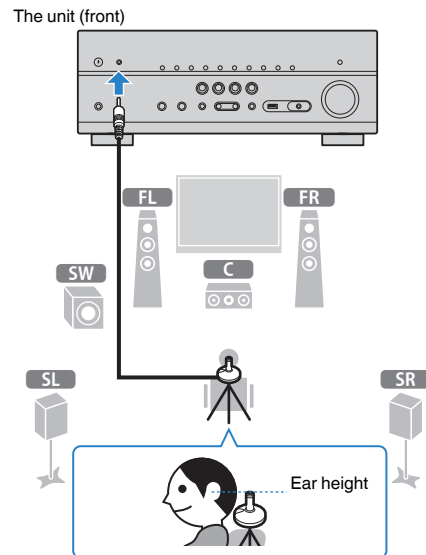

The following screen appears on the TV.

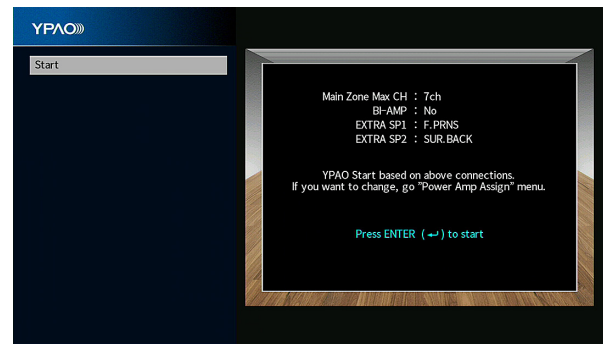

### Note

- To cancel the operation, disconnect the YPAO microphone before starting the measurement.
- To configure the power amplifier assignment setting, press RETURN and select “Speaker” in the “Setup” menu. For details, see the following:
  - “Setting your speaker system” (p.94)

## 5 To start the measurement, press ENTER.

The measurement will start in 10 seconds. Press ENTER to start the measurement immediately.

The following screen appears on the TV when the measurement finishes.

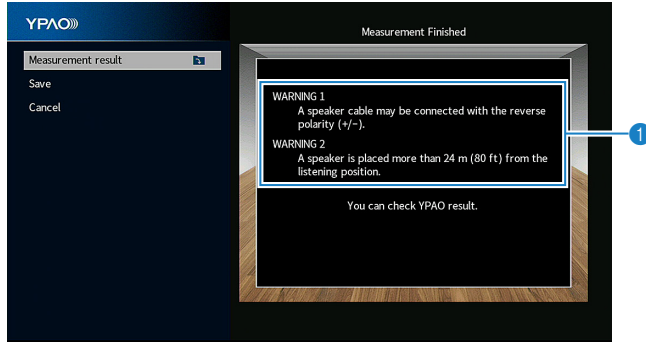

### 1 Warning message (if available)

#### Note

- To stop the measurement temporarily, press RETURN.
- If any error message or warning message appears, see the following:
  - “Error messages from YPAO” (p.42)
  - “Warning messages from YPAO” (p.43)

## 6 Confirm the results displayed on the screen.

#### Note

To check the measurement results specifically, select “Measurement result” and press ENTER. For details, see the following:

- “Checking the YPAO measurement results” (p.40)

## 7 Use the cursor keys to select “Save” and press ENTER.

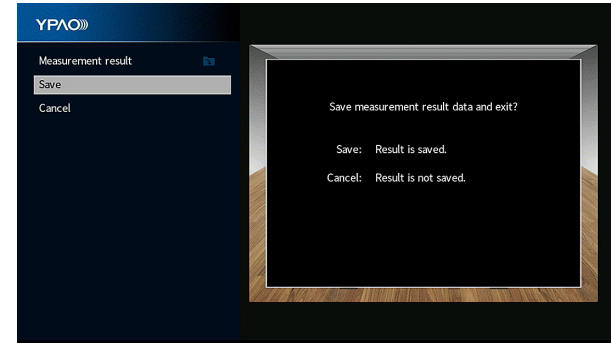

The adjusted speaker settings are applied.

#### Note

To finish the measurement without applying the result, select “Cancel”.

## 8 Disconnect the YPAO microphone from the unit.

This completes optimization of the speaker settings.

#### Notice

- The YPAO microphone is sensitive to heat, so should not be placed anywhere where it could be exposed to direct sunlight or high temperatures (such as on top of AV equipment).

#### Note

“YPAO Volume” in the “Option” menu is automatically enabled after the YPAO measurement. Then, the high- and low-frequency levels are automatically adjusted according to the volume so that you can enjoy natural sounds even at low volume. For details on “YPAO Volume”, see the following:

- “Adjusting the high- and low-frequency levels automatically according to the volume” (p.80)

## Checking the YPAO measurement results

You can check the YPAO measurement results.

### 1 After the measurement, use the cursor keys to select “Measurement result” and press ENTER.

#### Note

You can also check the previous measurement results in the “Setup” menu. For details, see the following:

- “Reloading the previous YPAO adjustments” (p.100)

The following screen appears.

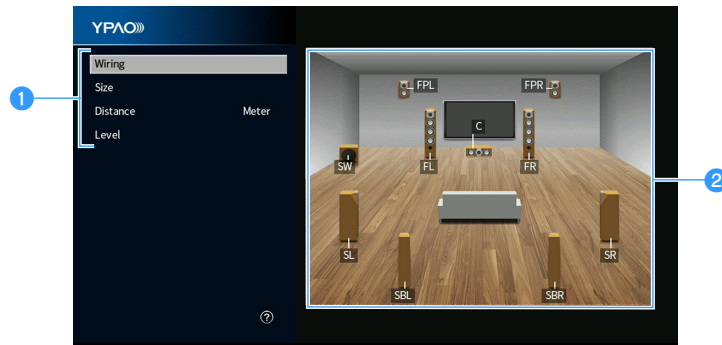

- 1 Measurement result items
- 2 Measurement result details

### 2 Use the cursor keys to select an item.

<b>Wiring</b>	Polarity of each speaker Reverse: The speaker cable may be connected with the reverse polarity (+/-).
<b>Size</b>	Size of each speaker (cross-over frequency of the subwoofer) Large: The speaker can reproduce low-frequency signals effectively. Small: The speaker cannot reproduce low-frequency signals effectively.
<b>Distance</b>	Distance from the listening position to each speaker
<b>Level</b>	Output level adjustment for each speaker

### 3 To finish checking the results and return to the previous screen, press RETURN.



## Reloading the previous YPAO adjustments

When the speaker settings you have configured manually are not suitable, follow the procedure below to discard the manual settings and reload the previous YPAO adjustments.

- 1 Press SETUP.**
- 2 Use the cursor keys to select “Speaker” and press ENTER.**
- 3 Use the cursor keys to select “YPAO Result” and press ENTER.**
- 4 Use the cursor keys to select “Setup Reload” and press ENTER.**

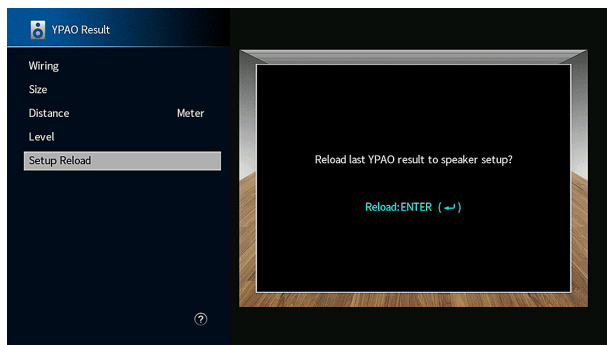

## 5 Press SETUP.

This completes the settings.

### Note

For details, see the following:

- “Reloading the previous YPAO adjustments” (p.100)

## Error messages from YPAO

If any error message is displayed during the measurement, resolve the problem and perform YPAO again.

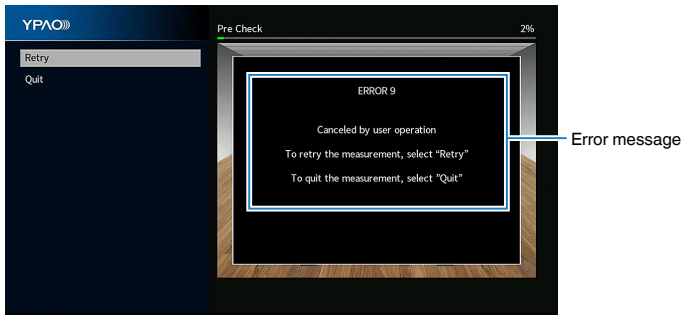

TV screen

Error message	Remedy
<b>ERROR 1</b> <b>Front speakers are not detected.</b>	
<b>ERROR 2</b> <b>One of the surround speakers cannot be detected.</b>	
<b>ERROR 3</b> <b>One of the front presence speakers cannot be detected.</b>	Exit YPAO, turn off the unit, and then check the speaker connections.
<b>ERROR 4</b> <b>One of the surround back speakers cannot be detected.</b>	
<b>ERROR 5</b> <b>The noise is too loud.</b>	Keep the room quiet and retry YPAO. If you select "Proceed", YPAO takes the measurement again and ignores any noise detected.
<b>ERROR 6</b> <b>Surround back speakers are connected, but no surround speakers are connected.</b>	Surround speakers need to be connected in order to use surround back speakers. Exit YPAO, turn off the unit, and then reconnect the speakers.
<b>ERROR 7</b> <b>The YPAO microphone has been removed.</b>	Connect the YPAO microphone to the YPAO MIC jack firmly and retry YPAO.
<b>ERROR 8</b> <b>The YPAO microphone cannot detect test tones.</b>	Connect the YPAO microphone to the YPAO MIC jack firmly and retry YPAO. If this error occurs repeatedly, contact the nearest authorized Yamaha dealer or service center.
<b>ERROR 9</b> <b>Canceled by user operation</b>	Retry or exit YPAO as necessary. To exit the YPAO, use the cursor keys to select "Quit" and press ENTER.
<b>ERROR 10</b> <b>An internal error has occurred.</b>	Exit YPAO, and turn off and on the unit. If this error occurs repeatedly, contact the nearest authorized Yamaha dealer or service center.

### Note

- To exit the YPAO measurement for resolving the problem, use the cursor keys to select "Quit" and press ENTER.
- For the ERROR 5 and ERROR 9 messages only, you can proceed with the current YPAO measurement. Use the cursor keys to select "Proceed" and press ENTER.
- To retry the YPAO measurement from beginning, use the cursor keys to select "Retry" and press ENTER.

## Warning messages from YPAO

If a warning message is displayed after the measurement, you can still apply the measurement results by following on-screen instructions.

However, we recommend you perform YPAO again in order to use the unit with the optimal speaker settings.

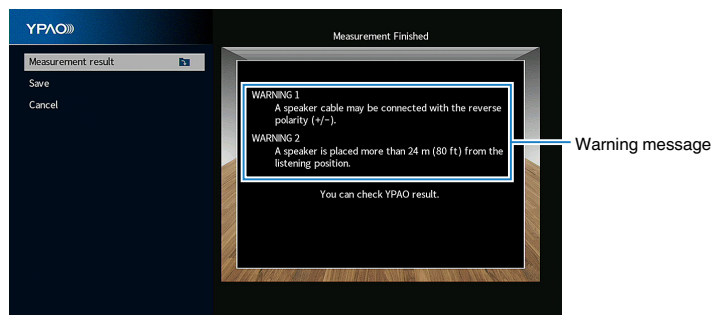

TV screen

Warning message	Remedy
<b>WARNING 1</b> <b>A speaker cable may be connected with the reverse polarity (+/-).</b>	Use the cursor keys to select "Measurement result" and press ENTER, and then select "Wiring" in "Measurement result". Check the cable connections (+/-) of the speaker identified by "Reverse".  <b>If the speaker is connected incorrectly:</b> Turn off the unit, reconnect the speaker cable.  <b>If the speaker is connected correctly:</b> Depending on the type of speakers or room environment, this message may appear even if the speakers are connected correctly. In this case, you can ignore the message.
<b>WARNING 2</b> <b>A speaker is placed more than 24 m (80 ft) from the listening position.</b>	Use the cursor keys to select "Measurement result" and press ENTER, and then select "Distance" in "Measurement result". Check the speaker identified by ">24.00m (>80.0ft)". Exit YPAO, turn off the unit, and place the problem speaker within 24 m (80 ft) of the listening position.
<b>WARNING 3</b> <b>There are significant volume differences between the speakers.</b>	Use the cursor keys to select "Measurement result" and press ENTER, and then select "Level" in "Measurement result". Check the speaker identified by ">+10.0dB" or "<-10.0dB". Then, check the usage environment and cable connections (+/-) of each speaker, and the volume of the subwoofer. If there is any problem, exit YPAO, turn off the unit, and then reconnect speaker cable or correct the speaker positions. We recommend using the same speakers or speakers with specifications that are as similar as possible.

## 10 Setting MusicCast

### What is MusicCast

MusicCast is a brand new wireless musical solution from Yamaha, allowing you to share music among all of your rooms with a variety of devices. You can enjoy music from your smartphone, PC, NAS drive and music streaming service anywhere in your house with one easy-to-use application. For more details and a lineup of MusicCast compatible products, refer to the following site:

<http://www.yamaha.com/musiccast/>

- Seamlessly control all MusicCast compatible devices with the dedicated application “MusicCast CONTROLLER”.
- Link a MusicCast compatible device to another device in a different room and play them back simultaneously.
- Play back music from music streaming services. (The compatible music streaming services may differ depending on your region and product).
- Configure wireless network settings of MusicCast compatible devices.

### Using MusicCast CONTROLLER

To use the network features on the MusicCast compatible device, you need the dedicated application “MusicCast CONTROLLER” for the operation. Search for the free application “MusicCast CONTROLLER” on the App Store or Google Play and install it to your device.

### Adding the unit to the MusicCast network

Perform the following procedure to add the unit to the MusicCast network. You can also configure the unit’s wireless network settings at once.

#### Note

The SSID and security key for your network will be needed.

- 1 Tap the “MusicCast CONTROLLER” application icon on your mobile device and tap “Setup”.

#### Note

If you have already connected other MusicCast compatible devices to the network, tap “Settings” and then “Add New Device”.

- 2 Operate the “MusicCast CONTROLLER” application following the on screen instructions, then hold down **CONNECT** on the front panel of the unit for 5 seconds.

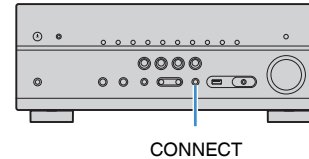

- 3 Operate the “MusicCast CONTROLLER” application following the onscreen instructions to set up the network.

This completes adding the unit to the MusicCast network and the network settings.

#### Note

- AirPlay and DSD audio cannot be delivered.
- When the Pure Direct is enabled, input sources other than the network sources, Bluetooth and USB cannot be delivered.
- If you configure the unit’s wireless settings with this method, the wireless LAN indicator of the front display lights up when the unit is connecting to a network (even if a wired connection is used).
- You can interlock the power of MusicCast devices with the power of the unit (the MusicCast master). For details on the settings, see the following:
  - “Setting the power interlock from the unit to MusicCast compatible devices” (p.119)

# ENJOYING SOUND

## Enjoying sound field effects

### Select your favorite sound mode

The unit is equipped with a variety of sound programs and surround decoders that allow you to enjoy playback sources with your favorite sound mode (such as sound field effect or stereo playback).

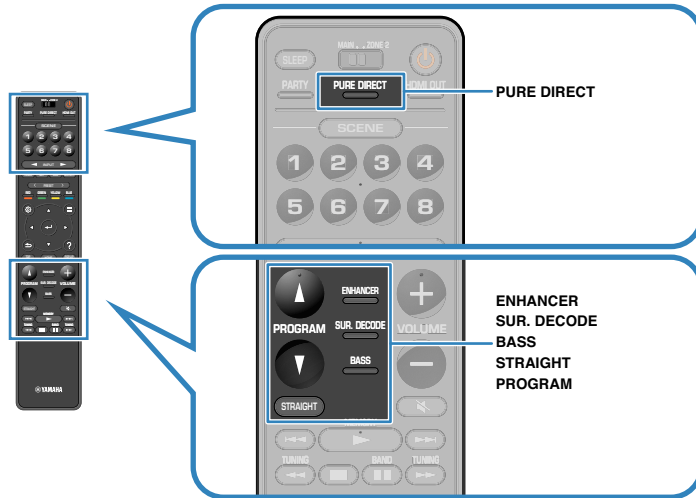

#### Note

- The sound mode can be applied separately to each input source.
- You can check which speakers are currently outputting sound by looking at the speaker indicators on the front display.

### Enjoying 3D sound fields (CINEMA DSP 3D)

#### CINEMA DSP 3D

The unit is equipped with a variety of sound programs that utilize Yamaha's original DSP technology (CINEMA DSP 3D). It allows you to easily create sound fields like actual movie theaters or concert halls in your room and enjoy natural three-dimensional sound fields.

Sound program category

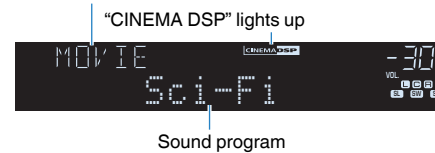

#### Note

- You can adjust the sound field effect level. For details, see the following:
  - “Adjusting the sound field effect level” (p.104)
- The sound mode can be applied separately to each input source.
- We recommend using presence speakers in order to experience the full effect of the stereoscopic sound fields. However, even when no presence speakers are connected, the unit creates Virtual Presence Speaker (VPS) using the front, center, and surround speakers to produce stereoscopic sound fields.
- If a multichannel source (6.1/7.1-channel) is input when no surround back speakers are connected, the unit creates Virtual Surround Back Speaker (VSBS) using the surround speakers to add a sense of depth to the rear sound field.
- When VPS or VSBS is working, “VIRTUAL” lights up in the front display.

## Enjoying sound field effects optimized for the type of content

---

The unit is equipped with a variety of sound programs.

You can enjoy playback sources with your favorite sound mode, such as with a sound field effect added or with stereo playback.

- We recommend a sound program in the “MOVIE” category to enjoy video content.
- We recommend a sound program in the “MUSIC” category to enjoy music content.

For details on the sound programs, see the following:

- “Selecting sound programs” (p.103)

### Note

You can select a sound program by pressing PROGRAM.

## Enjoying sound field effects without surround speakers (Virtual CINEMA DSP)

---

If you select one of the sound programs (except 2ch Stereo and 7ch Stereo) when no surround speakers are connected, the unit automatically creates the surround sound field using the front speakers.

### Note

When Virtual CINEMA DSP is working, “VIRTUAL” lights up on the front display.

## Enjoying surround sound with 5 speakers placed in front (Virtual CINEMA FRONT)

---

You can enjoy the surround sound even when the surround speakers are placed in front.

When “Layout” in “Surround” in the “Setup” menu is set to “Front”, the unit creates the virtual surround speakers in the rear side to allow you to enjoy multichannel surround sound with the 5 speakers placed in the front.

### Note

- For details on the settings, see the following:
  - “Setting the layout of the surround speakers” (p.96)
- When Virtual CINEMA FRONT is working, “VIRTUAL” lights up on the front display.

## Enjoying surround sound with headphones (SILENT CINEMA)

---

### SILENT™ CINEMA

You can enjoy surround or sound field effects, like a multichannel speaker system, with stereo headphones by connecting the headphones to the PHONES jack and selecting a sound program or a surround decoder.

## Enjoying unprocessed playback

### Enjoying original sound (straight decode)

When STRAIGHT is pressed and the straight decode mode is enabled, the unit produces stereo sound from the front speakers for 2-channel sources such as CDs, and produces unprocessed multichannel sounds for multichannel sources.



Each time you press the key, the straight decode mode is enabled or disabled.

#### Note

- When surround back speakers are used, the unit produces 7.1-channel sound for 5.1-channel sources.
- If "Layout" in "Surround" in the "Setup" menu is set to "Front", Virtual CINEMA FRONT works when multichannel source is played back. For details, see the following:
  - "Setting the layout of the surround speakers" (p.96)
  - "Enjoying surround sound with 5 speakers placed in front (Virtual CINEMA FRONT)" (p.46)

### Enjoying multichannel playback without sound field effects (surround decoder)

Press SUR. DECODE to select a surround decoder. The surround decoder enables multichannel playback from 2-channel sources without sound field effects.

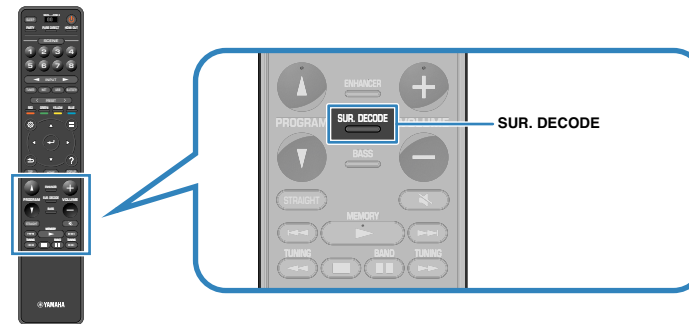

"SUR. DECODE" appears



Each time you press the key, the surround decoder changes.

## Note

- You can also change the surround decoder in “Surround Decoder” in the “Setup” menu. For details, see the following:
  - “Selecting the surround decoder used in the program” (p.107)
- For details on each decoder, see the following:
  - “Glossary of audio decoding format” (p.164)
- You can adjust the surround decoder parameters in “Surround Decoder” in the “Setup” menu. For details, see the following:
  - “Adjusting the center localization (broadening effect) of the front sound field” (p.108)
  - “Setting the use of Center Spread” (p.108)
- The selected surround decoder may not work for some input sources.
- We recommend Dolby Surround while network streaming is Dolby contents.
- When the Dolby Surround decoder or the Neural:X decoder is selected, virtual surround processing (such as Virtual CINEMA FRONT) does not work. For details, see the following:
  - “Enjoying sound field effects without surround speakers (Virtual CINEMA DSP)” (p.46)
  - “Enjoying surround sound with 5 speakers placed in front (Virtual CINEMA FRONT)” (p.46)

## Enjoying pure high fidelity sound (Pure Direct)

When PURE DIRECT is pressed and the direct playback mode is enabled, the unit plays back the selected source with the least circuitry. It allows you to enjoy Hi-Fi sound quality.



Each time you press the key, the direct playback mode is enabled or disabled.

## Note

When the Pure Direct is enabled, the following functions are not available.

- Selecting sound programs
- Using the multi-zone function
- Adjusting the tone control
- Operating the on-screen “Setup” and “Option” menus
- Viewing information on the front display (when not in operation)



## Enjoying enhanced bass sound

### Enhancing the bass (Extra Bass)

Press BASS to enable Extra Bass and enjoy enhanced bass sound, regardless of the size of the front speakers and the presence or absence of a subwoofer.

Each time you press the key, Extra Bass is enabled or disabled.

#### Note

You can also use “Extra Bass” in the “Option” menu to enable/disable Extra Bass. For details, see the following:

- “Setting the use of Extra Bass” (p.83)

## Enjoying enhanced compressed music

### Playing back digitally compressed formats with enriched sound (Compressed Music Enhancer)

#### compressed music ENHANCER

Press ENHANCER to enable Compressed Music Enhancer and add depth and breadth to the sound, allowing you to enjoy a dynamic sound close to the original sound before it was compressed. This function can be used along with any other sound modes.

“ENHANCER” lights up



Each time you press the key, Compressed Music Enhancer is enabled or disabled.

#### Note

- Compressed Music Enhancer does not work on the following audio sources.
  - Signals whose sampling frequency is over 48 kHz
  - DSD audio
- You can also use “Enhancer” in the “Option” menu to enable/disable Compressed Music Enhancer. For details, see the following:
  - “Setting Compressed Music Enhancer” (p.82)

### Enjoying Dolby Atmos® and DTS:X™

Playing back Dolby Atmos or DTS:X content creates realistic sound that comes from every direction, including overhead. To receive the full effect of Dolby Atmos or DTS:X content, we recommend a speaker system with presence speakers.

#### Note

For details on the speaker system with the presence speakers, see the following:

- “Using 7.1/5.1.2-channel system” (p.20)
- “Using 5.1.2-channel system” (p.21)

#### About Dolby Atmos®

- Dolby Atmos contents are decoded as Dolby TrueHD or Dolby Digital Plus in the following situations. (Dolby Atmos PCM format is always decoded as Dolby Atmos.)
  - Neither surround back nor presence speakers are used.
  - Headphones are used (2-channel playback).
- When the Dolby Atmos decoder is selected, virtual surround processing (such as Virtual CINEMA FRONT) does not work. For details, see the following:
  - “Enjoying sound field effects without surround speakers (Virtual CINEMA DSP)” (p.46)
  - “Enjoying surround sound with 5 speakers placed in front (Virtual CINEMA FRONT)” (p.46)

#### About DTS:X™

- When DTS:X contents are played back, you can adjust the volume of dialogue sounds in “DTS Dialogue Control” in the “Option” menu. For details, see the following:
  - “Adjusting the volume of dialogue sound during DTS:X™ playback” (p.81)
- When the DTS:X decoder is selected, virtual surround processing (such as Virtual CINEMA FRONT) does not work. For details, see the following:
  - “Enjoying sound field effects without surround speakers (Virtual CINEMA DSP)” (p.46)
  - “Enjoying surround sound with 5 speakers placed in front (Virtual CINEMA FRONT)” (p.46)

## Enjoying music in multiple rooms

### Playing back music in multiple rooms

The multi-zone function allows you to play back different input sources in the room where the unit is installed (Main zone) and in another room (Zone2).

For example, while you are watching TV in the living room (Main zone), another person can listen to radio in the study room (Zone2).

Two methods for connecting the device that will be used in Zone2 to the unit are available; using the unit's internal amplifier or using an external amplifier. When using an external amplifier, you can select 7.1/5.1.2-channel speaker system in Main zone.

- "Connecting Zone2 speakers using the unit's internal amplifier" (p.51)
- "Connecting Zone2 speakers using an external amplifier" (p.53)

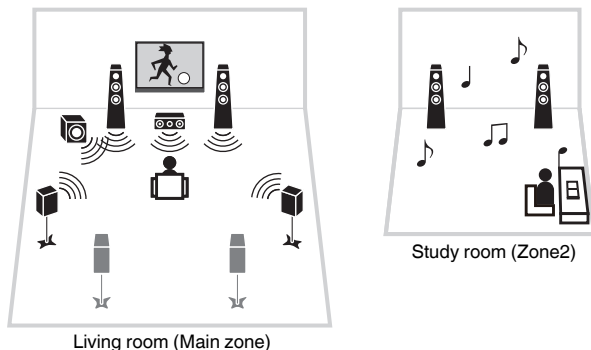

#### Note

- Digital and analog audio sources (including FM/AM radio), Bluetooth, USB, and network sources can be output to Zone2. To listen to the playback of an external device in Zone2, you need to connect the device to the AUDIO jacks (AV 1-2, AUDIO 1-5 or PHONO jacks) of the unit.
- "Main Zone Sync" allows you to play back the same audio output in Main zone as Zone2. When "Main Zone Sync" is selected as the Zone2 input, the Zone2 input automatically switches in conjunction with the input source selected in the main zone.
- The party mode allows you to play back the same audio output in Main zone as Zone2, whatever the input audio signal type. Multichannel sources are mixed down to 2 channels and output to the Zone2. For details on the party mode, see the following:
  - "Enjoying the same source in multiple rooms (party mode)" (p.55)

### Connecting Zone2 speakers

#### Connecting Zone2 speakers using the unit's internal amplifier

Connect the speakers placed in Zone2 to the unit with a speaker cable.

#### Notice

- Unplug the unit's power cable from an AC wall outlet before connecting the speakers.

To enable the multi-zone function, configure the necessary speaker settings. For details, see the following:

- "Available configurations for advanced speaker systems using the unit's internal amplifier" (p.26)
- "Assigning speaker configuration" (p.37)
- "Setting your speaker system" (p.94)

#### Note

You can also connect Zone2 speakers using an external amplifier. For details, see the following:

- "Connecting Zone2 speakers using an external amplifier" (p.53)

## ■ When using surround back speakers in the main zone

Connect Zone2 speakers to the EXTRA SP1 terminals. To utilize the EXTRA SP terminals for Zone2 speakers, set "Power Amp Assign" in the "Setup" menu to "7.1 + 1Zone". For details, see the following:

- "Setting your speaker system" (p.94)

The unit (rear)

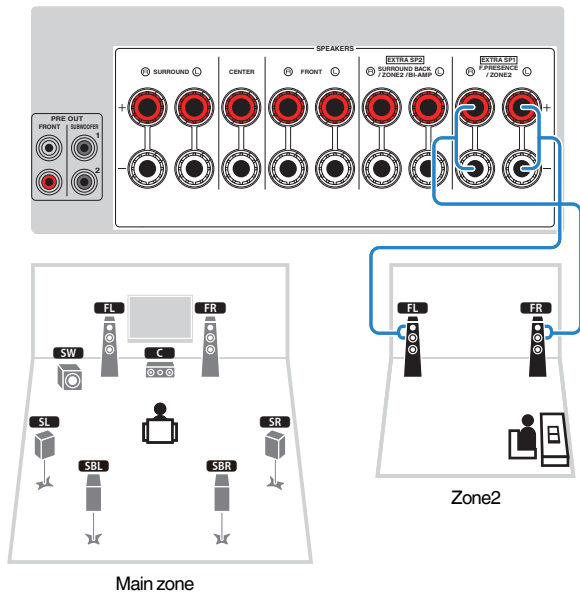

## ■ When using presence speakers in the main zone

Connect Zone2 speakers to the EXTRA SP2 terminals. To utilize the EXTRA SP terminals for Zone2 speakers, set "Power Amp Assign" in the "Setup" menu to "5.1.2 + 1Zone". For details, see the following:

- "Setting your speaker system" (p.94)

The unit (rear)

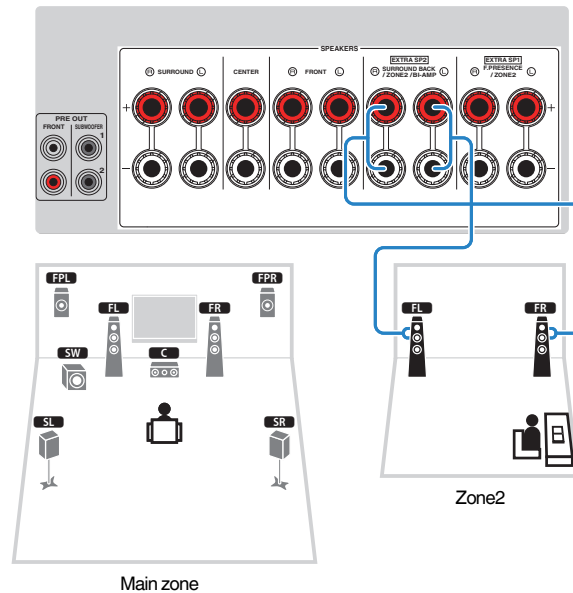

## Connecting Zone2 speakers using an external amplifier

Connect the external amplifier placed in Zone2 to the unit with a stereo pin cable.

### Notice

- Unplug the unit's power cable from the AC wall outlet before connecting an external amplifier.

### Note

You can connect the speakers placed in Zone2 to the unit with speaker cables. For details, see the following:

- "Connecting Zone2 speakers using the unit's internal amplifier" (p.51)

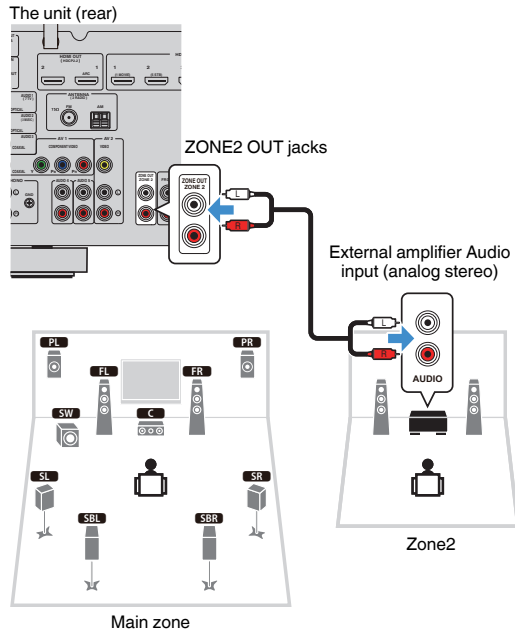

### Note

You can adjust the volume for Zone2 output with the unit. When using an external amplifier with volume control, set "Volume" in the "Setup" menu to "Fixed". For details, see the following:

- "Setting the use of volume adjustments for Zone2 output" (p.121)

## Operating the unit from Zone2 (remote connection)

You can operate the unit or external devices from Zone2 using the remote control supplied with each device if you connect an infrared signal receiver/emitter to the unit's REMOTE IN/OUT jacks.

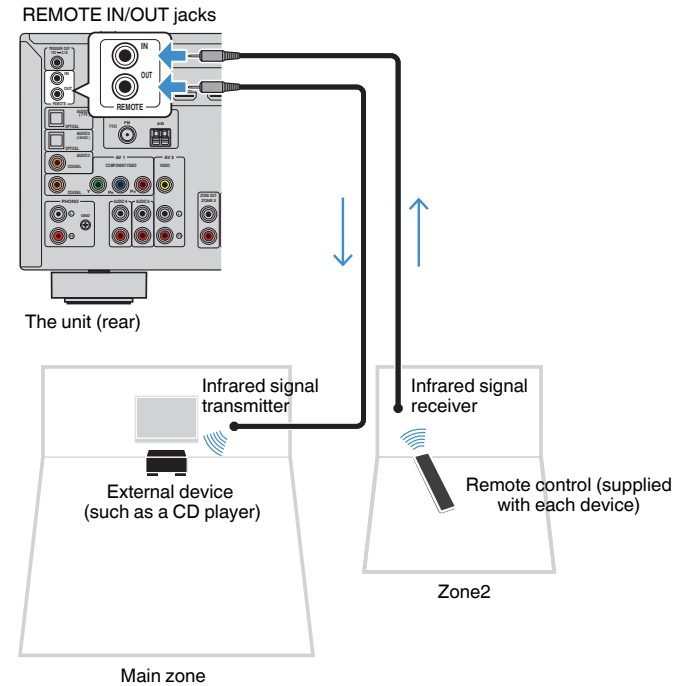

An infrared signal transmitter is not required if you are using Yamaha products that support remote connections, as the unit does. You can transmit remote control signals by connecting the REMOTE IN/OUT jacks with monaural mini-jack cables and an infrared signal receiver.

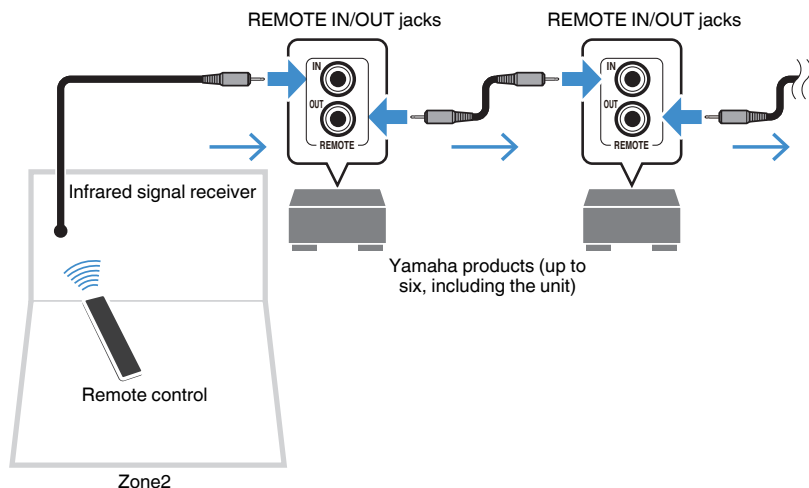

## Controlling Zone2

Basic procedure for playing back music in Zone2 is as follows.

**1** Set MAIN/ZONE 2 to “ZONE 2”.

**2** Press  (receiver power).

Each time you press the key, Zone2 output is enabled or disabled. When Zone2 output is enabled, “ZONE2” lights up in the front display.

**3** Use the input selection keys to select an input source.

### Note

- Presses NET repeatedly to select a desired network source.
- You cannot select Bluetooth, USB and network sources exclusively for each zone. For example, if you select “SERVER” for Zone2 when “USB” is selected for the main zone, the input source for the main zone also switches to “SERVER”.

**4** Start playback on the external device or select a radio station.

### Note

- The on-screen operations are not available for Zone2. Use the front display to control Zone2.
- AirPlay is available in Zone2 only when AirPlay playback is ongoing in the main zone.
- Press SCENE to select the input source and settings with just one touch using the SCENE function. For details on the SCENE function, see the following:
  - “Selecting the input source and favorite settings with one touch (SCENE)” (p.73)
- To set the sleep timer (120 min, 90 min, 60 min, 30 min, off), press SLEEP repeatedly. The Zone2 output will be disabled after a specified period of time.
- To adjust the Zone2 volume, press VOLUME or MUTE (when using the unit’s internal amplifier).
- To enable the Compressed Music Enhancer function, press ENHANCER.
- The Zone2 input automatically switches in conjunction with the input source selected in the main zone when “Main Zone Sync” is selected as the Zone2 input.
- To play back DSD audio in Zone2, select “Main Zone Sync” as the Zone2 input or use the party mode.
- Depending on the “Remote Key” setting, the PROGRAM Key may be also available in Zone2.



### Caution

- To avoid unexpected noise, never play back DTS-CDs in Zone2.

## Enjoying the same source in multiple rooms (party mode)

---

Press PARTY, and then the party mode allows you to play back in Zone2 the same music that is being played back in the main zone. During the party mode, stereo playback is automatically selected for all zones. Utilize this function when you want to use main zone music as background music for a house party.

Each time you press the key, the party mode is turned on or off.

### Note

If the party mode does not work on Zone2, set "Party Mode Set" in the "Setup" menu to "Enable". For details, see the following:

- "Setting the use of switching to the party mode on Zone2" (p.124)

# PLAYBACK

## Basic playback procedure

### Basic procedure for playing back video and music

Basic procedure for playing back video and music is as follows.

- 1 Turn on the external devices (such as a TV or BD/DVD player) connected to the unit.
- 2 Use the input selection keys to select an input source.

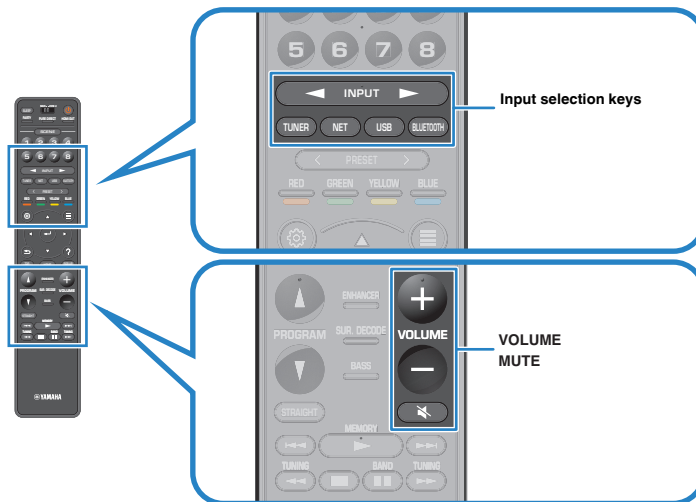

- 3 Start playback on the external device or select a radio station.
- 4 Press **VOLUME** to adjust the volume.

#### Note

- To mute the audio output, press MUTE. Press MUTE again to unmute.
- Refer to the instruction manual for the external device.



## Selecting an HDMI output jack

Press HDMI OUT to select the HDMI OUT jacks for video/audio output.

Each time you press the key, the HDMI OUT jack to be used for signal output changes.



<b>HDMI OUT 1+2</b>	Outputs the same signal at both the HDMI OUT 1 and HDMI OUT 2 jacks.
<b>HDMI OUT 1</b>	Output the signals at the HDMI OUT 1 jack.
<b>HDMI OUT 2</b>	Output the signals at the HDMI OUT 2 jack.
<b>HDMI OUT Off</b>	Does not output the signals at the HDMI OUT jacks.

### Note

- You can also select an HDMI output jack by selecting a scene. For details, see the following:
  - “Selecting the input source and favorite settings with one touch (SCENE)” (p.73)
- When “HDMI OUT 1+2” is selected, the unit outputs video signals at the highest resolution supported by both TVs (or projectors) connected to the unit. (For example, if you have connected a 1080p TV to the HDMI OUT 1 jack and a 720p TV to the HDMI OUT 2 jack, the unit outputs 720p video signals.)

## Switching information on the front display

Press INFO on the front panel to select between the various display items on the front display, as shown in the following table.



Item

About 3 seconds after a display item is selected, its corresponding information appears.



Information

Currently input source	Displayed item
<b>HDMI</b>	
<b>AV</b>	
<b>AUX</b>	Input (input source name), DSP Program (sound mode name), Audio Decoder (decoder name*)
<b>AUDIO</b>	
<b>PHONO</b>	
<b>TUNER</b>	Frequency (frequency), DSP Program (sound mode name), Audio Decoder (decoder name*) (U.K., Europe, Russia and Middle East models only) Radio Data System data is also available when the unit is tuned into a Radio Data System broadcasting station. For details, see the following: <ul style="list-style-type: none"> <li>• “Displaying the Radio Data System information” (p.65)</li> </ul>
<b>Bluetooth</b>	Song (song title), Artist (artist name), Album (album name), DSP Program (sound mode name), Audio Decoder (decoder name*)
<b>USB</b>	
<b>SERVER</b>	Song (song title), Artist (artist name), Album (album name), DSP Program (sound mode name), Audio Decoder (decoder name*), IP Address, Ethernet MAC, Wi-Fi MAC
<b>AirPlay</b>	
<b>NET RADIO</b>	Song (song title), Album (album name), Station (station name), DSP Program (sound mode name), Audio Decoder (decoder name*), IP Address, Ethernet MAC, Wi-Fi MAC
<b>MusicCast Link</b>	DSP Program (sound mode name), Audio Decoder (decoder name*), IP Address, Ethernet MAC, Wi-Fi MAC

\* The name of the audio decoder currently activated is displayed. If no audio decoder is activated, “Decoder Off” appears.

### Note

Available items vary depending on the selected input source. The displayed item can also be applied separately to each input group which is shown in the table and divided by ruled lines.

## Item names and functions of the playback screen

The item names and functions of the playback screen, available when your TV is connected to the unit via HDMI, are as follows.

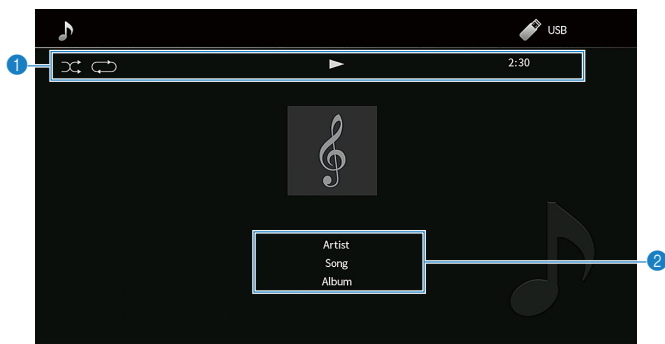

### 1 Status indicators

Display the current shuffle/repeat settings, playback status (such as play/pause) and elapsed time.

### 2 Playback information

Displays the artist name, song title and album name.

Use the following remote control keys to control playback.

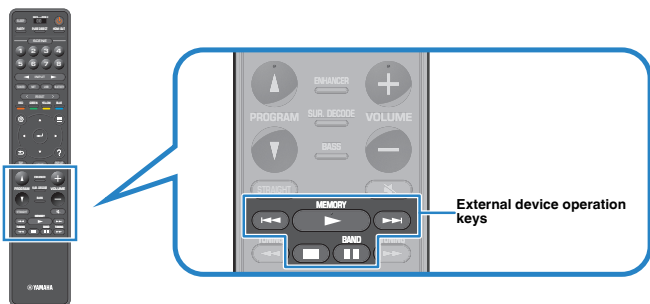

External device operation keys	Function
	Resumes playback from pause.
	Stops playback.
	Stops playback temporarily.
	—Skips forward/backward.

### Note

- Displayed items vary depending on the content of playback.
- Press RETURN to display the browse screen.
- When “Video Out” in the “Option” menu is set to except “Off”, you can close the playback screen by pressing the left cursor key. To display the playback screen again, press any cursor key. For details on “Video Out”, see the following:
  - “Selecting a video source to be output with the selected audio source” (p.83)

## Item names and functions of the browse screen

The item names and functions of the browse screen, available when your TV is connected to the unit via HDMI, are as follows. The browse screen appears when the next input source is selected.

- USB
- SERVER
- NET RADIO

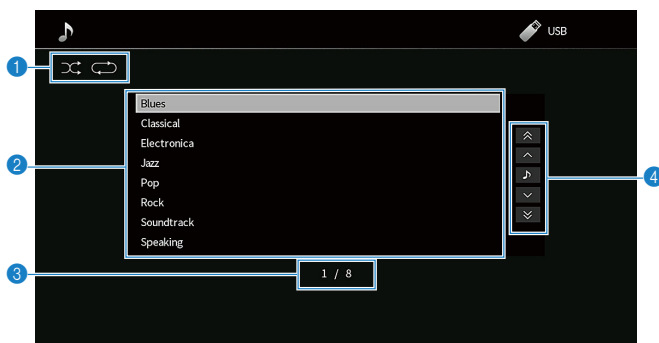

### 1 Status indicators

Display the current shuffle/repeat settings.

### 2 Contents list

Displays the list of contents. Use the cursor keys to select an item and press ENTER to confirm the selection.

### 3 Item number/total

### 4 Operation menu

Use the cursor keys to select an item. Press ENTER to confirm the selection.

Icon	Function
	Moves 10 pages backward.
	Moves to the previous page of the list.
	Moves to the playback screen.
	Moves to the next page of the list.
	Moves 10 pages forward.

### Note

- Displayed items vary depending on the content of playback.
- When "Video Out" in the "Option" menu is set to except "Off", you can close the browse screen by pressing the left cursor key. To display the browse screen again, press any cursor key. For details on "Video Out", see the following:
  - "Selecting a video source to be output with the selected audio source" (p.83)

## Listening to FM/AM radio

### Setting the frequency steps

(Asia and General models only)

At the factory, the frequency step setting is set to 50 kHz for FM and 9 kHz for AM. Depending on your country or region, set the frequency steps to 100 kHz for FM and 10 kHz for AM.

- 1 Set the unit to standby mode.
- 2 When holding down STRAIGHT on the front panel, press MAIN ZONE .

 (MAIN ZONE)

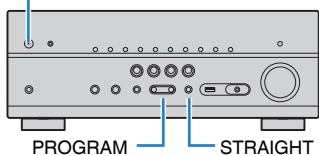

- 3 Press PROGRAM to select “TU”.

TU . . . . FM50/AM9

- 4 Press STRAIGHT to select “FM100/AM10”.

- 5 Press MAIN ZONE  to set the unit to standby mode and turn it on again.

This completes the settings.

## Selecting a frequency for reception

You can tune into a radio station by specifying its frequency.

### Note

The radio frequencies differ depending on the country or region where the unit is being used. The explanation of this section uses a display with frequencies used in U.K. and Europe models.

### 1 Press TUNER to select “TUNER” as the input source.

“TUNER” is selected as the input source and the frequency currently selected is displayed on the front display.



### 2 Press BAND to select a band (FM or AM).

### 3 Press TUNING to set a frequency.

Hold down the key for about a second to search stations automatically.

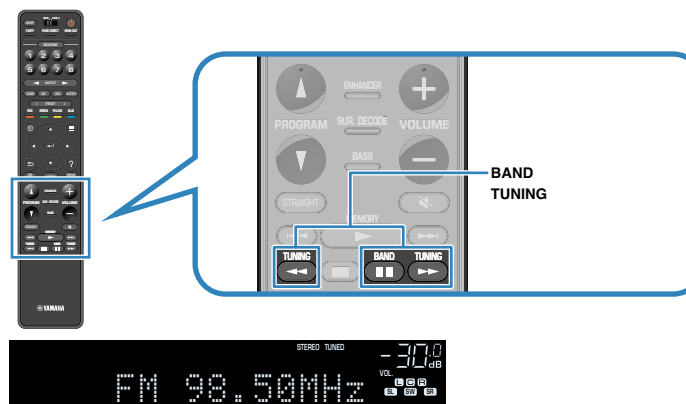

On the front display, “TUNED” lights up when the unit is receiving an FM/AM radio station signal.

“STEREO” lights up when the unit is receiving a stereo FM radio signal.

### Note

You can watch videos input from external devices while listening to radio. For details, see the following:

- “Selecting a video source to be output with the selected audio source” (p.83)

## Selecting a preset station

Tune into a registered radio station by selecting its preset number.

### 1 Press TUNER to select “TUNER” as the input source.

“TUNER” is selected as the input source and the frequency currently selected is displayed on the front display.

### 2 Press PRESET to select the desired radio station.

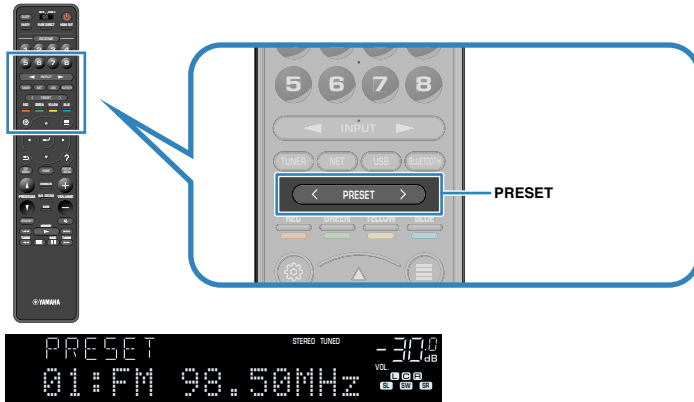

#### Note

“No Presets” appears on the front display when no radio stations are registered.

## Registering FM radio stations automatically (FM Auto Preset)

Automatically register FM radio stations with strong signals.

#### Note

- You can register up to 40 radio stations as presets.
- To register AM radio stations, see the following:
  - “Registering a radio station manually” (p.63)
- (U.K., Europe, Russia and Middle East models only)  
Only Radio Data System broadcasting stations are registered automatically by the Auto Preset function.

### 1 Press TUNER to select “TUNER” as the input source.

“TUNER” is selected as the input source and the frequency currently selected is displayed on the front display.

### 2 Press OPTION.

### 3 Use the cursor keys to select “Preset” and press ENTER.



The preset number from which to start the registration is displayed on the front display.

#### Note

To specify the preset number from which to start the registration, press cursor keys or PRESET to select a preset number.

### 4 To start the Auto Preset process, press ENTER.

“SEARCH” appears during Auto Preset



Preset number from which to start the registration

The Auto Preset process starts and “SEARCH” appears during Auto Preset.

#### Note

To cancel the Auto Preset process, press RETURN.

When the Auto Preset process finishes, “FINISH” appears on the front display and the “Option” menu closes automatically.



## Registering a radio station manually

Select a radio station manually and register it to a preset number.

### Note

You can register up to 40 radio stations as presets.

### 1 Press TUNER to select “TUNER” as the input source.

“TUNER” is selected as the input source and the frequency currently selected is displayed on the front display.

### 2 Press BAND to select a band (FM or AM).

### 3 Press TUNING to set a frequency.

Hold down the key for about a second to search stations automatically.

### 4 Hold down MEMORY for a few seconds.

The first time that you do register a station, the selected radio station will be registered to the preset number “01”. Thereafter, each radio station you select will be registered to the next empty (unused) preset number after the most recently registered number.

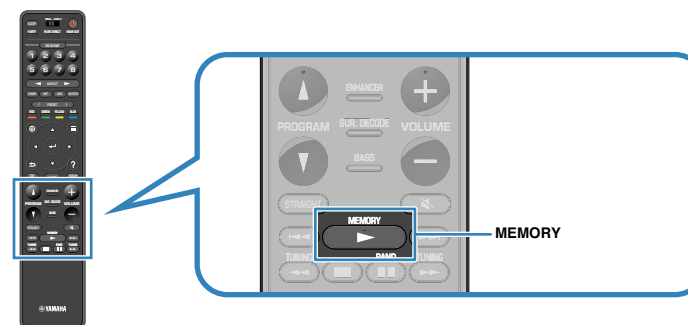

Preset number

### Note

To select a preset number for registering, press MEMORY once after tuning into the desired radio station, press PRESET to select a preset number, and then press MEMORY again.

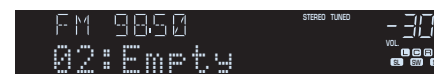

“Empty” (not in use) or the frequency currently registered

This completes the registers.

## Clearing preset stations

Clear radio stations registered to the preset numbers.

### 1 Press TUNER to select “TUNER” as the input source.

“TUNER” is selected as the input source and the frequency currently selected is displayed on the front display.

### 2 Press OPTION.

### 3 Use the cursor keys to select “Preset” and press ENTER.

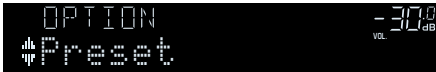

### 4 Use the cursor keys to select “CLEAR”.

### 5 Use the cursor keys to select a preset station to be cleared and press ENTER.



Preset station to be cleared

If the preset station is cleared, “Cleared” appears and then the next in-use preset number is displayed.



### 6 Repeat step 5 until all desired preset stations are cleared.

### 7 Press OPTION.

This completes the clearing preset stations.

## Clearing all preset stations

Clear all the radio stations registered to the preset numbers.

### 1 Press TUNER to select “TUNER” as the input source.

“TUNER” is selected as the input source and the frequency currently selected is displayed on the front display.

### 2 Press OPTION.

### 3 Use the cursor keys to select “Preset” and press ENTER.

### 4 Use the cursor keys to select “CLEAR ALL”.

### 5 Use the cursor keys to select “Execute” and press ENTER.

If all the preset stations are cleared, “CLEAR ALL” appears and the “Option” menu closes automatically.



## Displaying the Radio Data System information

(U.K., Europe, Russia and Middle East models only)

Radio Data System is a data transmission system used by FM stations in many countries. The unit can receive various types of Radio Data System data, such as "Program Service", "Program Type", "Radio Text" and "Clock Time", when it is tuned into a Radio Data System broadcasting station.

### 1 Tune into the desired Radio Data System broadcasting station.

#### Note

We recommend using "Auto Preset" to tune into the Radio Data System broadcasting stations. For details, see the following:

- "Registering FM radio stations automatically (FM Auto Preset)" (p.62)

### 2 Press INFO on the front panel to select between the various display items.



Item name

About 3 seconds after a display item is selected, its corresponding information appears.



Information

<b>Program Service</b>	Program service name
<b>Program Type</b>	Current program type
<b>Radio Text</b>	Information on the current program
<b>Clock Time</b>	Current time
<b>DSP Program</b>	Sound mode name
<b>Audio Decoder</b>	Decoder name
<b>Frequency</b>	Frequency

#### Note

"Program Service", "Program Type", "Radio Text", and "Clock Time" are not displayed if the radio station does not provide the Radio Data System service.

## Receiving traffic information automatically

(U.K., Europe, Russia and Middle East models only)

When "TUNER" is selected as the input source, the unit automatically receives traffic information. To enable this function, perform the following procedure to set the traffic information station.

- 1 When "TUNER" is selected as the input source, press **OPTION**.
- 2 Use the cursor keys to select "Traffic Program" and press **ENTER**.

The traffic information station search will start in 5 seconds. Press **ENTER** again to start the search immediately.

#### Note

- To search upward/downward from the current frequency, press the cursor keys while "READY" is displayed.
- To cancel the search, press **RETURN**.

The following screen appears for about 3 seconds when the search finishes.



Traffic information station (frequency)

#### Note

"TP Not Found" appears for about 3 seconds when no traffic information stations are found.

# Playing back music stored on a Bluetooth® device

## Playback Bluetooth® device music on the unit

You can play back music files stored on a Bluetooth device (such as smartphones) on the unit.

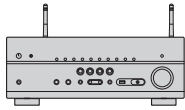

The unit



Bluetooth device  
(such as smartphones)

### Note

- Use the wireless antennas that are standing upright for connecting to a Bluetooth device wirelessly. For details, see the following:
  - “Preparing wireless antennas (wireless connection)” (p.34)
- To use the Bluetooth function, turn on the Bluetooth function of a Bluetooth device.
- To use the Bluetooth function, set “Bluetooth” in the “Setup” menu to “On”. For details, see the following:
  - “Setting the use of Bluetooth™” (p.120)
- For details on supported Bluetooth devices, see the following:
  - “Supported Bluetooth® devices” (p.167)

### 1 Press **BLUETOOTH** to select “Bluetooth” as the input source.

### 2 On the Bluetooth device, select the unit (network name of the unit).

A connection between the Bluetooth device and the unit will be made.

If the pass key is required, enter the number “0000”.

### 3 On the Bluetooth device, select a song and start playback.

The playback screen is displayed on the TV.

### Note

- If the unit detects the Bluetooth device previously connected, the unit automatically connects to the Bluetooth device after Step 1. To establish another Bluetooth connection, first terminate the current Bluetooth connection.
- To terminate the Bluetooth connection, perform one of the following operations.
  - Perform the disconnect operation on the Bluetooth device.
  - Select an input source other than “Bluetooth” on the unit.
  - Select “Disconnect” in “Audio Receive” in the “Setup” menu.

# Playing back music with AirPlay

## Playback of iTunes/iPhone music contents with AirPlay

The AirPlay allows you to play back iTunes or iPhone/iPad/iPod touch music on the unit via network.

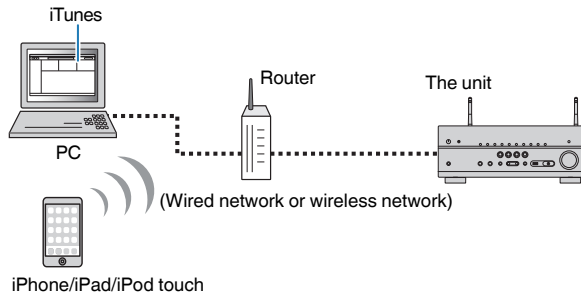

### Note

For details on supported iPhone devices, see the following:

- "Supported AirPlay devices" (p.167)

**1 Start iTunes on the PC or display the playback screen on the iPhone.**

**2 On the iTunes/iPhone, click (tap) the AirPlay icon and select the unit (network name of the unit) as the audio output device.**

iOS 10 (example)

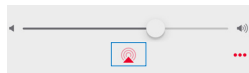

iTunes (example)



**3 Select a song and start playback.**

The unit automatically selects "AirPlay" as the input source and starts playback.

The playback screen is displayed on the TV.



### Caution

- When you use iTunes/iPhone controls to adjust volume, the volume may be unexpectedly loud. This could result in damage to the unit or speakers. If the volume suddenly increases during playback, stop playback on the iTunes/iPhone immediately. We recommend volume controls from iTunes/iPhone within the limited range by setting "AirPlay Volume Interlock" in the "Setup" menu.

### Note

- You can turn on the unit automatically when starting playback on iTunes or iPhone. For details on the settings, see the following:
  - "Setting the use of the Network Standby function" (p.117)
- You can edit the network name (the unit's name on the network) displayed on iTunes/iPhone. For details, see the following:
  - "Setting the network name of the unit" (p.119)
- You can adjust the unit's volume from the iTunes/iPhone during playback. To disable volume controls from iTunes/iPhone, see the following:
  - "Setting the use of volume control via AirPlay" (p.118)

# Playing back music stored on a USB storage device

## Playback of USB storage device contents

You can play back music files stored on a USB storage device on the unit.

### Note

For details on playable USB devices and USB file formats, see the following:

- “Supported USB devices” (p.167)
- “Supported file formats” (p.168)

### 1 Connect the USB storage device to the USB jack.

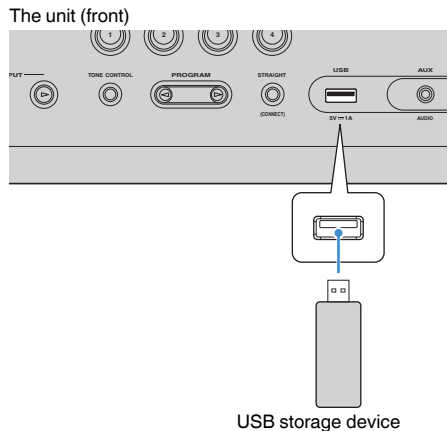

### Note

- If the USB storage device contains many files, it may take time to load them. In this case, “Loading...” appears on the front display.
- Stop playback of the USB storage device before disconnecting it from the USB jack.
- Connect a USB storage device directly to the USB jack of the unit. Do not use extension cables.
- The unit cannot charge USB devices while it is in standby mode.

### 2 Press USB to select “USB” as the input source.

The browse screen is displayed on the TV.

### Note

If playback is ongoing on your USB storage device, the playback screen is displayed.

### 3 Use the cursor keys to select an item and press ENTER.

If a song is selected, playback starts and the playback screen is displayed.

### Note

To return to the top level while on the browse screen, hold down RETURN.

### Note

- You can configure the shuffle/repeat settings for playback of contents. For details, see the following:
  - “Configuring the shuffle setting” (p.84)
  - “Configuring the repeat setting” (p.84)
- You can register contents as shortcuts and access them directly. For details, see the following:
  - “Registering a favorite content as shortcut” (p.76)

## Playing back music stored on media servers (PCs/NAS)

### Media sharing setup on media servers (PCs/NAS)

To play back music files stored on your media servers, first you need to configure the media sharing setting on each music server.

The setting procedure may vary depending on the media server. The following procedure is a setup example for Windows Media Player 12.

#### Note

- For a media server with software except Windows Media Player installed, refer to the instruction manual for the device or software and configure the media sharing settings.
- The setting procedure may vary depending on the view setting of Windows Media Player or the settings of PC.

- 1 Start Windows Media Player 12 on your PC.**
- 2 Select “Stream”, then “Turn on media streaming”.**
- 3 Click “Turn on media streaming”.**
- 4 Select “Allowed” from the drop-down list next to the unit’s model name.**
- 5 Click “OK” to exit.**

This completes the settings.

#### Note

For details on media sharing settings, refer to Windows Media Player help.

### Playing back music stored on media servers (PCs/NAS)

You can play back music files stored on your media server on the unit.

#### Note

- You need to configure the media sharing setting on each music server in advance. For details, see the following:
  - “Media sharing setup on media servers (PCs/NAS)” (p.69)
- To use this function, the unit and your PC must be connected to the same router. You can check whether the network parameters (such as the IP address) are properly assigned to the unit. For details, see the following:
  - “Checking the network information on the unit” (p.116)
- The audio may be interrupted while using the wireless network connection. In this case, use the wired network connection.
- For details on playable file formats, see the following:
  - “Supported file formats” (p.168)

### 1 Press NET to select “SERVER” as the input source.

The browse screen is displayed on the TV.

#### Note

If playback of a music file selected from the unit is ongoing on your PC, the playback screen is displayed.

### 2 Use the cursor keys to select a music server and press ENTER.

### **3 Use the cursor keys to select an item and press ENTER.**

If a song is selected, playback starts and the playback screen is displayed.

#### **Note**

To return to the top level while on the browse screen, hold down RETURN.

#### **Note**

- You can configure the shuffle/repeat settings for playback of contents. For details, see the following:
  - “Configuring the shuffle setting” (p.84)
  - “Configuring the repeat setting” (p.84)
- You can also use the Digital Media Controller (DMC) to control playback. For details, see the following:
  - “Setting the use of a Digital Media Controller” (p.118)
- You can register contents as shortcuts and access them directly. For details, see the following:
  - “Registering a favorite content as shortcut” (p.76)

### Selecting an Internet radio station

Select an Internet radio station and start playback.

#### Note

- To use this function, the unit must be connected to the Internet. You can check whether the network parameters (such as the IP address) are properly assigned to the unit. For details, see the following:
  - “Checking the network information on the unit” (p.116)
- You may not be able to receive some Internet radio stations.
- The unit uses the `airable.Radio service`. `airable` is a service of Tune In GmbH.
- This service may be discontinued without notice.
- Folder names are different depending on the language.

#### 1 Press NET to select “NET RADIO” as the input source.

The browse screen is displayed on the TV.

#### 2 Use the cursor keys to select an item and press ENTER.

If an Internet radio station is selected, playback starts and the playback screen is displayed.

#### Note

To return to the top level while on the browse screen, hold down RETURN.

### Registering favorite Internet radio stations

You can register the Internet radio station in playback at present to the “Favorites” folder.

#### 1 While listening to Internet radio, press OPTION.

#### 2 Use the cursor keys to select “Add to favorites” and press ENTER.

On the playback screen, the current station is added to the “Favorites” folder. On the browse screen, the station selected in the list is added to the “Favorites” folder.

When the registering process finishes, the “Option” menu closes automatically.

#### Note

- Radio stations registered to favorites are displayed with “★”.
- To remove a station that is registered to favorites, select the station and then select “Remove from favorites”.
- You can register Internet radio stations as shortcuts and access them directly. For details, see the following:
  - “Registering a favorite content as shortcut” (p.76)

### Listening to a streaming service

---

You can listen to a streaming service with the MusicCast CONTROLLER on your mobile device. On the MusicCast CONTROLLER screen, select the room name that was specified for the unit, and then select the streaming service to be tuned into by its station name. For details, see the MusicCast CONTROLLER app.

#### Note

- Service is limited to certain areas.
- Services supported with the unit may not be available depending upon some regions where the unit is purchased.
- Service may change or be discontinued without notice.
- After registering the unit in the MusicCast CONTROLLER app, you can use the streaming service. For details, see the following:
  - “Adding the unit to the MusicCast network” (p.44)
- To use this function, the unit must be connected to the Internet. You can check whether the network parameters (such as the IP address) are properly assigned to the unit. For details, see the following:
  - “Checking the network information on the unit” (p.116)
- For details on music streaming services, see the supplements for streaming services. Access the Yamaha Downloads site to download the supplement.  
<http://download.yamaha.com/>



## Useful playback functions

### SCENE function

#### Selecting the input source and favorite settings with one touch (SCENE)

The SCENE function allows you to select the following settings with just one touch.

- Input source
- Registered content
- Sound program
- Pure Direct On/Off
- Compressed Music Enhancer On/Off
- HDMI output jack

You can register eight SCENE functions that are assigned to eight SCENE keys on the remote control respectively.

#### Selecting a registered scene

Press numbered key (1 to 8), and then the input source and settings registered to the corresponding scene are directly selected. The unit turns on automatically when it is in standby mode.

##### Note

To control Zone2, set MAIN/ZONE 2 to "ZONE 2".

Alternatively, you can also select a registered scene by pressing SCENE repeatedly.

#### 1 Press SCENE repeatedly.

The SCENE name appears on the front display and on the TV.

#### 2 To select a desired SCENE name, press ENTER.

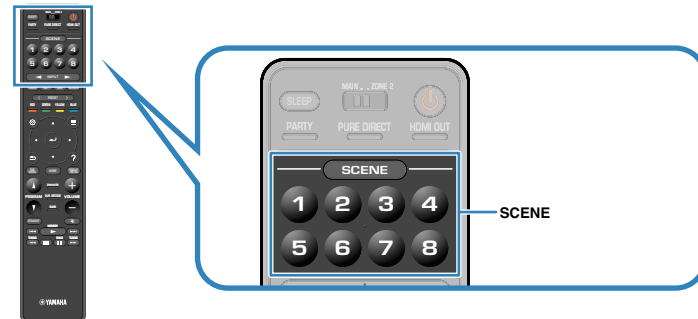

##### Note

- To cancel the operation of selecting a registered scene, press RETURN.
- The operation is canceled automatically when you have not operated the unit for the 30 seconds.

By default, the following settings are registered for each scene.

## Main Zone

SCENE	1	2	3	4
<b>SCENE name</b>	Movie Viewing	Radio Listening	Music Listening	NET Audio Listening
<b>Input</b>	HDMI1	TUNER	AUDIO2	NET RADIO
<b>HDMI output</b>	HDMI OUT 1+2	HDMI OUT 1+2	HDMI OUT 1+2	HDMI OUT 1+2
<b>Sound program</b>	Sci-Fi	7ch Stereo	STRAIGHT	7ch Stereo
<b>Pure Direct</b>	Off	Off	Off	Off
<b>Compressed Music Enhancer</b>	Off	On	Off	On

SCENE	5	6	7	8
<b>SCENE name</b>	STB Viewing	Game Playing	TV Viewing	Media Server Listening
<b>Input</b>	HDMI2	HDMI3	AUDIO1	SERVER
<b>HDMI output</b>	HDMI OUT 1+2	HDMI OUT 1+2	HDMI OUT 1+2	HDMI OUT 1+2
<b>Sound program</b>	Drama	Action Game	Drama	7ch Stereo
<b>Pure Direct</b>	Off	Off	Off	Off
<b>Compressed Music Enhancer</b>	Off	Off	On	On

## Zone2

SCENE	1	2	3	4
<b>Input</b>	AV 1	TUNER	AUDIO2	NET RADIO
<b>Volume</b>	-40.0 dB	-40.0 dB	-40.0 dB	-40.0 dB
<b>Tone Control</b>	Auto	Auto	Auto	Auto

SCENE	5	6	7	8
<b>Input</b>	AUDIO3	AUDIO4	AUDIO1	SERVER
<b>Volume</b>	-40.0 dB	-40.0 dB	-40.0 dB	-40.0 dB
<b>Tone Control</b>	Auto	Auto	Auto	Auto

### Note

- You can also select a registered scene 1 to 4 by pressing SCENE numbered key (1 to 4) on the front panel.
- For details on the settings, see the following:
  - “Selecting items to be included as the scene assignments” (p.111)

## ■ Registering a scene

You can change the default setting and register the function that is assigned to each numbered key (1 to 8).

### Note

- We recommend registering the scene with playing back the content that you want to register.
- To control Zone2, set MAIN/ZONE 2 to "ZONE 2".

## 1 Perform the following operations to prepare the settings you want to assign to a scene.

- Select an input source
- Select the assigned radio station or content (when "NET", "USB", "Bluetooth" or "TUNER" is selected for the input source only)
- Select a sound Program, straight decode or Pure Direct
- Enable/disable Compressed Music Enhancer
- Select an HDMI output jack

## 2 Hold down the desired numbered key (1 to 8) until "SET Complete" appears on the front display or on the TV.



This completes the registers.

### Note

- For details on the settings, see the following:
  - "Enjoying sound field effects optimized for the type of content" (p.46)
  - "Enjoying pure high fidelity sound (Pure Direct)" (p.48)
  - "Playing back digitally compressed formats with enriched sound (Compressed Music Enhancer)" (p.49)
  - "Selecting an HDMI output jack" (p.57)
- You can configure more detailed scene assignments in "Scene" in the "Setup" menu. For details, see the following:
  - "Selecting items to be included as the scene assignments" (p.111)
- You can change the SCENE name displayed on the front display or on the TV. For details, see the following:
  - "Renaming the SCENE name" (p.112)

## Shortcut function

### ■ Registering a favorite content as shortcut

You can register favorite Bluetooth, USB, media server and network content as shortcuts and access them directly by selecting the shortcut numbers.

#### Note

- You can register up to 40 contents as shortcuts.
- You can also use the “Favorites” feature to register Internet radio stations. For details, see the following:
  - “Registering favorite Internet radio stations” (p.71)
- The unit registers Bluetooth or AirPlay as an input source. No individual content can be registered.

### 1 Play back a song or a radio station to be registered.

### 2 Hold down MEMORY for a few seconds.

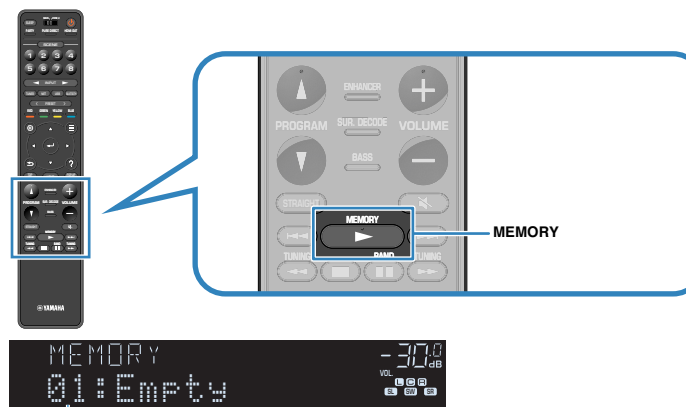

Shortcut number (flashes)

“MEMORY” appears on the front display and the shortcut number to which the item will be registered blinks.

#### Note

To change a shortcut number to which the item will be registered, use PRESET to select the shortcut number after step 2.



“Empty” (not in use) or item currently registered

### 3 Press MEMORY.

The registered shortcut number and “Memorized” appear on the front display.

This completes the registers.

## ■ Recalling a registered content as shortcut

Recall a registered content (Bluetooth, USB, media server and network content) by selecting the shortcut number.

### Note

You can register up to 40 contents as shortcuts.

### 1 Press BLUETOOTH, NET or USB.

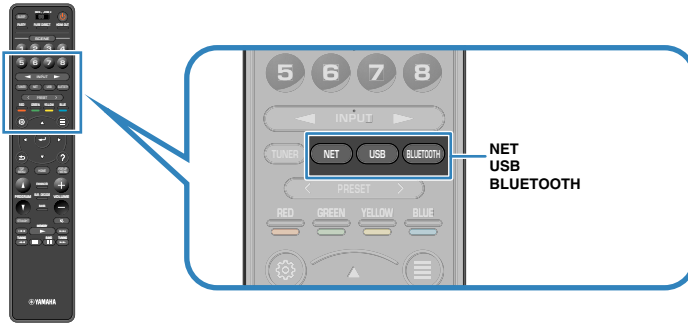

### 2 Press PRESET to select a desired content.

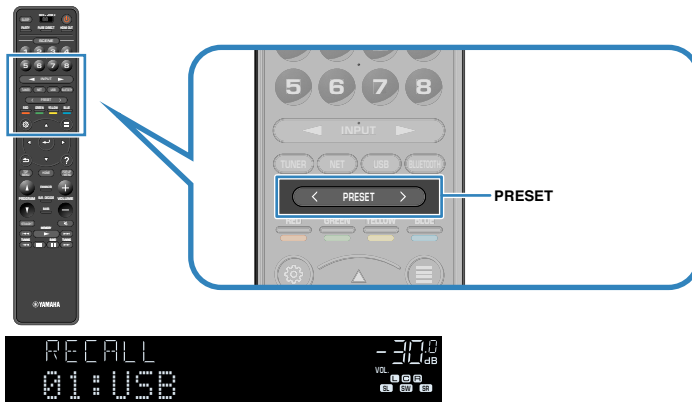

Playback of the selected content starts.

### Note

- "No Presets" appears on the front display when no items are registered.
- The registered item cannot be recalled in the following cases.
  - A USB storage device which contains the registered item is not connected to this unit.
  - A PC which contains the registered item is turned off or not connected to the network.
  - The registered network content is temporarily unavailable or out of service.
  - The registered item (file) has been deleted or moved to another location.
  - A Bluetooth connection cannot be established.
- When you register music files stored on a USB storage device or a media server (PC/NAS), this unit memorizes the relative position of the music files in the folder. If you have added or deleted any music files to or from the folder, this unit may not recall the music file correctly. In such cases, register the items again.
- The registered content (songs and Internet radio stations) can be displayed as a list and easily removed by using MusicCast CONTROLLER on your mobile device. For details, see the following:
  - "Using MusicCast CONTROLLER" (p.44)

# Configuring playback settings for different playback sources (Option menu)

## Basic operation of the Option menu

Perform the following basic procedure to operate the "Option" menu. With the "Option" menu, you can configure different playback settings according to the input source currently being played back.

### 1 Press OPTION.

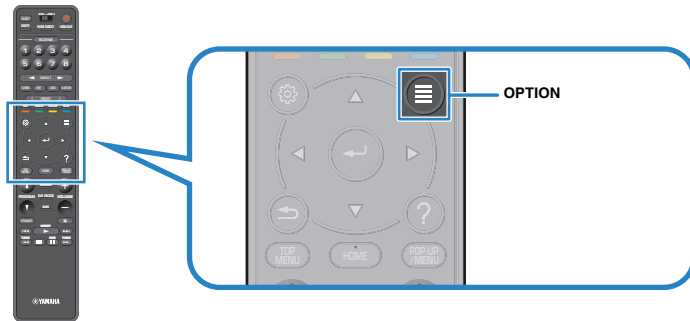

Front display

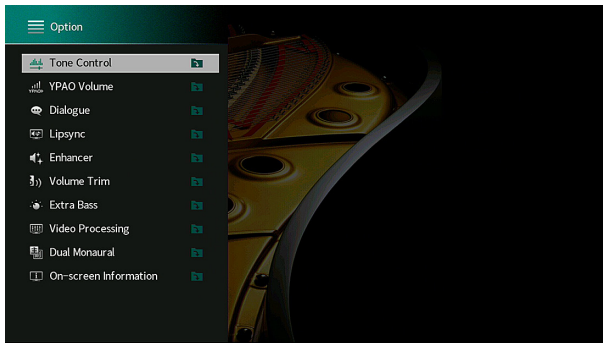

TV screen

### 2 Use the cursor keys to select an item and press ENTER.

### 3 Use the cursor keys to select a setting.

### 4 Press OPTION.

This completes the settings.

#### Note

For details on the default settings, see the following:

- "Default settings of the Option menu" (p.178)

## Option menu items

Use the following table to configure playback settings of the unit.

### Note

- Available items vary depending on the selected input source.
- When the input icon is displayed on the upper right of the “Option” menu, the setting is applied to the currently selected input source. Otherwise, the setting is applied to all of the input sources.
- Text in parentheses denotes indicators on the front display.
- Depending on the region of purchase, some menu items for audio streaming services are also available.

Item	Function	Page
<b>Tone Control (Tone Control)</b>	Adjusts the level of high-frequency range and low-frequency range individually.	p.79
<b>YPAO Volume (YPAO Volume)</b>	<b>YPAO Volume (YPAO Vol.)</b>	Enables/disables YPAO Volume. p.80
	<b>Adaptive DRC (A.DRC)</b>	Sets whether the dynamic range (from maximum to minimum) is automatically adjusted to the volume. p.80
<b>Dialogue (Dialog)</b>	<b>Dialogue Level (Dialog Lvl)</b>	Adjusts the volume of dialogue sounds. p.81
	<b>DTS Dialogue Control (DTS Dialog)</b>	Adjusts the volume of dialogue sounds for DTS:X contents. p.81
	<b>Dialogue Lift (Dialog Lift)</b>	Adjusts the perceived height of dialogue sounds for the screen position. p.81
<b>Lipsync (Lipsync)</b>	<b>Lipsync (Lipsync)</b>	Adjusts the delay between video and audio output manually. p.82
<b>Enhancer (Enhancer)</b>	<b>Enhancer (Enhancer)</b>	Enables/disables Compressed Music Enhancer. p.82
<b>Volume Trim (Volume Trim)</b>	<b>Input Trim (In.Trim)</b>	Corrects volume differences between input sources. p.82
	<b>Subwoofer Trim (SW.Trim)</b>	Fine-adjusts the subwoofer volume. p.82
<b>Extra Bass (Extra Bass)</b>	<b>Extra Bass (Extra Bass)</b>	Enables/disables Extra Bass. p.83
<b>Video Processing (Video Process.)</b>	<b>Video Mode (V.M)</b>	Enables/disables the video signal processing settings configured in the “Setup” menu. p.83
<b>Video Out (Video Out)</b>	<b>Video Out (V.Out)</b>	Selects a video to be output with the selected audio source. p.83

Item	Function	Page
<b>Shuffle / Repeat (Shuffle / Repeat)</b>	<b>Shuffle (Shuffle)</b>	Configures the shuffle setting. p.84
	<b>Repeat (Repeat)</b>	Configures the repeat setting. p.84
<b>FM Mode (FM Mode)</b>	<b>FM Mode (Mode)</b>	Switches between “Stereo” and “Monaural” for FM radio reception. p.84
	<b>FM Auto Preset (AUTO)</b>	Automatically registers FM radio stations with strong signals as presets. p.85
<b>Preset (Preset)</b>	<b>Clear Preset (CLEAR)</b>	Clears radio stations registered to preset numbers. p.86
	<b>Clear All Preset (CLEAR ALL)</b>	Clears all the radio stations registered to preset numbers. p.86
<b>Add to favorites (Add to Fav.)</b>	Adds your favorite Internet radio station to the “Favorites” folder. p.87	
<b>Remove from favorites (RemovefromFav.)</b>	Removes it from the “Favorites” folder. p.87	
<b>Traffic Program (TrafficProgram)</b>	(U.K., Europe, Russia and Middle East models only) Automatically searches for a traffic information station. p.87	
<b>On-screen Information</b>	Displays the current status information. p.88	

## Adjusting the tone of the audio output

Adjusts the level of high-frequency range (Treble) and low-frequency range (Bass) individually.

### Option menu

“Tone Control”

### Choices

Treble, Bass

### Setting range

-6.0 dB to +6.0 dB (0.5 dB increments)

### Note

- When both “Treble” and “Bass” are 0.0 dB, “Bypass” appears.
- You can also adjust the tone with the front panel controls. Press TONE CONTROL to select “Treble” or “Bass”, then press PROGRAM to make an adjustment.
- If you set an extreme value, sounds may not match those from other channels.

## Configuring the volume automatically based on the YPAO measurement results

### ■ Adjusting the high- and low-frequency levels automatically according to the volume

Enables/disables YPAO Volume. When YPAO Volume is enabled, the high- and low-frequency levels are automatically adjusted according to the volume so that you can enjoy natural sounds even at low volume. YPAO Volume works effectively after the YPAO measurement. For details, see the following:

- “Optimizing the speaker settings automatically (YPAO)” (p.38)

#### Option menu

“YPAO Volume” > “YPAO Volume”

#### Settings

Off	Disables YPAO Volume.
On	Enables YPAO Volume.

#### Note

We recommend enabling both “YPAO Volume” and “Adaptive DRC” when you are listening at lower volumes or at night. For details on “Adaptive DRC”, see the following:

- “Adjusting the dynamic range automatically” (p.80)

### ■ Adjusting the dynamic range automatically

Sets whether the dynamic range (from maximum to minimum) is automatically adjusted to the volume when “YPAO Volume” is set to “On”. When “Adaptive DRC” is set to “On”, it is useful for listening to playback at a low volume at night.

#### Option menu

“YPAO Volume” > “Adaptive DRC”

#### Settings

Off	The dynamic range is not automatically adjusted.
On	Automatically adjusts the dynamic range.

#### Note

We recommend enabling both “YPAO Volume” and “Adaptive DRC” when you are listening at lower volumes or at night. For details on “YPAO Volume”, see the following:

- “Adjusting the high- and low-frequency levels automatically according to the volume” (p.80)



## Adjusting the volume or perceived height of dialogue sounds

### ■ Adjusting the volume of dialogue sound

Adjusts the volume of dialogue sounds that are hardly heard.

#### Option menu

“Dialogue” > “Dialogue Level”

#### Setting range

0 to 3 (higher to strengthen)

#### Note

This setting is not available when one of the following conditions is met.

- Dolby Atmos content or DTS:X content is played back.
- The Dolby Surround or Neural:X decoder is working.

### ■ Adjusting the volume of dialogue sound during DTS:X™ playback

Adjusts the volume of dialogue sounds that are hardly heard for DTS:X content.

#### Option menu

“Dialogue” > “DTS Dialogue Control”

#### Setting range

0 to 6 (higher to strengthen)

#### Note

This setting is available only when DTS:X content which supports the DTS Dialogue Control feature is played back.

### ■ Adjusting the perceived height of dialogue sound

Adjusts the perceived height of dialogue sounds when the position (height) of dialogue sound is artificial. If the dialogue sounds as if it is coming from below the screen, you can raise its perceived height by increasing this setting.

#### Note

This setting is available only when one of the following conditions is met.

- One of the sound programs (except for 2ch Stereo and 7ch Stereo) is selected when presence speakers are used.
- Virtual Presence Speaker (VPS) is working.  
(You may hear dialogue sounds from the surround speakers depending on the listening position.)

#### Option menu

“Dialogue” > “Dialogue Lift”

#### Setting range

0 to 5 (The bigger the value the higher the position)

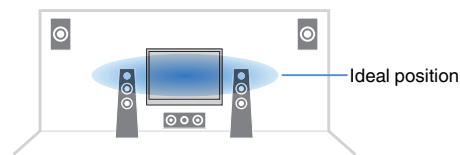

## Adjusting the delay of the Lipsync function

Adjusts the delay between video and audio output manually when “Delay Enable” in the “Setup” menu is set to “Enable”.

### Option menu

“Lipsync” > “Lipsync”

### Setting range

0 ms to 500 ms (1 ms increments)

### Note

For details on “Delay Enable” in the “Setup” menu, see the following:

- “Enabling Lipsync adjustment” (p.101)

## Setting Compressed Music Enhancer

Enables/disables Compressed Music Enhancer.

### Option menu

“Enhancer” > “Enhancer”

### Settings

Off	Disables Compressed Music Enhancer.
On	Enables Compressed Music Enhancer.

### Note

- This setting is applied separately to each input source.
- You can also use ENHANCER on the remote control to enable/disable Compressed Music Enhancer.
- For details on Compressed Music Enhancer, see the following:
  - “Playing back digitally compressed formats with enriched sound (Compressed Music Enhancer)” (p.49)

## Correcting volume differences during playback

### ■ Correcting volume differences between input sources

Corrects volume differences between input sources. If you are bothered by volume differences when switching between input sources, use this function to correct it.

### Option menu

“Volume Trim” > “Input Trim”

### Setting range

-6.0 dB to +6.0 dB (0.5 dB increments)

### Note

This setting is applied separately to each input source.

### ■ Adjusting the subwoofer volume

Fine-adjusts the subwoofer volume.

### Option menu

“Volume Trim” > “Subwoofer Trim”

### Setting range

-6.0 dB to +6.0 dB (0.5 dB increments)

## Setting the use of Extra Bass

Enables/disables Extra Bass. When Extra Bass is enabled, you can enjoy enhanced bass sounds, regardless of the size of the front speakers and the presence or absence of the subwoofer.

### Option menu

"Extra Bass" > "Extra Bass"

### Settings

---

Off	Disables Extra Bass.
On	Enables Extra Bass.

---

### Note

You can also use BASS on the remote control to enable/disable Extra Bass.

## Enabling the video signal processing

Enables/disables the video signal processing (resolution and aspect ratio) settings configured in "Resolution" and "Aspect" in the "Setup" menu. For details, see the following:

- "Setting a resolution to output HDMI video signals" (p.113)
- "Setting an aspect ratio to output HDMI video signals" (p.114)

### Option menu

"Video Processing" > "Video Mode"

### Settings

---

Direct	Disables the video signal processing.
Processing	Enables the video signal processing.

---

## Selecting a video source to be output with the selected audio source

Selects a video source to be output together with the selected audio source. For example, you can watch the video from a different source while listening to the radio.

### Option menu

"Video Out" > "Video Out"

### Input sources

AUX, AUDIO 1-5, PHONO, TUNER, (network sources), AirPlay, MusicCast Link, SERVER, NET RADIO, Bluetooth, USB

### Settings

---

Off	Does not output video.
HDMI 1-5, AV 1-2	Outputs video input through the corresponding video input jacks.

---

## Configuring the shuffle/repeat setting

---

### ■ Configuring the shuffle setting

Configure the shuffle setting for playback.

#### Option menu

"Shuffle / Repeat" > "Shuffle"

#### Settings

Off	Turns off the shuffle function.
On	Plays back songs in the current album (folder) in random order.

#### Note

This setting is available only when "USB" or "SERVER" is selected as the input source.

### ■ Configuring the repeat setting

Configure the repeat setting for playback.

#### Option menu

"Shuffle / Repeat" > "Repeat"

#### Settings

Off	Turns off the repeat function.
One	Plays back the current song repeatedly.
All	Plays back all songs in the current album (folder) repeatedly.

#### Note

This setting is available only when "USB" or "SERVER" is selected as the input source.

## Switching between stereo and monaural for FM radio reception

---

Switch between stereo and monaural for FM radio reception. When the signal reception for an FM radio station is unstable, switching to monaural may improve it.

#### Option menu

"FM Mode" > "FM Mode"

#### Settings

Stereo	Enables stereo for FM radio reception.
Monaural	Enables monaural for FM radio reception.

## Setting presets for radio stations

### ■ Registering FM radio stations automatically

Automatically register FM radio stations with strong signals.

#### Note

- You can register up to 40 radio stations as presets.
- To register AM radio stations, see the following:
  - “Registering a radio station manually” (p.63)
- (U.K., Europe, Russia and Middle East models only)  
Only Radio Data System broadcasting stations are registered automatically by the Auto Preset function.

#### Option menu

“Preset” > “FM Auto Preset”

#### 1 Press TUNER to select “TUNER” as the input source.

“TUNER” is selected as the input source and the frequency currently selected is displayed on the front display.

#### 2 Press OPTION.

#### 3 Use the cursor keys to select “Preset” and press ENTER.



The preset number from which to start the registration is displayed on the front display.

#### Note

To specify the preset number from which to start the registration, press cursor keys or PRESET to select a preset number.

#### 4 To start the Auto Preset process, press ENTER.

“SEARCH” appears during Auto Preset



Preset number from which to start the registration

The Auto Preset process starts and “SEARCH” appears during Auto Preset.

#### Note

To cancel the Auto Preset process, press RETURN.

When the Auto Preset process finishes, “FINISH” appears on the front display and the “Option” menu closes automatically.



## ■ Clearing preset stations

Clear radio stations registered to the preset numbers.

### Option menu

“Preset” > “Clear Preset”

#### 1 Press TUNER to select “TUNER” as the input source.

“TUNER” is selected as the input source and the frequency currently selected is displayed on the front display.

#### 2 Press OPTION.

#### 3 Use the cursor keys to select “Preset” and press ENTER.

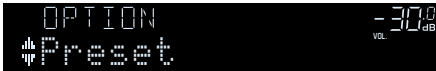

#### 4 Use the cursor keys to select “CLEAR”.

#### 5 Use the cursor keys to select a preset station to be cleared and press ENTER.



Preset station to be cleared

If the preset station is cleared, “Cleared” appears and then the next in-use preset number is displayed.



#### 6 Repeat step 5 until all desired preset stations are cleared.

#### 7 Press OPTION.

This completes the clearing preset stations.

## ■ Clearing all preset stations

Clear all the radio stations registered to the preset numbers.

### Option menu

“Preset” > “Clear All Preset”

#### 1 Press TUNER to select “TUNER” as the input source.

“TUNER” is selected as the input source and the frequency currently selected is displayed on the front display.

#### 2 Press OPTION.

#### 3 Use the cursor keys to select “Preset” and press ENTER.

#### 4 Use the cursor keys to select “CLEAR ALL”.

#### 5 Use the cursor keys to select “Execute” and press ENTER.

If all the preset stations are cleared, “CLEAR ALL” appears and the “Option” menu closes automatically.

## Adding an Internet radio station to the “Favorites” folder

Register the currently playing Internet radio station to the “Favorites” folder.

### Option menu

“Add to favorites”

- 1 While listening to Internet radio, press **OPTION**.
- 2 Use the cursor keys to select “Add to favorites” and press **ENTER**.

When the registering process finishes, the “Option” menu closes automatically.

## Removing an Internet radio station from the “Favorites” folder

Remove an Internet radio station from the “Favorites” folder.

### Option menu

“Remove from favorites”

- 1 Use the cursor keys to select the station to be removed from the “Favorites” folder.
- 2 Press **OPTION**.
- 3 Use the cursor keys to select “Remove from favorites” and press **ENTER**.

When the removing process finishes, the “Option” menu closes automatically.

## Receiving traffic information automatically

(U.K., Europe, Russia and Middle East models only)

When “TUNER” is selected as the input source, the unit automatically searches for a traffic information station.

### Option menu

“Traffic Program”

- 1 When “TUNER” is selected as the input source, press **OPTION**.
- 2 Use the cursor keys to select “Traffic Program” and press **ENTER**.

The traffic information station search will start in 5 seconds. Press **ENTER** again to start the search immediately.

### Note

- To search upward/downward from the current frequency, press the cursor keys while “READY” is displayed.
- To cancel the search, press **RETURN**.

The following screen appears for about 3 seconds when the search finishes.



Traffic information station (frequency)

### Note

“TP Not Found” appears for about 3 seconds when no traffic information stations are found.

## Checking the current status information

Displays the current status information as follows.

### Option menu

“On-screen Information”

- 1 Press **OPTION**.
- 2 Use the cursor keys to select “On-screen Information” and press **ENTER**.

The following information is displayed on the TV.

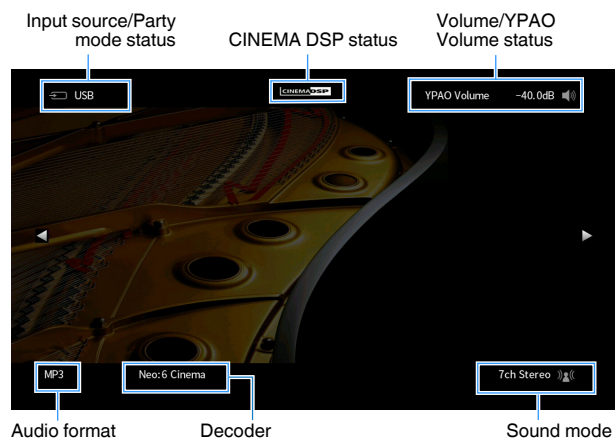

- 3 To close the information display, press **RETURN**.

### Note

- You can use the **PROGRAM** key on the remote control for displaying the status information on the TV. For details, see the following:
  - “Setting the function for the **PROGRAM** key on the remote control” (p.129)
- Use the left/right cursor keys to display other informations in the “Setup” menu on the TV.



# CONFIGURATIONS

## Configuring various functions (Setup menu)

### Basic operation of the Setup menu

Perform the following basic procedure to operate the “Setup” menu. You can configure the unit’s various functions with the “Setup” menu.

#### Note

- If new firmware is available, the message screen appears.
- If new firmware is available, the envelope icon (✉) appears in the screen.
- For details on firmware updating, see the following:
  - “Firmware updates” (p.151)

#### 1 Press SETUP.

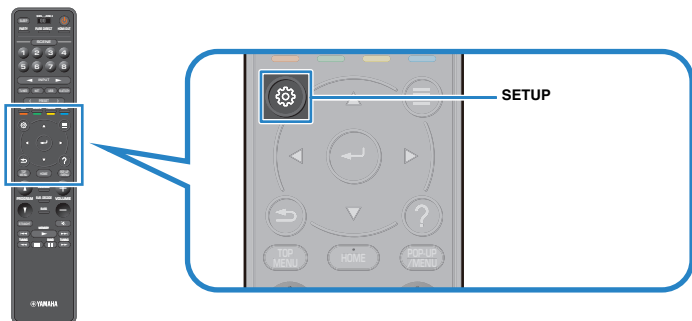

#### 2 Use the cursor keys to select a menu and press ENTER.

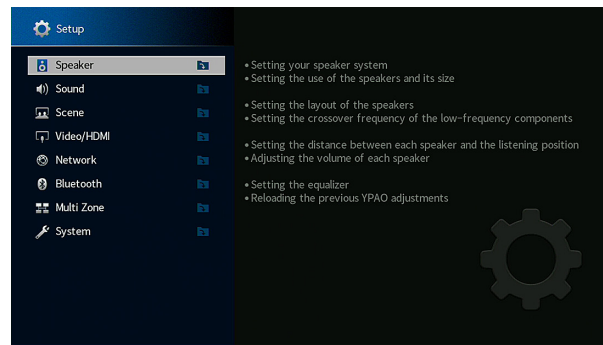

#### 3 Use the cursor keys to select an item and press ENTER.

#### 4 Use the cursor keys to select a setting and press ENTER.

#### 5 Press SETUP.

This completes the settings.

#### Note

For details on the default settings, see the following:

- “Default settings of the Setup menu” (p.178)

## Setup menu items

Use the following table to configure various functions of the unit.

Menu	Item	Function	Page	
Speaker	<b>Power Amp Assign</b>	Selects a speaker system.	p.94	
	<b>Configuration</b>	<b>Front</b>	Selects the size of the front speakers.	p.94
		<b>Center</b>	Selects whether or not a center speaker is connected and its size.	p.95
		<b>Surround</b>	Selects whether or not surround speakers are connected and their size.	p.95
		<b>Surround Back</b>	Selects whether or not surround back speakers are connected and their size.	p.96
		<b>Front Presence</b>	Selects whether or not presence speakers are connected and their size.	p.97
		<b>Subwoofer</b>	Selects whether or not a subwoofer is connected.	p.98
	<b>Distance</b>	Sets the distance between each speaker and listening position.	p.98	
	<b>Level</b>	Adjusts the volume of each speaker.	p.99	
	<b>Parametric EQ</b>	Adjusts the tone with an equalizer.	p.99	
	<b>Test Tone</b>	Enables/disables the test tone output.	p.100	
	<b>YPAO Result</b>	Checks and Reloads the previous YPAO adjustments.	p.100	
	Sound	<b>Information</b>	Displays information about the current audio signal.	p.101
<b>Lipsync</b>		<b>Delay Enable</b>	Enables/disables the "Lipsync" adjustment configured in "Auto/Manual Select".	p.101
		<b>Auto/Manual Select</b>	Selects the method to adjust the delay between video and audio output.	p.102
		<b>Adjustment</b>	Adjusts the delay between video and audio output manually.	p.102
<b>DSP Level</b>		Adjusts the sound field effect level.	p.104	
<b>Initial Delay</b>		Adjusts the delay between the direct sound and presence sound field generation.	p.104	
<b>Room Size</b>		Adjusts the broadening effect of the presence sound field.	p.104	
<b>Liveness</b>		Adjusts the loss of the presence sound field.	p.105	
<b>Reverb Time</b>		Adjusts the decay time of the rear reverberant sound.	p.105	
<b>Reverb Delay</b>		Adjusts the delay between the direct sound and reverberant sound generation.	p.105	
<b>DSP Parameter</b>		<b>Reverb Level</b>	Adjusts the volume of the reverberant sound.	p.105
		<b>Surround Initial Delay</b>	Adjusts the delay between the direct sound and surround sound field generation.	p.106
		<b>Surround Room Size</b>	Adjusts the broadening effect of the surround sound field.	p.106
		<b>Surround Liveness</b>	Adjusts the loss of the surround sound field.	p.106
		<b>Surround Back Initial Delay</b>	Adjusts the delay between the direct sound and surround back sound field generation.	p.106
		<b>Surround Back Room Size</b>	Adjusts the broadening effect of the surround back sound field.	p.107
		<b>Surround Back Liveness</b>	Adjusts the loss of the surround back sound field.	p.107

Menu	Item	Function	Page	
Sound	Surround Decoder	<b>Decode Type</b>	Selects a surround decoder to be used in combination with the selected sound program.	p.107
		<b>Center Spread</b>	Selects whether to spread the center channel signals to left and right when 2-channel source is played.	p.108
		<b>Center Image</b>	Adjusts the center localization (broadening effect) of the front sound field.	p.108
	7ch Stereo	<b>Level</b>	Adjusts the entire volume for "7ch Stereo".	p.108
		<b>Front / Rear Balance</b>	Adjusts the front and rear volume balance for "7ch Stereo".	p.108
		<b>Left / Right Balance</b>	Adjusts the left and right volume balance for "7ch Stereo".	p.108
		<b>Height Balance</b>	Adjusts the height volume balance using the presence speakers for "7ch Stereo".	p.109
		<b>Monaural Mix</b>	Enables/disables monaural sound output for "7ch Stereo".	p.109
	<b>Dynamic Range</b>	Selects the dynamic range adjustment method for bitstream audio (Dolby Digital and DTS signals) playback.	p.109	
	Volume	<b>Max Volume</b>	Sets the limit value of the volume.	p.109
		<b>Initial Volume</b>	Sets the initial volume for when this receiver is turned on.	p.110
	<b>Adaptive DSP Level</b>	Selects whether to automatically adjust the CINEMA DSP 3D effect level when the volume is adjusted.	p.110	
	<b>Virtual Speaker</b>	<b>VSBS</b>	Selects whether to create Virtual Surround Back Speaker (VSBS) using the surround speakers.	p.110
	Scene	<b>Scene Setting</b>	Selects items to be included as the scene assignments.	p.111
<b>Scene Rename</b>		Renames the scene name displayed on the front display or TV screen.	p.112	
Video/HDMI	<b>Information</b>	Displays information about the current video signal and the TVs connected to the HDMI OUT jacks.	p.113	
	Video Mode	<b>Video Mode</b>	Enables/disables the video signal processing.	p.113
		<b>Resolution</b>	Selects a resolution to output HDMI video signals.	p.113
		<b>Aspect</b>	Selects an aspect ratio to output HDMI video signals.	p.114
	HDMI Control	<b>HDMI Control</b>	Enables/disables HDMI Control.	p.114
		<b>TV Audio Input</b>	Selects an audio input jack of the unit to be used for TV audio input.	p.114
		<b>ARC</b>	Enables/disables ARC.	p.114
		<b>Standby Sync</b>	Selects whether to use HDMI control to link the standby behavior of the TV and the unit.	p.115
	<b>HDMI Audio Output</b>	Enables/disables the audio output from a TV.	p.115	
	<b>HDCP Version</b>	Selects the version of HDCP used on the HDMI input jacks.	p.115	
<b>HDMI Standby Through</b>	Selects whether to output videos/audio (input through HDMI jacks) to the TV when the unit is in standby mode.	p.115		

Menu	Item	Function	Page	
Network	<b>Information</b>	Displays the network information on the unit.	p.116	
	<b>Network Connection</b>	Selects the network connection method.	p.116	
	<b>IP Address</b>	Configures the network parameters (such as IP address).	p.117	
	<b>Network Standby</b>	Selects whether to enable/disable the function that turns on the unit from other network devices.	p.117	
	<b>MAC Address Filter</b>	<b>Filter</b>	Sets the MAC address filter to limit access to the unit from other network devices.	p.118
		<b>MAC Address</b>	Sets the MAC address of the network device that is permitted to access the unit.	p.118
	<b>DMC Control</b>	Selects whether to allow a Digital Media Controller (DMC) to control playback.	p.118	
	<b>AirPlay Volume Interlock</b>	Enables/disables volume controls from iTunes/iPhone via AirPlay.	p.118	
	<b>Network Name</b>	Edits the network name (the unit's name on the network) displayed on other network devices.	p.119	
	<b>MusicCast Link Power Interlock</b>	Selects whether turning on the power of the master device of the MusicCast network (this unit) also turns on the power of other devices of the network.	p.119	
Bluetooth	<b>Bluetooth</b>	Enables/disables the Bluetooth functions.	p.120	
	<b>Audio Receive</b>	<b>Disconnect</b>	Terminates the Bluetooth connection between the Bluetooth device (such as smartphones) and the unit.	p.120
		<b>Bluetooth Standby</b>	Selects whether to enable/disable the function that turns on the unit from Bluetooth devices (Bluetooth standby).	p.120
Multi Zone	<b>Information</b>	Displays information about Zone2.	p.121	
	<b>Zone2</b>	<b>Volume</b>	Enables/disables volume adjustments for Zone2 output.	p.121
		<b>Max Volume</b>	Sets the Zone2 limit value of the volumes.	p.121
		<b>Initial Volume</b>	Sets the Zone2 initial volume for when the unit is turned on.	p.122
		<b>Audio Delay</b>	Adjusts the audio output timing for Zone2.	p.122
		<b>Monaural</b>	Switches between stereo and monaural for Zone2 output.	p.122
		<b>Enhancer</b>	Enables/disables Compressed Music Enhancer for Zone2 output.	p.123
		<b>Tone Control</b>	Adjusts the level of high-frequency range and low-frequency range for Zone2 output.	p.123
		<b>Extra Bass</b>	Enables/disables Extra Bass for Zone2 output.	p.123
		<b>Left / Right Balance</b>	Adjusts the volume balance for Zone2 output.	p.123
<b>Zone Rename</b>	Changes the zone name displayed on the TV screen.	p.124		
<b>Party Mode Set</b>	<b>Target : Zone2</b>	Enables/disables switching to the party mode.	p.124	

Menu	Item	Function	Page	
System	<b>Information</b>	Displays the system information on the unit.	p.125	
	<b>Language</b>	Selects an on-screen menu language.	p.125	
	<b>Audio In</b>	Combines the video jack of the selected input source with an audio jack of others.	p.126	
	<b>Input Skip</b>	Sets which input source is skipped when operating the INPUT key.	p.127	
	<b>Input Rename</b>	Changes the input source name displayed on the front display.	p.128	
	<b>Auto Play</b>	Enables/disables Auto Play function in streaming services, Internet radio, media servers (PCs/NAS), Bluetooth and USB.	p.129	
	<b>DSP Skip</b>	Sets which sound programs are skipped when operating the PROGRAM key.	p.129	
	<b>Remote Key</b>	<b>PROGRAM Key</b>	Sets the function for the PROGRAM key on the remote control.	p.129
		<b>Color Key</b>	Set the unit's functions for the RED/GREEN/YELLOW/BLUE key of the remote control.	p.130
	<b>Display Set</b>	<b>Dimmer (Front Display)</b>	Adjusts the brightness of the front display.	p.130
		<b>Volume</b>	Switches the scale of the volume display.	p.130
		<b>Short Message</b>	Selects whether to display short messages on the TV screen when the unit is operated.	p.130
		<b>Wallpaper</b>	Selects the image to be used as wallpaper on the TV screen.	p.130
	<b>Trigger Output</b>	<b>Trigger Mode</b>	Specifies the condition for the TRIGGER OUT jack to function.	p.131
		<b>Target Zone</b>	Specifies the zone with which the TRIGGER OUT jack functions are synchronized.	p.131
	<b>ECO</b>	<b>Auto Power Standby</b>	Sets the amount of time for the auto-standby function.	p.132
		<b>ECO Mode</b>	Enables/disables the eco mode (power saving mode).	p.132
	<b>Memory Guard</b>	Prevents accidental changes to the settings.	p.132	
	<b>Firmware Update</b>	Updates the firmware via the network.	p.133	

# Configuring the speaker settings

## Setting your speaker system

Select the setting according to the speakers that are connected.

### Setup menu

“Speaker” > “Power Amp Assign”

### Settings

Basic	Select this option when you use a normal speaker system (not using Zone2 speakers or a bi-amp connection).
7.1 +1Zone	Select this option when you use Zone2 speakers in addition to the 7.1 system in the main zone.
5.1.2 +1Zone	Select this option when you use Zone2 speakers in addition to the 5.1.2 system in the main zone.
5.1 BI-Amp	Select this option when you connect speakers that support bi-amp connections.

### Note

For details on the speaker system, see the following:

- “Connecting front speakers that support bi-amp connections” (p.28)
- “Connecting Zone2 speakers using the unit’s internal amplifier” (p.51)

## Setting the size of the front speakers

Selects the setting according to the size of your front speakers.

### Setup menu

“Speaker” > “Configuration” > “Front”

### Settings

	Select this option for small speakers.
Small	The subwoofer will produce front channel low-frequency components (configurable in “Crossover”).
	Select this option for large speakers.
Large	The front speakers will produce all of the front channel frequency components.

### Note

- When configuring the speaker size, as a general guideline, select “Large” if the woofer diameter of your speaker is 16 cm (6-1/4”) or larger, or “Small” if it is smaller than 16 cm (6-1/4”).
- “Front” is automatically set to “Large” when “Subwoofer” is set to “None”. For details on “Subwoofer” in the “Setup” menu, see the following:
  - “Setting the use of a subwoofer” (p.98)

## Setting the use of a center speaker and its size

Selects the setting according to the use and size of your center speaker.

### Setup menu

"Speaker" > "Configuration" > "Center"

### Settings

	Select this option for small speakers.
Small	The subwoofer or front speakers will produce center channel low-frequency components (configurable in "Crossover").
	Select this option for large speakers.
Large	The center speaker will produce all of the center channel frequency components.
	Select this option when no center speaker is connected.
None	The front speakers will produce center channel audio.

### Note

When configuring the speaker size, as a general guideline, select "Large" if the woofer diameter of your speaker is 16 cm (6.1/4") or larger, or "Small" if it is smaller than 16 cm (6.1/4").

## Setting the use of surround speakers and their size

Selects the setting according to the use and size of your surround speakers.

### Setup menu

"Speaker" > "Configuration" > "Surround"

### Settings

	Select this option for small speakers.
Small	The subwoofer or front speakers will produce surround channel low-frequency components (configurable in "Crossover").
	Select this option for large speakers.
Large	The surround speakers will produce all of the surround channel frequency components.
	Select this option when no surround speakers are connected.
None	The front speakers will produce surround channel audio. Virtual CINEMA DSP works in this case.

### Note

- When configuring the speaker size, as a general guideline, select "Large" if the woofer diameter of your speaker is 16 cm (6.1/4") or larger, or "Small" if it is smaller than 16 cm (6.1/4").
- For details on Virtual CINEMA DSP, see the following:
  - "Enjoying sound field effects without surround speakers (Virtual CINEMA DSP)" (p.46)

## Setting the layout of the surround speakers

Selects a surround speaker layout when surround speakers are used.

### Setup menu

"Speaker" > "Configuration" > "Surround" > "Layout"

### Settings

Rear	Select this option when surround speakers are placed on the rear side of the room.
Front	Select this option when surround speakers are placed on the front side of the room. Virtual CINEMA FRONT works in this case.

### Note

- This setting is not available when "Surround" is set to "None". For details, see the following:
  - "Setting the use of surround speakers and their size" (p.95)
- For details on Virtual CINEMA FRONT, see the following:
  - "Enjoying surround sound with 5 speakers placed in front (Virtual CINEMA FRONT)" (p.46)

## Setting the use of surround back speakers and their size

Selects the setting according to the use and size of your surround back speakers.

### Setup menu

"Speaker" > "Configuration" > "Surround Back"

### Settings

Small	Select this option for small speakers. The subwoofer or front speakers will produce surround back channel low-frequency components (configurable in "Crossover").
Large	Select this option for large speakers. The surround back speakers will produce all of the surround back channel frequency components.
None	Select this option when no surround back speakers are connected. The surround speakers and subwoofer (or front speakers) will produce surround back channel audio.

### Note

- When configuring the speaker size, as a general guideline, select "Large" if the woofer diameter of your speaker is 16 cm (6.1/4") or larger, or "Small" if it is smaller than 16 cm (6.1/4").
- When using surround back speakers, be sure to connect the surround back left and right speakers. Using only one surround back speaker was discontinued.
- "Surround Back" is not available when "Surround" is set to "None", or when "Layout (Surround)" is set to "Front". For details, see the following:
  - "Setting the use of surround speakers and their size" (p.95)
  - "Setting the layout of the surround speakers" (p.96)



## Setting the use of presence speakers and their size

Selects the setting according to the use and size of your presence speakers.

### Setup menu

"Speaker" > "Configuration" > "Front Presence"

### Settings

	Select this option for small speakers.
Small	The subwoofer or front speakers will produce presence channel low-frequency components (configurable in "Crossover").
	Select this option for large speakers.
Large	The presence speakers will produce all of the presence channel frequency components.
	Select this option when no presence speakers are connected.
None	The front speakers will produce presence channel audio.

### Note

When configuring the speaker size, as a general guideline, select "Large" if the woofer diameter of your speaker is 16 cm (6.1/4") or larger, or "Small" if it is smaller than 16 cm (6.1/4").

## Setting the layout of the presence speakers

Selects a presence layout when presence speakers are used. This setting facilitates the optimization of the sound field effect.

### Setup menu

"Speaker" > "Configuration" > "Front Presence" > "Layout"

### Settings

Front Height	Select this option when presence speakers are installed on the front wall.
Overhead	Select this option when presence speakers are installed to the ceiling.
Dolby Enabled SP	Select this option when using the Dolby Enabled speakers as the presence speakers.

### Note

- This setting is not available when "Front Presence" is set to "None". For details on "Front Presence" in the "Setup" menu, see the following:
  - "Setting the use of presence speakers and their size" (p.97)
- For details on the layouts of the presence speakers, see the following:
  - "Presence speaker layout" (p.162)

## Setting the crossover frequency of the low-frequency components

Sets the lower limit of the low-frequency components that can be output from a speaker whose size is set to "Small". A frequency sound lower than the specified value will be produced from the subwoofer or front speakers.

### Setup menu

"Speaker" > "Configuration" > (speaker) > "Crossover"

### Settings

40 Hz, 60 Hz, 80 Hz, 90 Hz, 100 Hz, 110 Hz, 120 Hz, 160 Hz, 200 Hz

### Note

If the volume and crossover frequency are adjustable on your subwoofer, set the volume to half and crossover frequency to maximum.

## Setting the use of a subwoofer

Selects the setting according to the use of your subwoofer.

### Setup menu

"Speaker" > "Configuration" > "Subwoofer"

### Settings

	Select this option when a subwoofer is connected.
Use	The subwoofer will produce LFE (low-frequency effect) channel audio and low-frequency components from other channels.
	Select this option when no subwoofer is connected.
None	The front speakers will produce LFE (low-frequency effect) channel audio and low-frequency components from other channels.

## Setting the phase of the subwoofer

Sets the phase of the subwoofer. When the bass sound is lacking or unclear, switch the subwoofer phase.

### Setup menu

"Speaker" > "Configuration" > "Subwoofer" > "Phase"

### Settings

Normal	Does not reverse the subwoofer phase.
Reverse	Reverses the subwoofer phase.

### Note

This setting is not available when "Subwoofer" is set to "None". For details on "Subwoofer" in the "Setup" menu, see the following:

- "Setting the use of a subwoofer" (p.98)

## Setting the distance between each speaker and the listening position

Sets the distance between each speaker and the listening position so that sounds from the speakers reach the listening position at the same time.

### Setup menu

"Speaker" > "Distance"

### Choices

Front L, Front R, Center, Surround L, Surround R, Surround Back L, Surround Back R, Presence L, Presence R, Subwoofer

### Setting range

0.30 m to 24.00 m (1.0 ft to 80.0 ft), 0.05 m (0.2 ft) increments

### Note

Select the unit of distance from "Meter" or "Feet" in "Unit".

## Adjusting the volume of each speaker

Adjusts the volume of each speaker to suit your listening position.

### Setup menu

"Speaker" > "Level"

### Choices

Front L, Front R, Center, Surround L, Surround R, Surround Back L, Surround Back R, Presence L, Presence R, Subwoofer

### Setting range

-10.0 dB to +10.0 dB (0.5 dB increments)

### Note

Test tone output helps you to adjust the speaker balance while confirming its effect. For details, see the following:

- "Outputting test tones" (p.100)

## Setting the equalizer

Selects the type of equalizer to be used and adjusts the tone.

### Setup menu

"Speaker" > "Parametric EQ" > "Parametric EQ"

### Settings

Manual	Select this option when you want to adjust the equalizer manually.
YPAO:Flat	Adjusts individual speakers to achieve the same characteristics.
YPAO:Front	Adjusts individual speakers to achieve the same characteristics as the front speakers.
YPAO:Natural	Adjusts all speakers to achieve a natural sound.
Through	Does not use the equalizer.

### Note

"YPAO:Flat", "YPAO:Front", and "YPAO:Natural" are available only when the YPAO measurement results have already been saved. Press ENTER again to view the YPAO measurement results. For details on the YPAO, see the following:

- "Optimizing the speaker settings automatically (YPAO)" (p.38)

### When selecting "Manual"

- 1** Set "Parametric EQ" to "Manual" and press ENTER.
- 2** Press ENTER again to enter the edit screen.
- 3** Use the cursor keys to select a speaker and press ENTER.

### Note

- To restore the default settings for all speakers, select "PEQ Data Clear" and then "OK".
- To copy the parametric equalizer values acquired with the YPAO measurement results to the "Manual" fields for fine adjustment, select "PEQ Data Copy" and then an equalizer type.

#### 4 Use the cursor keys to select a center frequency from the 7 preset bands (4 for subwoofer).

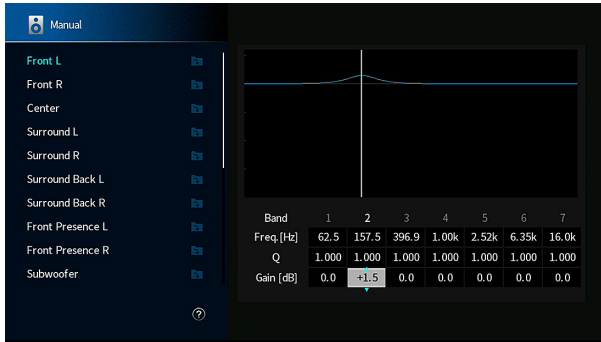

#### 5 To fine-adjust the center frequency, Q factor (bandwidth) or gain, use the cursor keys to select an item.

Freq.: Use the cursor keys to adjust the center frequency of the selected band.

Q: Use the cursor keys to adjust the Q factor (bandwidth) of the selected band.

Gain: Use the cursor keys to adjust the gain of the selected band.

##### Setting range

Center frequency: 15.6 Hz to 16.0 kHz (15.6 Hz to 250.0 Hz for subwoofer)

Q factor: 0.500 to 10.080

Gain: -20.0 dB to +6.0 dB

#### 6 Press SETUP.

This completes the settings.

## Outputting test tones

Enables/disables the test tone output. Test tone output helps you to adjust the speaker balance or equalizer while confirming its effect.

### Setup menu

"Speaker" > "Test Tone"

### Settings

Off	Does not output test tones.
On	Outputs test tones automatically when you adjust the speaker balance or equalizer.

## Reloading the previous YPAO adjustments

When the speaker settings you have configured manually are not suitable, you can discard the manual settings and reload the previous YPAO adjustments.

### Setup menu

"Speaker" > "YPAO Result"

**1 Use the cursor keys to select "Setup Reload" and press ENTER.**

**2 Press SETUP.**

This completes the settings.

### Note

You can check the previous YPAO adjustments ("Wiring", "Size", "Distance", and "Level") in "YPAO Result".

# Configuring the sound settings

## Checking the current audio signal information

Displays information about the current audio signal.

### Setup menu

“Sound” > “Information”

Input	Format	Audio format of the input signal
	Channel	The number of source channels in the input signal (front/surround/LFE) For example, “5.1 (3/2/0.1)” means 5.1ch in total (3 front channels, 2 surround channels, and LFE).
		(When DTS:X content is played back) For example, “7.1.4” denotes “standard 7.1-channel plus 4 for overhead speaker channels”.
	Sampling	The number of samples per second of the input digital signal
Dialogue	The dialogue normalization level of the input bitstream signal	
Output	Channel	The number of signal output channels (for example, “5.1.2” denotes “standard 5.1-channel plus 2 for overhead speaker channels”) and the speaker terminals from which signals are output

### Note

- Even when the unit is set to output bitstream signals directly, the signal may be converted depending on the specifications and settings of the playback device.
- Use the left/right cursor keys to display other informations in the “Setup” menu.

## Enabling Lipsync adjustment

Enables/disables the “Lipsync” adjustment configured in “Auto/Manual Select” in the “Setup” menu.

### Note

For details on “Auto/Manual Select” in the “Setup” menu, see the following:

- “Setting the adjustment method of the Lipsync function” (p.102)

### Setup menu

“Sound” > “Lipsync” > “Delay Enable”

### Settings

Disable	Disables the “Lipsync” adjustment.
Enable	Enables the “Lipsync” adjustment.

### Note

This setting is applied separately to each input source.

## Setting the adjustment method of the Lipsync function

---

Selects the method for adjusting the delay between video and audio output.

### Setup menu

“Sound” > “Lipsync” > “Auto/Manual Select”

### Settings

Manual	Select this option when you want to adjust the delay between video and audio output manually. Adjust the audio output timing in “Adjustment”.
Auto	Adjusts the delay between video and audio output automatically when a TV that supports an automatic lipsync function is connected to the unit via HDMI. If necessary, you can fine-adjust the audio output timing in “Adjustment”.

### Note

- You can enable/disable the Lipsync function by input sources in “Delay Enable” in the “Setup” menu. For details, see the following:
  - “Enabling Lipsync adjustment” (p.101)
- For details on “Adjustment” in the “Setup” menu, see the following:
  - “Adjusting the delay of the Lipsync function” (p.102)

## Adjusting the delay of the Lipsync function

---

Adjusts the delay between video and audio output manually when “Auto/Manual Select” is set to “Manual”. You can fine-adjust the audio output timing when “Auto/Manual Select” is set to “Auto”.

### Setup menu

“Sound” > “Lipsync” > “Adjustment”

### Setting range

0 ms to 500 ms (1 ms increments)

### Note

For details on “Auto/Manual Select” in the “Setup” menu, see the following:

- “Setting the adjustment method of the Lipsync function” (p.102)

## Selecting sound programs

Selects the sound program to change the settings of the sound program.

### Note

You can select a sound program by pressing PROGRAM.

### Setup menu

“Sound” > “DSP Parameter”

## MUSIC

<b>Hall in Munich</b>	This program simulates a Munich concert hall with approximately 2,500 seats that uses stylish wood for the interior finishing. Fine, beautiful reverberations spread richly, creating a calming atmosphere. The listener's virtual seat is at the center left of the arena.
<b>Hall in Vienna</b>	This program simulates a 1700-seat, middle-sized concert hall with a shoebox shape that is traditional in Vienna. Pillars and ornate carvings create extremely complex reverberations from all around the audience, producing a very full, rich sound.
<b>Chamber</b>	This program creates a relatively wide space with a high ceiling, like an audience hall in a palace. It offers pleasant reverberations that are suitable for courtly music and chamber music.
<b>Cellar Club</b>	This program simulates an intimate concert venue with a low ceiling and homey atmosphere. A realistic, live sound field delivers powerful sounds that make you feel as if you are sitting in the front row in front of a small stage.
<b>The Roxy Theatre</b>	This program creates the sound field of a 460-seat rock music concert venue in Los Angeles. The listener's virtual seat is at the center left of the hall.
<b>The Bottom Line</b>	This program creates the sound field at stage front in The Bottom Line, a famous New York jazz club once. The floor can seat 300 people to the left and right in a sound field offering real and vibrant sound.
<b>2ch Stereo</b>	Use this program to mix down multichannel sources to 2 channels. When multichannel signals are input, they are down mixed to 2 channels and output from the front speakers (this program does not utilize CINEMA DSP).
<b>7ch Stereo</b>	Use this program to output sound from all speakers. When you play back multichannel sources, the unit mixes down the source to 2 channels, and then outputs the sound from all speakers. This program creates a larger sound field and is ideal for background music at parties.

## MOVIE

<b>Sports</b>	This program allows listeners to enjoy the rich vividness of sport broadcasts and light entertainment programs. In sports broadcasts, the commentators' voices are positioned clearly at the center, while the atmosphere inside the stadium is realistically conveyed by the peripheral delivery of the sounds of the fans in a suitable space.
<b>Action Game</b>	This program is suitable for action games, such as car racing and fighting games. The reality of, and emphasis on, various effects makes the player feel like they are right in the middle of the action, allowing for greater concentration. Use this program in combination with Compressed Music Enhancer for a more dynamic and strong sound field.
<b>Roleplaying Game</b>	This program is suitable for role-playing and adventure games. This program adds depth to the sound field for natural and realistic reproduction of background music, special effects, and dialogue from a wide variety of scenes. Use this program in combination with Compressed Music Enhancer for a clearer and more spatial sound field.
<b>Music Video</b>	This program allows you to enjoy videos of pop, rock, and jazz concerts, as if you were there yourself. Immerse yourself in the hot concert atmosphere thanks to the vividness of the singers and solos on stage, a presence sound field that emphasizes the beat of rhythm instruments, and a surround sound field that reproduces the space of a big live hall.
<b>Standard</b>	This program creates a sound field that emphasizes the surround feeling without disturbing the original acoustic positioning of multichannel audio. Its design is based on the concept of the ideal movie theater, in which the audience is surrounded by beautiful reverberations from the left, right, and rear.
<b>Spectacle</b>	This program delivers the scale and grandeur of spectacular movie productions. It delivers an expansive sound space to match the cinemascope wide-screen, and boasts a broad dynamic range, providing everything from small delicate sounds to powerful loud booms.
<b>Sci-Fi</b>	This program clearly reproduces the finely elaborated sound design of the latest Sci-Fi and SFX movies. You can enjoy a variety of cinematographically created virtual spaces reproduced with clear separation between dialogue, sound effects, and background music.
<b>Adventure</b>	This program is ideal for reproducing the sound design of action and adventure movies precisely. The sound field restrains reverberations, but puts emphasis on reproducing a sensation of expansiveness on both sides, powerful space expanded widely to the left and right. The restrained depth creates a clear and powerful space, while also maintaining the articulation of the sounds and the separation of the channels.
<b>Drama</b>	This program features stable reverberations that match a wide range of movie genres, from serious dramas to musicals and comedies. The reverberations are modest, but suitably stereophonic. The sound effects and background music are reproduced with a gentle echo that does not impinge on the articulation of the dialogue. You'll never get tired listening for long periods.

This program reproduces monaural video sources, such as classic movies, in an atmosphere of a good old movie theater. The program creates a pleasant space with depth, by adding breadth and the appropriate reverberation to the original audio.

## Adjusting the sound field effect level

Adjusts the sound field effect level. Higher to enhance the sound field effect, and lower to reduce it.

### Setup menu

"Sound" > "DSP Parameter" > (sound program) > "DSP Level"

### Setting range

-6 dB to +3 dB

### Note

- Available items vary depending on the selected sound program.
- To restore the default settings for the selected sound program, select "Reset".

## Adjusting the delay between the direct sound and presence sound field generation

Adjusts the delay between the direct sound and presence sound field generation. Higher to enhance the delay effect, and lower to reduce it.

### Setup menu

"Sound" > "DSP Parameter" > (sound program) > "Initial Delay"

### Setting range

1 ms to 99 ms

### Note

- Available items vary depending on the selected sound program.
- To restore the default settings for the selected sound program, select "Reset".

## Adjusting the broadening effect of the presence sound field

Adjusts the broadening effect of the presence sound field.

### Setup menu

"Sound" > "DSP Parameter" > (sound program) > "Room Size"

### Setting range

0.1 to 2.0 (higher to enhance the broadening effect)

### Note

- Available items vary depending on the selected sound program.
- To restore the default settings for the selected sound program, select "Reset".



## Adjusting the loss of the presence sound field

---

Adjusts the loss of the presence sound field.

### Setup menu

“Sound” > “DSP Parameter” > (sound program) > “Liveness”

### Setting range

0 to 10 (higher to enhance the reflectivity)

### Note

- Available items vary depending on the selected sound program.
- To restore the default settings for the selected sound program, select “Reset”.

## Adjusting the decay time of the rear reverberant sound

---

Adjusts the decay time of the rear reverberant sound. Higher to enrich the reverberant sound and lower to have clear sound.

### Setup menu

“Sound” > “DSP Parameter” > (sound program) > “Reverb Time”

### Setting range

1.0 s to 5.0 s

### Note

- Available items vary depending on the selected sound program.
- To restore the default settings for the selected sound program, select “Reset”.

## Adjusting the delay between the direct sound and reverberant sound generation

---

Adjusts the delay between the direct sound and reverberant sound generation. Higher to enhance the delay effect, and lower to reduce it.

### Setup menu

“Sound” > “DSP Parameter” > (sound program) > “Reverb Delay”

### Setting range

0 ms to 250 ms

### Note

- Available items vary depending on the selected sound program.
- To restore the default settings for the selected sound program, select “Reset”.

## Adjusting the volume of the reverberant sound

---

Adjusts the volume of the reverberant sound. Higher to strengthen the reverberant sound, and lower to weaken it.

### Setup menu

“Sound” > “DSP Parameter” > (sound program) > “Reverb Level”

### Setting range

0 % to 100 %

### Note

- Available items vary depending on the selected sound program.
- To restore the default settings for the selected sound program, select “Reset”.

## Adjusting the delay between the direct sound and surround sound field generation

---

Adjusts the delay between the direct sound and surround sound field generation. Higher to enhance the delay effect, and lower to reduce it.

### Setup menu

"Sound" > "DSP Parameter" > (sound program) > "Surround Initial Delay"

### Setting range

1 ms to 49 ms

### Note

- Available items vary depending on the selected sound program.
- To restore the default settings for the selected sound program, select "Reset".

## Adjusting the broadening effect of the surround sound field

---

Adjusts the broadening effect of the surround sound field.

### Setup menu

"Sound" > "DSP Parameter" > (sound program) > "Surround Room Size"

### Setting range

0.1 to 2.0 (higher to enhance the broadening effect)

### Note

- Available items vary depending on the selected sound program.
- To restore the default settings for the selected sound program, select "Reset".

## Adjusting the loss of the surround sound field

---

Adjusts the loss of the surround sound field.

### Setup menu

"Sound" > "DSP Parameter" > (sound program) > "Surround Liveness"

### Setting range

0 to 10 (higher to enhance the reflectivity)

### Note

- Available items vary depending on the selected sound program.
- To restore the default settings for the selected sound program, select "Reset".

## Adjusting the delay between the direct sound and surround back sound field generation

---

Adjusts the delay between the direct sound and surround back sound field generation. Higher to enhance the delay effect, and lower to reduce it.

### Setup menu

"Sound" > "DSP Parameter" > (sound program) > "Surround Back Initial Delay"

### Setting range

1 ms to 49 ms

### Note

- Available items vary depending on the selected sound program.
- To restore the default settings for the selected sound program, select "Reset".

## Adjusting the broadening effect of the surround back sound field

Adjusts the broadening effect of the surround back sound field.

### Setup menu

“Sound” > “DSP Parameter” > (sound program) > “Surround Back Room Size”

### Setting range

0.1 to 2.0 (higher to enhance the broadening effect)

### Note

- Available items vary depending on the selected sound program.
- To restore the default settings for the selected sound program, select “Reset”.

## Adjusting the loss of the surround back sound field

Adjusts the loss of the surround back sound field.

### Setup menu

“Sound” > “DSP Parameter” > (sound program) > “Surround Back Liveness”

### Setting range

0 to 10 (higher to enhance the reflectivity)

### Note

- Available items vary depending on the selected sound program.
- To restore the default settings for the selected sound program, select “Reset”.

## Selecting the surround decoder used in the program

Selects a surround decoder to be used in combination with the selected sound program.

### Setup menu

“Sound” > “Surround Decoder” > “Decode Type”

## Settings

<b>Auto</b>	Uses the decoder automatically selected by input source. The DTS Neural:X decoder is selected for DTS sources and the Dolby Surround decoder is selected for other sources.
<b>Dsur</b>	Dolby Surround decoder. Expands the sound using a method optimized for the layout of the installed speakers. It produces the extended surround sound optimized for your speaker system. A real acoustic space (including overhead) will be created especially when object-based audio (such as Dolby Atmos content) is played.
<b>Neural:X</b>	DTS Neural:X decoder. Expands the sound using a method optimized for the layout of the installed speakers. It produces the extended surround sound optimized for your speaker system. A real acoustic space (including overhead) will be created especially when object-based audio (such as DTS:X content) is played.
<b>Neo:6 Cinema</b>	Uses the DTS Neo:6 decoder (or DTS-ES Matrix decoder) suitable for movies. Sounds will be output from the surround/surround back speakers.
<b>Neo:6 Music</b>	Uses the DTS Neo:6 decoder (or DTS-ES Matrix decoder) suitable for music. Sounds will be output from the surround/surround back speakers.

### Note

- For details on each decoder, see the following:
  - “Glossary of audio decoding format” (p.164)
- You can adjust the surround decoder parameters in “Surround Decoder” in the “Setup” menu. For details, see the following:
  - “Adjusting the center localization (broadening effect) of the front sound field” (p.108)
  - “Setting the use of Center Spread” (p.108)
- The selected surround decoder may not work for some input sources.
- We recommend Dolby Surround while network streaming is Dolby contents.
- The Neural:X decoder does not work for Dolby Digital Plus or Dolby TrueHD signals. Select “Auto” or “Dsur” for these signals.
- When the Dolby Surround decoder or the Neural:X decoder is selected, virtual surround processing (such as Virtual CINEMA FRONT) does not work. For details, see the following:
  - “Enjoying sound field effects without surround speakers (Virtual CINEMA DSP)” (p.46)
  - “Enjoying surround sound with 5 speakers placed in front (Virtual CINEMA FRONT)” (p.46)

## Setting the use of Center Spread

---

Selects whether to spread the center channel signals to left and right when a 2-channel source is played. This setting is effective when "Dsur" is selected.

### Setup menu

"Sound" > "Surround Decoder" > "Center Spread"

### Settings

Off	Disables Center Spread.
On	Enables Center Spread.

### Note

- If you feel the center sound is too strong, set this function to "On".
- For details on the surround decoder, see the following:
  - "Selecting the surround decoder used in the program" (p.107)

## Adjusting the center localization (broadening effect) of the front sound field

---

Adjusts the center localization (broadening effect) of the front sound field. Adjust this higher to strengthen the center localization (less broadening effect) or lower to weaken it (more broadening effect). This setting is effective when "Neo:6 Music" is selected.

### Setup menu

"Sound" > "Surround Decoder" > "Center Image"

### Setting range

0.0 to 1.0

### Note

For details on the surround decoder, see the following:

- "Selecting the surround decoder used in the program" (p.107)

## Adjusting the entire volume for "7ch Stereo"

---

Adjusts the entire volume. This setting is effective when "7ch Stereo" is selected.

### Setup menu

"Sound" > "7ch Stereo" > "Level"

### Setting range

-5 to +5

## Adjusting the front and rear volume balance for "7ch Stereo"

---

Adjusts the front and rear volume balance. Higher to enhance the front side, and lower to enhance the rear side. This setting is effective when "7ch Stereo" is selected.

### Setup menu

"Sound" > "7ch Stereo" > "Front / Rear Balance"

### Setting range

-5 to +5

## Adjusting the left and right volume balance for "7ch Stereo"

---

Adjusts the left and right volume balance. Higher to enhance the right side, and lower to enhance the left side. This setting is effective when "7ch Stereo" is selected.

### Setup menu

"Sound" > "7ch Stereo" > "Left / Right Balance"

### Setting range

-5 to +5

## Adjusting the height volume balance using the presence speakers for “7ch Stereo”

Adjusts the height volume balance using the presence speakers. Higher to enhance the upside, and lower to enhance the downside. This setting is effective when “7ch Stereo” is selected.

### Setup menu

“Sound” > “7ch Stereo” > “Height Balance”

### Setting range

0 to 10

### Note

The presence speakers do not produce sounds when “Height Balance” is set to “0”.

## Setting the use of Monaural Mix for “7ch Stereo”

Enables/disables monaural sound output. This setting is effective when “7ch Stereo” is selected.

### Setup menu

“Sound” > “7ch Stereo” > “Monaural Mix”

### Settings

Off	Disables monaural sound output.
On	Enables monaural sound output.

## Setting the dynamic range adjustment method

Selects the dynamic range adjustment method for bitstream audio (Dolby Digital and DTS signals) playback.

### Setup menu

“Sound” > “Dynamic Range”

### Settings

Maximum	Produces audio without adjusting the dynamic range.
Standard	Optimizes the dynamic range for regular home use.
Minimum/Auto	Sets the dynamic range for clear sound even at night or at low volumes. When playing back Dolby TrueHD signals, the dynamic range is automatically adjusted based on the input signal information.

## Setting the limit value of the volume

Sets the limit value of the volume adjusted by using such as VOLUME keys on the remote control.

### Setup menu

“Sound” > “Volume” > “Max Volume”

### Setting range

-60.0 dB to +15.0 dB (5.0 dB increments), +16.5 dB [20.5 to 95.5 (5.0 increments), 97.0]

### Note

For details on the scale of the volume display (dB unit or numeric value), see the following:

- “Setting the scale of the volume display” (p.130)

## Setting the initial volume for when the unit is turned on

Sets the initial volume when the unit is turned on.

### Setup menu

“Sound” > “Volume” > “Initial Volume”

### Settings

Off		Sets the level to the volume level of the unit when it last entered standby mode.
	Mute	Sets the unit to mute the audio output.
On	-80.0 dB to +16.5 dB (0.5 dB increments) [0.5 to 97.0 (0.5 increments)]	Sets the level to the specified volume level.

### Note

- This setting works only when the volume level is set lower than “Max Volume”. For details on “Max Volume” in the “Setup” menu, see the following:
  - “Setting the limit value of the volume” (p.109)
- For details on the scale of the volume display (dB unit or numeric value), see the following:
  - “Setting the scale of the volume display” (p.130)

## Adjusting the CINEMA DSP 3D effect level automatically

Selects whether to automatically adjust the CINEMA DSP 3D effect level when the volume is adjusted.

### Setup menu

“Sound” > “Adaptive DSP Level”

### Settings

Off	Does not adjust the effect level automatically.
On	Adjusts the effect level automatically.

## Setting Virtual Surround Back Speaker (VSBS)

Selects whether to create Virtual Surround Back Speaker (VSBS) using the surround speakers.

When VSBS is enabled, the unit creates VSBS when no surround back speakers are connected.

### Setup menu

“Sound” > “Virtual Speaker” > “VSBS”

### Settings

Off	Disables Virtual Surround Back Speaker (VSBS).
On	Enables Virtual Surround Back Speaker (VSBS).

### Note

- VSBS is effective only when 6.1/7.1-channel content is played back.
- VSBS, that is working with CINEMA DSP 3D, is not available when the straight decode mode or the direct playback mode is enabled.

# Configuring the scene settings

## Selecting items to be included as the scene assignments

Selects items to be included as the scene assignments. You can also view the settings currently assigned to the selected scene.

### Note

The scene assignments can include radio stations, or the content on a selected USB storage device, Bluetooth device, and network device.

### Setup menu

“Scene” > “Scene Setting”

- 1 Use the cursor keys to select the SCENE name and press ENTER.
- 2 To include items as the scene assignments, use the cursor keys to select an item and press ENTER to check the box (or uncheck the box to exclude).

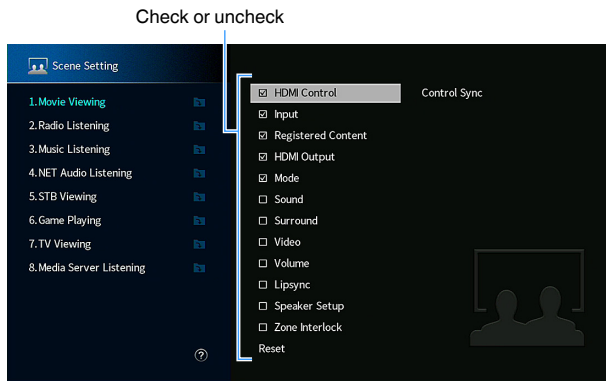

### Choices

HDMI Control	Control Sync (HDMI Control (p.114))
Input	Input (p.56)
Registered Content	[Input sources: TUNER, (network sources), SERVER, NET RADIO, Bluetooth, USB] Station, Music Content [Input sources: others] ---
HDMI Output	HDMI Output (p.57)
Mode	DSP Program (p.45), Enhancer (p.82)
Sound	Tone Control (p.79), YPAO Volume (p.80), Adaptive DRC (p.80), Extra Bass (p.83)
Surround	Dialogue Lift (p.81), Dialogue Level (p.81), Subwoofer Trim (p.82)
Video	Video Mode (p.113)
Volume	Master Volume (p.56)
Lipsync	Lipsync (p.102)
Speaker Setup	PEQ Select (p.99)
Zone Interlock	Power (p.54), Input (p.54), Volume (p.121)

### Note

To restore the default settings for the selected scene, select “Reset” and press ENTER.

## Renaming the SCENE name

Changes the SCENE name displayed on the front display or on the TV.

### Setup menu

“Scene” > “Scene Rename”

**1** Use the cursor keys to select the SCENE name and press ENTER to enter the name edit screen.

**2** Use the cursor keys and ENTER to rename.

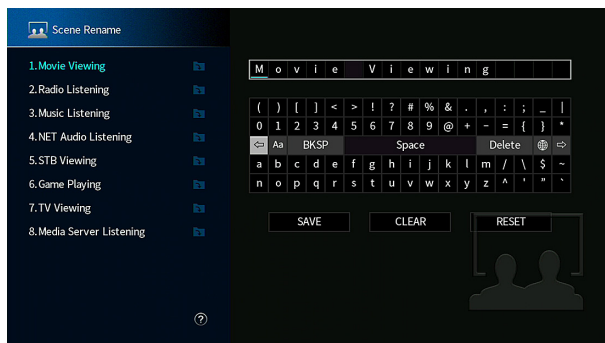

### Note

- To clear the entry, select “CLEAR”.
- To restore the default name, select “RESET”.

**3** Use the cursor keys to select “SAVE” and press ENTER.

**4** Press SETUP.

This completes the settings.



## Configuring the video/HDMI settings

### Checking the current video and HDMI signal information

Displays information about the current video signal and the TVs connected to the HDMI OUT jacks.

#### Setup menu

"Video/HDMI" > "Information"

HDMI Signal	Presence or absence of HDMI signal input/output
HDMI Resolution	Resolutions of input signal (analog or HDMI) and output signal (HDMI)
Video Resolution	Resolutions supported by the TV

#### Note

Use the left/right cursor keys to display other informations in the "Setup" menu.

### Setting the use of the video signal processing

Enables/disables the video signal processing (resolution and aspect ratio).

#### Setup menu

"Video/HDMI" > "Video Mode" > "Video Mode"

#### Settings

Direct	Disables the video signal processing.
Processing	Enables the video signal processing. Configure the settings in "Resolution" and "Aspect".

#### Note

- When "Video Mode" is set to "Direct", the unit transmits video signals with the least circuitry in order to reduce video output delay.
- When "Video Mode" is set to "Processing" and the resolution is being converted, short messages are not displayed on the TV screen.

### Setting a resolution to output HDMI video signals

Selects a resolution to output HDMI video signals when "Video Mode" is set to "Processing".

#### Note

For details on "Video Mode" in the "Setup" menu, see the following:

- "Setting the use of the video signal processing" (p.113)

#### Setup menu

"Video/HDMI" > "Video Mode" > "Resolution"

#### Settings

Through	Does not convert the resolution.
Auto	Selects a resolution automatically in accordance with TV resolution.
480p/576p, 720p, 1080i, 1080p, 4K	Output video signals with a selected resolution. (Only the resolutions supported by your TV are selectable.)

#### Note

If you need to select a resolution that is not supported by your TV, set "MON.CHK" in the "ADVANCED SETUP" menu to "SKIP" and try again. (Note that the output video may not be displayed on your TV normally.) For details, see the following:

- "Removing the limitation on HDMI video output (MON.CHK)" (p.136)

## Setting an aspect ratio to output HDMI video signals

Selects an aspect ratio to output HDMI video signals when “Video Mode” is set to “Processing”.

### Note

For details on “Video Mode” in the “Setup” menu, see the following:

- “Setting the use of the video signal processing” (p.113)

### Setup menu

“Video/HDMI” > “Video Mode” > “Aspect”

### Settings

Through	Does not convert the aspect ratio.
16:9 Normal	Outputs 4:3 video signals to a 16:9 TV with black bands on either side of the screen.

### Note

This setting functions only when 480i/576i or 480p/576p signals are converted into 720p, 1080i, 1080p, or 2160p (4K) signals.

## Setting the use of HDMI Control

Enables/disables HDMI Control. HDMI Control allows you to operate external devices via HDMI.

### Setup menu

“Video/HDMI” > “HDMI Control” > “HDMI Control”

### Settings

Off	Disables HDMI Control.
On	Enables HDMI Control. Configure the settings in “TV Audio Input”, “ARC” and “Standby Sync”.

### Note

To use HDMI control, you need to perform the HDMI Control link setup after connecting HDMI Control-compatible devices. For details, see the following:

- “HDMI Control and synchronized operations” (p.170)

## Setting the audio jack used for TV audio input

Selects an audio input jack of the unit to be used for TV audio input when “HDMI Control” is set to “On”. The unit’s input source automatically switches to TV audio when the TV input is switched to its built-in tuner.

### Note

For details on “HDMI Control” in the “Setup” menu, see the following:

- “Setting the use of HDMI Control” (p.114)

### Setup menu

“Video/HDMI” > “HDMI Control” > “TV Audio Input”

### Settings

AV 1–2, AUDIO 1–5

### Note

When using ARC to input TV audio to the unit, the input jacks selected here will be used for TV Audio Input.

## Setting the use of ARC

Select whether to output TV audio to the speakers connected to the unit when “HDMI Control” is set to “On”.

### Note

For details on “HDMI Control” in the “Setup” menu, see the following:

- “Setting the use of HDMI Control” (p.114)

### Setup menu

“Video/HDMI” > “HDMI Control” > “ARC”

### Settings

Off	Disables ARC.
On	Enables ARC.

### Note

You do not need to change this setting normally. In case noises are produced from the speakers connected to the unit because TV audio signals input to the unit via ARC are not supported by the unit, set “ARC” to “Off” and use the TV’s speakers.

## Linking the standby modes of the unit and the TV

Select whether to use HDMI control to link the unit's standby mode to the TV's power when "HDMI Control" is set to "On".

### Note

For details on "HDMI Control" in the "Setup" menu, see the following:

- "Setting the use of HDMI Control" (p.114)

### Setup menu

"Video/HDMI" > "HDMI Control" > "Standby Sync"

### Settings

Off	Does not set the unit to standby mode when the TV is turned off.
On	Sets the unit to standby mode when the TV is turned off.
Auto	Sets the unit to standby mode when the TV is turned off only when the unit is receiving TV audio or HDMI signals.

## Setting the output of HDMI audio from the TV speaker

Enables/disables audio output from a TV connected to the HDMI OUT jack.

### Note

- The "HDMI OUT1" setting is available only when "HDMI Control" is set to "Off".
- For details on "HDMI Control" in the "Setup" menu, see the following:
  - "Setting the use of HDMI Control" (p.114)

### Setup menu

"Video/HDMI" > "HDMI Audio Output" > "HDMI OUT1"/"HDMI OUT2"

### Settings

Off	Disables audio output from the TV.
On	Enables audio output from the TV.

## Setting the version of HDCP used on the HDMI input jacks

Selects the HDCP version of the HDMI input jacks for watching 4K video content.

### Setup menu

"Video/HDMI" > "HDCP Version"

### Input sources

HDMI 1–5

### Settings

Auto	Automatically sets the version of HDCP according to content.
1.4	Sets the version of HDCP to always be 1.4.

## Setting the use of HDMI Standby Through

Select whether to output video/audio (input through HDMI jacks) to the TV when the unit is in standby mode.

### Note

If this function is set to "On" or "Auto", you can use the input selection keys (HDMI 1–5) to select an HDMI input even when the unit is in standby mode (the standby indicator on the unit blinks).

### Setup menu

"Video/HDMI" > "HDMI Standby Through"

### Settings

Off	Does not output video/audio to the TV.
Auto	Automatically selects whether to output video/audio depending on the status of the connected device.
On	Outputs video/audio to the TV. (The unit consumes more power than when "Off" or "Auto" is selected.)

### Note

- "Off" is not selectable when "HDMI Control" is set to "On".
- For details on "HDMI Control" in the "Setup" menu, see the following:
  - "Setting the use of HDMI Control" (p.114)

# Configuring the network settings

## Checking the network information on the unit

Displays the network information on the unit.

### Setup menu

“Network” > “Information”

IP Address	IP address
Subnet Mask	Subnet mask
Default Gateway	The IP address of the default gateway
DNS Server (P)	The IP address of the primary DNS server
DNS Server (S)	The IP address of the secondary DNS server
MAC Address (Ethernet)	MAC address
MAC Address (Wi-Fi)	
Network Name	Network name (the unit's name on the network)
MusicCast Network	The status of the MusicCast network connection.
Wired/Wireless	The status of the wired or wireless connection
SSID	(When using wireless [Wi-Fi] network connection) The SSID of the wireless network

### Note

Use the left/right cursor keys to display other informations in the “Setup” menu.

## Setting the network connection method (Wired/Wireless)

Selects the network connection method.

### Setup menu

“Network” > “Network Connection”

### Choices

Wired	Select this option when you want to connect the unit to a network with a commercially-available network cable.
Wireless(Wi-Fi)	Select this option when you want to connect the unit to a network via the wireless router (access point).

### Note

For details on the network connection, see the following:

- “Preparing for connecting to a network” (p.33)

## Setting the network parameters automatically (DHCP)

Set the network parameters (such as IP address, Subnet Mask, and Default Gateway) automatically using a DHCP server.

### Setup menu

“Network” > “IP Address” > “DHCP”

### Settings

Off	Does not use a DHCP server. Configure the network parameters manually.
On	Uses a DHCP server to automatically obtain the unit's network parameters (such as IP address).

## Setting the network parameters manually

Set the network parameters (such as IP address, Subnet Mask, and Default Gateway) manually.

### Setup menu

"Network" > "IP Address"

- 1 Set "DHCP" to "Off".
- 2 Use the cursor keys to select "IP Address" and press ENTER.
- 3 Use the cursor keys to select a parameter type and press ENTER.

IP Address	Specifies an IP address.
Subnet Mask	Specifies a subnet mask.
Default Gateway	Specifies the IP address of the default gateway.
DNS Server (P)	Specifies the IP address of the primary DNS server.
DNS Server (S)	Specifies the IP address of the secondary DNS server.

- 4 Use the cursor keys to move the edit position and to select a value.
- 5 To confirm the setting, press ENTER.
- 6 To set another parameter, repeat steps 3 to 5.
- 7 Press SETUP.

This completes the settings.

## Setting the use of the Network Standby function

Selects whether the unit can be turned on from other network devices (network standby).

### Setup menu

"Network" > "Network Standby"

### Settings

Off	Disables the network standby function.
On	Enables the network standby function. (The unit consumes more power than when "Off" is selected.)
Auto	Enables the network standby function. (If "Network Connection" is set to "Wired", the unit is set to the power saving mode when the network cable is disconnected.)

### Note

If you set "Network Standby" to "Off", "Bluetooth Standby" will be disabled.



With an advanced energy saving design, this product achieves a low power consumption of not more than two watts when in Network Standby mode.

## Setting the MAC address filter

Sets the MAC address filter to limit access to the unit from other network devices.

### Note

- Operation of the AirPlay function or the DMC is not limited by this setting.
- You can specify up to 10 network devices that are permitted to access the unit. For details, see the following:
  - “Setting the MAC address” (p.118)

### Setup menu

“Network” > “MAC Address Filter” > “Filter”

### Settings

Off	Disables the MAC address filter.
On	Enables the MAC address filter. Specify the MAC addresses of the network devices that will be permitted access to the unit.

## Setting the MAC address

Sets the MAC address of the network device that is permitted to access the unit. You can specify up to 10 network devices.

### Setup menu

“Network” > “MAC Address Filter” > “MAC Address”

- 1 Use the cursor keys to select an MAC address number and press ENTER.**
- 2 Use the cursor keys to move the edit position and to select a value.**
- 3 To confirm the setting, press ENTER.**
- 4 To specify another MAC address, repeat steps 1 to 3.**
- 5 Press SETUP.**

This completes the settings.

## Setting the use of a Digital Media Controller

Selects whether to allow a Digital Media Controller (DMC) to control playback. A Digital Media Controller (DMC) is a device that can control other network devices through the network. When this function is enabled, you can control playback of the unit from DMCs (such as Windows Media Player 12) on the same network.

### Setup menu

“Network” > “DMC Control”

### Settings

Disable	Does not allow DMCs to control playback.
Enable	Allows DMCs to control playback.

## Setting the use of volume control via AirPlay

Enables/disables volume control from iTunes/iPhone via AirPlay. When other than “Off” is set, you can adjust the unit's volume from the iTunes/iPhone during playback.

### Setup menu

“Network” > “AirPlay Volume Interlock”

### Settings

Off	Disables volume control from iTunes/iPhone.
Limited	Enables volume control from iTunes/iPhone within the limited range (-80 dB to -20 dB and mute).
Full	Enables volume control from iTunes/iPhone in the full range (-80 dB to +16.5 dB and mute).

## Setting the network name of the unit

---

Edits the network name (the unit's name on the network) displayed on other network devices.

### Setup menu

"Network" > "Network Name"

- 1 Press ENTER to enter the name edit screen.**
- 2 Use the cursor keys and ENTER to edit the name.**

#### Note

- To clear the entry, select "CLEAR".
- To restore the default name, select "RESET".

- 3 Use the cursor keys to select "SAVE" and press ENTER.**

- 4 Press SETUP.**

This completes the settings.

## Setting the power interlock from the unit to MusicCast compatible devices

---

Selects whether turning on the power of the master device of the MusicCast network (this unit) also turns on the power of other devices of the network.

### Setup menu

"Network" > "MusicCast Link Power Interlock"

### Settings

---

Off	Disables the power interlock from the unit (MusicCast master).
On	Enables the power interlock from the unit (MusicCast master).

---

## Configuring the Bluetooth® settings

### Setting the use of Bluetooth®

Enables/disables the Bluetooth function.

#### Setup menu

"Bluetooth" > "Bluetooth"

#### Settings

Off	Disables the Bluetooth function.
On	Enables the Bluetooth function.

### Terminating the connection between a Bluetooth® device and the unit

Terminates the Bluetooth connection between a Bluetooth device (such as a smartphone) and the unit.

#### Setup menu

"Bluetooth" > "Audio Receive" > "Disconnect"

Select "Disconnect" and press ENTER to terminate the Bluetooth connection.

#### Note

This setting is not available when no Bluetooth devices are connected.

### Setting the use of the Bluetooth® Standby function

Selects whether to enable/disable the function that turns on the unit from Bluetooth devices (Bluetooth standby). If this function is set to "On", the unit automatically turns on when a connect operation is performed on the Bluetooth device.

#### Setup menu

"Bluetooth" > "Audio Receive" > "Bluetooth Standby"

#### Settings

Off	Disables the Bluetooth standby function.
On	Enables the Bluetooth standby function. (The unit consumes more power than when "Off" is selected.)

#### Note

This setting is not available when "Network Standby" is set to "Off". For details, see the following:

- "Setting the use of the Network Standby function" (p.117)



# Configuring the multi zone settings

## Checking the Zone2 information

Displays information about Zone2.

### Setup menu

"Multi Zone" > "Information"

On/Off	The power on/off for Zone2
Input	The input source selected for Zone2
Volume	The volume setting for Zone2
Tone Control	The tone control setting (the level of Treble and Bass) for Zone2

### Note

Use the left/right cursor keys to display other informations in the "Setup" menu.

## Setting the use of volume adjustments for Zone2 output

Enables/disables volume adjustments for Zone2 output.

If you have connected an external amplifier with volume control to the unit, disable volume adjustments for Zone2.

### Setup menu

"Multi Zone" > "Zone2" > "Volume"

### Settings

Fixed	Disables volume adjustments for Zone2 output.
Variable	Enables volume adjustments for Zone2 output.

### Note

"Volume" is automatically set to "Variable" when "Power Amp Assign" is set to "7.1 +1Zone" or "5.1.2 +1Zone". For details on "Power Amp Assign" in the "Setup" menu, see the following:

- "Setting your speaker system" (p.94)

## Setting the Zone2 limit value of the volume

Sets the Zone2 limit value of the volumes.

### Setup menu

"Multi Zone" > "Zone2" > "Max Volume"

### Setting range

-60.0 dB to +10.0 dB (5.0 dB increments) [20.5 to 90.5 (5.0 increments)]

### Note

- This setting is not available when "Volume" is set to "Fixed". For details, see the following:
  - "Setting the use of volume adjustments for Zone2 output" (p.121)
- For details on the scale of the volume display (dB unit or numeric value), see the following:
  - "Setting the scale of the volume display" (p.130)

## Setting the Zone2 initial volume for when the unit is turned on

---

Sets the Zone2 initial volume for when the unit is turned on.

### Setup menu

"Multi Zone" > "Zone2" > "Initial Volume"

### Settings

Off		Sets the level at the volume level of the unit when it last entered standby mode.
	Mute	Sets the unit to mute the audio output.
On	-80.0 dB to +10.0 dB (0.5 dB increments) [0.5 to 90.5 (0.5 increments)]	Sets the level to the specified volume level.

### Note

- This setting is not available when "Volume" is set to "Fixed". For details, see the following:
  - "Setting the use of volume adjustments for Zone2 output" (p.121)
- This setting works only when the volume level is set lower than "Max Volume" in "Zone2". For details, see the following:
  - "Setting the Zone2 limit value of the volume" (p.121)
- For details on the scale of the volume display (dB unit or numeric value), see the following:
  - "Setting the scale of the volume display" (p.130)

## Adjusting the time deviation in relation to the main zone

---

Adjusts the time deviation in relation to the main zone.

### Setup menu

"Multi Zone" > "Zone2" > "Audio Delay"

### Setting range

0 ms to 100 ms (1 ms increments)

## Switching between stereo and monaural for Zone2 output

---

Switches between stereo and monaural for Zone2 output.

### Setup menu

"Multi Zone" > "Zone2" > "Monaural"

### Settings

Off	Produces stereo sounds in Zone2.
On	Produces monaural sounds in Zone2.

## Setting the use of Compressed Music Enhancer for Zone2 output

---

Enables/disables Compressed Music Enhancer for Zone2 output.

### Setup menu

"Multi Zone" > "Zone2" > "Enhancer"

### Settings

Off	Disables Compressed Music Enhancer.
On	Enables Compressed Music Enhancer.

## Adjusting the tone for Zone2 output

---

Adjusts the level of high-frequency range (Treble) and low-frequency range (Bass) for Zone2 output.

### Setup menu

"Multi Zone" > "Zone2" > "Tone Control"

### Choices

Treble, Bass

### Settings

Auto	Adjusts the levels of the high-frequency range (Treble) and low-frequency range (Bass) automatically in synchronization with the main volume, with correction for the auditory response of the human ear.
Manual	Adjusts the level of high-frequency range (Treble) and low-frequency range (Bass) manually (-6.0 to +6.0 dB, 0.5 dB increments).
Bypass	Does not adjust the level of high-frequency range (Treble) and low-frequency range (Bass).

## Setting the use of Extra Bass for Zone2 output

---

Enables/disables Extra Bass for Zone2 output. When Extra Bass is enabled, you can enjoy enhanced bass sounds, regardless of the size of speakers.

### Setup menu

"Multi Zone" > "Zone2" > "Extra Bass"

### Settings

Off	Disables Extra Bass.
On	Enables Extra Bass.

## Adjusting the volume balance for Zone2 output

---

Adjusts the volume balance for Zone2 output. Higher to enhance the right side, and lower to enhance the left side.

### Setup menu

"Multi Zone" > "Zone2" > "Left / Right Balance"

### Setting range

-20 to +20

## Renaming the zone name

Changes the zone name displayed on the TV screen.

### Setup menu

"Multi Zone" > "Zone Rename"

#### 1 Use the cursor keys to select a zone name to be renamed and press ENTER.

The cursor moves to the name edit screen.

#### 2 Use the cursor keys and ENTER to rename.

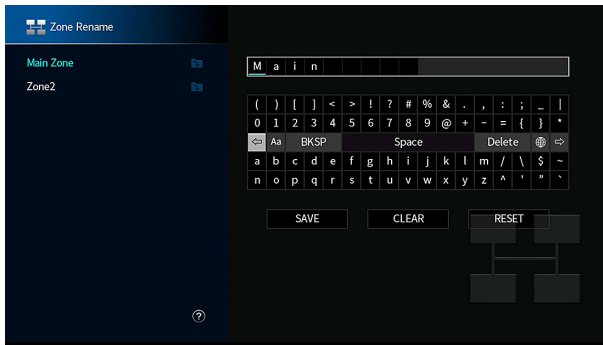

### Note

- To clear the entry, select "CLEAR".
- To restore the default name, select "RESET".

#### 3 Use the cursor keys to select "SAVE" and press ENTER.

#### 4 Press SETUP.

This completes the settings.

## Setting the use of switching to the party mode on Zone2

Enables/disables switching to the party mode.

### Setup menu

"Multi Zone" > "Party Mode Set" > "Target : Zone2"

### Settings

Disable	Disables switching to the party mode.
Enable	Enables switching to the party mode. You can turn on/off the party mode by pressing PARTY on the remote control.

### Note

For details on party mode, see the following:

- "Enjoying the same source in multiple rooms (party mode)" (p.55)

## Configuring the system settings

### Checking the system information on the unit

Displays the system information on the unit.

#### Setup menu

"System" > "Information"

Remote ID	The unit's remote control ID setting
TV Format	The unit's video signal type
Speaker Impedance	The speaker impedance setting of the unit
Tuner Frequency Step	(Asia and General models only) The FM/AM tuning frequency setting of the unit
System ID	System ID number
Firmware Version	The version of firmware installed on the unit

#### Note

Use the left/right cursor keys to display other informations in the "Setup" menu.

### Setting the on-screen menu language

Select the on-screen menu language.

#### Setup menu

"System" > "Language"

#### Settings

English	English
日本語	Japanese
Français	French
Deutsch	German
Español	Spanish
Русский	Russian
Italiano	Italian
中文	Chinese

#### Note

The information on the front display is provided in English only.

## Combining audio of another input source with video of the current input source

Select the audio of a different input source to play back together with the video of the currently selected input source. For example, use this function in the following cases.

- Connecting a playback device that supports HDMI video output, but not HDMI audio output

### Setup menu

“System” > “Audio In”

### Input sources

HDMI 1-5, AV 1-2

### Settings

AV 1-2, AUDIO 1-5

### Video/audio input jacks available on the unit

Output jacks on video device		Input jacks on the unit	
Video	Audio	Video	Audio
HDMI	Digital optical	HDMI 1-5	AUDIO 1 (OPTICAL) AUDIO 2 (OPTICAL)
	Digital coaxial		AV 1 (COAXIAL) AUDIO 3 (COAXIAL)
	Analog stereo		AV 2 (AUDIO) AUDIO 4-5
Component video	Digital optical	AV1 (COMPONENT VIDEO)	AUDIO 1 (OPTICAL) AUDIO 2 (OPTICAL)
	Analog stereo		AV 2 (AUDIO) AUDIO 4-5 (AUDIO)
Composite video	Digital optical	AV2 (COMPOSITE VIDEO)	AUDIO 1 (OPTICAL) AUDIO 2 (OPTICAL)
	Digital coaxial		AV 1 (COAXIAL) AUDIO 3 (COAXIAL)

### Necessary setting

For example, if you have connected a video device to AV 1 (COMPONENT VIDEO) and AV 2 (AUDIO) jack of the unit, change the combination setting as follows.

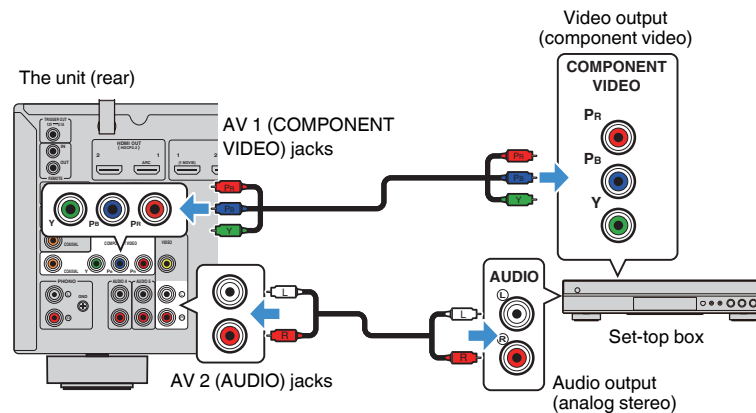

**1** Press **INPUT** to select “AV 1” (video input jack to be used) as the input source.

**2** Press **SETUP**.

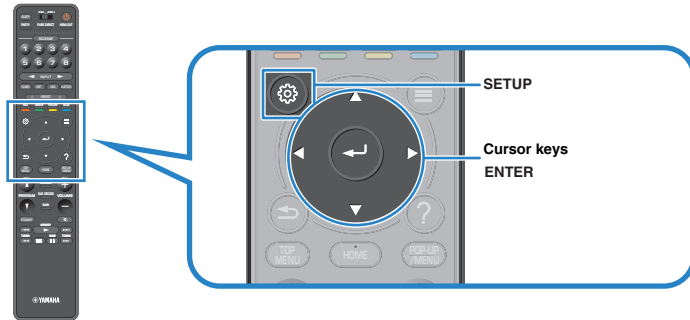

**3** Use the cursor keys to select “System” and press **ENTER**.

**4** Use the cursor keys to select “Audio In” and press **ENTER**.

**5** Use the cursor keys to select “AV 1” and then select “AV 2” (audio input jack to be used).

**6** Press **SETUP**.

This completes the necessary settings.

## Setting input sources to be skipped when operating the **INPUT** key

Set which input sources are skipped when operating the **INPUT** key.

You can select the desired input source quickly by using this function.

### Setup menu

“System” > “Input Skip”

### Input sources

HDMI 1-5, AV 1-2, AUX, AUDIO 1-5, PHONO, TUNER, NET, Bluetooth, USB

### Settings

Off	Does not skip the selected input source.
On	Skips the selected input source.

### Note

When using **AV CONTROLLER**, you cannot select the input sources set to “On” in this function.

## Automatically changing the input source names displayed on the front display

---

Automatically changes the input source names displayed on the front display. You can select a name created by the Auto Rename function.

### Setup menu

"System" > "Input Rename"

### Input sources

HDMI 1-5, AV 1, AUDIO 1-3

- 1 Use the cursor keys to select an input source to be renamed.**
- 2 Use the cursor keys to select "Auto".**
- 3 To change another input source name, repeat steps 1 to 2.**
- 4 Press SETUP.**

This completes the settings.

### Note

When "Auto" is selected, the created name is saved even after the external device is disconnected. To reset to the default setting, switch the setting to "Manual" and then back to "Auto".

## Manually changing the input source names displayed on the front display

---

Allows the input source names displayed on the front display to be set manually.

### Setup menu

"System" > "Input Rename"

### Input sources

HDMI 1-5, AV 1-2, AUX, AUDIO 1-5, PHONO, TUNER, MusicCast Link, SERVER, NET RADIO, Bluetooth, USB

- 1 Use the cursor keys to select an input source to be renamed.**
- 2 Press ENTER.**
- 3 Use the cursor keys and ENTER to edit the name.**

### Note

If the input source is set to "Auto", use the cursor keys to select "Manual".

The cursor moves to the name edit screen.

### Note

- To cancel the entry, select "CLEAR".
- To restore the default name, select "RESET".

- 4 Use the cursor keys to select "SAVE" and press ENTER.**
- 5 To change another input source name, repeat steps 1 to 4.**
- 6 Press SETUP.**

This completes the settings.



## Setting the use of Auto Play function

Enables/disables Auto Play function in Internet streaming services and following input sources.

### Setup menu

"System" > "Auto Play"

### Input sources

(network sources), SERVER, NET RADIO, Bluetooth, USB

### Settings

Off	Disables Auto Play function.
On	Starts automatically to play back the last content which you played back.
Auto	Starts automatically to play back the content which only you played back at setting the unit to standby mode.

### Note

In some input sources or content, you might not enable Auto Play function.

## Setting sound programs to skip when operating the PROGRAM key

Set which sound programs are skipped when operating the PROGRAM key.

You can select the desired sound program quickly by using this function.

### Setup menu

"System" > "DSP Skip"

### Settings

Off	Does not skip the selected sound program.
On	Skips the selected sound program.

## Setting the function for the PROGRAM key on the remote control

Sets the function that is assigned to the PROGRAM key on the remote control. You can use the PROGRAM key for other than DSP program selection.

### Setup menu

"System" > "Remote Key" > "PROGRAM Key"

### Settings

Assign1	Enables selecting the DSP Programs.
Assign2	Enables selecting just the DSP Movie/Music Programs.
	The up key of the PROGRAM keys: toggle between the Movie Programs The down key of the PROGRAM keys: toggle between the Music Programs
Assign3	Enables selecting the NETWORK sources.
Assign4	Enables moving to the previous/next page of the Browse Screen.
Assign5	Enables fine-adjusting the subwoofer volume.
Assign6	Enables adjusting the volume of dialogue sounds.
Assign7	Enables selecting shuffle/repeat settings.
	The up key of the PROGRAM keys: repeat The down key of the PROGRAM keys: shuffle
Assign8	Displays the front/on-screen display information.
	The up key of the PROGRAM keys: front display information The down key of the PROGRAM keys: on-screen display information

### Note

This setting does not change the function of the PROGRAM key on the front panel.

## Setting the unit's functions for the RED/GREEN/YELLOW/BLUE keys of the remote control

Set the unit's functions for the RED/GREEN/YELLOW/BLUE keys of the remote control.

### Setup menu

"System" > "Remote Key" > "Color Key"

### Settings

Default	Assigns the functions of devices connected to the unit with an HDMI cable. This setting is effective when "HDMI Control" is set to "On".
TV Control	Assigns the functions of TV Control to each key. RED: EXIT (closes the menu on the TV) GREEN: INFO (displays information about the TV such as the resolution) YELLOW: BROADCAST (switches the TV broadcast type) BLUE: INPUT (switches the TV input) This setting is effective when "HDMI Control" is set to "On".

### Note

- For details on "HDMI Control" in the "Setup" menu, see the following:
  - "Setting the use of HDMI Control" (p.114)
- To use HDMI control, you need to perform the HDMI Control link setup after connecting HDMI Control-compatible devices. For details, see the following:
  - "HDMI Control and synchronized operations" (p.170)
- HDMI Control might not work properly.

## Adjusting the brightness of the front display

Adjusts the brightness of the front display.

### Setup menu

"System" > "Display Set" > "Dimmer (Front Display)"

### Setting range

-4 to 0 (higher to brighten)

### Note

The front display may become dark when "ECO Mode" is set to "On". For details, see the following:

- "Setting the use of the eco mode" (p.132)

## Setting the scale of the volume display

Switches the scale of the volume display.

### Setup menu

"System" > "Display Set" > "Volume"

### Settings

dB	Displays the volume in the "dB" unit.
0-97	Displays the volume in the numeric value (0-97).

## Setting the use of short messages on the TV

Selects whether to display short messages on the TV screen when the unit is operated (such as input selection and volume adjustment).

### Setup menu

"System" > "Display Set" > "Short Message"

### Settings

Off	Does not display short messages on the TV screen.
On	Displays short messages on the TV screen.

## Setting the image to be used as wallpaper on the TV

Selects the image to be used as wallpaper on the TV.

### Setup menu

"System" > "Display Set" > "Wallpaper"

### Settings

Piano	Displays the piano image on the TV screen when there is no video signal.
Gray	Displays a gray background on the TV screen when there is no video signal.

## Specifying the condition for the TRIGGER OUT jack to function

Specifies the condition for the TRIGGER OUT jack to function.

### Setup menu

"System" > "Trigger Output" > "Trigger Mode"

### Settings

Power	The TRIGGER OUT jack functions in sync with the power status of the zone specified with "Target Zone."
Source	The TRIGGER OUT jack functions in sync with the input switching in the zone specified with "Target Zone." An electronic signal is transmitted according to the setting made in "Source."
Manual	Select this to manually switch the output level for electronic signal transmission with "Manual."

### Note

For details on "Target Zone" in the "Setup" menu, see the following:

- "Specifying the zone with which the TRIGGER OUT jack functions are synchronized" (p.131)

## Specifying the output level of the electronic signal transmitted with each input

Specifies the output level of the electronic signal transmitted with each input, switching when "Trigger Mode" is set to "Source".

### Setup menu

"System" > "Trigger Output" > "Trigger Mode" > "Source"

### Choices

HDMI 1-5, AV 1-2, AUX, AUDIO 1-5, TUNER, PHONO, (network sources), Bluetooth, USB, AirPlay, MusicCast Link, SERVER, NET RADIO

### Settings

Low	Stops the electronic signal transmission when you switch to the input source specified in this option.
High	Transmits the electronic signal when you switch to the input source specified in this option.

## Switching the output level for electronic signal transmission manually

Switches the output level for electronic signal transmission manually when "Trigger Mode" is set to "Manual". This setting can also be used to confirm proper function of the external device connected via the TRIGGER OUT jack.

### Setup menu

"System" > "Trigger Output" > "Trigger Mode" > "Manual"

### Settings

Low	Stops the electronic signal transmission.
High	Transmits the electronic signal.

## Specifying the zone with which the TRIGGER OUT jack functions are synchronized

Specifies the zone with which the TRIGGER OUT jack functions are synchronized.

### Setup menu

"System" > "Trigger Output" > "Target Zone"

### Settings

Main	When "Trigger Mode" is set to "Power," electronic signal transmission is synchronized with the power status of the main zone. When "Trigger Mode" is set to "Source," electronic signal transmission is synchronized with the input switching in the main zone.
Zone2	When "Trigger Mode" is set to "Power," electronic signal transmission is synchronized with the power status of Zone2. When "Trigger Mode" is set to "Source," electronic signal transmission is synchronized with the input switching in Zone2.
All	When "Trigger Mode" is set to "Power," electronic signal transmission is synchronized with the power status of the main zone or Zone2. When "Trigger Mode" is set to "Source," electronic signal transmission is synchronized with the input switching in the main zone or Zone2.

### Note

For details on "Trigger Mode" in the "Setup" menu, see the following:

- "Specifying the condition for the TRIGGER OUT jack to function" (p.131)

## Setting the amount of time for the auto-standby function

Set the amount of time for the auto-standby function.

### Setup menu

"System" > "ECO" > "Auto Power Standby"

### Settings

Off	Does not set the unit to standby mode automatically.
5 minutes, 20 minutes	Sets the unit to standby mode when you have not operated the unit and the unit has not detected any input signal for the specified time.
2 hours, 4 hours, 8 hours, 12 hours	Sets the unit to standby mode when you have not operated the unit for the specified time.

### Note

Just before the unit enters standby mode, "AutoPowerStdby" appears and then countdown starts in the front display.

## Setting the use of the eco mode

You can reduce the unit's power consumption by setting the eco mode to "On". After changing the setting, be sure to press ENTER to restart the unit.

When the eco mode is enabled, you can reduce the unit's power consumption.

### Setup menu

"System" > "ECO" > "ECO Mode"

### Settings

Off	Disables the eco mode.
On	Enables the eco mode.

### Note

- When "ECO Mode" is set to "On", the front display may become dark.
- If you want to play audio at high volume, set "ECO Mode" to "Off".

## Preventing accidental changes to the settings

Prevents accidental changes to the settings.

### Setup menu

"System" > "Memory Guard"

### Settings

Off	Does not protect the settings.
On	Protects the settings until "Off" is selected.

### Note

When "Memory Guard" is set to "On", the lock icon (🔒) is displayed on the menu screen.

## Updating the firmware via the network

---

Updates the firmware via the network. You can also check the firmware version and system ID.

### Setup menu

"System" > "Firmware Update"

### Choices

---

Firmware Update	Starts the process to update the unit's firmware.
USB Update	Displays how to update the firmware using a USB memory device in the "ADVANCED SETUP" menu.

---

### Note

- "Firmware Update" is not selectable when firmware update is in preparation.
- Firmware update takes about 20 minutes or more.
- If the Internet connection speed is slow, or the unit is connected to the wireless network, network update may not be possible depending on the condition of the network. In this case, wait until firmware update is ready, or update the firmware using the USB memory device. For details on using the USB memory device, see the following:
  - "Updating the firmware (UPDATE)" (p.138)

# Configuring the advanced settings (ADVANCED SETUP menu)

## Basic operation of the ADVANCED SETUP menu

Perform the following basic procedure to operate the “ADVANCED SETUP” menu while viewing the front display.

- 1 **Set the unit to standby mode.**
- 2 **While holding down STRAIGHT on the front panel, press  $\text{\textcircled{P}}$  (power).**

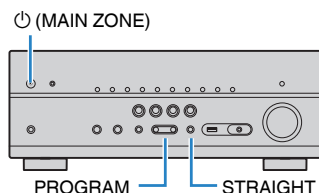

The top item and its setting of the “ADVANCED SETUP” menu appear on the front display.

- 3 **Press PROGRAM to select an item.**
- 4 **Press STRAIGHT to select a setting.**
- 5 **Press  $\text{\textcircled{P}}$  (power) to set the unit to standby mode and turn it on again.**

This completes the settings.

### Note

For details on the default settings, see the following:

- “Default settings of the ADVANCED SETUP menu” (p.180)

## ADVANCED SETUP menu items

Use the following table to configure system settings of the unit.

Item	Function	Page
SP IMP.	Changes the speaker impedance setting.	p.135
REMOTE ID	Selects the unit's remote control ID.	p.135
TU	(Asia and General models only) Changes the FM/AM tuning frequency setting.	p.135
TV FORMAT	Switches the video signal type of HDMI output.	p.135
MON.CHK	Removes the limitation on HDMI video output.	p.136
4K MODE	Selects the HDMI 4K signal format.	p.136
DTS MODE	Selects the information to be sent to the BD player connected to the unit about the DTS formats that the unit supports.	p.137
BKUP/RSTR	Backups and restores all the settings for the unit.	p.137
INIT	Restores the default settings.	p.138
UPDATE	Updates the firmware.	p.138
VERSION	Checks the version of firmware currently installed on the unit.	p.138

## Changing the speaker impedance setting (SP IMP.)

SP IMP. •• 8ΩMIN

Change the unit's speaker impedance settings depending on the impedance of the speakers connected.

### ADVANCED SETUP menu

"SP IMP."

#### Settings

6 Ω MIN	Select this option when you connect 6-ohm speakers to the unit.
8 Ω MIN	Select this option when you connect 8-ohm or higher speakers to the unit.

## Selecting the remote control ID (REMOTE ID)

REMOTE ID •• ID1

Change the unit's remote control ID so that it matches the remote control's ID (default: ID1). When using multiple Yamaha AV receivers, you can set each remote control with a unique remote control ID for its corresponding receiver.

### ADVANCED SETUP menu

"REMOTE ID"

#### Settings

ID1, ID2

#### Changing the remote control ID of the remote control

- To select ID1, while holding down the left cursor key, hold down SCENE (1) for 5 seconds.
- To select ID2, while holding down the left cursor key, hold down SCENE (2) for 5 seconds.

## Changing the FM/AM tuning frequency setting (TU)

(Asia and General models only)

TU •••• FM50/AM9

Change the FM/AM tuning frequency setting of the unit depending on your country or region.

### ADVANCED SETUP menu

"TU"

#### Settings

FM100/AM10	Select this when you want to adjust the FM frequency by 100-kHz steps and AM by 10-kHz steps.
FM50/AM9	Select this when you want to adjust the FM frequency by 50-kHz steps and AM by 9-kHz steps.

## Switching the video signal type (TV FORMAT)

TV FORMAT • NTSC

Switch the video signal type of HDMI output so that it matches to the format of your TV. Since the unit automatically selects the video signal type so that it matches to the TV, it is unnecessary to change the setting normally. Change the setting only when images on the TV screen do not appear correctly.

### ADVANCED SETUP menu

"TV FORMAT"

#### Settings

NTSC, PAL

## Removing the limitation on HDMI video output (MON.CHK)

MON.CHK . . . . YES

The unit automatically detects resolutions supported by a TV connected to the HDMI OUT jack.

Disable the monitor check function if you want to specify a resolution in “Resolution” when the unit cannot detect the TV’s resolution or when you want to specify a different resolution than the detected resolution.

### ADVANCED SETUP menu

“MON.CHK”

#### Settings

YES	Enables the monitor check function. (Outputs video signals with a resolution supported by the TV only.)
SKIP	Disables the monitor check function. (Outputs video signals with a specified resolution regardless of compatibility with the TV.)

#### Note

- For details on “Resolution” in the “Setup” menu, see the following:
  - “Setting a resolution to output HDMI video signals” (p.113)
- Reset to “YES” if the unit becomes inoperable because video from the unit cannot be displayed on the TV after “MON.CHK” has been set to “SKIP”.

## Selecting the HDMI 4K signal format (4K MODE)

4K MODE MODE 1

Selects the format of signals input/output at the unit when HDMI 4K compatible TV and playback device are connected to the unit.

### ADVANCED SETUP menu

“4K MODE”

#### Settings

MODE 1	Inputs/outputs 4K signals shown in the following table. Depending on the connected device or HDMI cables, video may not be displayed correctly. In this case, select “MODE 2”.
MODE 2	Inputs/outputs 4K signals shown in the following table.

#### Note

When “MODE 1” is selected, use a Premium High Speed HDMI Cable or Premium High Speed Cable with Ethernet.

#### Format

		MODE 1			MODE 2		
		8 bit	10 bit	12 bit	8 bit	10 bit	12 bit
4K/60, 50 Hz	RGB 4:4:4	✓	–	–	–		
	YCbCr 4:4:4	✓	–	–	–		
	YCbCr 4:2:2	–	✓	–	–		
	YCbCr 4:2:0	–	✓	–	✓	–	–
4K/30, 25, 24 Hz	RGB 4:4:4	–	✓	–	✓	–	–
	YCbCr 4:4:4	–	✓	–	✓	–	–
	YCbCr 4:2:2	–	✓	–	–	–	✓



## Setting DTS Format Notification (DTS MODE)

DTS MODE MODE1

This setting informs the BD player about the DTS formats that the unit supports.

### ADVANCED SETUP menu

“DTS MODE”

#### Settings

MODE 1	This mode conforms to the DTS:X standard. Use this setting under normal circumstances.
MODE 2	Use this setting if the BD player fails to properly output a DTS signal even when it is playing back DTS-HD or DTS:X content.

## Backing up and restoring all the settings (BKUP/RSTR)

BKUP/RSTR BKUP

Backups and restores all the unit's setting to a USB memory device. Prepare a USB memory device using FAT16 or FAT32 format in advance.

### ADVANCED SETUP menu

“BKUP/RSTR”

#### Settings

BKUP	Backups all the settings.
RSTR	Restores all the previous backed up settings.

- 1** Connect the USB memory device to the USB jack on the front panel.
- 2** To start the process, press STRAIGHT to select “BKUP” or “RSTR” and then press INFO on the front panel.
- 3** Press INFO again after the confirmation message appears on the front display.

- 4** When “Complete” appears on the front display, press  (power) to set the unit to standby mode and turn it on again.

If “Failed” appears on the front display, check the following and start the process again.

#### In case of “BKUP”:

- You cannot overwrite save. When you save the settings repeatedly, please move the file in different folder.
- The file is stored by the name of “MC\_backup\_(model name).dat” in the route of the USB memory device.

#### In case of “RSTR”:

- Check that the file is stored in the route of the USB memory device.

#### Note

- “RSTR” is effective after backing up all the settings.
- Do not turn off the unit during the backing up and restoring process. Otherwise, the settings may not be restored correctly.
- The user information (such as account, password) is not saved.

## Restoring the default settings (INIT)



INIT \* \* \* \* CANCEL

Restores the default settings for the unit.

### ADVANCED SETUP menu

"INIT"

#### Choices

VIDEO	Restores the default settings for video configurations.
ALL	Restores the default settings for the unit.
CANCEL	Does not perform an initialization.

## Updating the firmware (UPDATE)



UPDATE \* \* \* \* \* USB

New firmware that provides additional features or product improvements will be released as needed. Updates can be downloaded from our website to a USB memory device. You can update the firmware using this USB memory device. For details, refer to the information supplied with updates.

### ADVANCED SETUP menu

"UPDATE"

#### Choices

USB	Update the firmware using a USB memory device.
NETWORK	Update the firmware via the network.

#### Note

Do not perform this menu unless firmware update is necessary. Also, make sure you read the information supplied with updates before updating the firmware.

## Checking the firmware version (VERSION)



VERSION \* \* XX.XX

Check the version of firmware currently installed on the unit.

### ADVANCED SETUP menu

"VERSION"

# TROUBLESHOOTING

## When any problem appears

### If trouble occurs, first check the following:

Make sure of the following when the unit does not function properly.

- The power cables of the unit, TV and playback devices (such as BD/DVD players) are connected to AC wall outlets securely.
- The unit, subwoofer, TV and playback devices (such as BD/DVD players) are turned on.
- The connectors of each cable are securely inserted in to jacks on each device.

If there is no problem with the power and cables, refer to the instructions shown in "When any problem appears" corresponding to the trouble of the unit.

If the problem you are experiencing is not listed or if the instructions do not help, turn off the unit, disconnect the power cable, and contact the nearest authorized Yamaha dealer or service center.

### Power, system, or remote control trouble

#### ■ The power does not turn on

- **The protection circuitry has been activated three times consecutively.**  
If the standby indicator on the unit blinks when you try to turn on the power, as a safety precaution, capability to turn on the power is disabled. Contact your nearest Yamaha dealer or service center to request repair.

#### ■ The power does not turn on in synchronization with the TV

- **HDMI Control on the unit is disabled.**  
If turning off the unit is not synchronized to the TV either, check the setting of HDMI Control on the unit. For details on HDMI Control, see the following:
  - "Setting the use of HDMI Control" (p.114)
- **HDMI Control on the TV is disabled.**  
If only turning on the unit is not synchronized to the TV, check the setting on the TV. For details, refer to the instruction manual for the TV and set HDMI Control on the TV.
- **Because of a power failure, the unit's power is no longer synchronized.**  
Disconnect the HDMI cables and power cables, and after five minutes, reconnect the cables of playback devices first, then the unit, and then the TV. Then, check that the power is synchronized.

#### ■ The power does not turn off

- **The internal microcomputer has frozen, due to an external electric shock (such as lightning or excessive static electricity) or to a drop in the power supply voltage.**  
Hold down ⏻ (power) on the front panel for more than 15 seconds to reboot the unit. If the problem persists, disconnect the power cable from the AC wall outlet and plug it again.

## ■ The power turns off (standby mode) immediately

- **The unit was turned on while a speaker cable was shorted.**

Twist the bare wires of each speaker cable firmly and reconnect to the unit and speakers. For details, see the following:

  - “Connecting the speaker” (p.18)

## ■ The unit enters standby mode automatically

- **The sleep timer worked.**

Turn on the unit and start playback again.
- **The auto-standby function activated because the unit was not used for the specified time.**

To disable the auto-standby function, set “Auto Power Standby” in the “Setup” menu to “Off”. For details, see the following:

  - “Setting the amount of time for the auto-standby function” (p.132)
- **The speaker impedance setting is incorrect.**

Set the speaker impedance to match your speakers. For details, see the following:

  - “Changing the speaker impedance setting (SP IMP.)” (p.135)
- **The protection circuitry has been activated because of a short circuit.**

Twist the bare wires of each speaker cable firmly and reconnect to the unit and speakers. For details, see the following:

  - “Connecting the speaker” (p.18)

## ■ The unit is not reacting

- **The internal microcomputer is frozen, due to an external electric shock (such as lightning or excessive static electricity) or to a drop in the power supply voltage.**

Hold down ⏻ (power) on the front panel for more than 15 seconds to reboot the unit. If the problem persists, disconnect the power cable from the AC wall outlet and plug it again.

## ■ The unit cannot be controlled using the remote control

- **The unit is out of the operating range.**

Use the remote control within the operating range. For details, see the following:

  - “Operating range of the remote control” (p.8)
- **The batteries are weak.**

Replace with new batteries.
- **The unit’s remote control sensor is exposed to direct sunlight or strong lighting.**

Adjust the lighting angle, or reposition the unit.
- **The remote control IDs of the unit and the remote control are not identical.**

Change the remote control ID of the unit or the remote control. For details, see the following:

  - “Selecting the remote control ID (REMOTE ID)” (p.135)
- **The remote control is set to the Zone2 operation mode.**

Set the remote control to the Main zone operation mode. For details, see the following:

  - “Part names and functions of the remote control” (p.15)

## ■ Cannot select the desired input source even if “INPUT” is pressed

- **The function which skips some input sources is set.**

Set “Input Skip” of the desired input source in the “Setup” menu to “Off”. For details, see the following:

- “Setting input sources to be skipped when operating the INPUT key” (p.127)

## ■ The RED/GREEN/YELLOW/BLUE keys of the remote control do not operate

- **The device which is connected to the unit via HDMI does not support the operation of the RED/GREEN/YELLOW/BLUE keys.**

Use a device which supports the operation of the RED/GREEN/YELLOW/BLUE keys.

- **The settings of the RED/GREEN/YELLOW/BLUE keys of the unit's remote control have been changed.**

Set the “Color Key” settings in the “Setup” menu to “Default”. For details, see the following:

- “Setting the unit's functions for the RED/GREEN/YELLOW/BLUE keys of the remote control” (p.130)

## Audio trouble

---

### ■ No sound

- **Another input source is selected.**

Select an appropriate input source with the input selection keys. For details, see the following:

- “Basic procedure for playing back video and music” (p.56)

- **Signals that the unit cannot reproduce are being input.**

Some digital audio formats cannot be played back on the unit. Ensure that the signals are types that the unit is able to play back. For details on supported file formats, HDMI audio formats or compatible decoding format, see the following:

- “Supported file formats” (p.168)
- “Specifications” (p.174)

- **The power of Zone2 is not turned on.**

Slide the Zone switch to “ZONE 2”, and then press  (receiver power) to the power of Zone2 turns on. For details, see the following:

- “Controlling Zone2” (p.54)

- **The cable connecting the unit and playback device is defective.**

If there is no problem with the connection, replace with another cable.

### ■ The volume cannot be increased

- **The maximum volume is set too low.**

Use “Max Volume” in the “Setup” menu to adjust the maximum volume. For details, see the following:

- “Setting the limit value of the volume” (p.109)

- **A device connected to the output jacks of the unit is not turned on.**

Turn on all devices connected to the output jacks of the unit.

## ■ No sound is coming from a specific speaker

- **The playback source does not contain a signal for the channel.**

To check it, display information about the current audio signal on the TV. For details, see the following:

  - “Checking the current audio signal information” (p.101)
- **The currently selected sound program/decoder does not use the speaker.**

To check it, use “Test Tone” in the “Setup” menu. For details, see the following:

  - “Outputting test tones” (p.100)
- **Audio output of the speaker is disabled.**

Perform YPAO or use “Configuration” in the “Setup” menu to change the speaker settings. For details, see the following:

  - “Optimizing the speaker settings automatically (YPAO)” (p.38)
  - “Setting the use of a subwoofer” (p.98)
  - “Setting the size of the front speakers” (p.94)
  - “Setting the use of a center speaker and its size” (p.95)
  - “Setting the use of surround speakers and their size” (p.95)
  - “Setting the use of surround back speakers and their size” (p.96)
  - “Setting the use of presence speakers and their size” (p.97)
- **The volume of the speaker is set too low.**

Perform YPAO or use “Level” in the “Setup” menu to adjust the speaker volume. For details, see the following:

  - “Optimizing the speaker settings automatically (YPAO)” (p.38)
  - “Adjusting the volume of each speaker” (p.99)
- **The speaker cable connecting the unit and the speaker is defective.**

Check the unit’s SPEAKERS terminals and the speaker’s terminals. If there is no problem with the connection, replace a breaking speaker cable with another speaker cable.
- **The speaker is malfunctioning.**

To check it, replace with another speaker. If the problem persists with using another speaker, the unit may be malfunctioning.

## ■ No sound is coming from the subwoofer

- **The playback source does not contain Low Frequency Effect (LFE) or low-frequency signals.**

To check it, set “Extra Bass” in the “Option” menu to “On”, in order to output the front channel low-frequency components from the subwoofer. For details, see the following:

  - “Setting the use of Extra Bass” (p.83)
- **Subwoofer output is disabled.**

Perform YPAO or set “Subwoofer” in the “Setup” menu to “Use”. For details, see the following:

  - “Optimizing the speaker settings automatically (YPAO)” (p.38)
  - “Setting the use of a subwoofer” (p.98)
- **The volume of the subwoofer is too low.**

Adjust the volume on the subwoofer.
- **The subwoofer has been turned off by its auto-standby function.**

Disable the auto-standby function of the subwoofer or adjust its sensitivity level.

## ■ No sound from the playback device connected to the unit with HDMI

- **The TV does not support HDCP (High-bandwidth Digital Content Protection).**  
Refer to the instruction manuals for the TV and check the TV's specifications.
- **The number of devices connected to the HDMI OUT jack exceeds the limit.**  
Disconnect some of the HDMI devices.

## ■ No sound from the playback device when HDMI Control is used

- **The TV is set to output audio from the TV speakers.**  
Change the audio output setting on your TV so that the playback device audio is output from the speakers connected to the unit.
- **TV audio is selected as the input source.**  
Select an appropriate input source with the input selection keys.

## ■ No sound from the TV when HDMI Control is used

- **The TV is set to output audio from the TV speakers.**  
Change the audio output setting on your TV so that the TV audio is output from the speakers connected to the unit.
- **A TV that does not support ARC is connected to the unit only with an HDMI cable.**  
Use a digital optical cable to make an audio connection. For details, see the following:
  - “HDMI connection with a TV” (p.29)
- **If the TV is connected to the unit with an audio cable, the TV audio input setting does not match the actual connection.**  
Use “TV Audio Input” in the “Setup” menu to select the correct audio input jack. For details, see the following:
  - “Setting the audio jack used for TV audio input” (p.114)
- **If you are trying to use ARC, ARC is disabled on the unit or TV.**  
Set “ARC” in the “Setup” menu to “On”, and enable ARC on the TV. For details, see the following:
  - “Setting the use of ARC” (p.114)

## ■ Only the front speakers work on multichannel audio

- **The playback device is set to output 2-channel audio (such as PCM) only.**  
To check it, display information about the current audio signal on the TV. If necessary, change the digital audio output setting on the playback device. For details, see the following:
  - “Checking the current audio signal information” (p.101)

## ■ Noise/hum is heard

- **The unit is too close to another digital or radio frequency device.**  
Move the unit further away from the device.
- **The cable connecting the unit and playback device is defective.**  
If there is no problem with the connection, replace with another cable.

## ■ The sound is distorted

- **The volume of the unit is too high.**  
Turn down the volume. If “ECO Mode” in the “Setup” menu is set to “On”, set it to “Off”. For details, see the following:
  - “Setting the use of the eco mode” (p.132)
- **A device (such as an external power amplifier) connected to the unit's audio output jacks is not turned on.**  
Turn on all devices connected to the unit's audio output jacks.

## Video trouble

---

### ■ No video

- **Another input source is selected on the unit.**  
Select an appropriate input source with the input selection keys.
- **Another input source is selected on the TV.**  
Switch the TV input to display the video from the unit.
- **The video signal output from the unit is not supported by the TV.**  
Check the video output setting of the playback device. For information about video signals supported by the TV, refer to the instruction manuals for the TV.
- **The cable connecting the unit and TV (or playback device) is defective.**  
If there is no problem with the connection, replace with another cable.

### ■ No video from the playback device connected to the unit with HDMI

- **The input video signal (resolution) is not supported by the unit.**  
To check the information about the current video signal (resolution) and video signals supported by the unit, see the following:
  - “Checking the current video and HDMI signal information” (p.113)
  - “HDMI signal compatibility” (p.172)
- **The TV does not support HDCP (High-bandwidth Digital Content Protection).**  
Refer to the instruction manuals for the TV and check the TV's specifications.
- **The number of devices connected to the HDMI OUT jack is over the limit.**  
Disconnect some of the HDMI devices.

### ■ No image (contents required the HDCP 2.2 - compatible HDMI device) from the playback device

- **The TV (HDMI input jack) does not support HDCP 2.2.**  
Connect the unit to the TV (HDMI input jack) that supports HDCP 2.2. (The Warning message can be displayed on the TV screen.)

### ■ The menu of the unit is not displayed on the TV

- **Another input source is selected on the TV.**  
Switch the TV input to display the video from the unit (HDMI OUT jack).

### ■ The video is interrupted

- **If you are using two TVs in the Main zone, another TV is turned off when “HDMI OUT 1+2” is selected.**  
Select “HDMI OUT 1” or “HDMI OUT 2” to output the signals only to the TV you are using. For details on selecting HDMI output, see the following:
  - “Selecting an HDMI output jack” (p.57)



## FM/AM radio trouble

---

### ■ FM radio reception is weak or noisy

- **There is multi-path interference.**

Adjust the FM antenna height or orientation, or place it in a different location.

- **Your area is too far from the FM station transmitter.**

To select monaural FM radio reception, set "FM Mode" in the "Option" menu to "Monaural". Or use an outdoor FM antenna. For details on "FM Mode", see the following:

– "Switching between stereo and monaural for FM radio reception" (p.84)

### ■ AM radio reception is weak or noisy

- **The noises may be caused by fluorescent lamps, motors, thermostats, or other electrical equipment.**

It is difficult to completely eliminate noise. It may be reduced by using an outdoor AM antenna.

### ■ Radio stations cannot be selected automatically

- **Your area is too far from the FM station transmitter.**

Select the station manually. Or use an outdoor antenna. We recommend using a sensitive multi-element antenna. For details on selecting the station manually, see the following:

– "Selecting a frequency for reception" (p.61)

- **The AM radio signal is weak.**

Adjust the AM antenna orientation. Select the station manually. Use an outdoor AM antenna. For details on selecting the station manually, see the following:

– "Selecting a frequency for reception" (p.61)

### ■ AM radio stations cannot be registered as presets

- **Auto Preset has been used.**

Auto Preset is for registering FM radio stations only. Register AM radio stations manually. For details, see the following:

– "Registering a radio station manually" (p.63)

## USB trouble

---

### ■ The unit does not detect the USB device

- **The USB device is not connected to the USB jack securely.**

Turn off the unit, reconnect your USB device, and turn the unit on again.

- **The file system of the USB device is not FAT16 or FAT32.**

Use a USB device with FAT16 or FAT32 format.

### ■ Folders and files in the USB device cannot be viewed

- **The data in the USB device is protected by the encryption.**

Use a USB device without an encryption function.

### ■ The unit does not perform continuous playback on files of USB device

- **When the unit detects a series of unsupported files during playback, playback stops automatically.**

Do not save unsupported files (such as images and hidden files) in folders for playback.

## Network trouble

---

### ■ The network feature does not function

- **The network parameters (IP address) have not been obtained properly.**

Enable the DHCP server function on your router and set “DHCP” in the “Setup” menu to “On” on the unit. If you want to configure the network parameters manually, check that you are using an IP address which is not used by other network devices in your network. For details, see the following:

  - “Setting the network parameters automatically (DHCP)” (p.116)
  - “Setting the network parameters manually” (p.117)
- **The unit does not support IPv6 network.**

Connect IPv4 network.

### ■ The unit cannot connect to the Internet via a wireless router (access point)

- **The wireless router (access point) is turned off.**

Turn on the wireless router.
- **The unit and the wireless router (access point) are too far apart.**

Place the unit and the wireless router (access point) closer to each other.
- **There is an obstacle between the unit and the wireless router (access point).**

Move the unit and the wireless router (access point) in a location where there are no obstacles between them.
- **The wireless router (access point) is set to use the wireless channel 14.**

Change settings of the wireless router (access point) to use one of the wireless channels from 1 to 13.

### ■ Wireless network is not found

- **Microwave ovens or other wireless devices in your neighborhood might disturb the wireless communication.**

Turn off these devices.
- **Access to the network is restricted by the firewall settings of the wireless router (access point).**

Check the firewall setting of the wireless router (access point).

### ■ The unit does not detect the media server (PC/NAS)

- **The media sharing setting is not correct.**

Configure the sharing setting and select the unit as a device to which music contents are shared. For details, see the following:

  - “Media sharing setup on media servers (PCs/NAS)” (p.69)
- **Some security software installed on your media server is blocking the access of the unit to your media server.**

Check the settings of security software installed on your media server.
- **The unit and media server are not in the same network.**

Check the network connections and your router settings, and then connect the unit and the media server to the same network.
- **The MAC address filter is enabled on the unit.**

In “MAC Address Filter” in the “Setup” menu, disable the MAC address filter or specify the MAC address of your media server to allow it to access to the unit. For details, see the following:

  - “Setting the MAC address filter” (p.118)

### ■ The files in the media server (PC/NAS) cannot be viewed or played back

- **The files are not supported by the unit or the media server.**

Use the file format supported by both the unit and the media server. For information about the file formats supported by the unit, see the following:

  - “Supported file formats” (p.168)

## ■ The Internet radio cannot be played

- **The selected Internet radio station is currently not available.**

There may be a network problem at the radio station, or the service may have been stopped. Try the station later or select another station.

- **The selected Internet radio station is currently broadcasting silence.**

Some Internet radio stations broadcast silence at certain times of the day. Try the station later or select another station.

- **Access to the network is restricted by the firewall settings of your network devices (such as the router).**

Check the firewall settings of your network devices. The Internet radio can be played only when it passes through the port designated by each radio station. The port number varies depending on the radio station.

## ■ The iPhone does not recognize the unit when using AirPlay

- **The unit is connected to a multiple SSID router.**

Access to the unit might be restricted by the network separation function on the router. Connect the iPhone to the SSID which can access the unit. (Connect it to the Primary SSID at the top of the list.)

## ■ The application for mobile devices does not detect the unit

- **The unit and mobile device are not in the same network.**

Check the network connections and your router settings, and then connect the unit and mobile device to the same network.

- **The MAC address filter is enabled on the unit.**

In "MAC Address Filter" in the "Setup" menu, disable the MAC address filter or specify the MAC address of your mobile device to allow it to access to the unit. For details, see the following:

– "Setting the MAC address filter" (p.118)

- **The unit is connected to a multiple SSID router.**

Access to the unit might be restricted by the network separation function on the router. Connect the iPhone to the SSID which can access the unit. (Connect it to the Primary SSID at the top of the list.)

## ■ Firmware update via the network is failed

- **It may not be possible depending on the condition of the network.**

Update the firmware via the network again or use a USB memory device. For details, see the following:

– "Updating the firmware via the network" (p.133)

## Bluetooth® trouble

---

### ■ A Bluetooth® connection cannot be established

- **The Bluetooth function of the unit is disabled.**  
Enable the Bluetooth function. For details, see the following:
  - “Setting the use of Bluetooth®” (p.120)
- **Another Bluetooth device is already connected to the unit.**  
Terminate the current Bluetooth connection and then establish a new connection.  
For details, see the following:
  - “Playback Bluetooth® device music on the unit” (p.66)
- **The unit and the Bluetooth device are too far apart.**  
Move the Bluetooth device closer to the unit.
- **There is a device (such as microwave oven and wireless LAN) that outputs signals in the 2.4 GHz frequency band nearby.**  
Move the unit and the Bluetooth device away from those devices.
- **The Bluetooth device does not support A2DP.**  
Use a Bluetooth device that supports A2DP.
- **The connection information registered on the Bluetooth device is not working for some reason.**  
Delete the connection information on the Bluetooth device, and then establish a connection between the Bluetooth device and the unit again. For details, see the following:
  - “Playback Bluetooth® device music on the unit” (p.66)

### ■ No sound is produced, or the sound is interrupted during playback with Bluetooth® connection

- **The volume of the Bluetooth device is set too low.**  
Turn up the volume of the Bluetooth device.
- **The Bluetooth device is not set to send audio signals to the unit.**  
Switch the audio output of the Bluetooth device to the unit.
- **The Bluetooth connection has been terminated.**  
Establish a Bluetooth connection between the Bluetooth device and the unit again.  
For details, see the following:
  - “Playback Bluetooth® device music on the unit” (p.66)
- **The unit and the Bluetooth device are too far apart.**  
Move the Bluetooth device closer to the unit.
- **There is a device (such as microwave oven and wireless LAN) that outputs signals in the 2.4 GHz frequency band nearby.**  
Move the unit and the Bluetooth device away from those devices.

## Error indications on the front display

### Error indications on the front display

Refer to the following table when the error message is indicated on the front display.

Message	Cause	Remedy
<b>Access denied</b>	Access to the media servers (PCs/NAS) is denied.	Configure the sharing settings and select the unit as a device to which music contents are shared. For details, see the following: <ul style="list-style-type: none"> <li>• “Media sharing setup on media servers (PCs/NAS)” (p.69)</li> </ul>
<b>Access error</b>	The unit cannot access the USB device.	Turn off the unit and reconnect your USB device. If the problem persists, try another USB device.
	There is a problem with the signal path from the network to the unit.	Make sure your router and modem are turned on, and check the connection between the unit and your router (or hub). For details, see the following: <ul style="list-style-type: none"> <li>• “Connecting a network cable (wired connection)” (p.33)</li> <li>• “Preparing wireless antennas (wireless connection)” (p.34)</li> </ul>
<b>Check SP Wires</b>	The speaker cables are short circuited.	Twist the bare wires of the cables firmly and connect to the unit and speakers properly. For details, see the following: <ul style="list-style-type: none"> <li>• “Connecting the speaker” (p.18)</li> </ul>
<b>Internal Error</b>	An internal error has occurred.	Contact the nearest authorized Yamaha dealer or service center.
<b>No content</b>	There are no playable files in the selected folder.	Select a folder that contains files supported by the unit.
<b>No device</b>	The unit cannot detect the USB device.	Turn off the unit and reconnect your USB device. If the problem persists, try another USB device.
<b>Not connected</b>	The network cable is not connected.	Connect the network cable properly.
	The wireless router (access point) is not found.	Make sure the wireless router (access point) is turned on.
<b>Please wait</b>	The unit is preparing for connecting to the network.	Wait until the message disappears. If the message stays more than 3 minutes, turn off the unit and turn it on again.
<b>RemID Mismatch</b>	The remote control IDs of the unit and the remote control are not identical.	Change the remote control ID of the unit or the remote control. For details, see the following: <ul style="list-style-type: none"> <li>• “Selecting the remote control ID (REMOTE ID)” (p.135)</li> </ul>
<b>Unable to play</b>	The unit cannot play back the songs stored on the iPhone for some reason.	Check the song data. If it cannot be played on the iPhone itself, the song data or storage area may be defective.
	The unit cannot play back the songs stored on the media servers (PCs/NAS) for some reason.	Ensure that the files are types that the unit is able to play back. If the unit supports the file format, but still cannot play back any files, the network may be overloaded with heavy traffic. For information about the formats supported by the unit, see the following: <ul style="list-style-type: none"> <li>• “Supported file formats” (p.168)</li> </ul>
<b>USB Overloaded</b>	An overcurrent is flowing through the USB device.	Turn off the unit and reconnect your USB device. If the problem persists, try another USB device.
<b>Version error</b>	Firmware update failed.	Update the firmware again. For details, see the following: <ul style="list-style-type: none"> <li>• “Updating the firmware (UPDATE)” (p.138)</li> <li>• “Updating the unit’s firmware via the network” (p.152)</li> </ul>

Message	Cause	Remedy
<b>Update failed.</b>	Firmware update failed.	Press STRAIGHT and select a firmware updating method, then press INFO to update the firmware again. For details, see the following: <ul style="list-style-type: none"> <li>• “Updating the firmware (UPDATE)” (p.138)</li> <li>• “Updating the unit’s firmware via the network” (p.152)</li> </ul>
<b>FILE NOT READY</b>	Preparation for firmware update is not finish yet.	Wait a while before updating the firmware again.

# APPENDIX

## Updating the unit's firmware via the network

### Firmware updates

New firmware that provides additional features or product improvements will be released as needed. If the unit is connected to the Internet, new firmware is downloaded via the network. When a firmware update is ready, the following message appears after SETUP is pressed.

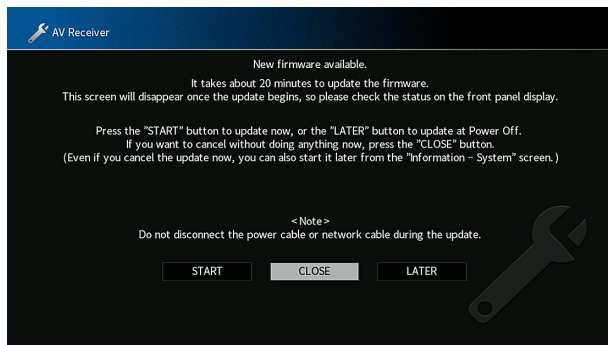

For details on the firmware update, see the following:

- “Updating the unit's firmware via the network” (p.152)

#### Notice

- Do not operate the unit or disconnect the power cable or network cable during firmware update. If the firmware update is interrupted, there is a possibility that the unit will malfunction. In this case, contact your nearest authorized Yamaha dealer or service center to request repair.

#### Note

- The firmware update indicator on the front display lights up when a firmware update is ready. This indicator might not light up when the network connection speed is too slow or a later firmware update is available.
- Firmware update takes about 20 minutes or more.
- You might not get the message or the lighting up firmware update indicator on the front display depending on the condition of the network connection. In this case, update the firmware using the USB memory device. For details, see the following:
  - “Updating the firmware (UPDATE)” (p.138)
- For details on firmware updates, visit the Yamaha website.

## Updating the unit's firmware via the network

---

Confirm the on-screen description displayed after SETUP is pressed, and start the firmware update.

### 1 Read the on-screen description.

### 2 Use the cursor keys to select "START" and press ENTER.

The on-screen display turns off and the firmware update begins.

### 3 If "UPDATE SUCCESS PLEASE POWER OFF!" appears on the front display, press MAIN ZONE on the front panel.

The firmware update is complete.

#### Note

- Firmware update takes about 20 minutes or more.
- You might not get the message or the lighting up firmware update indicator on the front display depending on the condition of the network connection. In this case, update the firmware using the USB memory device. For details on using the USB memory device, see the following:
  - "Updating the firmware (UPDATE)" (p.138)
- For details on update, visit the Yamaha website.
- If you want to perform update when turning off the unit, use the cursor keys to select "LATER" and press ENTER in step 2. When you turn off the unit, a screen asking you to confirm the firmware update is displayed, and press ENTER to start the firmware update. After the firmware update is complete, the unit will turn off automatically.
- To perform update when turning off the unit, refer to the following instructions and supplementary explanations.
  - The firmware update can be started by pressing INFO on the front panel.
  - The unit turns off automatically without performing the firmware update if two minutes pass after the screen to confirm the firmware update is displayed.
  - To cancel the firmware update process, press RETURN, and the unit will turn off.
  - The unit turns off without performing the firmware update if you turn off the unit with AV CONTROLLER or MusicCast CONTROLLER.



# Connecting to a network wirelessly

## Selecting a wireless network connection method

Select a wireless connection method according to your network environment.

### Note

- You need to configure the network settings if your router does not support DHCP or if you want to configure the network parameters manually. For details, see the following:
  - “Setting the network parameters manually” (p.117)
- When the unit is added to a MusicCast network, the network settings can be configured at the same time. If you use MusicCast, this method is recommended. For details, see the following:
  - “Adding the unit to the MusicCast network” (p.44)

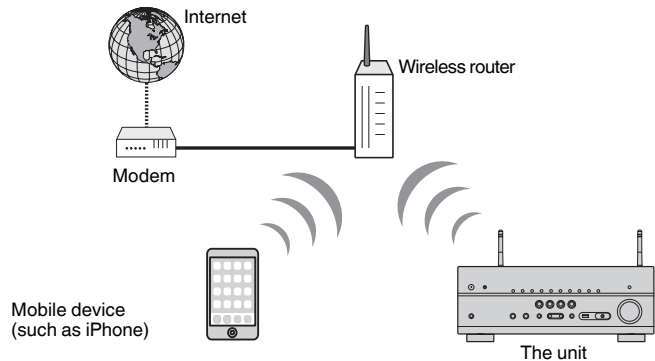

- 1** Press  (receiver power) to turn on the unit.
- 2** Turn on the TV and switch the TV input to display video from the unit (HDMI OUT jack).
- 3** Press **SETUP**.
- 4** Use the cursor keys to select “Network” and press **ENTER**.
- 5** Use the cursor keys to select “Network Connection” and press **ENTER**.
- 6** Use the cursor keys to select “Wireless(Wi-Fi)” and press **ENTER**.
- 7** Use the cursor keys to select “OK” and press **ENTER**.

The following connection methods are available.

- “Setting up a wireless connection using the WPS button” (p.154)
- “Setting up a wireless connection using an iOS device” (p.154)
- “Setting up a wireless connection by selecting from the list of available access points” (p.156)
- “Setting up a wireless connection manually” (p.157)
- “Setting up a wireless connection by using the WPS PIN code” (p.159)

## Setting up a wireless connection using the WPS button

You can easily set up a wireless connection with one push of the WPS button.

### Setup menu

"Network" > "Network Connection" > "Wireless(Wi-Fi)"

- 1 Use the cursor keys to select "WPS Button" and press ENTER.**
- 2 Use the cursor keys to select "NEXT" and press ENTER.**
- 3 Read the on-screen description and push the WPS button on the wireless router (access point).**
- 4 Use the cursor keys to select "CONNECT" and press ENTER.**

When the connection process finishes, "Completed" appears on the front display.

If "Not connected" appears, repeat from step 1 or try another connection method.

This completes the network settings.

### Note

- The unit may not connect to the wireless router (access point) using WEP as the encryption method. In this case, try another connection method.
- You can use INFO (WPS) on the front panel. Hold down INFO (WPS) for a few seconds to set up a wireless connection and then "Press WPS button on Access Point" appears on the front display, push the WPS button.

### About WPS

- WPS (Wi-Fi Protected Setup) is a standard established by the Wi-Fi Alliance, which allows easy establishment of a wireless home network.

## Setting up a wireless connection using an iOS device

You can set up a wireless connection by applying the connection settings on iOS devices (iPhone/iPad/iPod touch).

Before proceeding, confirm that your iOS device is connected to a wireless router.

### Note

- This process will restore the default settings for the following.
  - Network settings
  - Bluetooth settings
  - Bluetooth, USB, media server and network content registered as shortcuts
  - Internet radio stations registered to "Favorites"
  - Account information for the network services
- You need iOS device with iOS 7 or later. (The following procedure is a setup example for iOS 10.)
- This configuration does not work if the security method of your wireless router (access point) is WEP. In this case, use other connection method.

### Setup menu

"Network" > "Network Connection" > "Wireless(Wi-Fi)"

**1** Use the cursor keys to select “Share Wi-Fi Settings (iOS)” and press ENTER.

**2** Use the cursor keys to select “NEXT” and press ENTER.

**3** Read the on-screen description and select “NEXT” and then, press ENTER.

**Note**

When you use wired network connection, a warning message is displayed on the screen. Disconnect the network cable from the unit, and then press ENTER.

**4** On the iOS device, select the unit as the AirPlay speaker in the Wi-Fi screen.

**iOS 10 (example of English version)**

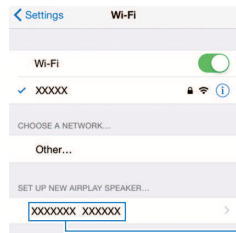

The name of the unit

**5** Select the network (access point) of which you want to share the settings with the unit.

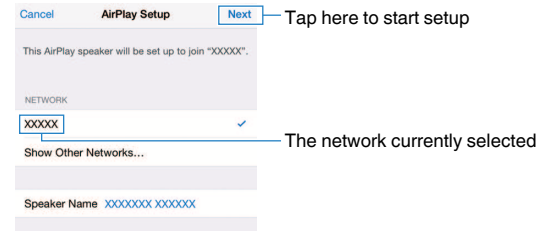

When the sharing process finishes, the unit is automatically connected to the selected network (access point) and “Completed” appears on the front display.

If “Not shared” or “Not connected” appears, press ENTER to repeat from step 1 or try another connection method.

**6** Press SETUP.

This completes the network settings.

## Setting up a wireless connection by selecting from the list of available access points

You can set up a wireless connection by selecting an access point from the list of wireless LAN routers (access points) found by the unit. You need to manually enter the security key.

### Setup menu

“Network” > “Network Connection” > “Wireless(Wi-Fi)”

- 1 Use the cursor keys to select “Access Point Scan” and press ENTER.

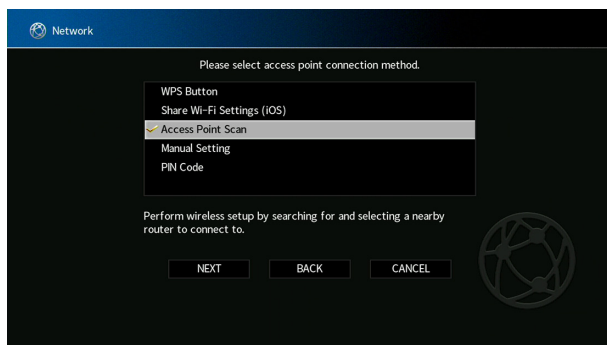

- 2 Use the cursor keys to select “NEXT” and press ENTER.

After searching for access points, the list of available access points appears on the TV.

- 3 Use the cursor keys to select the desired access point and press ENTER.

A check mark is put on the desired access point.

- 4 Use the cursor keys to select “NEXT” and press ENTER.

The edit screen appears.

- 5 Use the cursor keys and ENTER to enter the security key.

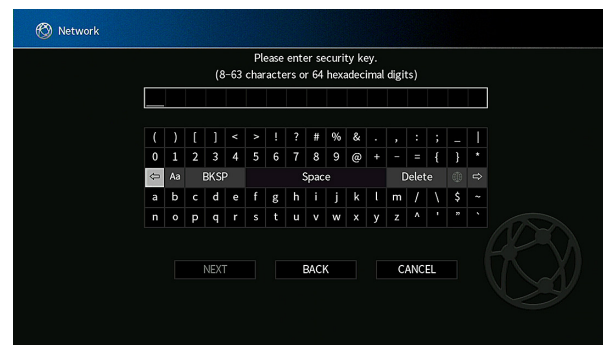

## 6 When finished entering the key, use the cursor keys to select “NEXT” and press ENTER.

The wireless connection setting screen appears on the TV.

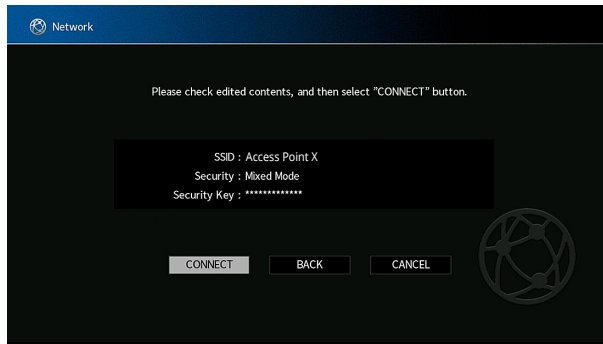

## 7 Use the cursor keys to select “CONNECT” and press ENTER to start the connection process.

When the connection process finishes, “Completed” appears on the TV screen.

If “Not connected” appears, repeat from step 1 or try another connection method.

## 8 Press SETUP.

This completes the network settings.

## Setting up a wireless connection manually

You can set up a wireless connection by entering the required information manually. You need to set up the SSID (network name), encryption method and security key for your network.

### Setup menu

“Network” > “Network Connection” > “Wireless(Wi-Fi)”

### 1 Use the cursor keys to select “Manual Setting” and press ENTER.

### 2 Use the cursor keys to select “NEXT” and press ENTER.

The edit screen appears.

### 3 Use the cursor keys and ENTER to enter the SSID of the access point.

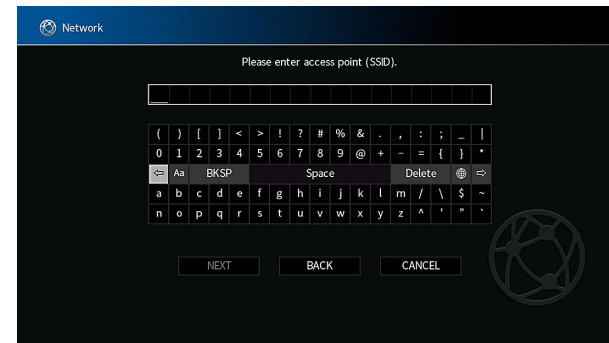

**4** When finished entering the key, use the cursor keys to select “NEXT” and press ENTER.

**5** Use the cursor keys to select the encryption method.

**Choices**

None, WEP, WPA-PSK(AES), Mixed Mode

**Note**

If you select “None”, the connection may be insecure since the communication is not encrypted.

**6** Use the cursor keys to select “NEXT” and press ENTER.

The edit screen appears.

**Note**

If you select “None” in step 5, this item is not available.

**7** Use the cursor keys and ENTER to enter the security key.

**8** When finished entering the key, use the cursor keys to select “NEXT” and press ENTER.

The manual setting screen appears on the TV.

**9** Use the cursor keys to select “CONNECT” and press ENTER to start the connection process.

When the connection process finishes, “Completed” appears on the TV screen.

If “Not connected” appears, check that all the information is entered correctly, and repeat from step 1.

**10** Press SETUP.

This completes the network settings.

## Setting up a wireless connection by using the WPS PIN code

---

You can set up a wireless connection by entering the unit's PIN code into the wireless router (access point). The method is available if the wireless router (access point) supports the WPS PIN code method.

### Setup menu

"Network" > "Network Connection" > "Wireless(Wi-Fi)"

**1 Use the cursor keys to select "PIN Code" and press ENTER.**

**2 Use the cursor keys to select "NEXT" and press ENTER.**

The list of available access points appears on the TV.

**3 Use the cursor keys to select the desired access point and press ENTER.**

**4 Use the cursor keys to select "NEXT" and press ENTER.**

The PIN code of the unit appears on the TV screen.

**5 Enter the unit's PIN code into the wireless router (access point).**

For details on settings, refer to the instruction manual of the wireless router (access point).

**6 Use the cursor keys to select "CONNECT" and press ENTER to start the connection process.**

When the connection process finishes, "Completed" appears on the TV screen.

If "Not connected" appears, repeat from step 1 or try another connection method.

**7 Press SETUP.**

This completes the network settings.

# Input/output jacks and cables

## Video/audio jacks

### HDMI jacks

Transmit digital video and digital sound through a single jack. Use an HDMI cable.

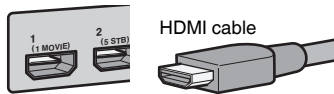

#### Note

- Use a 19-pin HDMI cable with the HDMI logo. We recommend using a cable less than 5.0 m (16.4 ft) long to prevent signal quality degradation.
- The unit's HDMI jacks support the HDMI Control, Audio Return Channel (ARC), and 3D and 4K Ultra HD video transmission (through output) features.
- Use a Premium High Speed HDMI Cable or Premium High Speed Cable with Ethernet to enjoy 3D or 4K Ultra HD videos.

## Video jacks

### COMPONENT VIDEO jacks

Transmit video signals separated into three components: luminance (Y), chrominance blue (Pb), and chrominance red (Pr). Use a component video cable with three plugs.

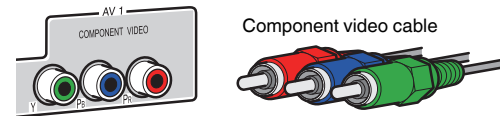

### VIDEO jacks

Transmit analog video signals. Use a video pin cable.

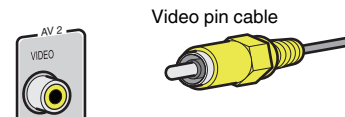



## Audio jacks

---

### ■ OPTICAL jack

Transmit digital audio signals. Use a digital optical cable. If there is a protective cap on the tip of the cable, remove it before using the cable.

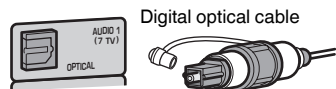

### ■ COAXIAL jacks

Transmit digital audio signals. Use a digital coaxial cable.



### ■ AUDIO jacks

Transmit analog stereo audio signals.

#### (Stereo L/R jacks)

Use a stereo pin cable (RCA cable).

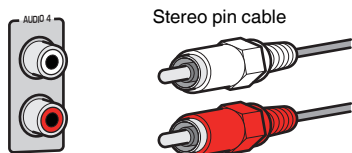

#### (Stereo mini jack)

Use a stereo mini-plug cable.

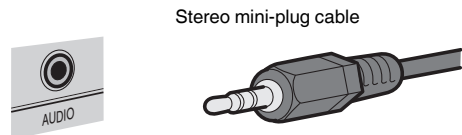

## Using presence speakers

### Presence speaker layout

The following three layout patterns are available for the presence speakers. Choose a layout pattern that suits your listening environment.

- Front Height
- Overhead
- Dolby Enabled SP

#### Note

- You can enjoy Dolby Atmos, DTS:X or Cinema DSP 3D with any layout pattern.
- When using presence speakers, configure the “Layout” setting in the “Setup” menu before automatically optimizing the speaker settings (YPAO). For details, see the following:
  - “Setting the layout of the presence speakers” (p.97)

### Installing the presence speakers in Front Height position

Install the presence speakers on the front wall (Front Height).

It delivers a natural sound field with excellent linkage of left, right, top and bottom sound spaces, and sound extensity effectively.

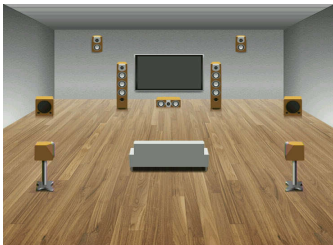

### Installing the presence speakers in Overhead position

Install the presence speakers to the ceiling above the listening position (Overhead). It delivers realistic overhead sound effects and sound field with excellent linkage of front and rear sound spaces effectively.



#### Caution

- Be sure to use speakers that are made for ceiling use and take anti-drop measures. Ask a qualified contractor or dealer personnel for installation works.

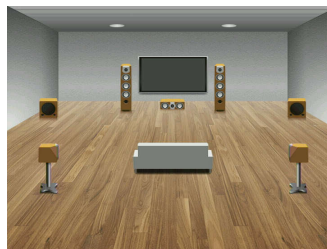

#### Note

When installing presence speakers to a ceiling, install them just above the listening position, or the ceiling between the extensions of the front speakers and listening position.

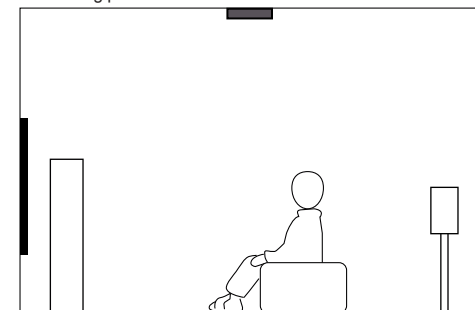
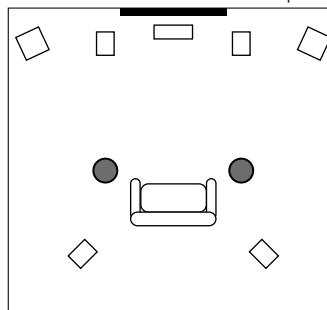

## Using Dolby Enabled speakers as the presence speakers

---

Use Dolby Enabled speakers as the presence speakers.

This utilizes sound reflected from ceiling and lets you enjoy overhead sound only from speakers that are placed at the same level as traditional speakers.

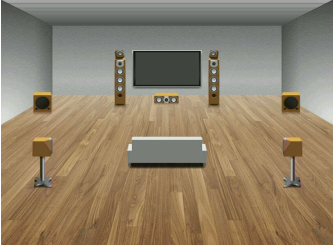

### Note

- Place the Dolby Enabled speakers on top of or near the traditional front speakers.
- A Dolby Enabled speaker unit may be integrated into a traditional speaker. For details, refer to the instruction manual of the Dolby Enabled speakers.

## Glossary of audio information

### Glossary of audio decoding format

This is a glossary of the technical terms related to audio decoding format used in this manual.

#### Dolby Atmos

Introduced first in the cinema, Dolby Atmos brings a revolutionary sense of dimension and immersion to the Home Theater experience. Dolby Atmos is an adaptable and scalable object based format that reproduces audio as independent sounds (or objects) that can be accurately positioned and move dynamically throughout the 3 dimensional listening space during playback. A key ingredient of Dolby Atmos is the introduction of a height plane of sound above the listener.

#### Dolby Atmos Stream

Dolby Atmos content will be delivered to your Dolby Atmos enabled AV receiver via Dolby Digital Plus or Dolby TrueHD on Blu-ray Disc, downloadable files and streaming media. A Dolby Atmos stream contains special metadata that describes the positioning of sounds within the room. This object audio data is decoded by a Dolby Atmos AV receiver and scaled for optimum playback through Home Theater speaker systems of every size and configuration.

#### Dolby Digital

Dolby Digital is a compressed digital audio format developed by Dolby Laboratories, Inc. that supports 5.1-channel audio. This technology is used for audio on most DVD disc.

#### Dolby Digital Plus

Dolby Digital Plus is a compressed digital audio format developed by Dolby Laboratories, Inc. that supports 7.1-channel audio. Dolby Digital Plus remains fully compatible with the existing multichannel audio systems that support Dolby Digital. This technology is used for audio streaming services on the Internet and audio on BD (Blu-ray Disc).

#### Dolby Enabled Speaker

A convenient alternative to speakers built into the ceiling, products utilizing Dolby speaker technology employ the ceiling above you as a reflective surface for reproducing audio in the height plane above the listener. Dolby enabled speakers feature a unique upward firing driver and special signal processing that can be built into a conventional speaker, or a standalone speaker module, minimally impacting the overall speaker system footprint while providing an immersive listening experience during Dolby Atmos and Dolby surround playback.

#### Dolby Surround

Dolby surround is a next generation surround technology that intelligently up mixes stereo; 5.1 and 7.1 content for playback through your surround speaker system. Dolby surround is compatible with traditional speaker layouts, as well as Dolby Atmos enabled playback systems that employ in-ceiling speakers or products with Dolby speaker technology.

#### Dolby TrueHD

Dolby TrueHD is an advanced lossless audio format developed by Dolby Laboratories, Inc. to offer a high-definition home theater experience with the quality of the studio master. Dolby TrueHD can carry up to eight channels of 96 kHz/24-bit audio (up to six channels of 192 kHz/24-bit audio) simultaneously. This technology is used for audio on BD (Blu-ray Disc).

#### DTS 96/24

DTS 96/24 is a compressed digital audio format that supports 5.1-channel and 96 kHz/24-bit audio. This format remains fully compatible with the existing multichannel audio systems that support DTS Digital Surround. This technology is used for music DVDs, etc.

#### DTS Dialog Control

DTS Dialog Control allows you to boost the dialog. This can be useful in noisy environments to help make the dialog more intelligible. People with impaired hearing may also benefit. Note that the content creator may disable the use of this feature in the mix, so that DTS Dialog Control may not always be available. Note that updates to your AVR may add more functionality to DTS Dialog Control or increase the range of the feature.

#### DTS Digital Surround

DTS Digital Surround is a compressed digital audio format developed by DTS, Inc. that supports 5.1-channel audio. This technology is used for audio on most DVD discs.

#### DTS-ES

DTS-ES creates total 6.1-channel audio from 5.1-channel sources that are recorded with DTS-ES. This decoder adds a surround back sound to the original 5.1-channel sound. In the DTS-ES Matrix 6.1 format, a surround back sound is recorded in the surround channels, and in the DTS-ES Discrete 6.1 format, a discrete surround back channel is recorded.

#### DTS Express

DTS Express is a compressed digital audio format that supports 5.1-channel audio and allows a higher compression rate than the DTS Digital Surround format developed by DTS, Inc. This technology is developed for audio streaming services on the Internet and secondary audio on BD (Blu-ray Disc).

#### DTS-HD High Resolution Audio

DTS-HD High Resolution Audio is a compressed digital audio format developed by DTS, Inc. that supports 7.1-channel and 96 kHz/24-bit audio. DTS-HD High Resolution Audio remains fully compatible with the existing multichannel audio systems that support DTS Digital Surround. This technology is used for audio on most BD (Blu-ray Disc).

#### DTS-HD Master Audio

DTS-HD Master Audio is an advanced lossless audio format developed to offer a high-definition home theater experience with the quality of the studio master by DTS, Inc. DTS-HD Master Audio can carry up to eight channels of 96 kHz/24-bit audio (up to six channels of 192 kHz/24-bit audio) simultaneously. This technology is used for audio on BD (Blu-ray Disc).

#### DTS Neo: 6

DTS Neo: 6 enables 6-channel playback from 2-channel sources. There are two modes available: "Music mode" for music sources and "Cinema mode" for movie sources. This technology provides discrete full-bandwidth matrix channels of surround sound.

## **DTS:X**

DTS:X is the next generation object-based, multi-dimensional audio technology from DTS. Unbound from channels, DTS:X conveys the fluid movement of sound to create an incredibly rich, realistic and immersive soundscape - in front of, behind, beside and above the audience - more accurately than ever before. DTS:X offers the ability to automatically adapt the audio to the speaker layout that best fits the space, from a television's built-in speakers to a home surround theater system to a dozen or more speakers in a commercial cinema. Immerse yourself at [www.dts.com/dtsx](http://www.dts.com/dtsx)

## **DSD (Direct Stream Digital)**

DSD (Direct Stream Digital) technology stores audio signals on digital storage media, such as SACD (Super Audio CDs). The signals are stored at a high-frequency sampling rate (such as 11.2 MHz). The highest frequency response is equal to or higher than 100 kHz, with a dynamic range of 120 dB. This technology offers better audio quality than that used for CDs.

## **FLAC**

FLAC is a file format for lossless audio data compression. FLAC is inferior to lossy compressed audio formats in compression rate but provides higher audio quality.

## **MP3**

One of the compressed digital audio format used by MPEG. With psychoacoustic technologies, this compression method achieves a high compression rate. Reportedly, it is capable of compressing data quantity by about 1/10 maintaining a certain level of audio quality.

## **MPEG-4 AAC**

An MPEG-4 audio standard. It is used for mobile telephones, portable audio players, and audio streaming services on Internet because it allows a high compression rate of data while maintaining better audio quality than MP3.

## **Neural:X**

Neural:X is the latest downmixing/upmixing and spatial remapping technology from DTS. It is built in to DTS:X to provide upmix of Neural:X-encoded and non-encoded (PCM) data. In DTS:X for AVRs and Sound Bars, Neural:X can produce up to 11.x channels.

## **PCM (Pulse Code Modulation)**

PCM is a signal format under which an analog audio signal is digitized, recorded, and transmitted. This technology is the basis of all other audio format. This technology is used as a lossless audio format called Linear PCM for audio on a variety of media, including CDs.

## **Sampling frequency/Quantization bit**

Sampling frequency and quantization bits indicate the quantity of information when an analog audio signal is digitized. These values are noted as in the following example: "48 kHz/24-bit".

- **Sampling frequency**  
Sampling frequency (the number of times the signal is sampled per second) is called the sampling rate. When the sampling frequency is higher, the range of frequencies that can be played back are wider.
- **Quantization bit**  
The number of quantization bits indicate the degree of accuracy when converting the sound level into a numeric value. When the number of quantized bits is higher, the expression of the sound level is more accurate.

## **WAV**

Windows standard audio file format, which defines the method of recording the digital data obtained by converting audio signals. By default, the PCM method (no compression) is used, but you can also use other compression methods.

## **WMA (Windows Media Audio)**

One of the compressed digital audio formats developed by Microsoft Corporation. With psychoacoustic technologies, this compression method achieves a high compression rate. Reportedly, it is capable of compressing data quantity by about 1/20 maintaining a certain level of audio quality.

# **Glossary of audio information other than audio decoding format**

This is a glossary of the technical terms related to audio information used in this manual.

## **Bi-amplification connection (Bi-amp)**

A bi-amplification connection uses two amplifiers for a speaker. When you use the bi-amplification connection, the unit drives the tweeter and woofer in a speaker with the discrete amplifiers. As a consequence, the tweeter and woofer provide clear audio signal without the interference.

## **LFE (Low Frequency Effects) 0.1 channel**

This channel reproduces low-frequency bass signals and has a frequency range from 20 Hz to 120 Hz. This channel is added to the channels for all bands with Dolby Digital or DTS to enhance low frequency audio effects. This channel is labeled 0.1 because it is limited to only low frequency audio.

## **Lip sync**

Video output sometimes lags behind audio output due to the complexity of signal processing caused by an increase in video signal capacity. Lip sync is a technique for automatically correcting the timing lag between audio and video output.

# **Glossary of HDMI and video information**

This is a glossary of the technical terms related to HDMI and video information used in this manual.

## **Component video signal**

With the component video signal system, the video signal is separated into the Y signal for luminance and the Pb and Pr signals for chrominance. Color can be reproduced more faithfully with this system because each of these signals is independent.

## **Composite video signal**

With the composite video signal system, color, brightness, and synchronization data signals are combined and transmitted with a single cable.

## Deep Color

Deep Color is a technology that HDMI specification supports. Deep Color increases the number of available colors within the boundaries defined by the RGB or YCbCr color space. Conventional color systems process the color using 8 bits. Deep Color processes the color with 10, 12, or 16 bits. This technology allows HDTVs and other displays to increase from millions of colors to billions of colors and eliminate on-screen color banding for smooth tonal transitions and subtle gradations between colors.

## HDCP

HDCP (High-bandwidth Digital Content Protection) is a digital copy protection form that prevents copying of digital contents as it travels across connections (such as HDMI).

## HDMI

HDMI (High-Definition Multimedia Interface) is the world-wide standard interface for digital audio/video signal transmission. This interface transmits both digital audio and digital video signals using a single cable without any loss. HDMI complies with HDCP (High-bandwidth Digital Content Protection) and provides a secure audio/video interface. For further information on HDMI, visit the HDMI website at "<http://www.hdmi.org/>".

## x.v.Color

"x.v.Color" is a technology that the HDMI specification supports. It is a more extensive color space than sRGB and allows the expression of colors that were not hitherto possible. While remaining compatible with the color gamut of sRGB standards, "x.v.Color" expands the color space, and thus can produce more vivid, natural images.

## Glossary of network information

---

This is a glossary of the technical terms related to network information used in this manual.

### SSID

SSID (Service Set Identifier) is a name that identifies a particular wireless LAN access point.

### Wi-Fi

Wi-Fi (Wireless Fidelity) is a technology that allows an electronic device to exchange data or connect to the Internet wirelessly using radio waves. Wi-Fi offers the advantage of eliminating the complexity of making connections with LAN cables by using wireless connection. Only products that complete Wi-Fi Alliance interoperability tests can carry the "Wi-Fi Certified" trademark.

### WPS

WPS (Wi-Fi Protected Setup) is a standard established by the Wi-Fi Alliance, which allows easy establishment of a wireless home network.

## Glossary of Yamaha technologies

---

This is a glossary of the technical terms related to Yamaha technologies used in this manual.

### CINEMA DSP (Digital Sound Field Processor)

Since the surround sound systems were originally designed for use in movie theaters, their effect is best experienced in a theater that has many speakers designed for acoustic effects. Since home conditions (such as room size, wall material, and number of speakers) can differ so widely, it is inevitable that there are differences in the sound that you hear. Based on a wealth of actually measured data, CINEMA DSP, Yamaha's original DSP technology provides the audiovisual experience of a movie theater in your own home.

### CINEMA DSP 3D

The actually measured sound field data contain the information of the height of the sound images. CINEMA DSP 3D mode achieves the reproduction of the accurate height of the sound images so that it creates the accurate and intensive 3D sound fields in a listening room.

### Compressed Music Enhancer

The Compressed Music Enhancer feature compensates for missing harmonics in compression music formats (such as MP3). As a result, this technology provides improved performance for the overall sound system.

### SILENT CINEMA

Yamaha has developed a natural, realistic sound effect DSP algorithm for headphones. Parameters for headphones have been set for each sound program, so that accurate representations of all the sound programs can be enjoyed on headphones.

### Virtual CINEMA DSP

Virtual CINEMA DSP allows the system to virtually reproduce the sound field of the surround speakers with front left and right speakers. Even if the surround speakers are not connected, the unit creates the realistic sound field in a listening room.

### **Virtual CINEMA FRONT**

Virtual CINEMA FRONT allows the system to virtually reproduce the sound field of the surround speakers with front surround speakers. Even if the surround speakers placed in the front, the unit creates the realistic sound field in a listening room.

### **Virtual Presence Speaker (VPS)**

Virtual Presence Speaker allows the system to virtually reproduce the height of the 3D sound field without presence speakers. Even if the presence speakers are not connected, the unit creates the 3D sound field in your room.

### **Virtual Surround Back Speaker (VSBS)**

Virtual Surround Back Speaker allows the system to virtually reproduce the sound field of the surround back speakers with surround speaker. Even if the surround back speakers are not connected, the unit adds a sense of depth to the rear sound field of CINEMA DSP.

### **YPAO (Yamaha Parametric room Acoustic Optimizer)**

The Yamaha Parametric room Acoustic Optimizer (YPAO) function detects speaker connections, measures the distances from them to your listening position(s), and then automatically optimizes the speaker settings, such as volume balance and acoustic parameters, to suit your room.

## Supported devices and file formats

### Supported Bluetooth® devices

The following Bluetooth devices can be used by the unit.

- Bluetooth devices that support A2DP can be used.
- Operation of all Bluetooth devices cannot be guaranteed.

### Supported USB devices

The following USB devices can be used by the unit.

- This unit is compatible with USB memory devices that are in FAT16 or FAT32 format.  
Do not connect any other type of USB devices.
- USB devices with encryption cannot be used.
- Operation of all USB devices cannot be guaranteed.

### Supported AirPlay devices

AirPlay works with iPhone, iPad, and iPod touch with iOS 4.3.3 or later, Mac with OS X Mountain Lion or later, and PC with iTunes 10.2.2 or later.

#### **Made for.**

iPhone 7 Plus, iPhone 7, iPhone SE, iPhone 6s Plus, iPhone 6s, iPhone 6 Plus, iPhone 6, iPhone 5s, iPhone 5c, iPhone 5, iPhone 4s

iPad Pro (10.5"), iPad Pro (12.9") 2nd Generation, iPad Pro (12.9") 1st Generation, iPad Pro (9.7"), iPad mini 4, iPad Air 2, iPad mini 3, iPad Air, iPad mini 2, iPad mini, iPad (5th generation), iPad (4th generation), iPad (3rd generation), iPad 2

iPod touch (6th generation), iPod touch (5th generation)

(as of February 2018)

## Supported file formats

The following file formats can be used by the unit.

File	Sampling frequency (kHz)	Quantization bit (bit)	Bitrate (kbps)	Number of channels	Support for gapless playback
WAV *	32/44.1/48/ 88.2/96/ 176.4/192	16/24/32	-	2	✓
MP3	32/44.1/48	-	8 to 320	2	-
WMA	32/44.1/48	-	8 to 320	2	-
MPEG-4 AAC	32/44.1/48	-	8 to 320	2	-
FLAC	32/44.1/48/ 88.2/96/ 176.4/192	16/24	-	2	✓
ALAC	32/44.1/48/ 88.2/96	16/24	-	2	✓
AIFF	32/44.1/48/ 88.2/96/ 176.4/192	16/24/32	-	2	✓
DSD	2.8 MHz/ 5.6 MHz/ 11.2 MHz	1	-	2	-

\* Linear PCM format only. 32 bit-float files cannot be played back.

- The playable file formats differ depending on the software installed on media servers (PCs/NAS). Refer to the instruction manual of the server software for details.
- Digital Rights Management (DRM) contents cannot be played back.

## Video signal flow

### Video signal flow

Video signals input from a video device to the unit are output to a TV as follows.

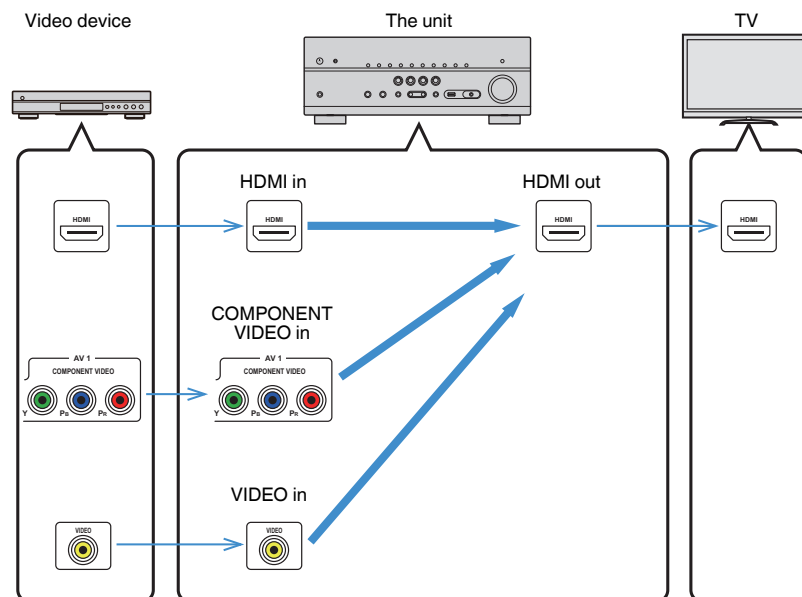



## Video conversion table

Video conversion table is shown as follows.

### Note

- You can select the resolution and the aspect ratio applied to HDMI-output video processing in “Video Mode” in the “Setup” menu. For details, see the following:
  - “Setting the use of the video signal processing” (p.113)
- The unit does not convert 480-line and 576-line video signals interchangeably.

	Resolution	HDMI out					
		480i/ 576i	480p/ 576p	720p	1080i	1080p	4K
HDMI in	480i/576i	→	→	→	→	→	→
	480p/576p		→	→	→	→	→
	720p			→	→	→	→
	1080i			→	→	→	→
	1080p/50, 60 Hz			→	→	→	→
	1080p/24 Hz					→	→
	4K						→
COMPONENT VIDEO in	480i/576i	→	→	→	→	→	→
VIDEO in	480i/576i	→	→	→	→	→	→

→ : Available

## Additional information on HDMI

### HDMI Control and synchronized operations

HDMI Control allows you to operate external devices via HDMI. If you connect a TV that supports HDMI Control to the unit with an HDMI cable, you can control the unit (such as power and volume) with TV remote control operations. You can also control external devices (such as HDMI Control-compatible BD/DVD players) connected to the unit with an HDMI cable.

#### Operations available from the TV's remote control

- Standby
- Volume control including mute
- Switching to input audio from the TV when the TV input is switched to its built-in tuner
- Switching to input video/audio from the selected playback device
- Switching between audio output devices (the unit or TV speaker)

#### (Example)

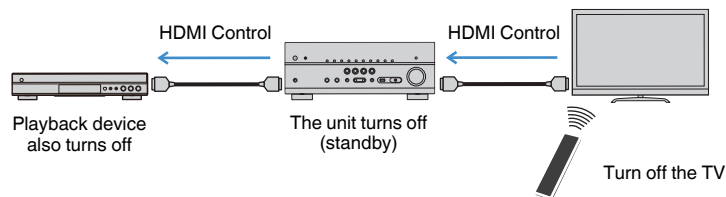

#### Operations available from the unit's remote control

- Starting playback on the playback device and turning on the TV with a scene selection
- Switching the TV input to display the "Setup" menu (when SETUP is pressed)
- Controlling the external device from which video is displayed on the TV (playback and menu operations)
- Controlling the TV when you select TV audio input that is set in "TV Audio Input" in the "Setup" menu
- Controlling the TV with the color (RED/GREEN/YELLOW/BLUE) keys of the remote control when "TV Control" is set for the color keys

#### (Example)

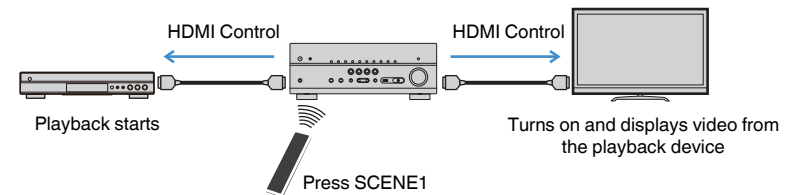

#### Note

- HDMI Control might not work properly.
- For details on the scene selection, see the following:
  - "Selecting a registered scene" (p.73)
- For details on TV audio input, see the following:
  - "Setting the audio jack used for TV audio input" (p.114)
- For details on the functions for the RED/GREEN/YELLOW/BLUE keys, see the following:
  - "Setting the unit's functions for the RED/GREEN/YELLOW/BLUE keys of the remote control" (p.130)

To use HDMI Control, you need to perform the following HDMI Control link setup after connecting the TV and playback devices.

For details on settings and operating your TV, refer to the instruction manual for the TV.

#### Note

This setup is required every time you add a new HDMI Control-compatible device to your system.

- 1 Turn on the unit, TV, and playback devices.**
- 2 Enable the HDMI Control function on the unit, TV and HDMI Control-compatible playback devices (such as BD/DVD players).**

In order to enable the HDMI Control function on the unit, set "HDMI Control" in the "Setup" menu to "On", and then configure the settings in related items ("TV Audio Input", "Standby Sync" and "ARC"). For details, see the following:

- "Setting the use of HDMI Control" (p.114)

- 3 Turn off the main power of the TV and then turn off the unit and playback devices.**

- 4 Turn on the unit and playback devices and then turn on the TV.**
- 5 Switch the TV input to display the video from the unit.**
- 6 Check that the input, to which the playback device is connected on the unit, is selected.**  
If not, select the input source manually.
- 7 Check that the video from the playback device is displayed on the TV.**
- 8 Check that the unit is properly synchronized with the TV by turning off the TV or adjusting the TV volume with the TV remote control.**

#### Note

- If HDMI Control does not work properly, the problem may be solved by turning the playback device off and on again, or by unplugging the power plug and plugging it in again. Also, HDMI Control may not work properly if the number of connected devices exceeds the limit. In this case, disable HDMI Control on devices not in use.
- If the unit is not synchronized to the TV's power operations, check the priority of the audio output setting on the TV.
- We recommend using TV and playback devices from the same manufacturer so that HDMI Control works more effectively.

## Audio Return Channel (ARC)

ARC allows you to input TV audio to the unit with the HDMI cable which transmits video signal to the TV.

Check the following after the HDMI Control settings.

#### Note

For details on the HDMI Control settings, see the following:

- "HDMI Control and synchronized operations" (p.170)

- 1 Select a TV program with the TV remote control.**
- 2 Check that the input source of the unit will be automatically switched to "AUDIO1" and the TV audio will be played back on the unit.**

If you cannot hear the TV audio, check the following:

- "ARC" in the "Setup" menu is set to "On". For details, see the following:
  - "Setting the use of ARC" (p.114)
- The HDMI cable is connected to the ARC-compatible HDMI jack (HDMI jack marked "ARC") on the TV.

Some HDMI jack on the TV is not compatible with ARC. For details, refer to the instruction manual for the TV.

#### Note

- If the audio is interrupted while using ARC, set "ARC" in the "Setup" menu to "Off" and use a digital optical cable to input TV audio to the unit. For details, see the following:
  - "Setting the use of ARC" (p.114)
  - "OPTICAL jack" (p.161)
- When using ARC, connect a TV with an HDMI cable that supports ARC.
- "AUDIO1" is set as TV audio input at the factory. If you have connected any external device to the AUDIO 1 jacks, use "TV Audio Input" in the "Setup" menu to change the TV audio input assignment. To use the SCENE function, you also need to change the input assignment for SCENE (7). For details, see the following:
  - "Setting the audio jack used for TV audio input" (p.114)
  - "Registering a scene" (p.75)

## HDMI signal compatibility

---

Confirm the following HDMI signal used by the unit.

- When CPPM copy-protected DVD-Audio is played back, video/audio signals may not be output, depending on the type of the DVD player.
- The unit is not compatible with HDCP-incompatible HDMI or DVI devices. For details, refer to the instruction manual for each device.
- To decode audio bitstream signals on the unit, set the playback device appropriately so that the device outputs the bitstream audio signals directly (does not decode the bitstream signals on the playback device). For details, refer to the instruction manual for the playback device.
- If the playback device can decode the bitstream audio signals of audio commentaries, you can play back the audio sources with the audio commentaries mixed down by using digital audio input (OPTICAL or COAXIAL jacks). For details, refer to the instruction manual for the playback device. The unit is not compatible with audio commentaries for BD, such as audio content downloaded from the internet.

# Trademarks

## Trademarks

The trademarks used in this manual are as follows.



Manufactured under license from Dolby Laboratories. Dolby, Dolby Atmos, Dolby Surround, Dolby Vision, and the double-D symbol are trademarks of Dolby Laboratories.



For DTS patents, see <http://patents.dts.com>. Manufactured under license from DTS, Inc. DTS, the Symbol, DTS in combination with the Symbol, DTS:X, and the DTS:X logo are registered trademarks or trademarks of DTS, Inc. in the United States and/or other countries. © DTS, Inc. All Rights Reserved.



Supports iOS 7 or later for setup using Wireless Accessory Configuration.

"Made for iPod," "Made for iPhone," and "Made for iPad" mean that an electronic accessory has been designed to connect specifically to iPod, iPhone, or iPad, respectively, and has been certified by the developer to meet Apple performance standards.

Apple is not responsible for the operation of this device or its compliance with safety and regulatory standards.

Please note that the use of this accessory with iPod, iPhone, or iPad may affect wireless performance.

iTunes, AirPlay, iPad, iPhone, iPod, and iPod touch are trademarks of Apple Inc., registered in the U.S. and other countries.

iPad Air and iPad mini are trademarks of Apple Inc.

App Store is a service mark of Apple Inc.



The terms HDMI, the HDMI Logo, and High-Definition Multimedia Interface are trademarks or registered trademarks of HDMI Licensing LLC in the United States and other countries.

### x.v.Color™

"x.v.Color" is a trademark of Sony Corporation.

### Windows™

Windows is a registered trademark of Microsoft Corporation in the United States and other countries.

Internet Explorer, Windows Media Audio and Windows Media Player are either registered trademarks or trademarks of Microsoft Corporation in the United States and/or other countries.

### Android™

### Google Play™

Android and Google Play are trademarks of Google Inc.



The Wi-Fi CERTIFIED™ Logo and Wi-Fi Protected Setup are certification marks of Wi-Fi Alliance®.

Wi-Fi, Wi-Fi CERTIFIED, Wi-Fi Protected Setup and WPA2 are registered trademarks or trademarks of Wi-Fi Alliance®.



The Bluetooth® word mark and logos are registered trademarks owned by Bluetooth SIG, Inc. and any use of such marks by Yamaha Corporation is under license.

### SILENT™ CINEMA

"SILENT CINEMA" is a trademark of Yamaha Corporation.



MusicCast is a trademark or registered trademark of Yamaha Corporation.



Yamaha Eco-Label is a mark that certifies products of high environmental performance.

### Google Noto Fonts

This product uses the following fonts.

Copyright © June 2015, Google (<https://www.google.com/get/noto/#sans-lgc>), with Reserved Font Name Noto Sans Version 1.004.

Copyright © June 2015, Google (<https://www.google.com/get/noto/help/cjk/>), with Reserved Font Name Noto Sans CJK Version 1.004.

This Font Software is licensed under the SIL Open Font License, Version 1.1.

This license is available with a FAQ at: <http://scripts.sil.org/OFL>

### Explanations regarding GPL

This product utilizes GPL/LGPL open-source software in some sections. You have the right to obtain, duplicate, modify, and redistribute this open-source code only. For information on GPL/LGPL open source software, how to obtain it, and the GPL/LGPL license, refer to the Yamaha Corporation website (<http://download.yamaha.com/sourcecodes/musiccast/>).

### Licenses

For information on the licenses of the third-party software in this product, refer to the following.

[http://\(IP address of this product\)/licenses.html](http://(IP address of this product)/licenses.html)

\* IP address of this product is checked with MusicCast CONTROLLER.

## Specifications

The specifications of this unit are as follows.

### Input jacks

Analog Audio

- Audio x 5 (including PHONO, AUX)

Digital Audio (Supported frequencies: 32 kHz to 96 kHz)

- Optical x 2
- Coaxial x 2

Video

- Component x 1
- Composite x 1

HDMI Input

- HDMI x 5

Other jacks

- USB x 1 (USB2.0)
- NETWORK (Wired) x 1 (100Base-TX/10Base-T)

### Output jacks

Analog Audio

- Speaker Out x 9 (7 ch) (FRONT L/R, CENTER, SURROUND L/R, EXTRA SP 1 L/R\*1, EXTRA SP 2 L/R\*2)

\*1 Note: Assignment is possible [F.PRESENCE, ZONE2]

\*2 Note: Assignment is possible [SURROUND BACK, ZONE2, BI-AMP]

- Pre Out x 2 (FRONT L/R)
- Subwoofer Out x 2 (mono x 2)
- ZONE2 OUT x 2 (L/R)
- Headphone x 1

HDMI Output

- HDMI OUT x 2

### Other jacks

- YPAO MIC x 1
- REMOTE IN x 1
- REMOTE OUT x 1
- TRIGGER OUT x 1

### HDMI

HDMI Features:

- 4K UltraHD Video (include 4K/60, 50Hz 10/12bit), 3D Video, ARC (Audio Return Channel), HDMI Control (CEC), Auto Lip Sync, Deep Color, "x.v.Color", HD audio playback, Selectable HDMI input in HDMI standby mode, 21:9 Aspect Ratio, BT.2020 Colorimetry, HDR Compatible

Video Format (Repeater Mode)

- VGA
- 480i/60 Hz
- 576i/50 Hz
- 480p/60 Hz
- 576p/50 Hz
- 720p/60 Hz, 50 Hz
- 1080i/60 Hz, 50 Hz
- 1080p/60 Hz, 50 Hz, 30 Hz, 25 Hz, 24 Hz
- 4K/60Hz, 50Hz, 30 Hz, 25 Hz, 24 Hz

Audio Format

- Dolby Atmos
- Dolby TrueHD
- Dolby Digital Plus
- Dolby Digital
- DTS:X
- DTS-HD Master Audio
- DTS-HD High Resolution Audio
- DTS Express
- DTS
- DSD 2-ch to 6-ch (2.8 MHz)
- PCM 2-ch to 8-ch (Max. 192 kHz/24-bit)

Content Protection: HDCP 2.2 compatible

Link Function: CEC supported

## TUNER

Analog Tuner

- [U.K., Europe, Russia and Middle East models]  
FM/AM with Radio Data System x 1 (TUNER)
- [Other models]  
FM/AM x 1 (TUNER)

## USB

Capable of Mass Storage Class USB Memory

Current Supply Capacity: 1.0 A

## Bluetooth

Sink Function

- Source Device to AVR (ex. Smartphone/Tablet)
- Supported profile
  - A2DP, AVRCP
- Supported codec
  - SBC, AAC

Bluetooth version

- Ver. 4.2

Wireless output

- Bluetooth Class 2

Maximum communication distance

- 10 m (33 ft) without interference

## Network

PC Client Function

AirPlay supported

Internet Radio

Wi-Fi function

- Capable of WPS by PIN Method and Push-Button-Method
- Capable of sharing with iOS devices by wireless connection
- Available Security Method: WEP, WPA2-PSK (AES), Mixed Mode, None
- Wireless LAN Standards: IEEE 802.11 a/b/g/n/ac\*  
\* 20 MHz channel bandwidth only

## Compatible Decoding Formats

Decoding Format

- Dolby Atmos
- Dolby TrueHD, Dolby Digital Plus
- Dolby Digital
- DTS:X
- DTS-HD Master Audio, DTS-HD High Resolution Audio, DTS Express
- DTS, DTS 96/24, DTS-ES Matrix 6.1, DTS-ES Discrete 6.1

Post Decoding Format

- Dolby Surround
- DTS Neo: 6 Music, DTS Neo: 6 Cinema
- Neural:X

## Audio Section

---

Rated Output Power (2-channel driven)

- [All models] (20 Hz to 20 kHz, 0.06% THD, 8 Ω)
  - Front L/R 90 W+90 W
- [U.S.A. and Canada models] (1 kHz, 0.9% THD, 8 Ω)
  - Front L/R 105 W+105 W
  - Center 105 W
  - Surround L/R 105 W+105 W
  - Surround Back L/R 105 W+105 W

---

Rated Output Power (1-channel driven)

- [All models] (1 kHz, 0.9% THD, 8 Ω)
  - Front L/R, Center, Surround L/R, Surround Back L/R 125 W/ch
- [U.K., Europe, Russia and Middle East models] (1 kHz, 0.9% THD, 4 Ω)
  - Front L/R 150 W/ch

---

Maximum Effective Output Power (1-channel driven)

- (1 kHz, 10% THD, 8 Ω)
  - Front L/R, Center, Surround L/R, Surround Back L/R 150 W/ch
- (1 kHz, 10% THD, 6 Ω)
  - Front L/R, Center, Surround L/R, Surround Back L/R 130 W/ch

---

Dynamic Power (IHF)

- Front L/R (8/6/4/2 Ω) 125/165/190/235 W

---

Damping Factor

- Front L/R, 20 Hz to 20 kHz, 8 Ω 100 or more

Input Sensitivity / Input Impedance	
• PHONO (1 kHz, 100 W/8 Ω)	3.5 mV/47 kΩ
• AV 2 etc. (1 kHz, 100 W/8 Ω)	200 mV/47 kΩ
Maximum Input Signal	
• PHONO (1 kHz, 0.1% THD)	60 mV
• AV 2 etc. (1 kHz, 0.5% THD, Effect On)	2.3 V
Output Level / Output Impedance	
• PRE OUT	
– Front L/R	1 V/2.7 kΩ
• SUBWOOFER	1 V/1.2 kΩ
• ZONE2 OUT	470 mV/1.7 kΩ
Maximum Output Level	
• PRE OUT	1.6 V
Headphone Jack Rated Output / Impedance	
• AV 2 etc. (1 kHz, 50 mV, 8 Ω)	100 mV/560 Ω
Frequency Response	
• AV 2 etc. to Front (10 Hz to 100 kHz)	+0/-3 dB
RIAA Equalization Deviation	
• PHONO	0±0.5 dB
Total Harmonic Distortion	
• PHONO to Front (20 Hz to 20 kHz, 10 V)	0.02% or less
• AV 2 etc. to Front (Pure Direct) (20 Hz to 20 kHz, 50 W, 8 Ω)	0.06% or less
Signal to Noise Ratio (IHF-A Network)	
• PHONO (Input Shorted 35 mV, Front Speaker Out)	96 dB or more
• AV 2 etc. (Pure Direct) (Input 1 kΩ Shorted, Speaker Out)	110 dB or more
Residual Noise (IHF-A Network)	
• Front L/R (Speaker Out)	150 μV or less
Channel Separation	
• PHONO (Input Shorted, 1 kHz/10 kHz)	60 dB/55 dB or more
• AV 2 etc. (Input 1 kΩ Shorted, 1 kHz/10 kHz)	70 dB/50 dB or more

Volume Control	
• Main Zone	MUTE, -80 dB to +16.5 dB (0.5 dB Step)
• Zone2	MUTE, -80 dB to +10.0 dB (0.5 dB Step)

Tone Control Characteristics	
• Bass Boost/Cut	±6 dB/0.5 dB Step at 50 Hz
• Bass Turnover	350 Hz
• Treble Boost/Cut	±6 dB/0.5 dB Step at 20 kHz
• Treble Turnover	3.5 kHz

Filter Characteristics (fc=40/60/80/90/100/110/120/160/200 Hz)	
• H.P.F. (Front, Center, Surround, Surround Back)	12 dB/oct.
• L.P.F. (Subwoofer)	24 dB/oct.

## Video Section

Video Signal Type	
	NTSC/PAL/SECAM

Video Signal Level	
• Composite	1 Vp-p/75 Ω
• Component	
– Y	1 Vp-p/75 Ω
– Pb/Pr	0.7 Vp-p/75 Ω

Video Maximum Input Level	
	1.5 Vp-p or more

## FM Section

Tuning Range	
• [U.S.A. and Canada models]	87.5 MHz to 107.9 MHz
• [Asia, Taiwan, Brazil, General, and Central and South America models]	87.5/87.50 MHz to 108.0/108.00 MHz
• [U.K. and Europe models]	87.50 MHz to 108.00 MHz
• [Other models]	87.50 MHz to 108.00 MHz

50 dB Quiet Sensitivity (IHF, 1 kHz, 100% MOD.)	
• Monaural	3 μV (20.8 dBf)



Signal to Noise Ratio (IHF)	
• Monaural	69 dB
• Stereo	67 dB
Harmonic Distortion (IHF, 1 kHz)	
• Monaural	0.5%
• Stereo	0.6%
Antenna Input	
	75 $\Omega$ unbalanced

## AM Section

Tuning Range	
• [U.S.A. and Canada models]	530 kHz to 1710 kHz
• [Asia, Taiwan, Brazil, General, and Central and South America models]	530/531 kHz to 1710/1611 kHz
• [U.K. and Europe models]	531 kHz to 1611 kHz
• [Other models]	531 kHz to 1611 kHz

## General

Power Supply	
• [U.S.A. and Canada models]	AC 120 V, 60 Hz
• [Brazil and Central and South America models]	AC110 to 120/220 to 240 V, 50/60 Hz
• [Taiwan model]	AC110 to 120 V, 50/60 Hz
• [China model]	AC 220 V, 50 Hz
• [Korea model]	AC 220 V, 60 Hz
• [Australia model]	AC 240 V, 50 Hz
• [UK, Europe, Russia and Middle East models]	AC 230 V, 50 Hz
• [Asia and General models]	AC 220 to 240 V, 50/60 Hz

Power Consumption	
• [U.S.A. and Canada models]	400 W
• [Asia, Taiwan, Brazil, Central and South America and General models]	270 W
• [Other models]	300 W

Standby Power Consumption	
• HDMI Control Off, Standby Through Off	0.1 W
• HDMI Control On, Standby Through On (No Signals)	0.8 W
• HDMI Control On, Standby through AUTO (HDMI no signal and no CEC for 8 hours)	0.4 W
• Network Standby On	
– Wired	1.3 W
– Wireless (Wi-Fi)	1.4 W
– Bluetooth	1.4 W
• HDMI Control On, Standby Through On, Network Standby On	
– Wireless (Wi-Fi)	2.0 W

Maximum Power Consumption	
• [Asia, Taiwan, Brazil, Central and South America and General models]	590 W

Dimensions (W x H x D)	
	435 x 171 x 378 mm (17-1/8" x 6-3/4" x 14-7/8")

Reference Dimensions (with wireless antenna upright)	
* Including legs and protrusions	
	435 x 248 x 378 mm (17-1/8" x 9-3/4" x 14-7/8")

Weight	
	10.5 kg (23.1 lbs)

\* The contents of this manual apply to the latest specifications as of the publishing date. To obtain the latest manual, access the Yamaha website then download the manual file.

## Default settings

### Default settings of the Option menu

The default settings of the “Option” menu are as follows.

Tone Control	Treble, Bass Bypass (0.0 dB)
* When both “Treble” and “Bass” are 0.0 dB, “Bypass” appears.	
YPAO Volume	
• YPAO Volume	Off
• Adaptive DRC	Off
Dialogue	
• Dialogue Level	0
• DTS Dialogue Control	0
• Dialogue Lift	0
(This setting is available only when one of the sound programs (except for 2ch Stereo and 7ch Stereo) is selected when presence speakers are used, or Virtual Presence Speaker (VPS) is working.)	
Lipsync	0 ms
Enhancer	
– TUNER, (network sources), AirPlay, SERVER, NET RADIO, Bluetooth, USB	On
– Others	Off
Volume Trim	
• Input Trim	0.0 dB
• Subwoofer Trim	0.0 dB
Extra Bass	Off

Video Processing	
• Video Mode	Direct
Video Out	Off
Shuffle / Repeat	
• Shuffle	Off
• Repeat	Off
FM Mode	Stereo

### Default settings of the Setup menu

The default settings of the “Setup” menu are as follows.

#### Speaker

Power Amp Assign	Basic
Configuration	
• Front	Small
• Center	Small
• Surround	Small
– Layout	Rear
• Surround Back	Small
• Front Presence	Small
– Layout	Front Height
• Crossover	80 Hz
• Subwoofer	Use
– Phase	Normal
Distance	3.00 m (10.0 ft)
Level	0.0 dB
Parametric EQ	Through

Test Tone	Off
YPAO Result	
• Result	-
<b>Sound</b>	
Information	-
Lipsync	
• Delay Enable	Enable
• Auto/Manual Select	Auto
• Adjustment	0 ms
DSP Parameter	-
Surround Decoder	
• Decode Type	Auto
• Center Spread	Off
• Center Image	0.3
7ch Stereo	
• Level	0
• Front / Rear Balance	0
• Left / Right Balance	0
• Height Balance	5
• Monaural Mix	Off
Dynamic Range	Maximum
Volume	
• Max Volume	+16.5 dB
• Initial Volume	Off
Adaptive DSP Level	On
Virtual Speaker	
• VSBS	On

## Scene

Scene Setting	-
Scene Rename	-

## Video/HDMI

Information	-
Video Mode	
• Video Mode	Direct
• Resolution	Auto
• Aspect	Through
HDMI Control	
• HDMI Control	Off
• TV Audio Input	AUDIO1
• ARC	On
• Standby Sync	Auto
HDMI Audio Output	
• HDMI OUT1	Off
• HDMI OUT2	Off
HDCP Version	
• HDMI 1-5	Auto
HDMI Standby Through	Off

## Network

Information	-
Network Connection	Wired
IP Address	
• DHCP	On
Network Standby	Auto
MAC Address Filter	
• Filter	Off

DMC Control	Enable
AirPlay Volume Interlock	Limited
Network Name	-
MusicCast Link Power Interlock	Off

## Bluetooth

Bluetooth	On
Audio Receive	
• Disconnect	-
• Bluetooth Standby	On

## Multi Zone

Information	-
Zone2	
• Volume	Variable
• Max Volume	+10.0 dB
• Initial Volume	Off
• Audio Delay	0 ms
• Monaural	Off
• Enhancer	On
• Tone Control	Auto
• Extra Bass	Off
• Left / Right Balance	0
Zone Rename	
• Main Zone	-
• Zone2	-
Party Mode Set	
• Target : Zone2	Enable

## System

Information	-
-------------	---

Language	English
Audio In	-
Input Skip	Off
Input Rename	
• HDMI 1-5	Auto
• Others	Manual
(For AV 2, AUX, AUDIO 4-5, PHONO, TUNER, MusicCast Link, SERVER, NET RADIO, Bluetooth, USB only "Manual" can be selected.)	
Auto Play	On
(Default setting may be different depending on the input source.)	
DSP Skip	Off
Remote Key	
• PROGRAM Key	Assign1
• Color Key	Default
Display Set	
• Dimmer (Front Display)	0
• Volume	dB
• Short Message	On
• Wallpaper	Piano
Trigger Output	
• Trigger Mode	Power
• Target Zone	All
ECO	
• Auto Power Standby	
– U.K., Europe, Russia and Korea models	20 minutes
– Other models	Off
• ECO Mode	Off
Memory Guard	Off

## Default settings of the ADVANCED SETUP menu

The default settings of the "ADVANCED SETUP" menu are as follows.

SP IMP.	8 Ω MIN
REMOTE ID	ID1
TU (Asia and General models only)	FM50/AM9
TV FORMAT	
• U.S.A., Canada, Korea and General models	NTSC
• Other models	PAL
MON.CHK	YES
4K MODE	MODE 1
DTS MODE	MODE 1
BKUP/RSTR	BKUP
INIT	CANCEL
UPDATE	USB
VERSION	-

Yamaha Global Site  
<https://www.yamaha.com/>

Yamaha Downloads  
<http://download.yamaha.com/>

Manual Development Group  
© 2018 Yamaha Corporation

Published 02/2018 NV-A0

AV17-0164